

GDCM  
3.0.10

Generated by Doxygen 1.9.1



---

<b>1 GDCM Documentation</b>	<b>1</b>
<b>2 Todo List</b>	<b>3</b>
<b>3 Deprecated List</b>	<b>5</b>
<b>4 Bug List</b>	<b>7</b>
<b>5 Namespace Index</b>	<b>9</b>
5.1 Namespace List . . . . .	9
<b>6 Hierarchical Index</b>	<b>11</b>
6.1 Class Hierarchy . . . . .	11
<b>7 Class Index</b>	<b>21</b>
7.1 Class List . . . . .	21
<b>8 File Index</b>	<b>35</b>
8.1 File List . . . . .	35
<b>9 Namespace Documentation</b>	<b>43</b>
9.1 gdcm Namespace Reference . . . . .	43
9.1.1 Detailed Description . . . . .	57
9.1.2 Typedef Documentation . . . . .	58
9.1.2.1 AECComp . . . . .	58
9.1.2.2 ASComp . . . . .	58
9.1.2.3 BOOL_FUNCTION_PFILE_PFILE_POINTER . . . . .	58
9.1.2.4 CSCComp . . . . .	58
9.1.2.5 DACComp . . . . .	58
9.1.2.6 DTComp . . . . .	58
9.1.2.7 FileList . . . . .	59
9.1.2.8 IconImage . . . . .	59
9.1.2.9 LOComp . . . . .	59
9.1.2.10 LTComp . . . . .	59
9.1.2.11 MacroEntry . . . . .	59
9.1.2.12 NestedMacroEntries . . . . .	59
9.1.2.13 PNComp . . . . .	59
9.1.2.14 SHComp . . . . .	60
9.1.2.15 STComp . . . . .	60
9.1.2.16 TMComp . . . . .	60
9.1.2.17 UCComp . . . . .	60
9.1.2.18 UIComp . . . . .	60

---

9.1.2.19 URComp . . . . .	60
9.1.2.20 UComp . . . . .	60
9.1.3 Enumeration Type Documentation . . . . .	60
9.1.3.1 CompOperators . . . . .	60
9.1.3.2 ECharSet . . . . .	61
9.1.3.3 ENQueryType . . . . .	61
9.1.3.4 EQueryLevel . . . . .	62
9.1.3.5 EQueryType . . . . .	62
9.1.3.6 ERootType . . . . .	62
9.1.3.7 LodModeType . . . . .	63
9.1.4 Function Documentation . . . . .	63
9.1.4.1 add1() . . . . .	63
9.1.4.2 backslash() . . . . .	63
9.1.4.3 Clamp() . . . . .	63
9.1.4.4 clean() . . . . .	64
9.1.4.5 doround() . . . . .	64
9.1.4.6 GetVRFromTag() . . . . .	64
9.1.4.7 operator"!=() [1/2] . . . . .	64
9.1.4.8 operator"!=() [2/2] . . . . .	64
9.1.4.9 operator<<() [1/56] . . . . .	65
9.1.4.10 operator<<() [2/56] . . . . .	65
9.1.4.11 operator<<() [3/56] . . . . .	65
9.1.4.12 operator<<() [4/56] . . . . .	65
9.1.4.13 operator<<() [5/56] . . . . .	65
9.1.4.14 operator<<() [6/56] . . . . .	65
9.1.4.15 operator<<() [7/56] . . . . .	66
9.1.4.16 operator<<() [8/56] . . . . .	66
9.1.4.17 operator<<() [9/56] . . . . .	66
9.1.4.18 operator<<() [10/56] . . . . .	66
9.1.4.19 operator<<() [11/56] . . . . .	66
9.1.4.20 operator<<() [12/56] . . . . .	66
9.1.4.21 operator<<() [13/56] . . . . .	67
9.1.4.22 operator<<() [14/56] . . . . .	67
9.1.4.23 operator<<() [15/56] . . . . .	67
9.1.4.24 operator<<() [16/56] . . . . .	67
9.1.4.25 operator<<() [17/56] . . . . .	67
9.1.4.26 operator<<() [18/56] . . . . .	68
9.1.4.27 operator<<() [19/56] . . . . .	68
9.1.4.28 operator<<() [20/56] . . . . .	68



---

9.1.4.29 operator<<() [21/56]	68
9.1.4.30 operator<<() [22/56]	68
9.1.4.31 operator<<() [23/56]	68
9.1.4.32 operator<<() [24/56]	69
9.1.4.33 operator<<() [25/56]	69
9.1.4.34 operator<<() [26/56]	69
9.1.4.35 operator<<() [27/56]	69
9.1.4.36 operator<<() [28/56]	69
9.1.4.37 operator<<() [29/56]	69
9.1.4.38 operator<<() [30/56]	70
9.1.4.39 operator<<() [31/56]	70
9.1.4.40 operator<<() [32/56]	70
9.1.4.41 operator<<() [33/56]	70
9.1.4.42 operator<<() [34/56]	70
9.1.4.43 operator<<() [35/56]	70
9.1.4.44 operator<<() [36/56]	71
9.1.4.45 operator<<() [37/56]	71
9.1.4.46 operator<<() [38/56]	71
9.1.4.47 operator<<() [39/56]	71
9.1.4.48 operator<<() [40/56]	71
9.1.4.49 operator<<() [41/56]	71
9.1.4.50 operator<<() [42/56]	72
9.1.4.51 operator<<() [43/56]	72
9.1.4.52 operator<<() [44/56]	72
9.1.4.53 operator<<() [45/56]	72
9.1.4.54 operator<<() [46/56]	72
9.1.4.55 operator<<() [47/56]	72
9.1.4.56 operator<<() [48/56]	73
9.1.4.57 operator<<() [49/56]	73
9.1.4.58 operator<<() [50/56]	73
9.1.4.59 operator<<() [51/56]	73
9.1.4.60 operator<<() [52/56]	73
9.1.4.61 operator<<() [53/56]	74
9.1.4.62 operator<<() [54/56]	74
9.1.4.63 operator<<() [55/56]	74
9.1.4.64 operator<<() [56/56]	74
9.1.4.65 operator==( )	74
9.1.4.66 operator>>() [1/3]	75
9.1.4.67 operator>>() [2/3]	75

---

9.1.4.68 operator>>() [3/3]	75
9.1.4.69 Round()	75
9.1.4.70 roundat()	75
9.1.4.71 TYPETOENCODING()	76
9.1.4.72 x16printf()	76
9.1.5 Variable Documentation	76
9.1.5.1 GlobalInstance	76
9.1.5.2 VRBINARY	76
9.2 gdcmm::network Namespace Reference	77
9.2.1 Enumeration Type Documentation	81
9.2.1.1 EEventID	81
9.2.1.2 EStateID	81
9.2.2 Function Documentation	83
9.2.2.1 GetStateIndex()	83
9.2.3 Variable Documentation	83
9.2.3.1 cMaxEventID	83
9.2.3.2 cMaxStateID	84
9.3 gdcmm::SegmentHelper Namespace Reference	84
9.4 gdcmm::terminal Namespace Reference	84
9.4.1 Detailed Description	85
9.4.2 Enumeration Type Documentation	85
9.4.2.1 Attribute	85
9.4.2.2 Color	85
9.4.2.3 Mode	86
9.4.3 Function Documentation	86
9.4.3.1 setattribute()	86
9.4.3.2 setbgcolor()	86
9.4.3.3 setfgcolor()	86
9.4.3.4 setmode()	86
<b>10 Class Documentation</b>	<b>87</b>
10.1 gdcmm::network::AAbortPDU Class Reference	87
10.1.1 Detailed Description	88
10.1.2 Constructor & Destructor Documentation	88
10.1.2.1 AAbortPDU()	88
10.1.3 Member Function Documentation	88
10.1.3.1 IsLastFragment()	88
10.1.3.2 Print()	88
10.1.3.3 Read()	89

10.1.3.4 SetReason()	89
10.1.3.5 SetSource()	89
10.1.3.6 Size()	89
10.1.3.7 Write()	89
10.2 gdcM::network::AAssociateACPDU Class Reference	90
10.2.1 Detailed Description	91
10.2.2 Member Typedef Documentation	91
10.2.2.1 SizeType	91
10.2.3 Constructor & Destructor Documentation	91
10.2.3.1 AAssociateACPDU()	92
10.2.4 Member Function Documentation	92
10.2.4.1 AddPresentationContextAC()	92
10.2.4.2 GetNumberOfPresentationContextAC()	92
10.2.4.3 GetPresentationContextAC()	92
10.2.4.4 GetUserInfoInformation()	92
10.2.4.5 InitFromRQ()	92
10.2.4.6 IsLastFragment()	93
10.2.4.7 Print()	93
10.2.4.8 Read()	93
10.2.4.9 SetCalledAETitle()	93
10.2.4.10 SetCallingAETitle()	93
10.2.4.11 Size()	93
10.2.4.12 Write()	94
10.2.5 Friends And Related Function Documentation	94
10.2.5.1 AAssociateRQPDU	94
10.3 gdcM::network::AAssociateRJPDU Class Reference	94
10.3.1 Detailed Description	95
10.3.2 Constructor & Destructor Documentation	95
10.3.2.1 AAssociateRJPDU()	95
10.3.3 Member Function Documentation	95
10.3.3.1 IsLastFragment()	96
10.3.3.2 Print()	96
10.3.3.3 Read()	96
10.3.3.4 Size()	96
10.3.3.5 Write()	96
10.4 gdcM::network::AAssociateRQPDU Class Reference	97
10.4.1 Detailed Description	98
10.4.2 Member Typedef Documentation	98
10.4.2.1 PresentationContextArrayType	99

---

10.4.2.2	SizeType	99
10.4.3	Constructor & Destructor Documentation	99
10.4.3.1	AAssociateRQPDU() [1/2]	99
10.4.3.2	AAssociateRQPDU() [2/2]	99
10.4.4	Member Function Documentation	99
10.4.4.1	AddPresentationContext()	99
10.4.4.2	GetCalledAETitle()	99
10.4.4.3	GetCallingAETitle()	100
10.4.4.4	GetNumberOfPresentationContext()	100
10.4.4.5	GetPresentationContext()	100
10.4.4.6	GetPresentationContextByAbstractSyntax()	100
10.4.4.7	GetPresentationContextByID()	100
10.4.4.8	GetPresentationContexts()	100
10.4.4.9	GetReserved43_74()	101
10.4.4.10	GetUserInformation()	101
10.4.4.11	IsAETitleValid()	101
10.4.4.12	IsLastFragment()	101
10.4.4.13	Print()	101
10.4.4.14	Read()	102
10.4.4.15	SetCalledAETitle()	102
10.4.4.16	SetCallingAETitle()	102
10.4.4.17	SetUserInformation()	102
10.4.4.18	Size()	102
10.4.4.19	Write()	103
10.4.5	Friends And Related Function Documentation	103
10.4.5.1	AAssociateACPDU	103
10.5	gdcM::AbortEvent Class Reference	103
10.6	gdcM::network::AbstractSyntax Class Reference	104
10.6.1	Detailed Description	105
10.6.2	Constructor & Destructor Documentation	105
10.6.2.1	AbstractSyntax()	105
10.6.3	Member Function Documentation	105
10.6.3.1	GetAsDataElement()	105
10.6.3.2	GetName()	105
10.6.3.3	operator==(())	105
10.6.3.4	Print()	105
10.6.3.5	Read()	106
10.6.3.6	SetName()	106
10.6.3.7	SetNameFromUID()	106

---

10.6.3.8	Size()	106
10.6.3.9	Write()	106
10.7	gdcm::AnonymizeEvent Class Reference	107
10.7.1	Detailed Description	108
10.7.2	Member Typedef Documentation	108
10.7.2.1	Self	108
10.7.2.2	Superclass	108
10.7.3	Constructor & Destructor Documentation	108
10.7.3.1	AnonymizeEvent() [1/2]	109
10.7.3.2	~AnonymizeEvent()	109
10.7.3.3	AnonymizeEvent() [2/2]	109
10.7.4	Member Function Documentation	109
10.7.4.1	CheckEvent()	109
10.7.4.2	GetEventName()	109
10.7.4.3	GetTag()	109
10.7.4.4	MakeObject()	110
10.7.4.5	operator=()	110
10.7.4.6	SetTag()	110
10.8	gdcm::Anonymizer Class Reference	110
10.8.1	Detailed Description	112
10.8.2	Constructor & Destructor Documentation	113
10.8.2.1	Anonymizer()	113
10.8.2.2	~Anonymizer()	113
10.8.3	Member Function Documentation	113
10.8.3.1	BALCPPProtect()	113
10.8.3.2	BasicApplicationLevelConfidentialityProfile()	114
10.8.3.3	CanEmptyTag()	114
10.8.3.4	ClearInternalUIDs()	114
10.8.3.5	Empty()	114
10.8.3.6	GetBasicApplicationLevelConfidentialityProfileAttributes()	115
10.8.3.7	GetCryptographicMessageSyntax()	115
10.8.3.8	GetFile()	115
10.8.3.9	New()	115
10.8.3.10	RecurseDataSet()	115
10.8.3.11	Remove()	115
10.8.3.12	RemoveGroupLength()	116
10.8.3.13	RemovePrivateTags()	116
10.8.3.14	RemoveRetired()	116
10.8.3.15	Replace() [1/2]	116

---

10.8.3.16 Replace() [2/2]	117
10.8.3.17 SetCryptographicMessageSyntax()	117
10.8.3.18 SetFile()	117
10.9 gdcM::AnyEvent Class Reference	118
10.10 gdcM::network::ApplicationContext Class Reference	119
10.10.1 Detailed Description	119
10.10.2 Constructor & Destructor Documentation	120
10.10.2.1 ApplicationContext()	120
10.10.3 Member Function Documentation	120
10.10.3.1 GetName()	120
10.10.3.2 Print()	120
10.10.3.3 Read()	120
10.10.3.4 SetName()	120
10.10.3.5 Size()	121
10.10.3.6 Write()	121
10.11 gdcM::ApplicationEntity Class Reference	121
10.11.1 Detailed Description	122
10.11.2 Member Function Documentation	122
10.11.2.1 IsValid()	122
10.11.2.2 Print()	122
10.11.2.3 SetBlob()	123
10.11.2.4 Squeeze()	123
10.11.3 Member Data Documentation	123
10.11.3.1 Internal	123
10.11.3.2 MaxLength	123
10.11.3.3 MaxNumberOfComponents	123
10.11.3.4 Padding	123
10.11.3.5 Separator	124
10.12 gdcM::network::AReleaseRPPDU Class Reference	124
10.12.1 Detailed Description	125
10.12.2 Constructor & Destructor Documentation	125
10.12.2.1 AReleaseRPPDU()	125
10.12.3 Member Function Documentation	125
10.12.3.1 IsLastFragment()	125
10.12.3.2 Print()	125
10.12.3.3 Read()	126
10.12.3.4 Size()	126
10.12.3.5 Write()	126
10.13 gdcM::network::AReleaseRQPDU Class Reference	126

---

10.13.1 Detailed Description	127
10.13.2 Constructor & Destructor Documentation	127
10.13.2.1 AReleaseRQPDU()	127
10.13.3 Member Function Documentation	127
10.13.3.1 IsLastFragment()	128
10.13.3.2 Print()	128
10.13.3.3 Read()	128
10.13.3.4 Size()	128
10.13.3.5 Write()	128
10.14 gdcmm::network::ARTIMTimer Class Reference	129
10.14.1 Detailed Description	129
10.14.2 Constructor & Destructor Documentation	129
10.14.2.1 ARTIMTimer()	129
10.14.3 Member Function Documentation	129
10.14.3.1 GetElapsedTime()	130
10.14.3.2 GetHasExpired()	130
10.14.3.3 GetTimeout()	130
10.14.3.4 SetTimeout()	130
10.14.3.5 Start()	130
10.14.3.6 Stop()	130
10.15 gdcmm::ASN1 Class Reference	130
10.15.1 Detailed Description	131
10.15.2 Constructor & Destructor Documentation	131
10.15.2.1 ASN1() [1/2]	131
10.15.2.2 ~ASN1()	131
10.15.2.3 ASN1() [2/2]	131
10.15.3 Member Function Documentation	132
10.15.3.1 operator=()	132
10.15.3.2 ParseDump()	132
10.15.3.3 ParseDumpFile()	132
10.15.3.4 TestPBKDF2()	132
10.16 gdcmm::network::AsynchronousOperationsWindowSub Class Reference	132
10.16.1 Detailed Description	133
10.16.2 Constructor & Destructor Documentation	133
10.16.2.1 AsynchronousOperationsWindowSub()	133
10.16.3 Member Function Documentation	133
10.16.3.1 Print()	133
10.16.3.2 Read()	133
10.16.3.3 Size()	134

---

10.16.3.4 Write()	134
10.17 gdcM::Attribute< Group, Element, TVR, TVM > Class Template Reference	134
10.17.1 Detailed Description	136
10.17.2 Member Typedef Documentation	136
10.17.2.1 ArrayType	136
10.17.3 Member Enumeration Documentation	136
10.17.3.1 anonymous enum	136
10.17.4 Member Function Documentation	137
10.17.4.1 GDCM_STATIC_ASSERT() [1/3]	137
10.17.4.2 GDCM_STATIC_ASSERT() [2/3]	137
10.17.4.3 GDCM_STATIC_ASSERT() [3/3]	137
10.17.4.4 GetAsDataElement()	137
10.17.4.5 GetDictVM()	138
10.17.4.6 GetDictVR()	138
10.17.4.7 GetNumberOfValues()	138
10.17.4.8 GetTag()	138
10.17.4.9 GetValue() [1/2]	139
10.17.4.10 GetValue() [2/2]	139
10.17.4.11 GetValues()	139
10.17.4.12 GetVM()	139
10.17.4.13 GetVR()	140
10.17.4.14 operator!=()	140
10.17.4.15 operator<()	140
10.17.4.16 operator==()	140
10.17.4.17 operator[]() [1/2]	140
10.17.4.18 operator[]() [2/2]	141
10.17.4.19 Print()	141
10.17.4.20 Set()	141
10.17.4.21 SetByteValue()	141
10.17.4.22 SetByteValueNoSwap()	142
10.17.4.23 SetFromDataElement()	142
10.17.4.24 SetFromDataSet()	142
10.17.4.25 SetValue()	143
10.17.4.26 SetValues()	143
10.17.5 Member Data Documentation	143
10.17.5.1 Internal	143
10.18 gdcM::Attribute< Group, Element, TVR, VM::VM1 > Class Template Reference	144
10.18.1 Member Typedef Documentation	145
10.18.1.1 ArrayType	145



---

10.18.2 Member Enumeration Documentation	145
10.18.2.1 anonymous enum	145
10.18.3 Member Function Documentation	146
10.18.3.1 GDCM_STATIC_ASSERT() [1/4]	146
10.18.3.2 GDCM_STATIC_ASSERT() [2/4]	146
10.18.3.3 GDCM_STATIC_ASSERT() [3/4]	146
10.18.3.4 GDCM_STATIC_ASSERT() [4/4]	146
10.18.3.5 GetAsDataElement()	147
10.18.3.6 GetDictVM()	147
10.18.3.7 GetDictVR()	147
10.18.3.8 GetNumberOfValues()	147
10.18.3.9 GetTag()	147
10.18.3.10 GetValue() [1/2]	147
10.18.3.11 GetValue() [2/2]	148
10.18.3.12 GetValues()	148
10.18.3.13 GetVM()	148
10.18.3.14 GetVR()	148
10.18.3.15 operator!=(=)	148
10.18.3.16 operator<()	148
10.18.3.17 operator==(=)	149
10.18.3.18 Print()	149
10.18.3.19 Set()	149
10.18.3.20 SetByteValue()	149
10.18.3.21 SetByteValueNoSwap()	149
10.18.3.22 SetFromDataElement()	150
10.18.3.23 SetFromDataSet()	150
10.18.3.24 SetValue()	150
10.18.4 Member Data Documentation	150
10.18.4.1 Internal	150
10.19 gdcM::Attribute< Group, Element, TVR, VM::VM1_3 > Class Template Reference	151
10.19.1 Member Function Documentation	151
10.19.1.1 GetVM()	152
10.20 gdcM::Attribute< Group, Element, TVR, VM::VM1_8 > Class Template Reference	152
10.20.1 Member Function Documentation	153
10.20.1.1 GetVM()	153
10.21 gdcM::Attribute< Group, Element, TVR, VM::VM1_n > Class Template Reference	153
10.21.1 Member Typedef Documentation	154
10.21.1.1 ArrayType	154
10.21.2 Constructor & Destructor Documentation	155

---

10.21.2.1	Attribute()	155
10.21.2.2	~Attribute()	155
10.21.3	Member Function Documentation	155
10.21.3.1	GDCM_STATIC_ASSERT() [1/3]	155
10.21.3.2	GDCM_STATIC_ASSERT() [2/3]	155
10.21.3.3	GDCM_STATIC_ASSERT() [3/3]	155
10.21.3.4	GetAsDataElement()	156
10.21.3.5	GetDictVM()	156
10.21.3.6	GetDictVR()	156
10.21.3.7	GetNumberOfValues()	156
10.21.3.8	GetTag()	156
10.21.3.9	GetValue() [1/2]	156
10.21.3.10	GetValue() [2/2]	157
10.21.3.11	GetValues()	157
10.21.3.12	GetVM()	157
10.21.3.13	GetVR()	157
10.21.3.14	operator[]() [1/2]	157
10.21.3.15	operator[]() [2/2]	157
10.21.3.16	Print()	158
10.21.3.17	Set()	158
10.21.3.18	SetByteValue()	158
10.21.3.19	SetFromDataElement()	158
10.21.3.20	SetFromDataSet()	158
10.21.3.21	SetNumberOfValues()	159
10.21.3.22	SetValue() [1/2]	159
10.21.3.23	SetValue() [2/2]	159
10.21.3.24	SetValues()	159
10.22	gdcM::Attribute< Group, Element, TVR, VM::VM2_2n > Class Template Reference	160
10.22.1	Member Function Documentation	161
10.22.1.1	GetVM()	161
10.23	gdcM::Attribute< Group, Element, TVR, VM::VM2_n > Class Template Reference	161
10.23.1	Member Function Documentation	162
10.23.1.1	GetVM()	162
10.24	gdcM::Attribute< Group, Element, TVR, VM::VM3_3n > Class Template Reference	163
10.24.1	Member Function Documentation	164
10.24.1.1	GetVM()	164
10.25	gdcM::Attribute< Group, Element, TVR, VM::VM3_n > Class Template Reference	164
10.25.1	Member Function Documentation	165
10.25.1.1	GetVM()	165

---

10.26 gdcM::AudioCodec Class Reference	166
10.26.1 Detailed Description	167
10.26.2 Constructor & Destructor Documentation	167
10.26.2.1 AudioCodec()	167
10.26.2.2 ~AudioCodec()	167
10.26.3 Member Function Documentation	167
10.26.3.1 CanCode()	167
10.26.3.2 CanDecode()	168
10.26.3.3 Decode()	168
10.27 gdcM::Base64 Class Reference	168
10.27.1 Detailed Description	169
10.27.2 Constructor & Destructor Documentation	169
10.27.2.1 Base64()	169
10.27.3 Member Function Documentation	169
10.27.3.1 Decode()	169
10.27.3.2 Encode()	170
10.27.3.3 GetDecodeLength()	170
10.27.3.4 GetEncodeLength()	170
10.27.3.5 operator=()	171
10.28 gdcM::network::BaseCompositeMessage Class Reference	171
10.28.1 Detailed Description	172
10.28.2 Constructor & Destructor Documentation	172
10.28.2.1 ~BaseCompositeMessage()	172
10.28.3 Member Function Documentation	172
10.28.3.1 ConstructPDV()	172
10.29 gdcM::network::BaseNormalizedMessage Class Reference	173
10.29.1 Detailed Description	174
10.29.2 Constructor & Destructor Documentation	174
10.29.2.1 ~BaseNormalizedMessage()	174
10.29.3 Member Function Documentation	174
10.29.3.1 ConstructPDV()	174
10.30 gdcM::network::BasePDU Class Reference	175
10.30.1 Detailed Description	175
10.30.2 Constructor & Destructor Documentation	176
10.30.2.1 ~BasePDU()	176
10.30.3 Member Function Documentation	176
10.30.3.1 IsLastFragment()	176
10.30.3.2 Print()	176
10.30.3.3 Read()	177

---

10.30.3.4	Size()	177
10.30.3.5	Write()	177
10.31	gdcm::BaseQuery Class Reference	177
10.31.1	Detailed Description	179
10.31.2	Constructor & Destructor Documentation	179
10.31.2.1	BaseQuery()	179
10.31.2.2	~BaseQuery()	179
10.31.3	Member Function Documentation	179
10.31.3.1	AddQueryDataSet()	180
10.31.3.2	GetAbstractSyntaxUID()	180
10.31.3.3	GetQueryDataSet() [1/2]	180
10.31.3.4	GetQueryDataSet() [2/2]	180
10.31.3.5	GetSOPInstanceUID()	180
10.31.3.6	Print()	180
10.31.3.7	SetSearchParameter() [1/3]	181
10.31.3.8	SetSearchParameter() [2/3]	181
10.31.3.9	SetSearchParameter() [3/3]	181
10.31.3.10	SetSOPInstanceUID()	181
10.31.3.11	ValidateQuery()	181
10.31.3.12	ValidDataSet()	182
10.31.3.13	WriteHelpFile()	182
10.31.3.14	WriteQuery()	182
10.31.4	Friends And Related Function Documentation	182
10.31.4.1	QueryFactory	182
10.31.5	Member Data Documentation	182
10.31.5.1	mDataSet	182
10.31.5.2	mSopInstanceUID	183
10.32	gdcm::BaseRootQuery Class Reference	183
10.32.1	Detailed Description	184
10.32.2	Constructor & Destructor Documentation	185
10.32.2.1	BaseRootQuery()	185
10.32.2.2	~BaseRootQuery()	185
10.32.3	Member Function Documentation	185
10.32.3.1	Construct()	185
10.32.3.2	GetQueryLevelFromQueryRoot()	185
10.32.3.3	GetQueryLevelFromString()	185
10.32.3.4	GetQueryLevelString()	186
10.32.3.5	GetTagListByLevel()	186
10.32.3.6	InitializeDataSet()	186

---

10.32.3.7 ValidateQuery()	186
10.32.4 Friends And Related Function Documentation	187
10.32.4.1 QueryFactory	187
10.32.5 Member Data Documentation	187
10.32.5.1 mHelpDescription	187
10.32.5.2 mImage	187
10.32.5.3 mPatient	187
10.32.5.4 mRootType	187
10.32.5.5 mSeries	187
10.32.5.6 mStudy	188
10.33 gdcM::SegmentHelper::BasicCodedEntry Struct Reference	188
10.33.1 Detailed Description	189
10.33.2 Constructor & Destructor Documentation	189
10.33.2.1 BasicCodedEntry() [1/3]	189
10.33.2.2 BasicCodedEntry() [2/3]	189
10.33.2.3 BasicCodedEntry() [3/3]	190
10.33.3 Member Function Documentation	190
10.33.3.1 IsEmpty()	190
10.33.4 Member Data Documentation	190
10.33.4.1 CM	190
10.33.4.2 CSD	190
10.33.4.3 CSV	191
10.33.4.4 CV	191
10.34 gdcM::BasicOffsetTable Class Reference	191
10.34.1 Detailed Description	192
10.34.2 Constructor & Destructor Documentation	192
10.34.2.1 BasicOffsetTable()	193
10.34.3 Member Function Documentation	193
10.34.3.1 Read()	193
10.34.4 Friends And Related Function Documentation	193
10.34.4.1 operator<<	193
10.35 gdcM::Bitmap Class Reference	194
10.35.1 Detailed Description	196
10.35.2 Member Typedef Documentation	197
10.35.2.1 LUTPtr	197
10.35.3 Constructor & Destructor Documentation	197
10.35.3.1 Bitmap()	197
10.35.3.2 ~Bitmap()	197
10.35.4 Member Function Documentation	197

---

10.35.4.1 AreOverlaysInPixelData()	197
10.35.4.2 Clear()	197
10.35.4.3 ComputeLossyFlag()	198
10.35.4.4 GetBuffer()	198
10.35.4.5 GetBuffer2()	198
10.35.4.6 GetBufferLength()	198
10.35.4.7 GetColumns()	198
10.35.4.8 GetDataElement() [1/2]	199
10.35.4.9 GetDataElement() [2/2]	199
10.35.4.10 GetDimension()	199
10.35.4.11 GetDimensions()	199
10.35.4.12 GetLUT() [1/2]	199
10.35.4.13 GetLUT() [2/2]	200
10.35.4.14 GetNeedByteSwap()	200
10.35.4.15 GetNumberOfDimensions()	200
10.35.4.16 GetPhotometricInterpretation()	200
10.35.4.17 GetPixelFormat() [1/2]	201
10.35.4.18 GetPixelFormat() [2/2]	201
10.35.4.19 GetPlanarConfiguration()	201
10.35.4.20 GetRows()	201
10.35.4.21 GetTransferSyntax()	201
10.35.4.22 IsEmpty()	202
10.35.4.23 IsLossy()	202
10.35.4.24 IsTransferSyntaxCompatible()	202
10.35.4.25 Print()	202
10.35.4.26 SetColumns()	202
10.35.4.27 SetDataElement()	203
10.35.4.28 SetDimension()	203
10.35.4.29 SetDimensions()	203
10.35.4.30 SetLossyFlag()	203
10.35.4.31 SetLUT()	204
10.35.4.32 SetNeedByteSwap()	204
10.35.4.33 SetNumberOfDimensions()	204
10.35.4.34 SetPhotometricInterpretation()	204
10.35.4.35 SetPixelFormat()	205
10.35.4.36 SetPlanarConfiguration()	205
10.35.4.37 SetRows()	205
10.35.4.38 SetTransferSyntax()	205
10.35.4.39 TryJPEG2000Codec()	206

---

10.35.4.40 TryJPEG2000Codec2()	206
10.35.4.41 TryJPEGCodec()	206
10.35.4.42 TryJPEGCodec2()	206
10.35.4.43 TryJPEGLSCodec()	206
10.35.4.44 TryKAKADUCodec()	206
10.35.4.45 TryPVRGCodec()	207
10.35.4.46 TryRAWCodec()	207
10.35.4.47 TryRLECodec()	207
10.35.4.48 UnusedBitsPresentInPixelData()	207
10.35.5 Friends And Related Function Documentation	207
10.35.5.1 ImageChangeTransferSyntax	207
10.35.5.2 PixmapReader	207
10.35.6 Member Data Documentation	208
10.35.6.1 Dimensions	208
10.35.6.2 LossyFlag	208
10.35.6.3 LUT	208
10.35.6.4 NeedByteSwap	208
10.35.6.5 NumberOfDimensions	208
10.35.6.6 PF	208
10.35.6.7 PI	209
10.35.6.8 PixelData	209
10.35.6.9 PlanarConfiguration	209
10.35.6.10 TS	209
10.36 gdcM::BitmapToBitmapFilter Class Reference	209
10.36.1 Detailed Description	210
10.36.2 Constructor & Destructor Documentation	211
10.36.2.1 BitmapToBitmapFilter()	211
10.36.2.2 ~BitmapToBitmapFilter()	211
10.36.3 Member Function Documentation	211
10.36.3.1 GetOutput()	211
10.36.3.2 GetOutputAsBitmap()	211
10.36.3.3 SetInput()	211
10.36.4 Member Data Documentation	212
10.36.4.1 Input	212
10.36.4.2 Output	212
10.37 gdcM::BoxRegion Class Reference	212
10.37.1 Detailed Description	214
10.37.2 Constructor & Destructor Documentation	214
10.37.2.1 BoxRegion() [1/2]	214

---

10.37.2.2	~BoxRegion()	214
10.37.2.3	BoxRegion() [2/2]	214
10.37.3	Member Function Documentation	214
10.37.3.1	Area()	214
10.37.3.2	BoundingBox()	215
10.37.3.3	Clone()	215
10.37.3.4	ComputeBoundingBox()	215
10.37.3.5	Empty()	215
10.37.3.6	GetXMax()	215
10.37.3.7	GetXMin()	216
10.37.3.8	GetYMax()	216
10.37.3.9	GetYMin()	216
10.37.3.10	GetZMax()	216
10.37.3.11	GetZMin()	216
10.37.3.12	IsValid()	216
10.37.3.13	operator=()	217
10.37.3.14	Print()	217
10.37.3.15	SetDomain()	217
10.38	gdcM::ByteBuffer Class Reference	217
10.38.1	Detailed Description	218
10.38.2	Constructor & Destructor Documentation	218
10.38.2.1	ByteBuffer()	218
10.38.3	Member Function Documentation	218
10.38.3.1	Get()	218
10.38.3.2	GetStart()	218
10.38.3.3	ShiftEnd()	218
10.38.3.4	UpdatePosition()	219
10.39	gdcM::ByteSwap< T > Class Template Reference	219
10.39.1	Detailed Description	219
10.39.2	Member Function Documentation	219
10.39.2.1	Swap()	220
10.39.2.2	SwapFromSwapCodeIntoSystem()	220
10.39.2.3	SwapRange()	220
10.39.2.4	SwapRangeFromSwapCodeIntoSystem()	220
10.39.2.5	SystemIsBigEndian()	221
10.39.2.6	SystemIsLittleEndian()	221
10.40	gdcM::ByteSwapFilter Class Reference	221
10.40.1	Detailed Description	221
10.40.2	Constructor & Destructor Documentation	221



---

10.40.2.1 ByteSwapFilter() [1/2]	222
10.40.2.2 ~ByteSwapFilter()	222
10.40.2.3 ByteSwapFilter() [2/2]	222
10.40.3 Member Function Documentation	222
10.40.3.1 ByteSwap()	222
10.40.3.2 operator=()	222
10.40.3.3 SetByteSwapTag()	222
10.41 gdcm::ByteValue Class Reference	223
10.41.1 Detailed Description	225
10.41.2 Constructor & Destructor Documentation	225
10.41.2.1 ByteValue() [1/2]	225
10.41.2.2 ByteValue() [2/2]	225
10.41.2.3 ~ByteValue()	225
10.41.3 Member Function Documentation	226
10.41.3.1 Append()	226
10.41.3.2 Clear()	226
10.41.3.3 ComputeLength()	226
10.41.3.4 Fill()	226
10.41.3.5 GetBuffer()	226
10.41.3.6 GetLength()	227
10.41.3.7 GetPointer()	227
10.41.3.8 GetVoidPointer() [1/2]	227
10.41.3.9 GetVoidPointer() [2/2]	228
10.41.3.10 IsEmpty()	228
10.41.3.11 IsPrintable()	228
10.41.3.12 operator const std::vector< char > &()	228
10.41.3.13 operator=()	228
10.41.3.14 operator==( [1/2]	229
10.41.3.15 operator==( [2/2]	229
10.41.3.16 Print()	229
10.41.3.17 PrintASCII()	229
10.41.3.18 PrintASCIIXML()	229
10.41.3.19 PrintGroupLength()	229
10.41.3.20 PrintHex()	230
10.41.3.21 PrintHexXML()	230
10.41.3.22 PrintPNXML()	230
10.41.3.23 Read() [1/2]	230
10.41.3.24 Read() [2/2]	230
10.41.3.25 SetLength()	230

---

10.41.3.26 SetLengthOnly()	231
10.41.3.27 Write() [1/2]	231
10.41.3.28 Write() [2/2]	231
10.41.3.29 WriteBuffer()	231
10.42 gdcM::CAPICryptoFactory Class Reference	232
10.42.1 Constructor & Destructor Documentation	232
10.42.1.1 CAPICryptoFactory()	233
10.42.2 Member Function Documentation	233
10.42.2.1 CreateCMSProvider()	233
10.43 gdcM::CAPICryptographicMessageSyntax Class Reference	233
10.43.1 Constructor & Destructor Documentation	234
10.43.1.1 CAPICryptographicMessageSyntax()	234
10.43.1.2 ~CAPICryptographicMessageSyntax()	235
10.43.2 Member Function Documentation	235
10.43.2.1 Decrypt()	235
10.43.2.2 Encrypt()	235
10.43.2.3 GetCipherType()	235
10.43.2.4 GetInitialized()	236
10.43.2.5 ParseCertificateFile()	236
10.43.2.6 ParseKeyFile()	236
10.43.2.7 SetCipherType()	236
10.43.2.8 SetPassword()	236
10.44 gdcM::network::CEchoRQ Class Reference	237
10.44.1 Detailed Description	238
10.44.2 Member Function Documentation	238
10.44.2.1 ConstructPDV()	238
10.44.3 Member Data Documentation	238
10.44.3.1 AffectedSOPClassUID	238
10.44.3.2 MessageID	238
10.45 gdcM::network::CEchoRSP Class Reference	239
10.45.1 Detailed Description	239
10.45.2 Member Function Documentation	240
10.45.2.1 ConstructPDVByDataSet()	240
10.46 gdcM::network::CFind Class Reference	240
10.46.1 Detailed Description	240
10.47 gdcM::network::CFindCancelRQ Class Reference	240
10.47.1 Detailed Description	241
10.47.2 Member Function Documentation	241
10.47.2.1 ConstructPDVByDataSet()	241

---

10.48	gdcM::network::CFindRQ Class Reference	242
10.48.1	Detailed Description	242
10.48.2	Member Function Documentation	243
10.48.2.1	ConstructPDV()	243
10.49	gdcM::network::CFindRSP Class Reference	243
10.49.1	Detailed Description	244
10.49.2	Member Function Documentation	244
10.49.2.1	ConstructPDVByDataSet()	244
10.50	gdcM::network::CMoveCancelRq Class Reference	245
10.50.1	Member Function Documentation	245
10.50.1.1	ConstructPDVByDataSet()	246
10.51	gdcM::network::CMoveRQ Class Reference	246
10.51.1	Detailed Description	247
10.51.2	Member Function Documentation	247
10.51.2.1	ConstructPDV()	247
10.52	gdcM::network::CMoveRSP Class Reference	247
10.52.1	Detailed Description	248
10.52.2	Member Function Documentation	248
10.52.2.1	ConstructPDVByDataSet()	248
10.53	gdcM::Codec Class Reference	249
10.53.1	Detailed Description	249
10.54	gdcM::Coder Class Reference	250
10.54.1	Detailed Description	250
10.54.2	Constructor & Destructor Documentation	250
10.54.2.1	~Coder()	251
10.54.3	Member Function Documentation	251
10.54.3.1	CanCode()	251
10.54.3.2	Code()	251
10.54.3.3	InternalCode()	251
10.55	gdcM::CodeString Class Reference	252
10.55.1	Detailed Description	253
10.55.2	Member Typedef Documentation	253
10.55.2.1	const_iterator	253
10.55.2.2	const_reference	253
10.55.2.3	const_reverse_iterator	253
10.55.2.4	difference_type	253
10.55.2.5	iterator	254
10.55.2.6	pointer	254
10.55.2.7	reference	254

---

10.55.2.8 reverse_iterator	254
10.55.2.9 size_type	254
10.55.2.10 value_type	254
10.55.3 Constructor & Destructor Documentation	254
10.55.3.1 CodeString() [1/4]	255
10.55.3.2 CodeString() [2/4]	255
10.55.3.3 CodeString() [3/4]	255
10.55.3.4 CodeString() [4/4]	255
10.55.4 Member Function Documentation	255
10.55.4.1 GetAsString()	255
10.55.4.2 IsValid()	256
10.55.4.3 Size()	256
10.55.4.4 TrimInternal()	256
10.55.5 Friends And Related Function Documentation	256
10.55.5.1 operator"!="	256
10.55.5.2 operator<<	256
10.55.5.3 operator==	257
10.56 gdcM::Command Class Reference	257
10.56.1 Detailed Description	258
10.56.2 Constructor & Destructor Documentation	258
10.56.2.1 Command() [1/2]	259
10.56.2.2 Command() [2/2]	259
10.56.2.3 ~Command()	259
10.56.3 Member Function Documentation	259
10.56.3.1 Execute() [1/2]	259
10.56.3.2 Execute() [2/2]	259
10.56.3.3 operator=()	260
10.57 gdcM::CommandDataSet Class Reference	260
10.57.1 Detailed Description	261
10.57.2 Constructor & Destructor Documentation	261
10.57.2.1 CommandDataSet()	261
10.57.2.2 ~CommandDataSet()	261
10.57.3 Member Function Documentation	261
10.57.3.1 Insert()	262
10.57.3.2 Read()	262
10.57.3.3 Replace()	262
10.57.3.4 Write()	262
10.57.4 Friends And Related Function Documentation	262
10.57.4.1 operator<<	262

---

10.58 gdcM::network::CompositeMessageFactory Class Reference	263
10.58.1 Detailed Description	263
10.58.2 Member Function Documentation	263
10.58.2.1 ConstructCEchoRQ()	263
10.58.2.2 ConstructCFindRQ()	263
10.58.2.3 ConstructCMoveRQ()	264
10.58.2.4 ConstructCStoreRQ()	264
10.58.2.5 ConstructCStoreRSP()	264
10.59 gdcM::CompositeNetworkFunctions Class Reference	264
10.59.1 Detailed Description	265
10.59.2 Member Typedef Documentation	265
10.59.2.1 KeyValuePairArrayType	265
10.59.2.2 KeyValuePairType	265
10.59.3 Member Function Documentation	266
10.59.3.1 CEcho()	266
10.59.3.2 CFind()	266
10.59.3.3 CMove()	267
10.59.3.4 ConstructQuery() [1/2]	267
10.59.3.5 ConstructQuery() [2/2]	268
10.59.3.6 CStore()	268
10.60 gdcM::ConstCharWrapper Class Reference	269
10.60.1 Detailed Description	269
10.60.2 Constructor & Destructor Documentation	269
10.60.2.1 ConstCharWrapper()	269
10.60.3 Member Function Documentation	269
10.60.3.1 operator const char *()	269
10.61 gdcM::CP246ExplicitDataElement Class Reference	270
10.61.1 Detailed Description	271
10.61.2 Member Function Documentation	271
10.61.2.1 GetLength()	271
10.61.2.2 Read()	271
10.61.2.3 ReadPreValue()	271
10.61.2.4 ReadValue()	272
10.61.2.5 ReadWithLength()	272
10.62 gdcM::CryptoFactory Class Reference	272
10.62.1 Detailed Description	273
10.62.2 Member Enumeration Documentation	273
10.62.2.1 CryptoLib	273
10.62.3 Constructor & Destructor Documentation	274

---

10.62.3.1 CryptoFactory() [1/2]	274
10.62.3.2 CryptoFactory() [2/2]	274
10.62.3.3 ~CryptoFactory()	274
10.62.4 Member Function Documentation	274
10.62.4.1 CreateCMSProvider()	274
10.62.4.2 GetFactoryInstance()	274
10.63 gdcM::CryptographicMessageSyntax Class Reference	275
10.63.1 Member Enumeration Documentation	275
10.63.1.1 CipherTypes	275
10.63.2 Constructor & Destructor Documentation	276
10.63.2.1 CryptographicMessageSyntax() [1/2]	276
10.63.2.2 ~CryptographicMessageSyntax()	276
10.63.2.3 CryptographicMessageSyntax() [2/2]	276
10.63.3 Member Function Documentation	276
10.63.3.1 Decrypt()	276
10.63.3.2 Encrypt()	277
10.63.3.3 GetCipherType()	277
10.63.3.4 operator=()	277
10.63.3.5 ParseCertificateFile()	277
10.63.3.6 ParseKeyFile()	277
10.63.3.7 SetCipherType()	278
10.63.3.8 SetPassword()	278
10.64 gdcM::CSAElement Class Reference	278
10.64.1 Detailed Description	280
10.64.2 Member Typedef Documentation	280
10.64.2.1 DataPtr	280
10.64.3 Constructor & Destructor Documentation	280
10.64.3.1 CSAElement() [1/2]	280
10.64.3.2 CSAElement() [2/2]	280
10.64.4 Member Function Documentation	281
10.64.4.1 GetByteValue()	281
10.64.4.2 GetKey()	281
10.64.4.3 GetName()	281
10.64.4.4 GetNoOfItems()	281
10.64.4.5 GetSyngoDT()	282
10.64.4.6 GetValue() [1/2]	282
10.64.4.7 GetValue() [2/2]	282
10.64.4.8 GetVM()	282
10.64.4.9 GetVR()	282

10.64.4.10 IsEmpty()	283
10.64.4.11 operator<()	283
10.64.4.12 operator=()	283
10.64.4.13 operator==(())	283
10.64.4.14 SetByteValue()	283
10.64.4.15 SetKey()	284
10.64.4.16 SetName()	284
10.64.4.17 SetNoOfItems()	284
10.64.4.18 SetSyngoDT()	284
10.64.4.19 SetValue()	284
10.64.4.20 SetVM()	284
10.64.4.21 SetVR()	285
10.64.5 Friends And Related Function Documentation	285
10.64.5.1 operator<<	285
10.64.6 Member Data Documentation	285
10.64.6.1 DataField	285
10.64.6.2 KeyField	285
10.64.6.3 NameField	285
10.64.6.4 NoOfItemsField	286
10.64.6.5 SyngoDTField	286
10.64.6.6 ValueMultiplicityField	286
10.64.6.7 VRField	286
10.65 gdcM::CSAHeader Class Reference	286
10.65.1 Detailed Description	287
10.65.2 Member Enumeration Documentation	288
10.65.2.1 CSAHeaderType	288
10.65.3 Constructor & Destructor Documentation	288
10.65.3.1 CSAHeader()	289
10.65.3.2 ~CSAHeader()	289
10.65.4 Member Function Documentation	289
10.65.4.1 FindCSAElementByName()	289
10.65.4.2 GetCSADataInfo()	289
10.65.4.3 GetCSAEEnd()	289
10.65.4.4 GetCSAElementByName()	290
10.65.4.5 GetCSAImageHeaderInfoTag()	290
10.65.4.6 GetCSASeriesHeaderInfoTag()	290
10.65.4.7 GetDataSet()	291
10.65.4.8 GetFormat()	291
10.65.4.9 GetInterfile()	291

---

10.65.4.10 GetMrProtocol()	291
10.65.4.11 LoadFromDataElement()	291
10.65.4.12 Print()	292
10.65.5 Friends And Related Function Documentation	292
10.65.5.1 operator<<	292
10.66 gdcM::CSAHeaderDict Class Reference	292
10.66.1 Detailed Description	293
10.66.2 Member Typedef Documentation	293
10.66.2.1 ConstIterator	293
10.66.2.2 Iterator	293
10.66.2.3 MapCSAHeaderDictEntry	293
10.66.3 Constructor & Destructor Documentation	293
10.66.3.1 CSAHeaderDict() [1/2]	294
10.66.3.2 CSAHeaderDict() [2/2]	294
10.66.4 Member Function Documentation	294
10.66.4.1 AddCSAHeaderDictEntry()	294
10.66.4.2 Begin()	294
10.66.4.3 End()	294
10.66.4.4 GetCSAHeaderDictEntry()	294
10.66.4.5 IsEmpty()	295
10.66.4.6 LoadDefault()	295
10.66.4.7 operator=()	295
10.66.5 Friends And Related Function Documentation	295
10.66.5.1 Dicts	295
10.66.5.2 operator<<	295
10.67 gdcM::CSAHeaderDictEntry Class Reference	295
10.67.1 Detailed Description	296
10.67.2 Constructor & Destructor Documentation	296
10.67.2.1 CSAHeaderDictEntry()	297
10.67.3 Member Function Documentation	297
10.67.3.1 GetDescription()	297
10.67.3.2 GetName()	297
10.67.3.3 GetVM()	297
10.67.3.4 GetVR()	297
10.67.3.5 operator<()	298
10.67.3.6 SetDescription()	298
10.67.3.7 SetName()	298
10.67.3.8 SetVM()	298
10.67.3.9 SetVR()	298



---

10.67.4 Friends And Related Function Documentation	298
10.67.4.1 operator<<	299
10.68 gdcm::CSAHeaderDictException Class Reference	299
10.69 gdcm::network::CStoreRQ Class Reference	300
10.69.1 Detailed Description	300
10.69.2 Member Function Documentation	301
10.69.2.1 ConstructPDV()	301
10.70 gdcm::network::CStoreRSP Class Reference	301
10.70.1 Detailed Description	302
10.70.2 Member Function Documentation	302
10.70.2.1 ConstructPDV()	302
10.71 gdcm::Curve Class Reference	303
10.71.1 Detailed Description	304
10.71.2 Constructor & Destructor Documentation	304
10.71.2.1 Curve() [1/2]	305
10.71.2.2 ~Curve()	305
10.71.2.3 Curve() [2/2]	305
10.71.3 Member Function Documentation	305
10.71.3.1 Decode()	305
10.71.3.2 GetAsPoints()	305
10.71.3.3 GetCurveDataDescriptor()	305
10.71.3.4 GetDataValueRepresentation()	306
10.71.3.5 GetDimensions()	306
10.71.3.6 GetGroup()	306
10.71.3.7 GetNumberOfCurves()	306
10.71.3.8 GetNumberOfPoints()	306
10.71.3.9 GetTypeInfoData()	306
10.71.3.10 GetTypeInfoDataDescription()	306
10.71.3.11 IsEmpty()	307
10.71.3.12 Print()	307
10.71.3.13 SetCoordinateStartValue()	307
10.71.3.14 SetCoordinateStepValue()	307
10.71.3.15 SetCurve()	307
10.71.3.16 SetCurveDataDescriptor()	307
10.71.3.17 SetCurveDescription()	308
10.71.3.18 SetDataValueRepresentation()	308
10.71.3.19 SetDimensions()	308
10.71.3.20 SetGroup()	308
10.71.3.21 SetNumberOfPoints()	308

---

10.71.3.22 SetTypeOfData()	308
10.71.3.23 Update()	309
10.72 gdcM::DataElement Class Reference	309
10.72.1 Detailed Description	312
10.72.2 Member Typedef Documentation	312
10.72.2.1 ValuePtr	312
10.72.3 Constructor & Destructor Documentation	312
10.72.3.1 DataElement() [1/2]	313
10.72.3.2 DataElement() [2/2]	313
10.72.4 Member Function Documentation	313
10.72.4.1 Clear()	313
10.72.4.2 Empty()	313
10.72.4.3 GetByteValue()	313
10.72.4.4 GetLength()	314
10.72.4.5 GetSequenceOfFragments() [1/2]	314
10.72.4.6 GetSequenceOfFragments() [2/2]	314
10.72.4.7 GetTag() [1/2]	314
10.72.4.8 GetTag() [2/2]	314
10.72.4.9 GetValue() [1/2]	315
10.72.4.10 GetValue() [2/2]	315
10.72.4.11 GetValueAsSQ()	315
10.72.4.12 GetVL() [1/2]	316
10.72.4.13 GetVL() [2/2]	316
10.72.4.14 GetVR()	316
10.72.4.15 IsEmpty()	316
10.72.4.16 IsUndefinedLength()	317
10.72.4.17 operator<()	317
10.72.4.18 operator=()	317
10.72.4.19 operator==(())	317
10.72.4.20 Read()	317
10.72.4.21 ReadOrSkip()	318
10.72.4.22 ReadPreValue()	318
10.72.4.23 ReadValue()	318
10.72.4.24 ReadValueWithLength()	318
10.72.4.25 ReadWithLength()	318
10.72.4.26 SetByteValue()	319
10.72.4.27 SetTag()	319
10.72.4.28 SetValue()	320
10.72.4.29 SetValueFieldLength()	320

---

10.72.4.30 SetVL()	320
10.72.4.31 SetVLToUndefined()	320
10.72.4.32 SetVR()	321
10.72.4.33 Write()	321
10.72.5 Friends And Related Function Documentation	321
10.72.5.1 operator<<	321
10.72.6 Member Data Documentation	321
10.72.6.1 TagField	322
10.72.6.2 ValueField	322
10.72.6.3 ValueLengthField	322
10.72.6.4 VRField	322
10.73 gdcM::DataElementException Class Reference	323
10.74 gdcM::DataEvent Class Reference	323
10.74.1 Detailed Description	325
10.74.2 Member Typedef Documentation	325
10.74.2.1 Self	325
10.74.2.2 Superclass	325
10.74.3 Constructor & Destructor Documentation	325
10.74.3.1 DataEvent() [1/2]	325
10.74.3.2 ~DataEvent()	326
10.74.3.3 DataEvent() [2/2]	326
10.74.4 Member Function Documentation	326
10.74.4.1 CheckEvent()	326
10.74.4.2 GetData()	326
10.74.4.3 GetDataLength()	326
10.74.4.4 GetEventName()	326
10.74.4.5 MakeObject()	327
10.74.4.6 operator=()	327
10.74.4.7 SetData()	327
10.75 gdcM::DataSet Class Reference	327
10.75.1 Detailed Description	329
10.75.2 Member Typedef Documentation	330
10.75.2.1 ConstIterator	330
10.75.2.2 DataElementSet	330
10.75.2.3 Iterator	330
10.75.2.4 SizeType	330
10.75.3 Member Function Documentation	331
10.75.3.1 Begin() [1/2]	331
10.75.3.2 Begin() [2/2]	331

---

10.75.3.3 Clear()	331
10.75.3.4 ComputeDataElement()	331
10.75.3.5 ComputeGroupLength()	331
10.75.3.6 End() [1/2]	332
10.75.3.7 End() [2/2]	332
10.75.3.8 FindDataElement() [1/2]	332
10.75.3.9 FindDataElement() [2/2]	332
10.75.3.10 FindNextDataElement()	333
10.75.3.11 GetDataElement() [1/2]	333
10.75.3.12 GetDataElement() [2/2]	333
10.75.3.13 GetDEEnd()	334
10.75.3.14 GetDES() [1/2]	334
10.75.3.15 GetDES() [2/2]	334
10.75.3.16 GetLength()	334
10.75.3.17 GetMediaStorage()	334
10.75.3.18 GetPrivateCreator()	334
10.75.3.19 Insert()	335
10.75.3.20 InsertDataElement()	335
10.75.3.21 IsEmpty()	335
10.75.3.22 operator()	335
10.75.3.23 operator=()	336
10.75.3.24 operator[]()	336
10.75.3.25 Print()	336
10.75.3.26 Read()	336
10.75.3.27 ReadNested()	336
10.75.3.28 ReadSelectedPrivateTags()	337
10.75.3.29 ReadSelectedPrivateTagsWithLength()	337
10.75.3.30 ReadSelectedTags()	337
10.75.3.31 ReadSelectedTagsWithLength()	337
10.75.3.32 ReadUpToTag()	337
10.75.3.33 ReadUpToTagWithLength()	338
10.75.3.34 ReadWithLength()	338
10.75.3.35 Remove()	338
10.75.3.36 Replace()	338
10.75.3.37 ReplaceEmpty()	339
10.75.3.38 Size()	339
10.75.3.39 Write()	339
10.75.4 Friends And Related Function Documentation	339
10.75.4.1 CSAHeader	339

---

10.75.4.2 operator<<	340
10.76 gdcM::DataSetEvent Class Reference	340
10.76.1 Detailed Description	341
10.76.2 Member Typedef Documentation	342
10.76.2.1 Self	342
10.76.2.2 Superclass	342
10.76.3 Constructor & Destructor Documentation	342
10.76.3.1 DataSetEvent() [1/2]	342
10.76.3.2 ~DataSetEvent()	342
10.76.3.3 DataSetEvent() [2/2]	342
10.76.4 Member Function Documentation	342
10.76.4.1 CheckEvent()	343
10.76.4.2 GetDataSet()	343
10.76.4.3 GetEventName()	343
10.76.4.4 MakeObject()	343
10.76.4.5 operator=()	343
10.76.5 Member Data Documentation	343
10.76.5.1 m_DataSet	344
10.77 gdcM::DataSetHelper Class Reference	344
10.77.1 Detailed Description	344
10.77.2 Member Function Documentation	344
10.77.2.1 ComputeVR()	344
10.78 gdcM::Decoder Class Reference	345
10.78.1 Detailed Description	345
10.78.2 Constructor & Destructor Documentation	345
10.78.2.1 ~Decoder()	346
10.78.3 Member Function Documentation	346
10.78.3.1 CanDecode()	346
10.78.3.2 Decode()	346
10.78.3.3 DecodeByStreams()	346
10.79 gdcM::DefinedTerms Class Reference	347
10.79.1 Detailed Description	347
10.79.2 Constructor & Destructor Documentation	347
10.79.2.1 DefinedTerms()	347
10.80 gdcM::Defs Class Reference	347
10.80.1 Detailed Description	348
10.80.2 Constructor & Destructor Documentation	348
10.80.2.1 Defs() [1/2]	349
10.80.2.2 ~Defs()	349

---

10.80.2.3 Defs() [2/2] . . . . .	349
10.80.3 Member Function Documentation . . . . .	349
10.80.3.1 GetIODFromFile() . . . . .	349
10.80.3.2 GetIODNameFromMediaStorage() . . . . .	349
10.80.3.3 GetIODs() [1/2] . . . . .	349
10.80.3.4 GetIODs() [2/2] . . . . .	350
10.80.3.5 GetMacros() [1/2] . . . . .	350
10.80.3.6 GetMacros() [2/2] . . . . .	350
10.80.3.7 GetModules() [1/2] . . . . .	350
10.80.3.8 GetModules() [2/2] . . . . .	350
10.80.3.9 GetTypeFromTag() . . . . .	350
10.80.3.10 IsEmpty() . . . . .	350
10.80.3.11 LoadDefaults() . . . . .	351
10.80.3.12 LoadFromFile() . . . . .	351
10.80.3.13 operator=() . . . . .	351
10.80.3.14 Verify() [1/2] . . . . .	351
10.80.3.15 Verify() [2/2] . . . . .	351
10.80.4 Friends And Related Function Documentation . . . . .	351
10.80.4.1 Global . . . . .	351
10.81 gdcm::DeltaEncodingCodec Class Reference . . . . .	352
10.81.1 Detailed Description . . . . .	353
10.81.2 Constructor & Destructor Documentation . . . . .	353
10.81.2.1 DeltaEncodingCodec() . . . . .	353
10.81.2.2 ~DeltaEncodingCodec() . . . . .	353
10.81.3 Member Function Documentation . . . . .	353
10.81.3.1 CanDecode() . . . . .	353
10.81.3.2 Decode() [1/2] . . . . .	353
10.81.3.3 Decode() [2/2] . . . . .	354
10.82 gdcm::DICOMDIR Class Reference . . . . .	354
10.82.1 Detailed Description . . . . .	354
10.82.2 Constructor & Destructor Documentation . . . . .	354
10.82.2.1 DICOMDIR() [1/2] . . . . .	354
10.82.2.2 DICOMDIR() [2/2] . . . . .	354
10.83 gdcm::DICOMDIRGenerator Class Reference . . . . .	355
10.83.1 Detailed Description . . . . .	355
10.83.2 Member Typedef Documentation . . . . .	356
10.83.2.1 FilenamesType . . . . .	356
10.83.2.2 FilenameType . . . . .	356
10.83.3 Constructor & Destructor Documentation . . . . .	356

---

10.83.3.1 DICOMDIRGenerator()	356
10.83.3.2 ~DICOMDIRGenerator()	357
10.83.4 Member Function Documentation	357
10.83.4.1 AddImageDirectoryRecord()	357
10.83.4.2 AddPatientDirectoryRecord()	357
10.83.4.3 AddSeriesDirectoryRecord()	357
10.83.4.4 AddStudyDirectoryRecord()	357
10.83.4.5 Generate()	357
10.83.4.6 GetFile()	358
10.83.4.7 GetScanner()	358
10.83.4.8 SetDescriptor()	358
10.83.4.9 SetFile()	358
10.83.4.10 SetFilenames()	358
10.83.4.11 SetRootDirectory()	359
10.84 gdcmm::Dict Class Reference	359
10.84.1 Detailed Description	360
10.84.2 Member Typedef Documentation	360
10.84.2.1 ConstIterator	360
10.84.2.2 Iterator	360
10.84.2.3 MapDictEntry	360
10.84.3 Constructor & Destructor Documentation	360
10.84.3.1 Dict() [1/2]	361
10.84.3.2 Dict() [2/2]	361
10.84.4 Member Function Documentation	361
10.84.4.1 AddDictEntry()	361
10.84.4.2 Begin()	361
10.84.4.3 End()	361
10.84.4.4 GetDictEntry()	362
10.84.4.5 GetDictEntryByKeyword()	362
10.84.4.6 GetDictEntryByName()	362
10.84.4.7 GetKeywordFromTag()	362
10.84.4.8 IsEmpty()	363
10.84.4.9 LoadDefault()	363
10.84.4.10 operator=()	363
10.84.5 Friends And Related Function Documentation	363
10.84.5.1 Dicts	363
10.84.5.2 operator<<	363
10.85 gdcmm::DictConverter Class Reference	363
10.85.1 Detailed Description	364

---

10.85.2 Member Enumeration Documentation	365
10.85.2.1 OutputTypes	365
10.85.3 Constructor & Destructor Documentation	365
10.85.3.1 DictConverter()	365
10.85.3.2 ~DictConverter()	365
10.85.4 Member Function Documentation	365
10.85.4.1 AddGroupLength()	365
10.85.4.2 Convert()	366
10.85.4.3 ConvertToCXX()	366
10.85.4.4 ConvertToXML()	366
10.85.4.5 GetDictName()	366
10.85.4.6 GetInputFilename()	366
10.85.4.7 GetOutputFilename()	366
10.85.4.8 GetOutputType()	366
10.85.4.9 Readuint16()	367
10.85.4.10 ReadVM()	367
10.85.4.11 ReadVR()	367
10.85.4.12 SetDictName()	367
10.85.4.13 SetInputFileName()	367
10.85.4.14 SetOutputFileName()	367
10.85.4.15 SetOutputType()	368
10.85.4.16 WriteFooter()	368
10.85.4.17 WriteHeader()	368
10.86 gdcM::DictEntry Class Reference	368
10.86.1 Detailed Description	369
10.86.2 Constructor & Destructor Documentation	369
10.86.2.1 DictEntry()	369
10.86.3 Member Function Documentation	369
10.86.3.1 GetKeyword()	370
10.86.3.2 GetName()	370
10.86.3.3 GetRetired()	370
10.86.3.4 GetVM()	370
10.86.3.5 GetVR()	371
10.86.3.6 IsUnique()	371
10.86.3.7 SetElementXX()	371
10.86.3.8 SetGroupXX()	371
10.86.3.9 SetKeyword()	371
10.86.3.10 SetName()	372
10.86.3.11 SetRetired()	372



---

10.86.3.12 SetVM()	372
10.86.3.13 SetVR()	372
10.86.4 Friends And Related Function Documentation	372
10.86.4.1 Dict	372
10.86.4.2 operator<<	373
10.87 gdcM::DictPrinter Class Reference	373
10.87.1 Detailed Description	374
10.87.2 Constructor & Destructor Documentation	374
10.87.2.1 DictPrinter()	375
10.87.2.2 ~DictPrinter()	375
10.87.3 Member Function Documentation	375
10.87.3.1 Print()	375
10.87.3.2 PrintDataElement2()	375
10.87.3.3 PrintDataSet2()	375
10.88 gdcM::Dicts Class Reference	376
10.88.1 Detailed Description	377
10.88.2 Member Enumeration Documentation	377
10.88.2.1 ConstructorType	377
10.88.3 Constructor & Destructor Documentation	377
10.88.3.1 Dicts() [1/2]	377
10.88.3.2 ~Dicts()	377
10.88.3.3 Dicts() [2/2]	378
10.88.4 Member Function Documentation	378
10.88.4.1 GetConstructorString()	378
10.88.4.2 GetCSAHeaderDict()	378
10.88.4.3 GetDictEntry() [1/2]	378
10.88.4.4 GetDictEntry() [2/2]	378
10.88.4.5 GetPrivateDict() [1/2]	379
10.88.4.6 GetPrivateDict() [2/2]	379
10.88.4.7 GetPublicDict()	379
10.88.4.8 IsEmpty()	379
10.88.4.9 LoadDefaults()	379
10.88.4.10 operator=()	379
10.88.5 Friends And Related Function Documentation	379
10.88.5.1 Global	380
10.88.5.2 operator<<	380
10.89 gdcM::network::DIMSE Class Reference	380
10.89.1 Detailed Description	381
10.89.2 Member Enumeration Documentation	381

---

10.89.2.1 CommandTypes	381
10.90 gdcM::DirectionCosines Class Reference	382
10.90.1 Detailed Description	382
10.90.2 Constructor & Destructor Documentation	383
10.90.2.1 DirectionCosines() [1/2]	383
10.90.2.2 DirectionCosines() [2/2]	383
10.90.2.3 ~DirectionCosines()	383
10.90.3 Member Function Documentation	383
10.90.3.1 ComputeDistAlongNormal()	383
10.90.3.2 Cross()	383
10.90.3.3 CrossDot()	384
10.90.3.4 Dot() [1/2]	384
10.90.3.5 Dot() [2/2]	384
10.90.3.6 IsValid()	384
10.90.3.7 Normalize() [1/2]	384
10.90.3.8 Normalize() [2/2]	385
10.90.3.9 operator const double *()	385
10.90.3.10 Print()	385
10.90.3.11 SetFromString()	385
10.91 gdcM::Directory Class Reference	385
10.91.1 Detailed Description	386
10.91.2 Member Typedef Documentation	387
10.91.2.1 FilenamesType	387
10.91.2.2 FilenameType	387
10.91.3 Constructor & Destructor Documentation	387
10.91.3.1 Directory()	387
10.91.3.2 ~Directory()	387
10.91.4 Member Function Documentation	387
10.91.4.1 Explore()	388
10.91.4.2 GetDirectories()	388
10.91.4.3 GetFilenames()	388
10.91.4.4 GetToplevel()	388
10.91.4.5 Load()	389
10.91.4.6 Print()	389
10.91.5 Friends And Related Function Documentation	389
10.91.5.1 operator<<	389
10.92 gdcM::DirectoryHelper Class Reference	390
10.92.1 Detailed Description	390
10.92.2 Member Function Documentation	390

---

10.92.2.1	GetCTImageSeriesUIDs()	390
10.92.2.2	GetFileNamesFromSeriesUIDs()	391
10.92.2.3	GetFrameOfReference()	391
10.92.2.4	GetMRIImageSeriesUIDs()	391
10.92.2.5	GetRTStructSeriesUIDs()	391
10.92.2.6	GetSeriesUIDsBySOPClassUID()	391
10.92.2.7	GetSOPClassUID()	392
10.92.2.8	GetStringValueFromTag()	392
10.92.2.9	LoadImageFromFiles()	392
10.92.2.10	RetrieveSOPInstanceUIDFromIndex()	392
10.92.2.11	RetrieveSOPInstanceUIDFromZPosition()	392
10.93	gdcm::DummyValueGenerator Class Reference	392
10.93.1	Detailed Description	393
10.93.2	Member Function Documentation	393
10.93.2.1	Generate()	393
10.94	gdcm::Dumper Class Reference	393
10.94.1	Detailed Description	394
10.94.2	Constructor & Destructor Documentation	394
10.94.2.1	Dumper()	395
10.94.2.2	~Dumper()	395
10.95	gdcm::Element< TVR, TVM > Class Template Reference	395
10.95.1	Detailed Description	397
10.95.2	Member Typedef Documentation	397
10.95.2.1	Type	397
10.95.3	Member Function Documentation	397
10.95.3.1	GetAsDataElement()	397
10.95.3.2	GetLength()	398
10.95.3.3	GetValue() [1/2]	398
10.95.3.4	GetValue() [2/2]	398
10.95.3.5	GetValues()	398
10.95.3.6	GetVM()	398
10.95.3.7	GetVR()	399
10.95.3.8	operator[]()	399
10.95.3.9	Print()	399
10.95.3.10	Read()	399
10.95.3.11	Set()	399
10.95.3.12	SetFromDataElement()	400
10.95.3.13	SetNoSwap()	400
10.95.3.14	SetValue()	400

---

10.95.3.15 Write()	400
10.95.4 Member Data Documentation	400
10.95.4.1 Internal	401
10.96 gdcM::Element< TVR, VM::VM1_2 > Class Template Reference	401
10.96.1 Member Typedef Documentation	402
10.96.1.1 Parent	402
10.96.2 Member Function Documentation	402
10.96.2.1 SetLength()	402
10.97 gdcM::Element< TVR, VM::VM1_n > Class Template Reference	403
10.97.1 Member Typedef Documentation	404
10.97.1.1 Type	404
10.97.2 Constructor & Destructor Documentation	404
10.97.2.1 Element() [1/2]	404
10.97.2.2 ~Element()	404
10.97.2.3 Element() [2/2]	404
10.97.3 Member Function Documentation	405
10.97.3.1 GetAsDataElement()	405
10.97.3.2 GetLength()	405
10.97.3.3 GetValue() [1/2]	405
10.97.3.4 GetValue() [2/2]	405
10.97.3.5 GetVM()	405
10.97.3.6 GetVR()	406
10.97.3.7 operator=()	406
10.97.3.8 operator[]()	406
10.97.3.9 Print()	406
10.97.3.10 Read()	406
10.97.3.11 Set()	406
10.97.3.12 SetArray()	407
10.97.3.13 SetFromDataElement()	407
10.97.3.14 SetLength()	407
10.97.3.15 SetNoSwap()	407
10.97.3.16 SetValue()	407
10.97.3.17 Write()	408
10.97.3.18 WriteASCII()	408
10.98 gdcM::Element< TVR, VM::VM2_2n > Class Template Reference	408
10.98.1 Member Typedef Documentation	409
10.98.1.1 Parent	409
10.98.2 Member Function Documentation	409
10.98.2.1 SetLength()	410

---

10.99 gdcM::Element< TVR, VM::VM2_n > Class Template Reference	410
10.99.1 Member Typedef Documentation	411
10.99.1.1 Parent	411
10.99.2 Member Function Documentation	411
10.99.2.1 SetLength()	412
10.100 gdcM::Element< TVR, VM::VM3_3n > Class Template Reference	412
10.100.1 Member Typedef Documentation	413
10.100.1.1 Parent	413
10.100.2 Member Function Documentation	413
10.100.2.1 SetLength()	414
10.101 gdcM::Element< TVR, VM::VM3_4 > Class Template Reference	414
10.101.1 Member Typedef Documentation	415
10.101.1.1 Parent	415
10.101.2 Member Function Documentation	415
10.101.2.1 SetLength()	415
10.102 gdcM::Element< TVR, VM::VM3_n > Class Template Reference	416
10.102.1 Member Typedef Documentation	417
10.102.1.1 Parent	417
10.102.2 Member Function Documentation	417
10.102.2.1 SetLength()	417
10.103 gdcM::Element< VR::AS, VM::VM5 > Class Reference	417
10.103.1 Member Function Documentation	418
10.103.1.1 GetLength()	418
10.103.1.2 Print()	418
10.103.2 Member Data Documentation	418
10.103.2.1 Internal	418
10.104 gdcM::Element< VR::OB, VM::VM1 > Class Reference	418
10.105 gdcM::Element< VR::OW, VM::VM1 > Class Reference	420
10.106 gdcM::ElementDisableCombinations< TVR, TVM > Class Template Reference	422
10.106.1 Detailed Description	423
10.107 gdcM::ElementDisableCombinations< VR::OB, VM::VM1_n > Class Reference	423
10.108 gdcM::ElementDisableCombinations< VR::OW, VM::VM1_n > Class Reference	423
10.109 gdcM::EmptyMaskGenerator Class Reference	423
10.109.1 Detailed Description	424
10.109.2 Member Enumeration Documentation	425
10.109.2.1 SOPClassUIDMode	425
10.109.3 Constructor & Destructor Documentation	425
10.109.3.1 EmptyMaskGenerator()	425
10.109.3.2 ~EmptyMaskGenerator()	425

---

10.109.4 Member Function Documentation	425
10.109.4.1 Execute()	425
10.109.4.2 SetInputDirectory()	426
10.109.4.3 SetOutputDirectory()	426
10.109.4.4 SetSOPClassUIDMode()	426
10.110 gdcM::EncapsulatedDocument Class Reference	426
10.110.1 Detailed Description	427
10.110.2 Constructor & Destructor Documentation	427
10.110.2.1 EncapsulatedDocument()	427
10.111 gdcM::EncodingImplementation< T > Class Template Reference	427
10.111.1 Detailed Description	427
10.112 gdcM::EncodingImplementation< VR::VRASCII > Class Reference	428
10.112.1 Member Function Documentation	428
10.112.1.1 Read()	428
10.112.1.2 ReadComputeLength()	428
10.112.1.3 ReadNoSwap()	429
10.112.1.4 Write() [1/2]	429
10.112.1.5 Write() [2/2]	429
10.113 gdcM::EncodingImplementation< VR::VRBINARY > Class Reference	429
10.113.1 Member Function Documentation	430
10.113.1.1 Read()	430
10.113.1.2 ReadComputeLength()	430
10.113.1.3 ReadNoSwap()	430
10.113.1.4 Write()	430
10.114 gdcM::EndEvent Class Reference	431
10.115 gdcM::EnumeratedValues Class Reference	432
10.115.1 Detailed Description	432
10.115.2 Constructor & Destructor Documentation	432
10.115.2.1 EnumeratedValues()	432
10.116 gdcM::EquipmentManufacturer Class Reference	432
10.116.1 Detailed Description	433
10.116.2 Member Enumeration Documentation	433
10.116.2.1 Type	433
10.116.3 Member Function Documentation	434
10.116.3.1 Compute()	434
10.117 gdcM::Event Class Reference	434
10.117.1 Detailed Description	436
10.117.2 Constructor & Destructor Documentation	436
10.117.2.1 Event() [1/2]	436

---

10.117.2.2	~Event()	436
10.117.2.3	Event() [2/2]	436
10.117.3	Member Function Documentation	436
10.117.3.1	CheckEvent()	436
10.117.3.2	GetEventName()	437
10.117.3.3	MakeObject()	437
10.117.3.4	operator=()	437
10.117.3.5	Print()	437
10.118	gdcM::Exception Class Reference	438
10.118.1	Detailed Description	439
10.118.2	Constructor & Destructor Documentation	439
10.118.2.1	Exception()	439
10.118.2.2	~Exception()	439
10.118.3	Member Function Documentation	439
10.118.3.1	GetDescription()	439
10.118.3.2	what()	440
10.119	gdcM::ExitEvent Class Reference	440
10.120	gdcM::ExplicitDataElement Class Reference	441
10.120.1	Detailed Description	442
10.120.2	Member Function Documentation	443
10.120.2.1	GetLength()	443
10.120.2.2	Read()	443
10.120.2.3	ReadPreValue()	443
10.120.2.4	ReadValue()	443
10.120.2.5	ReadWithLength()	443
10.120.2.6	Write()	444
10.121	gdcM::ExplicitImplicitDataElement Class Reference	444
10.121.1	Detailed Description	445
10.121.2	Member Function Documentation	446
10.121.2.1	GetLength()	446
10.121.2.2	Read()	446
10.121.2.3	ReadPreValue()	446
10.121.2.4	ReadValue()	446
10.121.2.5	ReadWithLength()	446
10.122	gdcM::Fiducials Class Reference	447
10.122.1	Detailed Description	447
10.122.2	Constructor & Destructor Documentation	447
10.122.2.1	Fiducials()	447
10.123	gdcM::File Class Reference	447

---

10.123.1 Detailed Description	449
10.123.2 Constructor & Destructor Documentation	449
10.123.2.1 File()	449
10.123.2.2 ~File()	450
10.123.3 Member Function Documentation	450
10.123.3.1 GetDataSet() [1/2]	450
10.123.3.2 GetDataSet() [2/2]	450
10.123.3.3 GetHeader() [1/2]	450
10.123.3.4 GetHeader() [2/2]	451
10.123.3.5 Read()	451
10.123.3.6 SetDataSet()	451
10.123.3.7 SetHeader()	451
10.123.3.8 Write()	452
10.123.4 Friends And Related Function Documentation	452
10.123.4.1 operator<<	452
10.124 gdcM::FileAnonymizer Class Reference	452
10.124.1 Detailed Description	453
10.124.2 Constructor & Destructor Documentation	454
10.124.2.1 FileAnonymizer()	454
10.124.2.2 ~FileAnonymizer()	454
10.124.3 Member Function Documentation	454
10.124.3.1 Empty()	454
10.124.3.2 Remove()	455
10.124.3.3 Replace() [1/2]	455
10.124.3.4 Replace() [2/2]	455
10.124.3.5 SetInputFileName()	455
10.124.3.6 SetOutputFileName()	456
10.124.3.7 Write()	456
10.125 gdcM::FileChangeTransferSyntax Class Reference	456
10.125.1 Detailed Description	457
10.125.2 Constructor & Destructor Documentation	458
10.125.2.1 FileChangeTransferSyntax()	458
10.125.2.2 ~FileChangeTransferSyntax()	458
10.125.3 Member Function Documentation	458
10.125.3.1 Change()	458
10.125.3.2 GetCodec()	458
10.125.3.3 New()	459
10.125.3.4 SetInputFileName()	459
10.125.3.5 SetOutputFileName()	459



---

10.125.3.6 SetTransferSyntax() . . . . .	459
10.126 gdcmm::FileDecompressLookupTable Class Reference . . . . .	460
10.126.1 Detailed Description . . . . .	461
10.126.2 Constructor & Destructor Documentation . . . . .	461
10.126.2.1 FileDecompressLookupTable() . . . . .	461
10.126.2.2 ~FileDecompressLookupTable() . . . . .	461
10.126.3 Member Function Documentation . . . . .	461
10.126.3.1 Change() . . . . .	462
10.126.3.2 GetFile() . . . . .	462
10.126.3.3 GetPixmap() [1/2] . . . . .	462
10.126.3.4 GetPixmap() [2/2] . . . . .	462
10.126.3.5 SetFile() . . . . .	462
10.126.3.6 SetPixmap() . . . . .	462
10.127 gdcmm::FileDerivation Class Reference . . . . .	463
10.127.1 Detailed Description . . . . .	463
10.127.2 Constructor & Destructor Documentation . . . . .	464
10.127.2.1 FileDerivation() . . . . .	464
10.127.2.2 ~FileDerivation() . . . . .	464
10.127.3 Member Function Documentation . . . . .	464
10.127.3.1 AddDerivationDescription() . . . . .	464
10.127.3.2 AddPurposeOfReferenceCodeSequence() . . . . .	464
10.127.3.3 AddReference() . . . . .	464
10.127.3.4 AddSourceImageSequence() . . . . .	465
10.127.3.5 Derive() . . . . .	465
10.127.3.6 GetFile() [1/2] . . . . .	465
10.127.3.7 GetFile() [2/2] . . . . .	465
10.127.3.8 SetAppendDerivationHistory() . . . . .	465
10.127.3.9 SetDerivationCodeSequenceCodeValue() . . . . .	466
10.127.3.10 SetDerivationDescription() . . . . .	466
10.127.3.11 SetFile() . . . . .	466
10.127.3.12 SetPurposeOfReferenceCodeSequenceCodeValue() . . . . .	466
10.128 gdcmm::FileExplicitFilter Class Reference . . . . .	467
10.128.1 Detailed Description . . . . .	467
10.128.2 Constructor & Destructor Documentation . . . . .	468
10.128.2.1 FileExplicitFilter() . . . . .	468
10.128.2.2 ~FileExplicitFilter() . . . . .	468
10.128.3 Member Function Documentation . . . . .	468
10.128.3.1 Change() . . . . .	468
10.128.3.2 ChangeFMI() . . . . .	468

---

10.128.3.3	GetFile()	468
10.128.3.4	ProcessDataSet()	469
10.128.3.5	SetChangePrivateTags()	469
10.128.3.6	SetFile()	469
10.128.3.7	SetRecomputeItemLength()	469
10.128.3.8	SetRecomputeSequenceLength()	469
10.128.3.9	SetUseVRUN()	470
10.129	gdcm::FileMetaInformation Class Reference	470
10.129.1	Detailed Description	472
10.129.2	Constructor & Destructor Documentation	472
10.129.2.1	FileMetaInformation() [1/2]	473
10.129.2.2	~FileMetaInformation()	473
10.129.2.3	FileMetaInformation() [2/2]	473
10.129.3	Member Function Documentation	473
10.129.3.1	AppendImplementationClassUID()	473
10.129.3.2	ComputeDataSetMediaStorageSOPClass()	473
10.129.3.3	ComputeDataSetTransferSyntax()	473
10.129.3.4	Default()	474
10.129.3.5	FillFromDataSet()	474
10.129.3.6	GetDataSetTransferSyntax()	474
10.129.3.7	GetFileMetaInformationVersion()	474
10.129.3.8	GetFullLength()	474
10.129.3.9	GetGDCMImplementationClassUID()	474
10.129.3.10	GetGDCMImplementationVersionName()	475
10.129.3.11	GetGDCMSourceApplicationEntityTitle()	475
10.129.3.12	GetImplementationClassUID()	475
10.129.3.13	GetImplementationVersionName()	475
10.129.3.14	GetMediaStorage()	475
10.129.3.15	GetMediaStorageAsString()	475
10.129.3.16	GetMetaInformationTS()	475
10.129.3.17	GetPreamble() [1/2]	476
10.129.3.18	GetPreamble() [2/2]	476
10.129.3.19	GetSourceApplicationEntityTitle()	476
10.129.3.20	Insert()	476
10.129.3.21	IsValid()	476
10.129.3.22	operator=()	476
10.129.3.23	Read()	477
10.129.3.24	ReadCompat()	477
10.129.3.25	ReadCompatInternal()	477

---

10.129.3.26 Replace()	477
10.129.3.27 SetDataSetTransferSyntax()	477
10.129.3.28 SetImplementationClassUID()	478
10.129.3.29 SetImplementationVersionName()	478
10.129.3.30 SetPreamble()	478
10.129.3.31 SetSourceApplicationEntityTitle()	478
10.129.3.32 Write()	478
10.129.4 Friends And Related Function Documentation	478
10.129.4.1 operator<<	479
10.129.5 Member Data Documentation	479
10.129.5.1 DataSetMS	479
10.129.5.2 DataSetTS	479
10.129.5.3 MetalInformationTS	479
10.130 gdcm::Filename Class Reference	479
10.130.1 Detailed Description	480
10.130.2 Constructor & Destructor Documentation	480
10.130.2.1 Filename()	480
10.130.3 Member Function Documentation	481
10.130.3.1 EndWith()	481
10.130.3.2 GetExtension()	481
10.130.3.3 GetFileName()	481
10.130.3.4 GetName()	481
10.130.3.5 GetPath()	481
10.130.3.6 IsEmpty()	482
10.130.3.7 IsIdentical()	482
10.130.3.8 Join()	482
10.130.3.9 operator const char *()	482
10.130.3.10 ToUnixSlashes()	482
10.130.3.11 ToWindowsSlashes()	483
10.131 gdcm::FileNameEvent Class Reference	483
10.131.1 Detailed Description	484
10.131.2 Member Typedef Documentation	485
10.131.2.1 Self	485
10.131.2.2 Superclass	485
10.131.3 Constructor & Destructor Documentation	485
10.131.3.1 FileNameEvent() [1/2]	485
10.131.3.2 ~FileNameEvent()	485
10.131.3.3 FileNameEvent() [2/2]	485
10.131.4 Member Function Documentation	485

---

10.131.4.1 CheckEvent()	486
10.131.4.2 GetEventName()	486
10.131.4.3 GetFileName()	486
10.131.4.4 MakeObject()	486
10.131.4.5 operator=()	486
10.131.4.6 SetFileName()	487
10.132 gdcM::FilenameGenerator Class Reference	487
10.132.1 Detailed Description	488
10.132.2 Member Typedef Documentation	488
10.132.2.1 FilenamesType	488
10.132.2.2 FilenameType	488
10.132.2.3 SizeType	488
10.132.3 Constructor & Destructor Documentation	488
10.132.3.1 FilenameGenerator()	489
10.132.3.2 ~FilenameGenerator()	489
10.132.4 Member Function Documentation	489
10.132.4.1 Generate()	489
10.132.4.2 GetFilename()	489
10.132.4.3 GetFilenames()	489
10.132.4.4 GetNumberOfFilenames()	490
10.132.4.5 GetPattern()	490
10.132.4.6 GetPrefix()	490
10.132.4.7 SetNumberOfFilenames()	490
10.132.4.8 SetPattern()	490
10.132.4.9 SetPrefix()	491
10.133 gdcM::FileSet Class Reference	491
10.133.1 Detailed Description	491
10.133.2 Member Typedef Documentation	491
10.133.2.1 FileType	492
10.133.2.2 FileType	492
10.133.3 Constructor & Destructor Documentation	492
10.133.3.1 FileSet()	492
10.133.4 Member Function Documentation	492
10.133.4.1 AddFile() [1/2]	492
10.133.4.2 AddFile() [2/2]	492
10.133.4.3 GetFiles()	493
10.133.4.4 SetFiles()	493
10.133.5 Friends And Related Function Documentation	493
10.133.5.1 operator<<	493

---

10.134 gdcM::FileStreamer Class Reference . . . . .	493
10.134.1 Detailed Description . . . . .	495
10.134.2 Constructor & Destructor Documentation . . . . .	495
10.134.2.1 FileStreamer() . . . . .	495
10.134.2.2 ~FileStreamer() . . . . .	495
10.134.3 Member Function Documentation . . . . .	495
10.134.3.1 AppendToDataElement() . . . . .	495
10.134.3.2 AppendToGroupDataElement() . . . . .	496
10.134.3.3 CheckDataElement() . . . . .	496
10.134.3.4 CheckTemplateFileName() . . . . .	496
10.134.3.5 New() . . . . .	496
10.134.3.6 ReserveDataElement() . . . . .	496
10.134.3.7 ReserveGroupDataElement() . . . . .	497
10.134.3.8 SetOutputFileName() . . . . .	497
10.134.3.9 SetTemplateFileName() . . . . .	497
10.134.3.10 StartDataElement() . . . . .	497
10.134.3.11 StartGroupDataElement() . . . . .	497
10.134.3.12 StopDataElement() . . . . .	498
10.134.3.13 StopGroupDataElement() . . . . .	498
10.135 gdcM::FileWithName Class Reference . . . . .	498
10.135.1 Detailed Description . . . . .	500
10.135.2 Constructor & Destructor Documentation . . . . .	500
10.135.2.1 FileWithName() . . . . .	500
10.135.3 Member Data Documentation . . . . .	500
10.135.3.1 filename . . . . .	500
10.136 gdcM::FindPatientRootQuery Class Reference . . . . .	501
10.136.1 Detailed Description . . . . .	502
10.136.2 Constructor & Destructor Documentation . . . . .	502
10.136.2.1 FindPatientRootQuery() . . . . .	502
10.136.3 Member Function Documentation . . . . .	502
10.136.3.1 GetAbstractSyntaxUID() . . . . .	502
10.136.3.2 GetTagListByLevel() . . . . .	502
10.136.3.3 InitializeDataSet() . . . . .	503
10.136.3.4 ValidateQuery() . . . . .	503
10.136.4 Friends And Related Function Documentation . . . . .	503
10.136.4.1 QueryFactory . . . . .	503
10.137 gdcM::FindStudyRootQuery Class Reference . . . . .	504
10.137.1 Detailed Description . . . . .	505
10.137.2 Constructor & Destructor Documentation . . . . .	505

---

10.137.2.1 FindStudyRootQuery()	505
10.137.3 Member Function Documentation	505
10.137.3.1 GetAbstractSyntaxUID()	505
10.137.3.2 GetTagListByLevel()	505
10.137.3.3 InitializeDataSet()	506
10.137.3.4 ValidateQuery()	506
10.137.4 Friends And Related Function Documentation	506
10.137.4.1 QueryFactory	506
10.138 gdcM::Fragment Class Reference	507
10.138.1 Detailed Description	508
10.138.2 Constructor & Destructor Documentation	508
10.138.2.1 Fragment()	508
10.138.3 Member Function Documentation	508
10.138.3.1 ComputeLength()	509
10.138.3.2 GetLength()	509
10.138.3.3 Read()	509
10.138.3.4 ReadBacktrack()	509
10.138.3.5 ReadPreValue()	509
10.138.3.6 ReadValue()	510
10.138.3.7 Write()	510
10.138.4 Friends And Related Function Documentation	510
10.138.4.1 operator<<	510
10.139 gdcM::Global Class Reference	510
10.139.1 Detailed Description	511
10.139.2 Constructor & Destructor Documentation	511
10.139.2.1 Global() [1/2]	512
10.139.2.2 ~Global()	512
10.139.2.3 Global() [2/2]	512
10.139.3 Member Function Documentation	512
10.139.3.1 Append()	512
10.139.3.2 GetDefs()	512
10.139.3.3 GetDicts() [1/2]	513
10.139.3.4 GetDicts() [2/2]	513
10.139.3.5 GetInstance()	513
10.139.3.6 LoadResourcesFiles()	513
10.139.3.7 Locate()	514
10.139.3.8 operator=()	514
10.139.3.9 Prepend()	514
10.139.4 Friends And Related Function Documentation	514

---

10.139.4.1 operator<<	514
10.140 gdcM::GroupDict Class Reference	514
10.140.1 Detailed Description	515
10.140.2 Member Typedef Documentation	515
10.140.2.1 GroupStringVector	515
10.140.3 Constructor & Destructor Documentation	515
10.140.3.1 GroupDict()	516
10.140.3.2 ~GroupDict()	516
10.140.4 Member Function Documentation	516
10.140.4.1 Add()	516
10.140.4.2 GetAbbreviation()	516
10.140.4.3 GetName()	516
10.140.4.4 Insert()	516
10.140.4.5 Size()	517
10.140.5 Friends And Related Function Documentation	517
10.140.5.1 operator<<	517
10.141 gdcM::IconImageFilter Class Reference	517
10.141.1 Detailed Description	518
10.141.2 Constructor & Destructor Documentation	518
10.141.2.1 IconImageFilter()	518
10.141.2.2 ~IconImageFilter()	518
10.141.3 Member Function Documentation	519
10.141.3.1 Extract()	519
10.141.3.2 ExtractIconImages()	519
10.141.3.3 ExtractVeprolIconImages()	519
10.141.3.4 GetFile() [1/2]	519
10.141.3.5 GetFile() [2/2]	519
10.141.3.6 GetIconImage()	520
10.141.3.7 GetNumberOfIconImages()	520
10.141.3.8 SetFile()	520
10.142 gdcM::IconImageGenerator Class Reference	520
10.142.1 Detailed Description	521
10.142.2 Constructor & Destructor Documentation	521
10.142.2.1 IconImageGenerator()	522
10.142.2.2 ~IconImageGenerator()	522
10.142.3 Member Function Documentation	522
10.142.3.1 AutoPixelMinMax()	522
10.142.3.2 ConvertRGBToPaletteColor()	522
10.142.3.3 Generate()	522

---

10.142.3.4 GetIconImage()	523
10.142.3.5 GetPixmap() [1/2]	523
10.142.3.6 GetPixmap() [2/2]	523
10.142.3.7 SetOutputDimensions()	523
10.142.3.8 SetOutsideValuePixel()	523
10.142.3.9 SetPixelMinMax()	524
10.142.3.10 SetPixmap()	524
10.143 gdcmm::ignore_char Struct Reference	524
10.143.1 Constructor & Destructor Documentation	524
10.143.1.1 ignore_char()	525
10.143.2 Member Data Documentation	525
10.143.2.1 m_char	525
10.144 gdcmm::Image Class Reference	525
10.144.1 Detailed Description	527
10.144.2 Constructor & Destructor Documentation	527
10.144.2.1 Image()	527
10.144.2.2 ~Image()	528
10.144.3 Member Function Documentation	528
10.144.3.1 GetDirectionCosines() [1/2]	528
10.144.3.2 GetDirectionCosines() [2/2]	528
10.144.3.3 GetIntercept()	528
10.144.3.4 GetOrigin() [1/2]	528
10.144.3.5 GetOrigin() [2/2]	529
10.144.3.6 GetSlope()	529
10.144.3.7 GetSpacing() [1/2]	529
10.144.3.8 GetSpacing() [2/2]	529
10.144.3.9 Print()	529
10.144.3.10 SetDirectionCosines() [1/3]	530
10.144.3.11 SetDirectionCosines() [2/3]	530
10.144.3.12 SetDirectionCosines() [3/3]	530
10.144.3.13 SetIntercept()	530
10.144.3.14 SetOrigin() [1/3]	530
10.144.3.15 SetOrigin() [2/3]	531
10.144.3.16 SetOrigin() [3/3]	531
10.144.3.17 SetSlope()	531
10.144.3.18 SetSpacing() [1/2]	531
10.144.3.19 SetSpacing() [2/2]	531
10.145 gdcmm::ImageApplyLookupTable Class Reference	532
10.145.1 Detailed Description	534



---

10.145.2 Constructor & Destructor Documentation	534
10.145.2.1 ImageApplyLookupTable()	534
10.145.2.2 ~ImageApplyLookupTable()	534
10.145.3 Member Function Documentation	534
10.145.3.1 Apply()	534
10.145.3.2 SetRGB8()	534
10.146 gdcm::ImageChangePhotometricInterpretation Class Reference	535
10.146.1 Detailed Description	537
10.146.2 Constructor & Destructor Documentation	537
10.146.2.1 ImageChangePhotometricInterpretation()	537
10.146.2.2 ~ImageChangePhotometricInterpretation()	537
10.146.3 Member Function Documentation	537
10.146.3.1 Change()	538
10.146.3.2 ChangeMonochrome()	538
10.146.3.3 ChangeRGB2YBR()	538
10.146.3.4 ChangeYBR2RGB()	538
10.146.3.5 GetPhotometricInterpretation()	538
10.146.3.6 RGB2YBR()	538
10.146.3.7 SetPhotometricInterpretation()	539
10.146.3.8 YBR2RGB()	539
10.147 gdcm::ImageChangePlanarConfiguration Class Reference	539
10.147.1 Detailed Description	541
10.147.2 Constructor & Destructor Documentation	541
10.147.2.1 ImageChangePlanarConfiguration()	541
10.147.2.2 ~ImageChangePlanarConfiguration()	541
10.147.3 Member Function Documentation	541
10.147.3.1 Change()	541
10.147.3.2 GetPlanarConfiguration()	542
10.147.3.3 RGBPixelsToRGBPlanes()	542
10.147.3.4 RGBPlanesToRGBPixels()	542
10.147.3.5 SetPlanarConfiguration()	542
10.148 gdcm::ImageChangeTransferSyntax Class Reference	543
10.148.1 Detailed Description	545
10.148.2 Constructor & Destructor Documentation	545
10.148.2.1 ImageChangeTransferSyntax()	545
10.148.2.2 ~ImageChangeTransferSyntax()	545
10.148.3 Member Function Documentation	546
10.148.3.1 Change()	546
10.148.3.2 GetTransferSyntax()	546

---

10.148.3.3 SetCompressIconImage()	546
10.148.3.4 SetForce()	546
10.148.3.5 SetTransferSyntax()	547
10.148.3.6 SetUserCodec()	547
10.148.3.7 TryJPEG2000Codec()	547
10.148.3.8 TryJPEGCodec()	547
10.148.3.9 TryJPEGLSCodec()	548
10.148.3.10 TryRAWCodec()	548
10.148.3.11 TryRLECodec()	548
10.149 gdcmm::ImageCodec Class Reference	548
10.149.1 Detailed Description	550
10.149.2 Member Typedef Documentation	551
10.149.2.1 LUTPtr	551
10.149.3 Constructor & Destructor Documentation	551
10.149.3.1 ImageCodec()	551
10.149.3.2 ~ImageCodec()	551
10.149.4 Member Function Documentation	551
10.149.4.1 AppendFrameEncode()	551
10.149.4.2 AppendRowEncode()	552
10.149.4.3 CanCode()	552
10.149.4.4 CanDecode()	552
10.149.4.5 CleanupUnusedBits()	552
10.149.4.6 Clone()	553
10.149.4.7 Decode()	553
10.149.4.8 DecodeByStreams()	553
10.149.4.9 DoByteSwap()	553
10.149.4.10 DoInvertMonochrome()	554
10.149.4.11 DoOverlayCleanup()	554
10.149.4.12 DoPaddedCompositePixelCode()	554
10.149.4.13 DoPlanarConfiguration()	554
10.149.4.14 DoSimpleCopy()	554
10.149.4.15 DoYBR()	554
10.149.4.16 DoYBRFull422()	555
10.149.4.17 GetDimensions()	555
10.149.4.18 GetHeaderInfo()	555
10.149.4.19 GetLossyFlag()	555
10.149.4.20 GetLUT()	555
10.149.4.21 GetNeedByteSwap()	555
10.149.4.22 GetNumberOfDimensions()	556

---

10.149.4.23	GetPhotometricInterpretation()	556
10.149.4.24	GetPixelFormat() [1/2]	556
10.149.4.25	GetPixelFormat() [2/2]	556
10.149.4.26	GetPlanarConfiguration()	556
10.149.4.27	IsFrameEncoder()	556
10.149.4.28	IsLossy()	557
10.149.4.29	IsRowEncoder()	557
10.149.4.30	IsValid()	557
10.149.4.31	SetDimensions() [1/2]	557
10.149.4.32	SetDimensions() [2/2]	557
10.149.4.33	SetLossyFlag()	558
10.149.4.34	SetLUT()	558
10.149.4.35	SetNeedByteSwap()	558
10.149.4.36	SetNeedOverlayCleanup()	558
10.149.4.37	SetNumberOfDimensions()	558
10.149.4.38	SetPhotometricInterpretation()	559
10.149.4.39	SetPixelFormat()	559
10.149.4.40	SetPlanarConfiguration()	559
10.149.4.41	StartEncode()	559
10.149.4.42	StopEncode()	559
10.149.5	Friends And Related Function Documentation	560
10.149.5.1	FileChangeTransferSyntax	560
10.149.5.2	ImageChangePhotometricInterpretation	560
10.149.6	Member Data Documentation	560
10.149.6.1	Dimensions	560
10.149.6.2	LossyFlag	560
10.149.6.3	LUT	560
10.149.6.4	NeedByteSwap	561
10.149.6.5	NeedOverlayCleanup	561
10.149.6.6	NumberOfDimensions	561
10.149.6.7	PF	561
10.149.6.8	PI	561
10.149.6.9	PlanarConfiguration	561
10.149.6.10	RequestPaddedCompositePixelCode	561
10.149.6.11	RequestPlanarConfiguration	562
10.150	gdcm::ImageConverter Class Reference	562
10.150.1	Detailed Description	562
10.150.2	Constructor & Destructor Documentation	562
10.150.2.1	ImageConverter()	562

---

10.150.2.2	~ImageConverter()	563
10.150.3	Member Function Documentation	563
10.150.3.1	Convert()	563
10.150.3.2	GetOutput()	563
10.150.3.3	SetInput()	563
10.151	gdcM::ImageFragmentSplitter Class Reference	564
10.151.1	Detailed Description	566
10.151.2	Constructor & Destructor Documentation	566
10.151.2.1	ImageFragmentSplitter()	566
10.151.2.2	~ImageFragmentSplitter()	566
10.151.3	Member Function Documentation	566
10.151.3.1	GetFragmentSizeMax()	566
10.151.3.2	SetForce()	566
10.151.3.3	SetFragmentSizeMax()	567
10.151.3.4	Split()	567
10.152	gdcM::ImageHelper Class Reference	567
10.152.1	Detailed Description	568
10.152.2	Member Function Documentation	568
10.152.2.1	ComputeMediaStorageFromModality()	568
10.152.2.2	ComputeSpacingFromImagePositionPatient()	569
10.152.2.3	GetDimensionsValue()	569
10.152.2.4	GetDirectionCosinesFromDataSet()	569
10.152.2.5	GetDirectionCosinesValue()	569
10.152.2.6	GetForcePixelSpacing()	569
10.152.2.7	GetForceRescaleInterceptSlope()	570
10.152.2.8	GetLUT()	570
10.152.2.9	GetOriginValue()	570
10.152.2.10	GetPhotometricInterpretationValue()	570
10.152.2.11	GetPixelFormatValue()	570
10.152.2.12	GetPlanarConfigurationValue()	570
10.152.2.13	GetPMSRescaleInterceptSlope()	571
10.152.2.14	GetPointerFromElement()	571
10.152.2.15	GetRealWorldValueMappingContent()	571
10.152.2.16	GetRescaleInterceptSlopeValue()	571
10.152.2.17	GetSpacingTagFromMediaStorage()	571
10.152.2.18	GetSpacingValue()	572
10.152.2.19	GetZSpacingTagFromMediaStorage()	572
10.152.2.20	SetDimensionsValue()	572
10.152.2.21	SetDirectionCosinesValue()	572

---

10.152.2.22 SetForcePixelSpacing()	572
10.152.2.23 SetForceRescaleInterceptSlope()	573
10.152.2.24 SetOriginValue()	573
10.152.2.25 SetPMSRescaleInterceptSlope()	573
10.152.2.26 SetRescaleInterceptSlopeValue()	573
10.152.2.27 SetSpacingValue()	573
10.153 gdcm::ImageReader Class Reference	574
10.153.1 Detailed Description	576
10.153.2 Constructor & Destructor Documentation	576
10.153.2.1 ImageReader()	576
10.153.2.2 ~ImageReader()	576
10.153.3 Member Function Documentation	576
10.153.3.1 GetImage() [1/2]	576
10.153.3.2 GetImage() [2/2]	577
10.153.3.3 Read()	577
10.153.3.4 ReadACRNEMAImage()	577
10.153.3.5 ReadImage()	578
10.154 gdcm::ImageRegionReader Class Reference	578
10.154.1 Detailed Description	580
10.154.2 Constructor & Destructor Documentation	580
10.154.2.1 ImageRegionReader()	580
10.154.2.2 ~ImageRegionReader()	580
10.154.3 Member Function Documentation	580
10.154.3.1 ComputeBufferLength()	581
10.154.3.2 GetRegion()	581
10.154.3.3 Read()	581
10.154.3.4 ReadInformation()	581
10.154.3.5 ReadIntoBuffer()	582
10.154.3.6 SetRegion()	582
10.155 gdcm::ImageToImageFilter Class Reference	582
10.155.1 Detailed Description	583
10.155.2 Constructor & Destructor Documentation	584
10.155.2.1 ImageToImageFilter()	584
10.155.2.2 ~ImageToImageFilter()	584
10.155.3 Member Function Documentation	584
10.155.3.1 GetInput()	584
10.155.3.2 GetOutput()	584
10.156 gdcm::ImageWriter Class Reference	585
10.156.1 Detailed Description	587

---

10.156.2 Constructor & Destructor Documentation	587
10.156.2.1 ImageWriter()	587
10.156.2.2 ~ImageWriter()	587
10.156.3 Member Function Documentation	587
10.156.3.1 ComputeTargetMediaStorage()	588
10.156.3.2 GetImage() [1/2]	588
10.156.3.3 GetImage() [2/2]	588
10.156.3.4 Write()	588
10.157 gdcn::network::ImplementationClassUIDSub Class Reference	589
10.157.1 Detailed Description	589
10.157.2 Constructor & Destructor Documentation	589
10.157.2.1 ImplementationClassUIDSub()	589
10.157.3 Member Function Documentation	589
10.157.3.1 Print()	589
10.157.3.2 Read()	590
10.157.3.3 Size()	590
10.157.3.4 Write()	590
10.158 gdcn::network::ImplementationUIDSub Class Reference	590
10.158.1 Detailed Description	590
10.158.2 Constructor & Destructor Documentation	590
10.158.2.1 ImplementationUIDSub()	591
10.158.3 Member Function Documentation	591
10.158.3.1 Write()	591
10.159 gdcn::network::ImplementationVersionNameSub Class Reference	591
10.159.1 Detailed Description	591
10.159.2 Constructor & Destructor Documentation	591
10.159.2.1 ImplementationVersionNameSub()	592
10.159.3 Member Function Documentation	592
10.159.3.1 Print()	592
10.159.3.2 Read()	592
10.159.3.3 Size()	592
10.159.3.4 Write()	592
10.160 gdcn::ImplicitDataElement Class Reference	593
10.160.1 Detailed Description	594
10.160.2 Member Function Documentation	594
10.160.2.1 GetLength()	594
10.160.2.2 Read()	594
10.160.2.3 ReadPreValue()	594
10.160.2.4 ReadValue()	595

---

10.160.2.5 ReadValueWithLength()	595
10.160.2.6 ReadWithLength()	595
10.160.2.7 Write()	595
10.161 gdcM::InitializeEvent Class Reference	596
10.162 gdcM::IOD Class Reference	597
10.162.1 Detailed Description	597
10.162.2 Member Typedef Documentation	597
10.162.2.1 MapIOEntry	598
10.162.2.2 SizeType	598
10.162.3 Constructor & Destructor Documentation	598
10.162.3.1 IOD()	598
10.162.4 Member Function Documentation	598
10.162.4.1 AddIOEntry()	598
10.162.4.2 Clear()	598
10.162.4.3 GetIOEntry()	598
10.162.4.4 GetNumberOfIODs()	599
10.162.4.5 GetTypeFromTag()	599
10.162.5 Friends And Related Function Documentation	599
10.162.5.1 operator<<	599
10.163 gdcM::IOEntry Class Reference	599
10.163.1 Detailed Description	600
10.163.2 Constructor & Destructor Documentation	600
10.163.2.1 IOEntry()	600
10.163.3 Member Function Documentation	600
10.163.3.1 GetIE()	601
10.163.3.2 GetName()	601
10.163.3.3 GetRef()	601
10.163.3.4 GetUsage()	601
10.163.3.5 GetUsageType()	601
10.163.3.6 SetIE()	601
10.163.3.7 SetName()	601
10.163.3.8 SetRef()	602
10.163.3.9 SetUsage()	602
10.163.4 Friends And Related Function Documentation	602
10.163.4.1 operator<<	602
10.164 gdcM::IODs Class Reference	602
10.164.1 Detailed Description	603
10.164.2 Member Typedef Documentation	603
10.164.2.1 IODMapType	603

---

10.164.2.2 IODMapTypeConstIterator	603
10.164.2.3 IODName	604
10.164.3 Constructor & Destructor Documentation	604
10.164.3.1 IODs()	604
10.164.4 Member Function Documentation	604
10.164.4.1 AddIOD()	604
10.164.4.2 Begin()	604
10.164.4.3 Clear()	604
10.164.4.4 End()	605
10.164.4.5 GetIOD()	605
10.164.5 Friends And Related Function Documentation	605
10.164.5.1 operator<<	605
10.165 gdcmm::IPPSorter Class Reference	605
10.165.1 Detailed Description	606
10.165.2 Constructor & Destructor Documentation	607
10.165.2.1 IPPSorter()	607
10.165.3 Member Function Documentation	607
10.165.3.1 GetDirectionCosinesTolerance()	607
10.165.3.2 GetZSpacing()	608
10.165.3.3 GetZSpacingTolerance()	608
10.165.3.4 SetComputeZSpacing()	608
10.165.3.5 SetDirectionCosinesTolerance()	608
10.165.3.6 SetDropDuplicatePositions()	609
10.165.3.7 SetZSpacingTolerance()	609
10.165.3.8 Sort()	609
10.165.4 Member Data Documentation	609
10.165.4.1 ComputeZSpacing	609
10.165.4.2 DirCosTolerance	610
10.165.4.3 DropDuplicatePositions	610
10.165.4.4 ZSpacing	610
10.165.4.5 ZTolerance	610
10.166 gdcmm::Item Class Reference	610
10.166.1 Detailed Description	612
10.166.2 Constructor & Destructor Documentation	612
10.166.2.1 Item() [1/2]	612
10.166.2.2 Item() [2/2]	612
10.166.3 Member Function Documentation	612
10.166.3.1 Clear()	613
10.166.3.2 FindDataElement()	613



---

10.166.3.3 GetDataElement()	613
10.166.3.4 GetLength()	613
10.166.3.5 GetNestedDataSet() [1/2]	613
10.166.3.6 GetNestedDataSet() [2/2]	613
10.166.3.7 InsertDataElement()	614
10.166.3.8 Read()	614
10.166.3.9 SetNestedDataSet()	614
10.166.3.10 Write()	614
10.166.4 Friends And Related Function Documentation	614
10.166.4.1 operator<<	614
10.167 gdcM::IterationEvent Class Reference	615
10.168 gdcM::JPEG12Codec Class Reference	616
10.168.1 Detailed Description	617
10.168.2 Constructor & Destructor Documentation	617
10.168.2.1 JPEG12Codec()	617
10.168.2.2 ~JPEG12Codec()	617
10.168.3 Member Function Documentation	617
10.168.3.1 DecodeByStreams()	618
10.168.3.2 EncodeBuffer()	618
10.168.3.3 GetHeaderInfo()	618
10.168.3.4 InternalCode()	618
10.168.3.5 IsStateSuspension()	618
10.169 gdcM::JPEG16Codec Class Reference	619
10.169.1 Detailed Description	620
10.169.2 Constructor & Destructor Documentation	620
10.169.2.1 JPEG16Codec()	620
10.169.2.2 ~JPEG16Codec()	620
10.169.3 Member Function Documentation	620
10.169.3.1 DecodeByStreams()	621
10.169.3.2 EncodeBuffer()	621
10.169.3.3 GetHeaderInfo()	621
10.169.3.4 InternalCode()	621
10.169.3.5 IsStateSuspension()	621
10.170 gdcM::JPEG2000Codec Class Reference	622
10.170.1 Detailed Description	623
10.170.2 Constructor & Destructor Documentation	624
10.170.2.1 JPEG2000Codec()	624
10.170.2.2 ~JPEG2000Codec()	624
10.170.3 Member Function Documentation	624

---

10.170.3.1 AppendFrameEncode()	624
10.170.3.2 AppendRowEncode()	624
10.170.3.3 CanCode()	625
10.170.3.4 CanDecode()	625
10.170.3.5 Clone()	625
10.170.3.6 Code()	625
10.170.3.7 Decode()	626
10.170.3.8 DecodeByStreams()	626
10.170.3.9 DecodeExtent()	626
10.170.3.10 GetHeaderInfo()	626
10.170.3.11 GetQuality()	627
10.170.3.12 GetRate()	627
10.170.3.13 IsFrameEncoder()	627
10.170.3.14 IsRowEncoder()	627
10.170.3.15 SetMCT()	627
10.170.3.16 SetNumberOfResolutions()	627
10.170.3.17 SetNumberOfThreadsForDecompression()	627
10.170.3.18 SetQuality()	628
10.170.3.19 SetRate()	628
10.170.3.20 SetReversible()	628
10.170.3.21 SetTileSize()	628
10.170.3.22 StartEncode()	628
10.170.3.23 StopEncode()	629
10.170.4 Friends And Related Function Documentation	629
10.170.4.1 Bitmap	629
10.170.4.2 ImageRegionReader	629
10.171 gdcmm::JPEG8Codec Class Reference	629
10.171.1 Detailed Description	631
10.171.2 Constructor & Destructor Documentation	631
10.171.2.1 JPEG8Codec()	631
10.171.2.2 ~JPEG8Codec()	631
10.171.3 Member Function Documentation	631
10.171.3.1 DecodeByStreams()	631
10.171.3.2 EncodeBuffer()	632
10.171.3.3 GetHeaderInfo()	632
10.171.3.4 InternalCode()	632
10.171.3.5 IsStateSuspension()	632
10.172 gdcmm::JPEGCodec Class Reference	633
10.172.1 Detailed Description	635

---

10.172.2 Constructor & Destructor Documentation	635
10.172.2.1 JPEGCodec()	635
10.172.2.2 ~JPEGCodec()	635
10.172.3 Member Function Documentation	635
10.172.3.1 AppendFrameEncode()	636
10.172.3.2 AppendRowEncode()	636
10.172.3.3 CanCode()	636
10.172.3.4 CanDecode()	636
10.172.3.5 Clone()	637
10.172.3.6 Code()	637
10.172.3.7 ComputeOffsetTable()	637
10.172.3.8 Decode()	637
10.172.3.9 DecodeByStreams()	637
10.172.3.10 DecodeExtent()	638
10.172.3.11 EncodeBuffer()	638
10.172.3.12 GetHeaderInfo()	638
10.172.3.13 GetLossless()	638
10.172.3.14 GetQuality()	639
10.172.3.15 IsFrameEncoder()	639
10.172.3.16 IsRowEncoder()	639
10.172.3.17 IsStateSuspension()	639
10.172.3.18 IsValid()	639
10.172.3.19 SetBitSample()	639
10.172.3.20 SetLossless()	640
10.172.3.21 SetPixelFormat()	640
10.172.3.22 SetQuality()	640
10.172.3.23 StartEncode()	640
10.172.3.24 StopEncode()	640
10.172.4 Friends And Related Function Documentation	641
10.172.4.1 ImageRegionReader	641
10.172.5 Member Data Documentation	641
10.172.5.1 BitSample	641
10.172.5.2 Quality	641
10.173 gdcm::JPEGLSCodec Class Reference	641
10.173.1 Detailed Description	643
10.173.2 Constructor & Destructor Documentation	643
10.173.2.1 JPEGLSCodec()	644
10.173.2.2 ~JPEGLSCodec()	644
10.173.3 Member Function Documentation	644

---

10.173.3.1 AppendFrameEncode()	644
10.173.3.2 AppendRowEncode()	644
10.173.3.3 CanCode()	644
10.173.3.4 CanDecode()	645
10.173.3.5 Clone()	645
10.173.3.6 Code()	645
10.173.3.7 Decode() [1/2]	645
10.173.3.8 Decode() [2/2]	646
10.173.3.9 DecodeExtent()	646
10.173.3.10 GetBufferLength()	646
10.173.3.11 GetHeaderInfo()	646
10.173.3.12 GetLossless()	646
10.173.3.13 IsFrameEncoder()	647
10.173.3.14 IsRowEncoder()	647
10.173.3.15 SetBufferLength()	647
10.173.3.16 SetLossless()	647
10.173.3.17 SetLossyError()	647
10.173.3.18 StartEncode()	647
10.173.3.19 StopEncode()	648
10.173.4 Friends And Related Function Documentation	648
10.173.4.1 ImageRegionReader	648
10.174 gdcM::JSON Class Reference	648
10.174.1 Detailed Description	648
10.174.2 Constructor & Destructor Documentation	648
10.174.2.1 JSON()	649
10.174.2.2 ~JSON()	649
10.174.3 Member Function Documentation	649
10.174.3.1 Code()	649
10.174.3.2 Decode()	649
10.174.3.3 GetPrettyPrint()	649
10.174.3.4 PrettyPrintOff()	650
10.174.3.5 PrettyPrintOn()	650
10.174.3.6 SetPrettyPrint()	650
10.175 gdcM::KAKADUCodec Class Reference	650
10.175.1 Detailed Description	652
10.175.2 Constructor & Destructor Documentation	652
10.175.2.1 KAKADUCodec()	652
10.175.2.2 ~KAKADUCodec()	652
10.175.3 Member Function Documentation	652

---

10.175.3.1 CanCode()	652
10.175.3.2 CanDecode()	652
10.175.3.3 Clone()	653
10.175.3.4 Code()	653
10.175.3.5 Decode()	653
10.176 gdcM::LO Class Reference	654
10.176.1 Detailed Description	655
10.176.2 Member Typedef Documentation	655
10.176.2.1 const_iterator	655
10.176.2.2 const_reference	655
10.176.2.3 const_reverse_iterator	655
10.176.2.4 difference_type	655
10.176.2.5 iterator	656
10.176.2.6 pointer	656
10.176.2.7 reference	656
10.176.2.8 reverse_iterator	656
10.176.2.9 size_type	656
10.176.2.10 Superclass	656
10.176.2.11 value_type	656
10.176.3 Constructor & Destructor Documentation	657
10.176.3.1 LO() [1/4]	657
10.176.3.2 LO() [2/4]	657
10.176.3.3 LO() [3/4]	657
10.176.3.4 LO() [4/4]	657
10.176.4 Member Function Documentation	657
10.176.4.1 IsValid()	657
10.177 gdcM::LookupTable Class Reference	658
10.177.1 Detailed Description	660
10.177.2 Member Enumeration Documentation	660
10.177.2.1 LookupTableType	660
10.177.3 Constructor & Destructor Documentation	660
10.177.3.1 LookupTable() [1/2]	660
10.177.3.2 ~LookupTable()	660
10.177.3.3 LookupTable() [2/2]	661
10.177.4 Member Function Documentation	661
10.177.4.1 Allocate()	661
10.177.4.2 Clear()	661
10.177.4.3 Decode() [1/2]	661
10.177.4.4 Decode() [2/2]	661

---

10.177.4.5 Decode8()	662
10.177.4.6 GetBitSample()	662
10.177.4.7 GetBufferAsRGBA()	662
10.177.4.8 GetLUT()	662
10.177.4.9 GetLUTDescriptor()	663
10.177.4.10 GetLUTLength()	663
10.177.4.11 GetPointer()	663
10.177.4.12 InitializeBlueLUT()	663
10.177.4.13 Initialized()	663
10.177.4.14 InitializeGreenLUT()	664
10.177.4.15 InitializeLUT()	664
10.177.4.16 InitializeRedLUT()	664
10.177.4.17 IsRGB8()	664
10.177.4.18 Print()	664
10.177.4.19 SetBlueLUT()	665
10.177.4.20 SetGreenLUT()	665
10.177.4.21 SetLUT()	665
10.177.4.22 SetRedLUT()	665
10.177.4.23 WriteBufferAsRGBA()	665
10.177.5 Member Data Documentation	665
10.177.5.1 BitSample	666
10.177.5.2 IncompleteLUT	666
10.177.5.3 Internal	666
10.178 gdcmm::Scanner::Itstr Struct Reference	666
10.178.1 Member Function Documentation	666
10.178.1.1 operator()	666
10.179 gdcmm::StrictScanner::Itstr Struct Reference	667
10.179.1 Member Function Documentation	667
10.179.1.1 operator()	667
10.180 gdcmm::Macro Class Reference	667
10.180.1 Detailed Description	668
10.180.2 Member Typedef Documentation	668
10.180.2.1 ArrayIncludeMacrosType	668
10.180.2.2 MapModuleEntry	668
10.180.3 Constructor & Destructor Documentation	668
10.180.3.1 Macro()	668
10.180.4 Member Function Documentation	668
10.180.4.1 AddMacroEntry()	669
10.180.4.2 Clear()	669

---

10.180.4.3 FindMacroEntry()	669
10.180.4.4 GetMacroEntry()	669
10.180.4.5 GetName()	669
10.180.4.6 SetName()	669
10.180.4.7 Verify()	670
10.180.5 Friends And Related Function Documentation	670
10.180.5.1 operator<<	670
10.181 gdcM::Macros Class Reference	670
10.181.1 Detailed Description	671
10.181.2 Member Typedef Documentation	671
10.181.2.1 ModuleMapType	671
10.181.3 Constructor & Destructor Documentation	671
10.181.3.1 Macros()	671
10.181.4 Member Function Documentation	671
10.181.4.1 AddMacro()	671
10.181.4.2 Clear()	672
10.181.4.3 GetMacro()	672
10.181.4.4 IsEmpty()	672
10.181.5 Friends And Related Function Documentation	672
10.181.5.1 operator<<	672
10.182 gdcM::network::MaximumLengthSub Class Reference	672
10.182.1 Detailed Description	673
10.182.2 Constructor & Destructor Documentation	673
10.182.2.1 MaximumLengthSub()	673
10.182.3 Member Function Documentation	673
10.182.3.1 GetMaximumLength()	673
10.182.3.2 Print()	673
10.182.3.3 Read()	674
10.182.3.4 SetMaximumLength()	674
10.182.3.5 Size()	674
10.182.3.6 Write()	674
10.183 gdcM::MD5 Class Reference	674
10.183.1 Detailed Description	675
10.183.2 Member Function Documentation	675
10.183.2.1 Compute()	675
10.183.2.2 ComputeFile()	675
10.184 gdcM::MediaStorage Class Reference	675
10.184.1 Detailed Description	679
10.184.2 Member Enumeration Documentation	679

10.184.2.1	MSType	679
10.184.2.2	ObjectType	682
10.184.3	Constructor & Destructor Documentation	682
10.184.3.1	MediaStorage()	682
10.184.4	Member Function Documentation	682
10.184.4.1	GetModality()	682
10.184.4.2	GetModalityDimension()	683
10.184.4.3	GetMSString()	683
10.184.4.4	GetMSType()	683
10.184.4.5	GetNumberOfModality()	683
10.184.4.6	GetNumberOfMSString()	683
10.184.4.7	GetNumberOfMSType()	684
10.184.4.8	GetString()	684
10.184.4.9	GuessFromModality()	684
10.184.4.10	IsImage()	684
10.184.4.11	IsUndefined()	685
10.184.4.12	operator MSType()	685
10.184.4.13	SetFromDataSet()	685
10.184.4.14	SetFromFile()	685
10.184.4.15	SetFromHeader()	685
10.184.4.16	SetFromModality()	686
10.184.4.17	SetFromSourceImageSequence()	686
10.184.5	Friends And Related Function Documentation	686
10.184.5.1	operator<<	686
10.185	gdcM::MemberCommand< T > Class Template Reference	686
10.185.1	Detailed Description	688
10.185.2	Member Typedef Documentation	688
10.185.2.1	Self	689
10.185.2.2	TConstMemberFunctionPointer	689
10.185.2.3	TMemberFunctionPointer	689
10.185.3	Constructor & Destructor Documentation	689
10.185.3.1	MemberCommand() [1/2]	689
10.185.3.2	MemberCommand() [2/2]	689
10.185.3.3	~MemberCommand()	690
10.185.4	Member Function Documentation	690
10.185.4.1	Execute() [1/2]	690
10.185.4.2	Execute() [2/2]	690
10.185.4.3	New()	690
10.185.4.4	operator=()	691



---

10.185.4.5 SetCallbackFunction() [1/2]	691
10.185.4.6 SetCallbackFunction() [2/2]	691
10.185.5 Member Data Documentation	691
10.185.5.1 m_ConstMemberFunction	691
10.185.5.2 m_MemberFunction	692
10.185.5.3 m_This	692
10.186 gdcM::MeshPrimitive Class Reference	692
10.186.1 Detailed Description	694
10.186.2 Member Typedef Documentation	694
10.186.2.1 PrimitivesData	694
10.186.3 Member Enumeration Documentation	694
10.186.3.1 MPTType	694
10.186.4 Constructor & Destructor Documentation	695
10.186.4.1 MeshPrimitive()	695
10.186.4.2 ~MeshPrimitive()	695
10.186.5 Member Function Documentation	695
10.186.5.1 AddPrimitiveData()	695
10.186.5.2 GetMPTType()	695
10.186.5.3 GetMPTTypeString()	696
10.186.5.4 GetNumberOfPrimitivesData()	696
10.186.5.5 GetPrimitiveData() [1/4]	696
10.186.5.6 GetPrimitiveData() [2/4]	696
10.186.5.7 GetPrimitiveData() [3/4]	696
10.186.5.8 GetPrimitiveData() [4/4]	696
10.186.5.9 GetPrimitivesData() [1/2]	696
10.186.5.10 GetPrimitivesData() [2/2]	697
10.186.5.11 GetPrimitiveType()	697
10.186.5.12 SetPrimitiveData() [1/2]	697
10.186.5.13 SetPrimitiveData() [2/2]	697
10.186.5.14 SetPrimitivesData()	697
10.186.5.15 SetPrimitiveType()	697
10.186.6 Member Data Documentation	697
10.186.6.1 PrimitiveData	698
10.186.6.2 PrimitiveType	698
10.187 gdcM::ModalityPerformedProcedureStepCreateQuery Class Reference	698
10.187.1 Detailed Description	699
10.187.2 Constructor & Destructor Documentation	700
10.187.2.1 ModalityPerformedProcedureStepCreateQuery()	700
10.187.3 Member Function Documentation	700

10.187.3.1	GetAbstractSyntaxUID()	700
10.187.3.2	GetRequiredDataSet()	700
10.187.3.3	ValidateQuery()	700
10.187.4	Friends And Related Function Documentation	700
10.187.4.1	QueryFactory	701
10.188	gdcM::ModalityPerformedProcedureStepSetQuery Class Reference	701
10.188.1	Detailed Description	702
10.188.2	Constructor & Destructor Documentation	703
10.188.2.1	ModalityPerformedProcedureStepSetQuery()	703
10.188.3	Member Function Documentation	703
10.188.3.1	GetAbstractSyntaxUID()	703
10.188.3.2	GetRequiredDataSet()	703
10.188.3.3	ValidateQuery()	703
10.188.4	Friends And Related Function Documentation	703
10.188.4.1	QueryFactory	704
10.189	gdcM::ModifiedEvent Class Reference	704
10.190	gdcM::Module Class Reference	705
10.190.1	Detailed Description	705
10.190.2	Member Typedef Documentation	706
10.190.2.1	ArrayIncludeMacrosType	706
10.190.2.2	MapModuleEntry	706
10.190.3	Constructor & Destructor Documentation	706
10.190.3.1	Module()	706
10.190.4	Member Function Documentation	706
10.190.4.1	AddMacro()	706
10.190.4.2	AddModuleEntry()	706
10.190.4.3	Clear()	707
10.190.4.4	FindModuleEntryInMacros()	707
10.190.4.5	GetModuleEntryInMacros()	707
10.190.4.6	GetName()	707
10.190.4.7	SetName()	707
10.190.4.8	Verify()	707
10.190.5	Friends And Related Function Documentation	707
10.190.5.1	operator<<	708
10.191	gdcM::ModuleEntry Class Reference	708
10.191.1	Detailed Description	710
10.191.2	Member Typedef Documentation	710
10.191.2.1	Description	710
10.191.3	Constructor & Destructor Documentation	710

---

10.191.3.1	ModuleEntry()	. 710
10.191.3.2	~ModuleEntry()	. 710
10.191.4	Member Function Documentation	. 710
10.191.4.1	GetDescription()	. 711
10.191.4.2	GetName()	. 711
10.191.4.3	GetType()	. 711
10.191.4.4	SetDescription()	. 711
10.191.4.5	SetName()	. 711
10.191.4.6	SetType()	. 711
10.191.5	Friends And Related Function Documentation	. 711
10.191.5.1	operator<<	. 712
10.191.6	Member Data Documentation	. 712
10.191.6.1	DataElementType	. 712
10.191.6.2	DescriptionField	. 712
10.191.6.3	Name	. 712
10.192	gdcM::Modules Class Reference	. 712
10.192.1	Detailed Description	. 713
10.192.2	Member Typedef Documentation	. 713
10.192.2.1	ModuleMapType	. 713
10.192.3	Constructor & Destructor Documentation	. 713
10.192.3.1	Modules()	. 713
10.192.4	Member Function Documentation	. 714
10.192.4.1	AddModule()	. 714
10.192.4.2	Clear()	. 714
10.192.4.3	GetModule()	. 714
10.192.4.4	IsEmpty()	. 714
10.192.5	Friends And Related Function Documentation	. 714
10.192.5.1	operator<<	. 714
10.193	gdcM::MovePatientRootQuery Class Reference	. 715
10.193.1	Detailed Description	. 716
10.193.2	Constructor & Destructor Documentation	. 716
10.193.2.1	MovePatientRootQuery()	. 716
10.193.3	Member Function Documentation	. 716
10.193.3.1	GetAbstractSyntaxUID()	. 716
10.193.3.2	GetTagListByLevel()	. 716
10.193.3.3	InitializeDataSet()	. 717
10.193.3.4	ValidateQuery()	. 717
10.193.4	Friends And Related Function Documentation	. 717
10.193.4.1	QueryFactory	. 717

---

10.194 gdcM::MoveStudyRootQuery Class Reference . . . . .	718
10.194.1 Detailed Description . . . . .	719
10.194.2 Constructor & Destructor Documentation . . . . .	719
10.194.2.1 MoveStudyRootQuery() . . . . .	719
10.194.3 Member Function Documentation . . . . .	719
10.194.3.1 GetAbstractSyntaxUID() . . . . .	719
10.194.3.2 GetTagListByLevel() . . . . .	719
10.194.3.3 InitializeDataSet() . . . . .	720
10.194.3.4 ValidateQuery() . . . . .	720
10.194.4 Friends And Related Function Documentation . . . . .	720
10.194.4.1 QueryFactory . . . . .	720
10.195 gdcM::MrProtocol Class Reference . . . . .	720
10.195.1 Detailed Description . . . . .	721
10.195.2 Constructor & Destructor Documentation . . . . .	721
10.195.2.1 MrProtocol() . . . . .	721
10.195.2.2 ~MrProtocol() . . . . .	721
10.195.3 Member Function Documentation . . . . .	722
10.195.3.1 FindMrProtocolByName() . . . . .	722
10.195.3.2 GetMrProtocolByName() . . . . .	722
10.195.3.3 GetSliceArray() . . . . .	722
10.195.3.4 GetVersion() . . . . .	722
10.195.3.5 Load() . . . . .	722
10.195.3.6 Print() . . . . .	722
10.195.4 Friends And Related Function Documentation . . . . .	723
10.195.4.1 operator<< . . . . .	723
10.196 gdcM::network::NActionRQ Class Reference . . . . .	723
10.196.1 Detailed Description . . . . .	724
10.196.2 Member Function Documentation . . . . .	724
10.196.2.1 ConstructPDV() . . . . .	724
10.197 gdcM::network::NActionRSP Class Reference . . . . .	724
10.197.1 Detailed Description . . . . .	725
10.197.2 Member Function Documentation . . . . .	725
10.197.2.1 ConstructPDVByDataSet() . . . . .	725
10.198 gdcM::network::NCreateRQ Class Reference . . . . .	726
10.198.1 Detailed Description . . . . .	726
10.198.2 Member Function Documentation . . . . .	727
10.198.2.1 ConstructPDV() . . . . .	727
10.199 gdcM::network::NCreateRSP Class Reference . . . . .	727
10.199.1 Detailed Description . . . . .	728

---

10.199.2 Member Function Documentation . . . . .	728
10.199.2.1 ConstructPDVByDataSet() . . . . .	728
10.200 gdcM::network::NDeleteRQ Class Reference . . . . .	729
10.200.1 Detailed Description . . . . .	729
10.200.2 Member Function Documentation . . . . .	730
10.200.2.1 ConstructPDV() . . . . .	730
10.201 gdcM::network::NDeleteRSP Class Reference . . . . .	730
10.201.1 Detailed Description . . . . .	731
10.201.2 Member Function Documentation . . . . .	731
10.201.2.1 ConstructPDVByDataSet() . . . . .	731
10.202 gdcM::NestedModuleEntries Class Reference . . . . .	732
10.202.1 Detailed Description . . . . .	733
10.202.2 Member Typedef Documentation . . . . .	733
10.202.2.1 SizeType . . . . .	733
10.202.3 Constructor & Destructor Documentation . . . . .	733
10.202.3.1 NestedModuleEntries() . . . . .	734
10.202.4 Member Function Documentation . . . . .	734
10.202.4.1 AddModuleEntry() . . . . .	734
10.202.4.2 GetModuleEntry() [1/2] . . . . .	734
10.202.4.3 GetModuleEntry() [2/2] . . . . .	734
10.202.4.4 GetNumberOfModuleEntries() . . . . .	734
10.202.5 Friends And Related Function Documentation . . . . .	734
10.202.5.1 operator<< . . . . .	735
10.203 gdcM::network::NEventReportRQ Class Reference . . . . .	735
10.203.1 Detailed Description . . . . .	736
10.203.2 Member Function Documentation . . . . .	736
10.203.2.1 ConstructPDV() . . . . .	736
10.204 gdcM::network::NEventReportRSP Class Reference . . . . .	736
10.204.1 Detailed Description . . . . .	737
10.204.2 Member Function Documentation . . . . .	737
10.204.2.1 ConstructPDVByDataSet() . . . . .	737
10.205 gdcM::network::NGetRQ Class Reference . . . . .	738
10.205.1 Detailed Description . . . . .	738
10.205.2 Member Function Documentation . . . . .	739
10.205.2.1 ConstructPDV() . . . . .	739
10.206 gdcM::network::NGetRSP Class Reference . . . . .	739
10.206.1 Detailed Description . . . . .	740
10.206.2 Member Function Documentation . . . . .	740
10.206.2.1 ConstructPDVByDataSet() . . . . .	740

---

10.207 gdcM::NoEvent Class Reference	741
10.207.1 Detailed Description	741
10.208 gdcM::network::NormalizedMessageFactory Class Reference	742
10.208.1 Member Function Documentation	742
10.208.1.1 ConstructNAction()	742
10.208.1.2 ConstructNCreate()	742
10.208.1.3 ConstructNDelete()	743
10.208.1.4 ConstructNEventReport()	743
10.208.1.5 ConstructNGet()	743
10.208.1.6 ConstructNSet()	743
10.209 gdcM::NormalizedNetworkFunctions Class Reference	743
10.209.1 Detailed Description	744
10.209.2 Member Function Documentation	744
10.209.2.1 ConstructQuery()	744
10.209.2.2 NAction()	745
10.209.2.3 NCreate()	745
10.209.2.4 NDelete()	745
10.209.2.5 NEventReport()	745
10.209.2.6 NGet()	746
10.209.2.7 NSet()	746
10.210 gdcM::network::NSetRQ Class Reference	746
10.210.1 Detailed Description	747
10.210.2 Member Function Documentation	747
10.210.2.1 ConstructPDV()	747
10.211 gdcM::network::NSetRSP Class Reference	748
10.211.1 Detailed Description	748
10.211.2 Member Function Documentation	749
10.211.2.1 ConstructPDVByDataSet()	749
10.212 gdcM::Object Class Reference	749
10.212.1 Detailed Description	751
10.212.2 Constructor & Destructor Documentation	751
10.212.2.1 Object() [1/2]	751
10.212.2.2 ~Object()	751
10.212.2.3 Object() [2/2]	751
10.212.3 Member Function Documentation	752
10.212.3.1 operator=()	752
10.212.3.2 Print()	752
10.212.3.3 Register()	752
10.212.3.4 UnRegister()	752

---

10.212.4 Friends And Related Function Documentation	752
10.212.4.1 operator<<	753
10.212.4.2 SmartPointer	753
10.213 gdcM::OpenSSLCryptoFactory Class Reference	753
10.213.1 Constructor & Destructor Documentation	754
10.213.1.1 OpenSSLCryptoFactory()	754
10.213.2 Member Function Documentation	754
10.213.2.1 CreateCMSProvider()	754
10.213.2.2 InitOpenSSL()	754
10.214 gdcM::OpenSSLCryptographicMessageSyntax Class Reference	755
10.214.1 Constructor & Destructor Documentation	756
10.214.1.1 OpenSSLCryptographicMessageSyntax()	756
10.214.1.2 ~OpenSSLCryptographicMessageSyntax()	756
10.214.2 Member Function Documentation	756
10.214.2.1 Decrypt()	756
10.214.2.2 Encrypt()	757
10.214.2.3 GetCipherType()	757
10.214.2.4 ParseCertificateFile()	757
10.214.2.5 ParseKeyFile()	757
10.214.2.6 SetCipherType()	757
10.214.2.7 SetPassword()	758
10.215 gdcM::OpenSSLP7CryptoFactory Class Reference	758
10.215.1 Constructor & Destructor Documentation	759
10.215.1.1 OpenSSLP7CryptoFactory()	759
10.215.2 Member Function Documentation	759
10.215.2.1 CreateCMSProvider()	759
10.216 gdcM::OpenSSLP7CryptographicMessageSyntax Class Reference	760
10.216.1 Detailed Description	761
10.216.2 Constructor & Destructor Documentation	761
10.216.2.1 OpenSSLP7CryptographicMessageSyntax()	761
10.216.2.2 ~OpenSSLP7CryptographicMessageSyntax()	761
10.216.3 Member Function Documentation	761
10.216.3.1 Decrypt()	761
10.216.3.2 Encrypt()	762
10.216.3.3 GetCipherType()	762
10.216.3.4 ParseCertificateFile()	762
10.216.3.5 ParseKeyFile()	762
10.216.3.6 SetCipherType()	762
10.216.3.7 SetPassword()	763

---

10.217 gdcM::Orientation Class Reference . . . . .	763
10.217.1 Detailed Description . . . . .	764
10.217.2 Member Enumeration Documentation . . . . .	764
10.217.2.1 OrientationType . . . . .	764
10.217.3 Constructor & Destructor Documentation . . . . .	764
10.217.3.1 Orientation() . . . . .	764
10.217.3.2 ~Orientation() . . . . .	764
10.217.4 Member Function Documentation . . . . .	765
10.217.4.1 GetLabel() . . . . .	765
10.217.4.2 GetMajorAxisFromPatientRelativeDirectionCosine() . . . . .	765
10.217.4.3 GetObliquityThresholdCosineValue() . . . . .	765
10.217.4.4 GetType() . . . . .	765
10.217.4.5 Print() . . . . .	766
10.217.4.6 SetObliquityThresholdCosineValue() . . . . .	766
10.217.5 Friends And Related Function Documentation . . . . .	766
10.217.5.1 operator<< . . . . .	766
10.218 gdcM::Overlay Class Reference . . . . .	766
10.218.1 Detailed Description . . . . .	769
10.218.2 Member Enumeration Documentation . . . . .	769
10.218.2.1 OverlayType . . . . .	769
10.218.3 Constructor & Destructor Documentation . . . . .	770
10.218.3.1 Overlay() [1/2] . . . . .	770
10.218.3.2 ~Overlay() . . . . .	770
10.218.3.3 Overlay() [2/2] . . . . .	770
10.218.4 Member Function Documentation . . . . .	770
10.218.4.1 Decompress() . . . . .	770
10.218.4.2 GetBitPosition() . . . . .	770
10.218.4.3 GetBitsAllocated() . . . . .	771
10.218.4.4 GetColumns() . . . . .	771
10.218.4.5 GetDescription() . . . . .	771
10.218.4.6 GetGroup() . . . . .	771
10.218.4.7 GetOrigin() . . . . .	771
10.218.4.8 GetOverlayData() . . . . .	771
10.218.4.9 GetOverlayTypeAsString() . . . . .	772
10.218.4.10 GetOverlayTypeFromString() . . . . .	772
10.218.4.11 GetRows() . . . . .	772
10.218.4.12 GetType() . . . . .	772
10.218.4.13 GetTypeAsEnum() . . . . .	772
10.218.4.14 GetUnpackBuffer() . . . . .	772



---

10.218.4.15	GetUnpackBufferLength()	773
10.218.4.16	GrabOverlayFromPixelData()	773
10.218.4.17	IsEmpty()	773
10.218.4.18	IsInPixelData() [1/2]	773
10.218.4.19	IsInPixelData() [2/2]	773
10.218.4.20	IsZero()	773
10.218.4.21	operator=()	774
10.218.4.22	Print()	774
10.218.4.23	SetBitPosition()	774
10.218.4.24	SetBitsAllocated()	774
10.218.4.25	SetColumns()	774
10.218.4.26	SetDescription()	775
10.218.4.27	SetFrameOrigin()	775
10.218.4.28	SetGroup()	775
10.218.4.29	SetNumberOfFrames()	775
10.218.4.30	SetOrigin()	775
10.218.4.31	SetOverlay()	776
10.218.4.32	SetRows()	776
10.218.4.33	SetType()	776
10.218.4.34	Update()	776
10.219	gdcM::ParseException Class Reference	777
10.219.1	Detailed Description	778
10.219.2	Constructor & Destructor Documentation	778
10.219.2.1	ParseException() [1/2]	778
10.219.2.2	~ParseException()	778
10.219.2.3	ParseException() [2/2]	778
10.219.3	Member Function Documentation	778
10.219.3.1	GetLastElement()	778
10.219.3.2	operator=()	779
10.219.3.3	SetLastElement()	779
10.220	gdcM::Parser Class Reference	779
10.220.1	Detailed Description	780
10.220.2	Member Typedef Documentation	780
10.220.2.1	EndElementHandler	780
10.220.2.2	StartElementHandler	780
10.220.3	Member Enumeration Documentation	781
10.220.3.1	ErrorType	781
10.220.4	Constructor & Destructor Documentation	782
10.220.4.1	Parser()	782

---

10.220.4.2 ~Parser()	782
10.220.5 Member Function Documentation	782
10.220.5.1 GetBuffer()	782
10.220.5.2 GetCurrentByteIndex()	782
10.220.5.3 GetErrorCode()	783
10.220.5.4 GetErrorString()	783
10.220.5.5 GetUserData()	783
10.220.5.6 Parse()	783
10.220.5.7 ParseBuffer()	783
10.220.5.8 Process()	783
10.220.5.9 SetElementHandler()	784
10.220.5.10 SetUserData()	784
10.221 gdcM::Patient Class Reference	784
10.221.1 Detailed Description	784
10.221.2 Constructor & Destructor Documentation	784
10.221.2.1 Patient()	784
10.222 gdcM::network::PDataTFPDU Class Reference	785
10.222.1 Detailed Description	786
10.222.2 Member Typedef Documentation	786
10.222.2.1 SizeType	786
10.222.3 Constructor & Destructor Documentation	786
10.222.3.1 PDataTFPDU()	786
10.222.4 Member Function Documentation	786
10.222.4.1 AddPresentationDataValue()	786
10.222.4.2 GetNumberOfPresentationDataValues()	787
10.222.4.3 GetPresentationDataValue()	787
10.222.4.4 IsLastFragment()	787
10.222.4.5 Print()	787
10.222.4.6 Read()	787
10.222.4.7 ReadInto()	787
10.222.4.8 Size()	788
10.222.4.9 Write()	788
10.223 gdcM::PDBelement Class Reference	788
10.223.1 Detailed Description	789
10.223.2 Constructor & Destructor Documentation	789
10.223.2.1 PDBelement()	789
10.223.3 Member Function Documentation	789
10.223.3.1 GetName()	790
10.223.3.2 GetValue()	790

---

10.223.3.3 operator==( ) . . . . .	790
10.223.3.4 SetName( ) . . . . .	790
10.223.3.5 SetValue( ) . . . . .	790
10.223.4 Friends And Related Function Documentation . . . . .	790
10.223.4.1 operator<< . . . . .	791
10.223.5 Member Data Documentation . . . . .	791
10.223.5.1 NameField . . . . .	791
10.223.5.2 ValueField . . . . .	791
10.224 gdcM::PDBHeader Class Reference . . . . .	791
10.224.1 Detailed Description . . . . .	792
10.224.2 Constructor & Destructor Documentation . . . . .	792
10.224.2.1 PDBHeader( ) . . . . .	792
10.224.2.2 ~PDBHeader( ) . . . . .	792
10.224.3 Member Function Documentation . . . . .	793
10.224.3.1 FindPDBElementByName( ) . . . . .	793
10.224.3.2 GetPDBEEnd( ) . . . . .	793
10.224.3.3 GetPDBElementByName( ) . . . . .	793
10.224.3.4 GetPDBInfoTag( ) . . . . .	793
10.224.3.5 LoadFromDataElement( ) . . . . .	794
10.224.3.6 Print( ) . . . . .	794
10.224.4 Friends And Related Function Documentation . . . . .	794
10.224.4.1 operator<< . . . . .	794
10.225 gdcM::PDFCodec Class Reference . . . . .	794
10.225.1 Detailed Description . . . . .	796
10.225.2 Constructor & Destructor Documentation . . . . .	796
10.225.2.1 PDFCodec( ) . . . . .	796
10.225.2.2 ~PDFCodec( ) . . . . .	796
10.225.3 Member Function Documentation . . . . .	796
10.225.3.1 CanCode( ) . . . . .	796
10.225.3.2 CanDecode( ) . . . . .	796
10.225.3.3 Decode( ) . . . . .	797
10.226 gdcM::network::PDUFactory Class Reference . . . . .	797
10.226.1 Detailed Description . . . . .	798
10.226.2 Member Function Documentation . . . . .	798
10.226.2.1 ConstructAbortPDU( ) . . . . .	798
10.226.2.2 ConstructPDU( ) . . . . .	798
10.226.2.3 ConstructReleasePDU( ) . . . . .	798
10.226.2.4 CreateCEchoPDU( ) . . . . .	798
10.226.2.5 CreateCFindPDU( ) . . . . .	798

---

10.226.2.6 CreateCMovePDU()	799
10.226.2.7 CreateCStoreRQPDU()	799
10.226.2.8 CreateCStoreRSPPDU()	799
10.226.2.9 CreateNActionPDU()	799
10.226.2.10 CreateNCreatePDU()	799
10.226.2.11 CreateNDeletePDU()	799
10.226.2.12 CreateNEventReportPDU()	800
10.226.2.13 CreateNGetPDU()	800
10.226.2.14 CreateNSetPDU()	800
10.226.2.15 DetermineEventByPDU()	800
10.226.2.16 GetPDVs()	800
10.227 gdcM::PersonName Class Reference	800
10.227.1 Detailed Description	801
10.227.2 Member Function Documentation	801
10.227.2.1 GetMaxLength()	801
10.227.2.2 GetNumberOfComponents()	801
10.227.2.3 Print()	802
10.227.2.4 SetBlob()	802
10.227.2.5 SetComponents() [1/2]	802
10.227.2.6 SetComponents() [2/2]	802
10.227.3 Member Data Documentation	802
10.227.3.1 Component	802
10.227.3.2 MaxLength	802
10.227.3.3 MaxNumberOfComponents	803
10.227.3.4 Padding	803
10.227.3.5 Separator	803
10.228 gdcM::PGXCodec Class Reference	803
10.228.1 Detailed Description	804
10.228.2 Constructor & Destructor Documentation	804
10.228.2.1 PGXCodec()	804
10.228.2.2 ~PGXCodec()	805
10.228.3 Member Function Documentation	805
10.228.3.1 CanCode()	805
10.228.3.2 CanDecode()	805
10.228.3.3 Clone()	805
10.228.3.4 GetHeaderInfo()	805
10.228.3.5 Read()	806
10.228.3.6 Write()	806
10.229 gdcM::PhotometricInterpretation Class Reference	806

---

10.229.1 Detailed Description . . . . .	807
10.229.2 Member Enumeration Documentation . . . . .	807
10.229.2.1 PType . . . . .	808
10.229.3 Constructor & Destructor Documentation . . . . .	808
10.229.3.1 PhotometricInterpretation() . . . . .	808
10.229.4 Member Function Documentation . . . . .	808
10.229.4.1 GetPString() . . . . .	808
10.229.4.2 GetPType() . . . . .	809
10.229.4.3 GetSamplesPerPixel() . . . . .	809
10.229.4.4 GetString() . . . . .	809
10.229.4.5 GetType() . . . . .	809
10.229.4.6 IsLossless() . . . . .	809
10.229.4.7 IsLossy() . . . . .	809
10.229.4.8 IsRetired() . . . . .	809
10.229.4.9 IsSameColorSpace() . . . . .	810
10.229.4.10 operator PType() . . . . .	810
10.229.5 Friends And Related Function Documentation . . . . .	810
10.229.5.1 operator<< . . . . .	810
10.230 gdcm::PixelFormat Class Reference . . . . .	810
10.230.1 Detailed Description . . . . .	812
10.230.2 Member Enumeration Documentation . . . . .	812
10.230.2.1 ScalarType . . . . .	812
10.230.3 Constructor & Destructor Documentation . . . . .	813
10.230.3.1 PixelFormat() [1/3] . . . . .	813
10.230.3.2 PixelFormat() [2/3] . . . . .	813
10.230.3.3 PixelFormat() [3/3] . . . . .	813
10.230.4 Member Function Documentation . . . . .	813
10.230.4.1 GetBitsAllocated() . . . . .	813
10.230.4.2 GetBitsStored() . . . . .	814
10.230.4.3 GetHighBit() . . . . .	814
10.230.4.4 GetMax() . . . . .	814
10.230.4.5 GetMin() . . . . .	814
10.230.4.6 GetPixelRepresentation() . . . . .	814
10.230.4.7 GetPixelSize() . . . . .	815
10.230.4.8 GetSamplesPerPixel() . . . . .	815
10.230.4.9 GetScalarType() . . . . .	815
10.230.4.10 GetScalarTypeAsString() . . . . .	815
10.230.4.11 IsCompatible() . . . . .	816
10.230.4.12 IsValid() . . . . .	816

---

10.230.4.13 operator ScalarType()	816
10.230.4.14 operator!=() [1/2]	816
10.230.4.15 operator!=() [2/2]	816
10.230.4.16 operator==() [1/2]	816
10.230.4.17 operator==() [2/2]	817
10.230.4.18 Print()	817
10.230.4.19 SetBitsAllocated()	817
10.230.4.20 SetBitsStored()	817
10.230.4.21 SetHighBit()	817
10.230.4.22 SetPixelRepresentation()	817
10.230.4.23 SetSamplesPerPixel()	818
10.230.4.24 SetScalarType()	818
10.230.4.25 Validate()	818
10.230.5 Friends And Related Function Documentation	818
10.230.5.1 Bitmap	818
10.230.5.2 operator<<	819
10.231 gdcM::Pixmap Class Reference	819
10.231.1 Detailed Description	821
10.231.2 Constructor & Destructor Documentation	821
10.231.2.1 Pixmap()	821
10.231.2.2 ~Pixmap()	821
10.231.3 Member Function Documentation	821
10.231.3.1 AreOverlaysInPixelData()	821
10.231.3.2 GetCurve() [1/2]	822
10.231.3.3 GetCurve() [2/2]	822
10.231.3.4 GetIconImage() [1/2]	822
10.231.3.5 GetIconImage() [2/2]	822
10.231.3.6 GetNumberOfCurves()	822
10.231.3.7 GetNumberOfOverlays()	822
10.231.3.8 GetOverlay() [1/2]	823
10.231.3.9 GetOverlay() [2/2]	823
10.231.3.10 Print()	823
10.231.3.11 RemoveOverlay()	823
10.231.3.12 SetIconImage()	823
10.231.3.13 SetNumberOfCurves()	823
10.231.3.14 SetNumberOfOverlays()	824
10.231.3.15 UnusedBitsPresentInPixelData()	824
10.231.4 Member Data Documentation	824
10.231.4.1 Curves	824

---

10.231.4.2 Icon	824
10.231.4.3 Overlays	824
10.232 gdcM::PImageReader Class Reference	825
10.232.1 Detailed Description	827
10.232.2 Constructor & Destructor Documentation	827
10.232.2.1 PImageReader()	827
10.232.2.2 ~PImageReader()	827
10.232.3 Member Function Documentation	827
10.232.3.1 GetPImage() [1/2]	827
10.232.3.2 GetPImage() [2/2]	828
10.232.3.3 Read()	828
10.232.3.4 ReadACRNEMAIImage()	828
10.232.3.5 ReadImage()	828
10.232.3.6 ReadImageInternal()	828
10.232.4 Member Data Documentation	829
10.232.4.1 PixelData	829
10.233 gdcM::PImageToPImageFilter Class Reference	829
10.233.1 Detailed Description	830
10.233.2 Constructor & Destructor Documentation	831
10.233.2.1 PImageToPImageFilter()	831
10.233.2.2 ~PImageToPImageFilter()	831
10.233.3 Member Function Documentation	831
10.233.3.1 GetInput()	831
10.233.3.2 GetOutput()	831
10.233.3.3 GetOutputAsPImage()	831
10.234 gdcM::PImageWriter Class Reference	832
10.234.1 Detailed Description	834
10.234.2 Constructor & Destructor Documentation	834
10.234.2.1 PImageWriter()	834
10.234.2.2 ~PImageWriter()	834
10.234.3 Member Function Documentation	834
10.234.3.1 DoIConImage()	835
10.234.3.2 GetImage() [1/2]	835
10.234.3.3 GetImage() [2/2]	835
10.234.3.4 GetPImage() [1/2]	835
10.234.3.5 GetPImage() [2/2]	835
10.234.3.6 PrepareWrite()	835
10.234.3.7 SetImage()	836
10.234.3.8 SetPImage()	836

---

10.234.3.9 Write()	836
10.234.4 Member Data Documentation	836
10.234.4.1 PixelData	836
10.235 gdcM::PNMCodec Class Reference	837
10.235.1 Detailed Description	838
10.235.2 Constructor & Destructor Documentation	838
10.235.2.1 PNMCodec()	838
10.235.2.2 ~PNMCodec()	838
10.235.3 Member Function Documentation	838
10.235.3.1 CanCode()	839
10.235.3.2 CanDecode()	839
10.235.3.3 Clone()	839
10.235.3.4 GetBufferLength()	839
10.235.3.5 GetHeaderInfo()	839
10.235.3.6 Read()	840
10.235.3.7 SetBufferLength()	840
10.235.3.8 Write()	840
10.236 gdcM::Preamble Class Reference	840
10.236.1 Detailed Description	841
10.236.2 Constructor & Destructor Documentation	841
10.236.2.1 Preamble() [1/2]	842
10.236.2.2 ~Preamble()	842
10.236.2.3 Preamble() [2/2]	842
10.236.3 Member Function Documentation	842
10.236.3.1 Clear()	842
10.236.3.2 Create()	842
10.236.3.3 GetInternal()	842
10.236.3.4 GetLength()	843
10.236.3.5 IsEmpty()	843
10.236.3.6 IsValid()	843
10.236.3.7 operator=()	843
10.236.3.8 Print()	843
10.236.3.9 Read()	843
10.236.3.10 Remove()	844
10.236.3.11 Valid()	844
10.236.3.12 Write()	844
10.236.4 Friends And Related Function Documentation	844
10.236.4.1 operator<<	844
10.237 gdcM::PresentationContext Class Reference	845



---

10.237.1 Detailed Description	846
10.237.2 Member Typedef Documentation	846
10.237.2.1 SizeType	846
10.237.2.2 TransferSyntaxArrayType	846
10.237.3 Constructor & Destructor Documentation	846
10.237.3.1 PresentationContext() [1/2]	846
10.237.3.2 PresentationContext() [2/2]	847
10.237.4 Member Function Documentation	847
10.237.4.1 AddTransferSyntax()	847
10.237.4.2 GetAbstractSyntax()	847
10.237.4.3 GetNumberOfTransferSyntaxes()	847
10.237.4.4 GetPresentationContextID()	847
10.237.4.5 GetTransferSyntax()	847
10.237.4.6 operator==( )	848
10.237.4.7 Print()	848
10.237.4.8 SetAbstractSyntax()	848
10.237.4.9 SetPresentationContextID()	848
10.237.5 Member Data Documentation	848
10.237.5.1 AbstractSyntax	848
10.237.5.2 ID	848
10.237.5.3 TransferSyntaxes	849
10.238 gdcmm::network::PresentationContextAC Class Reference	849
10.238.1 Detailed Description	849
10.238.2 Constructor & Destructor Documentation	849
10.238.2.1 PresentationContextAC()	850
10.238.3 Member Function Documentation	850
10.238.3.1 GetPresentationContextID()	850
10.238.3.2 GetReason()	850
10.238.3.3 GetTransferSyntax()	850
10.238.3.4 Print()	850
10.238.3.5 Read()	850
10.238.3.6 SetPresentationContextID()	851
10.238.3.7 SetReason()	851
10.238.3.8 SetTransferSyntax()	851
10.238.3.9 Size()	851
10.238.3.10 Write()	851
10.239 gdcmm::PresentationContextGenerator Class Reference	851
10.239.1 Detailed Description	852
10.239.2 Member Typedef Documentation	853

---

10.239.2.1	PresentationContextArrayType	853
10.239.2.2	SizeType	853
10.239.3	Constructor & Destructor Documentation	853
10.239.3.1	PresentationContextGenerator()	853
10.239.4	Member Function Documentation	853
10.239.4.1	AddFromFile()	853
10.239.4.2	AddPresentationContext()	853
10.239.4.3	GenerateFromFilenames()	854
10.239.4.4	GenerateFromUID()	854
10.239.4.5	GetDefaultTransferSyntax()	854
10.239.4.6	GetPresentationContexts()	854
10.239.4.7	SetDefaultTransferSyntax()	854
10.239.4.8	SetMergeModeToAbstractSyntax()	855
10.239.4.9	SetMergeModeToTransferSyntax()	855
10.240	gdcm::network::PresentationContextRQ Class Reference	855
10.240.1	Detailed Description	856
10.240.2	Member Typedef Documentation	856
10.240.2.1	SizeType	856
10.240.3	Constructor & Destructor Documentation	856
10.240.3.1	PresentationContextRQ() [1/3]	856
10.240.3.2	PresentationContextRQ() [2/3]	856
10.240.3.3	PresentationContextRQ() [3/3]	856
10.240.4	Member Function Documentation	857
10.240.4.1	AddTransferSyntax()	857
10.240.4.2	GetAbstractSyntax() [1/2]	857
10.240.4.3	GetAbstractSyntax() [2/2]	857
10.240.4.4	GetNumberOfTransferSyntaxes()	857
10.240.4.5	GetPresentationContextID()	857
10.240.4.6	GetTransferSyntax() [1/2]	857
10.240.4.7	GetTransferSyntax() [2/2]	858
10.240.4.8	GetTransferSyntaxes()	858
10.240.4.9	operator==( )	858
10.240.4.10	Print()	858
10.240.4.11	Read()	858
10.240.4.12	SetAbstractSyntax()	858
10.240.4.13	SetPresentationContextID()	859
10.240.4.14	Size()	859
10.240.4.15	Write()	859
10.241	gdcm::network::PresentationDataValue Class Reference	859

---

10.241.1 Detailed Description	860
10.241.2 Constructor & Destructor Documentation	860
10.241.2.1 PresentationDataValue()	860
10.241.3 Member Function Documentation	860
10.241.3.1 ConcatenatePDVBlobs()	860
10.241.3.2 ConcatenatePDVBlobsAsExplicit()	860
10.241.3.3 GetBlob()	861
10.241.3.4 GetIsCommand()	861
10.241.3.5 GetIsLastFragment()	861
10.241.3.6 GetMessageHeader()	861
10.241.3.7 GetPresentationContextID()	861
10.241.3.8 Print()	861
10.241.3.9 Read()	861
10.241.3.10 ReadInto()	862
10.241.3.11 SetBlob()	862
10.241.3.12 SetCommand()	862
10.241.3.13 SetDataSet()	862
10.241.3.14 SetLastFragment()	862
10.241.3.15 SetMessageHeader()	863
10.241.3.16 SetPresentationContextID()	863
10.241.3.17 Size()	863
10.241.3.18 Write()	863
10.242 gdcm::Printer Class Reference	863
10.242.1 Detailed Description	865
10.242.2 Member Enumeration Documentation	865
10.242.2.1 PrintStyles	865
10.242.3 Constructor & Destructor Documentation	865
10.242.3.1 Printer()	865
10.242.3.2 ~Printer()	866
10.242.4 Member Function Documentation	866
10.242.4.1 GetPrintStyle()	866
10.242.4.2 Print()	866
10.242.4.3 PrintDataElement()	866
10.242.4.4 PrintDataSet()	867
10.242.4.5 PrintSQ()	867
10.242.4.6 SetColor()	867
10.242.4.7 SetFile()	867
10.242.4.8 SetStyle()	867
10.242.5 Member Data Documentation	868

---

10.242.5.1 F	868
10.242.5.2 MaxPrintLength	868
10.242.5.3 PrintStyle	868
10.243 gdcM::PrivateDict Class Reference	868
10.243.1 Detailed Description	869
10.243.2 Constructor & Destructor Documentation	869
10.243.2.1 PrivateDict()	869
10.243.2.2 ~PrivateDict()	869
10.243.3 Member Function Documentation	869
10.243.3.1 AddDictEntry()	869
10.243.3.2 FindDictEntry()	870
10.243.3.3 GetDictEntry()	870
10.243.3.4 IsEmpty()	870
10.243.3.5 LoadDefault()	870
10.243.3.6 PrintXML()	870
10.243.3.7 RemoveDictEntry()	870
10.243.4 Friends And Related Function Documentation	871
10.243.4.1 Dicts	871
10.243.4.2 operator<<	871
10.244 gdcM::PrivateTag Class Reference	871
10.244.1 Detailed Description	872
10.244.2 Constructor & Destructor Documentation	872
10.244.2.1 PrivateTag() [1/2]	873
10.244.2.2 PrivateTag() [2/2]	873
10.244.3 Member Function Documentation	873
10.244.3.1 GetAsDataElement()	873
10.244.3.2 GetOwner()	873
10.244.3.3 operator<()	873
10.244.3.4 ReadFromCommaSeparatedString()	874
10.244.3.5 SetOwner()	874
10.244.4 Friends And Related Function Documentation	874
10.244.4.1 operator<<	874
10.245 gdcM::ProgressEvent Class Reference	874
10.245.1 Detailed Description	875
10.245.2 Member Typedef Documentation	876
10.245.2.1 Self	876
10.245.2.2 Superclass	876
10.245.3 Constructor & Destructor Documentation	876
10.245.3.1 ProgressEvent() [1/2]	876

---

10.245.3.2	~ProcessEvent()	876
10.245.3.3	ProcessEvent() [2/2]	876
10.245.4	Member Function Documentation	876
10.245.4.1	CheckEvent()	877
10.245.4.2	GetEventName()	877
10.245.4.3	GetProgress()	877
10.245.4.4	MakeObject()	877
10.245.4.5	operator=()	877
10.245.4.6	SetProgress()	877
10.246	gdcM::PVRGCodec Class Reference	878
10.246.1	Detailed Description	879
10.246.2	Constructor & Destructor Documentation	879
10.246.2.1	PVRGCodec()	879
10.246.2.2	~PVRGCodec()	879
10.246.3	Member Function Documentation	879
10.246.3.1	CanCode()	880
10.246.3.2	CanDecode()	880
10.246.3.3	Clone()	880
10.246.3.4	Code()	880
10.246.3.5	Decode()	881
10.246.3.6	SetLossyFlag()	881
10.247	gdcM::PythonFilter Class Reference	881
10.247.1	Detailed Description	881
10.247.2	Constructor & Destructor Documentation	882
10.247.2.1	PythonFilter()	882
10.247.2.2	~PythonFilter()	882
10.247.3	Member Function Documentation	882
10.247.3.1	GetFile() [1/2]	882
10.247.3.2	GetFile() [2/2]	882
10.247.3.3	SetDicts()	882
10.247.3.4	SetFile()	882
10.247.3.5	ToPyObject()	883
10.247.3.6	UseDictAlways()	883
10.248	gdcM::QueryBase Class Reference	883
10.248.1	Detailed Description	884
10.248.2	Constructor & Destructor Documentation	884
10.248.2.1	~QueryBase()	884
10.248.3	Member Function Documentation	884
10.248.3.1	GetAllRequiredTags()	884

---

10.248.3.2 GetAllTags()	885
10.248.3.3 GetHierarchicalSearchTags()	885
10.248.3.4 GetName()	885
10.248.3.5 GetOptionalTags()	885
10.248.3.6 GetQueryLevel()	885
10.248.3.7 GetRequiredTags()	886
10.248.3.8 GetUniqueTags()	886
10.249 gdcM::QueryFactory Class Reference	886
10.249.1 Detailed Description	886
10.249.2 Member Function Documentation	887
10.249.2.1 GetCharacterFromCurrentLocale()	887
10.249.2.2 ListCharSets()	887
10.249.2.3 ProduceCharacterSetDataElement()	887
10.249.2.4 ProduceQuery() [1/2]	887
10.249.2.5 ProduceQuery() [2/2]	888
10.250 gdcM::QueryImage Class Reference	888
10.250.1 Detailed Description	889
10.250.2 Member Function Documentation	889
10.250.2.1 GetHierarchicalSearchTags()	889
10.250.2.2 GetName()	889
10.250.2.3 GetOptionalTags()	889
10.250.2.4 GetQueryLevel()	890
10.250.2.5 GetRequiredTags()	890
10.250.2.6 GetUniqueTags()	890
10.251 gdcM::QueryPatient Class Reference	890
10.251.1 Detailed Description	891
10.251.2 Member Function Documentation	891
10.251.2.1 GetHierarchicalSearchTags()	891
10.251.2.2 GetName()	892
10.251.2.3 GetOptionalTags()	892
10.251.2.4 GetQueryLevel()	892
10.251.2.5 GetRequiredTags()	892
10.251.2.6 GetUniqueTags()	892
10.252 gdcM::QuerySeries Class Reference	893
10.252.1 Detailed Description	894
10.252.2 Member Function Documentation	894
10.252.2.1 GetHierarchicalSearchTags()	894
10.252.2.2 GetName()	894
10.252.2.3 GetOptionalTags()	894

---

10.252.2.4	GetQueryLevel()	894
10.252.2.5	GetRequiredTags()	895
10.252.2.6	GetUniqueTags()	895
10.253	gdcM::QueryStudy Class Reference	895
10.253.1	Detailed Description	896
10.253.2	Member Function Documentation	896
10.253.2.1	GetHierarchicalSearchTags()	896
10.253.2.2	GetName()	897
10.253.2.3	GetOptionalTags()	897
10.253.2.4	GetQueryLevel()	897
10.253.2.5	GetRequiredTags()	897
10.253.2.6	GetUniqueTags()	897
10.254	gdcM::RAWCodec Class Reference	898
10.254.1	Detailed Description	899
10.254.2	Constructor & Destructor Documentation	899
10.254.2.1	RAWCodec()	899
10.254.2.2	~RAWCodec()	899
10.254.3	Member Function Documentation	899
10.254.3.1	CanCode()	900
10.254.3.2	CanDecode()	900
10.254.3.3	Clone()	900
10.254.3.4	Code()	900
10.254.3.5	Decode()	901
10.254.3.6	DecodeByStreams()	901
10.254.3.7	DecodeBytes()	901
10.254.3.8	GetHeaderInfo()	901
10.255	gdcM::Reader Class Reference	902
10.255.1	Detailed Description	904
10.255.2	Constructor & Destructor Documentation	905
10.255.2.1	Reader()	905
10.255.2.2	~Reader()	905
10.255.3	Member Function Documentation	905
10.255.3.1	CanRead()	905
10.255.3.2	GetFile() [1/2]	905
10.255.3.3	GetFile() [2/2]	906
10.255.3.4	GetStreamCurrentPosition()	906
10.255.3.5	GetStreamPtr()	906
10.255.3.6	Read()	906
10.255.3.7	ReadDataSet()	907

10.255.3.8	ReadMetaInformation()	907
10.255.3.9	ReadPreamble()	907
10.255.3.10	ReadSelectedPrivateTags()	907
10.255.3.11	ReadSelectedTags()	907
10.255.3.12	ReadUpToTag()	907
10.255.3.13	SetFile()	908
10.255.3.14	SetFileName()	908
10.255.3.15	SetStream()	909
10.255.4	Friends And Related Function Documentation	909
10.255.4.1	StreamImageReader	909
10.255.5	Member Data Documentation	909
10.255.5.1	F	909
10.256	gdcm::RealWorldValueMappingContent Struct Reference	910
10.256.1	Member Data Documentation	910
10.256.1.1	CodeMeaning	910
10.256.1.2	CodeValue	911
10.256.1.3	RealWorldValueIntercept	911
10.256.1.4	RealWorldValueSlope	911
10.257	gdcm::Region Class Reference	911
10.257.1	Detailed Description	912
10.257.2	Constructor & Destructor Documentation	912
10.257.2.1	Region()	912
10.257.2.2	~Region()	912
10.257.3	Member Function Documentation	912
10.257.3.1	Area()	913
10.257.3.2	Clone()	913
10.257.3.3	ComputeBoundingBox()	913
10.257.3.4	Empty()	913
10.257.3.5	IsValid()	913
10.257.3.6	Print()	914
10.258	gdcm::Rescaler Class Reference	914
10.258.1	Detailed Description	915
10.258.2	Constructor & Destructor Documentation	915
10.258.2.1	Rescaler()	916
10.258.2.2	~Rescaler()	916
10.258.3	Member Function Documentation	916
10.258.3.1	ComputeInterceptSlopePixelType()	916
10.258.3.2	ComputePixelTypeFromMinMax()	916
10.258.3.3	GetIntercept()	916



---

10.258.3.4	GetSlope()	916
10.258.3.5	InverseRescale()	917
10.258.3.6	InverseRescaleFunctionIntoBestFit()	917
10.258.3.7	Rescale()	917
10.258.3.8	RescaleFunctionIntoBestFit()	917
10.258.3.9	SetIntercept()	917
10.258.3.10	SetMinMaxForPixelType()	918
10.258.3.11	SetPixelFormat()	918
10.258.3.12	SetSlope()	918
10.258.3.13	SetTargetPixelType()	918
10.258.3.14	SetUseTargetPixelType()	918
10.259	gdcm::RLECodec Class Reference	919
10.259.1	Detailed Description	920
10.259.2	Constructor & Destructor Documentation	920
10.259.2.1	RLECodec()	921
10.259.2.2	~RLECodec()	921
10.259.3	Member Function Documentation	921
10.259.3.1	AppendFrameEncode()	921
10.259.3.2	AppendRowEncode()	921
10.259.3.3	CanCode()	921
10.259.3.4	CanDecode()	922
10.259.3.5	Clone()	922
10.259.3.6	Code()	922
10.259.3.7	Decode()	922
10.259.3.8	DecodeByStreams()	923
10.259.3.9	DecodeExtent()	923
10.259.3.10	GetBufferLength()	923
10.259.3.11	GetHeaderInfo()	923
10.259.3.12	IsFrameEncoder()	923
10.259.3.13	IsRowEncoder()	924
10.259.3.14	SetBufferLength()	924
10.259.3.15	SetLength()	924
10.259.3.16	StartEncode()	924
10.259.3.17	StopEncode()	924
10.259.4	Friends And Related Function Documentation	924
10.259.4.1	ImageRegionReader	925
10.260	gdcm::network::RoleSelectionSub Class Reference	925
10.260.1	Detailed Description	925
10.260.2	Constructor & Destructor Documentation	925

---

10.260.2.1 RoleSelectionSub()	925
10.260.3 Member Function Documentation	925
10.260.3.1 Print()	926
10.260.3.2 Read()	926
10.260.3.3 SetTuple()	926
10.260.3.4 Size()	926
10.260.3.5 Write()	926
10.261 gdcmm::Scanner Class Reference	927
10.261.1 Detailed Description	929
10.261.2 Member Typedef Documentation	929
10.261.2.1 ConstIterator	929
10.261.2.2 MappingType	930
10.261.2.3 TagToValue	930
10.261.2.4 TagToValueValueType	930
10.261.2.5 ValuesType	930
10.261.3 Constructor & Destructor Documentation	930
10.261.3.1 Scanner()	930
10.261.3.2 ~Scanner()	930
10.261.4 Member Function Documentation	930
10.261.4.1 AddPrivateTag()	931
10.261.4.2 AddSkipTag()	931
10.261.4.3 AddTag()	931
10.261.4.4 Begin()	931
10.261.4.5 ClearSkipTags()	931
10.261.4.6 ClearTags()	931
10.261.4.7 End()	932
10.261.4.8 GetAllFilenamesFromTagToValue()	932
10.261.4.9 GetFilenameFromTagToValue()	932
10.261.4.10 GetFilenames()	932
10.261.4.11 GetKeys()	932
10.261.4.12 GetMapping()	933
10.261.4.13 GetMappingFromTagToValue()	933
10.261.4.14 GetMappings()	933
10.261.4.15 GetOrderedValues()	933
10.261.4.16 GetValue()	933
10.261.4.17 GetValues() [1/2]	934
10.261.4.18 GetValues() [2/2]	934
10.261.4.19 IsKey()	934
10.261.4.20 New()	934

---

10.261.4.21 Print()	935
10.261.4.22 PrintTable()	935
10.261.4.23 ProcessPublicTag()	935
10.261.4.24 Scan()	935
10.261.5 Friends And Related Function Documentation	935
10.261.5.1 operator<<	936
10.262 gdcM::Segment Class Reference	936
10.262.1 Detailed Description	938
10.262.2 Member Typedef Documentation	938
10.262.2.1 BasicCodedEntryVector	938
10.262.2.2 SurfaceVector	938
10.262.3 Member Enumeration Documentation	938
10.262.3.1 ALGOType	938
10.262.4 Constructor & Destructor Documentation	939
10.262.4.1 Segment()	939
10.262.4.2 ~Segment()	939
10.262.5 Member Function Documentation	939
10.262.5.1 AddSurface()	939
10.262.5.2 GetALGOType()	939
10.262.5.3 GetALGOTypeString()	940
10.262.5.4 GetAnatomicRegion() [1/2]	940
10.262.5.5 GetAnatomicRegion() [2/2]	940
10.262.5.6 GetAnatomicRegionModifiers() [1/2]	940
10.262.5.7 GetAnatomicRegionModifiers() [2/2]	940
10.262.5.8 GetPropertyCategory() [1/2]	940
10.262.5.9 GetPropertyCategory() [2/2]	940
10.262.5.10 GetPropertyType() [1/2]	941
10.262.5.11 GetPropertyType() [2/2]	941
10.262.5.12 GetPropertyTypeModifiers() [1/2]	941
10.262.5.13 GetPropertyTypeModifiers() [2/2]	941
10.262.5.14 GetSegmentAlgorithmName()	941
10.262.5.15 GetSegmentAlgorithmType()	941
10.262.5.16 GetSegmentDescription()	941
10.262.5.17 GetSegmentLabel()	942
10.262.5.18 GetSegmentNumber()	942
10.262.5.19 GetSurface()	942
10.262.5.20 GetSurfaceCount()	942
10.262.5.21 GetSurfaces() [1/2]	942
10.262.5.22 GetSurfaces() [2/2]	942

---

10.262.5.23 SetAnatomicRegion()	942
10.262.5.24 SetAnatomicRegionModifiers()	943
10.262.5.25 SetPropertyCategory()	943
10.262.5.26 SetPropertyType()	943
10.262.5.27 SetPropertyTypeModifiers()	943
10.262.5.28 SetSegmentAlgorithmName()	943
10.262.5.29 SetSegmentAlgorithmType() [1/2]	943
10.262.5.30 SetSegmentAlgorithmType() [2/2]	944
10.262.5.31 SetSegmentDescription()	944
10.262.5.32 SetSegmentLabel()	944
10.262.5.33 SetSegmentNumber()	944
10.262.5.34 SetSurfaceCount()	944
10.262.6 Member Data Documentation	944
10.262.6.1 AnatomicRegion	944
10.262.6.2 AnatomicRegionModifiers	945
10.262.6.3 PropertyCategory	945
10.262.6.4 PropertyType	945
10.262.6.5 PropertyTypeModifiers	945
10.262.6.6 SegmentAlgorithmName	945
10.262.6.7 SegmentAlgorithmType	945
10.262.6.8 SegmentDescription	945
10.262.6.9 SegmentLabel	946
10.262.6.10 SegmentNumber	946
10.262.6.11 SurfaceCount	946
10.262.6.12 Surfaces	946
10.263 gdcm::SegmentedPaletteColorLookupTable Class Reference	946
10.263.1 Detailed Description	947
10.263.2 Constructor & Destructor Documentation	947
10.263.2.1 SegmentedPaletteColorLookupTable()	947
10.263.2.2 ~SegmentedPaletteColorLookupTable()	948
10.263.3 Member Function Documentation	948
10.263.3.1 Print()	948
10.263.3.2 SetLUT()	948
10.264 gdcm::SegmentReader Class Reference	949
10.264.1 Detailed Description	950
10.264.2 Member Typedef Documentation	950
10.264.2.1 SegmentMap	951
10.264.2.2 SegmentVector	951
10.264.3 Constructor & Destructor Documentation	951

---

10.264.3.1	SegmentReader()	951
10.264.3.2	~SegmentReader()	951
10.264.4	Member Function Documentation	951
10.264.4.1	GetSegments() [1/2]	951
10.264.4.2	GetSegments() [2/2]	951
10.264.4.3	Read()	952
10.264.4.4	ReadSegment()	952
10.264.4.5	ReadSegments()	952
10.264.5	Member Data Documentation	952
10.264.5.1	Segments	952
10.265	gdcM::SegmentWriter Class Reference	953
10.265.1	Detailed Description	954
10.265.2	Member Typedef Documentation	954
10.265.2.1	SegmentVector	954
10.265.3	Constructor & Destructor Documentation	954
10.265.3.1	SegmentWriter()	954
10.265.3.2	~SegmentWriter()	954
10.265.4	Member Function Documentation	955
10.265.4.1	AddSegment()	955
10.265.4.2	GetNumberOfSegments()	955
10.265.4.3	GetSegment()	955
10.265.4.4	GetSegments() [1/2]	955
10.265.4.5	GetSegments() [2/2]	955
10.265.4.6	PrepareWrite()	955
10.265.4.7	SetNumberOfSegments()	956
10.265.4.8	SetSegments()	956
10.265.4.9	Write()	956
10.265.5	Member Data Documentation	956
10.265.5.1	Segments	956
10.266	gdcM::SequenceOfFragments Class Reference	957
10.266.1	Detailed Description	958
10.266.2	Member Typedef Documentation	959
10.266.2.1	ConstIterator	959
10.266.2.2	FragmentVector	959
10.266.2.3	Iterator	959
10.266.2.4	SizeType	959
10.266.3	Constructor & Destructor Documentation	959
10.266.3.1	SequenceOfFragments()	959
10.266.4	Member Function Documentation	959

---

10.266.4.1 AddFragment()	960
10.266.4.2 Begin() [1/2]	960
10.266.4.3 Begin() [2/2]	960
10.266.4.4 Clear()	960
10.266.4.5 ComputeByteLength()	960
10.266.4.6 ComputeLength()	960
10.266.4.7 End() [1/2]	961
10.266.4.8 End() [2/2]	961
10.266.4.9 GetBuffer()	961
10.266.4.10 GetFragBuffer()	961
10.266.4.11 GetFragment()	961
10.266.4.12 GetLength()	962
10.266.4.13 GetNumberOfFragments()	962
10.266.4.14 GetTable() [1/2]	962
10.266.4.15 GetTable() [2/2]	962
10.266.4.16 New()	962
10.266.4.17 operator==( )	962
10.266.4.18 Print()	963
10.266.4.19 Read()	963
10.266.4.20 ReadPreValue()	963
10.266.4.21 ReadValue()	963
10.266.4.22 SetLength()	963
10.266.4.23 Write()	964
10.266.4.24 WriteBuffer()	964
10.267 gdcmm::SequenceOfItems Class Reference	964
10.267.1 Detailed Description	966
10.267.2 Member Typedef Documentation	967
10.267.2.1 ConstIterator	967
10.267.2.2 ItemVector	967
10.267.2.3 Iterator	967
10.267.2.4 SizeType	967
10.267.3 Constructor & Destructor Documentation	967
10.267.3.1 SequenceOfItems()	968
10.267.4 Member Function Documentation	968
10.267.4.1 AddItem()	968
10.267.4.2 AddNewUndefinedLengthItem()	968
10.267.4.3 Begin() [1/2]	968
10.267.4.4 Begin() [2/2]	968
10.267.4.5 Clear()	969

---

10.267.4.6 ComputeLength()	969
10.267.4.7 End() [1/2]	969
10.267.4.8 End() [2/2]	969
10.267.4.9 FindDataElement()	969
10.267.4.10 GetItem() [1/2]	969
10.267.4.11 GetItem() [2/2]	970
10.267.4.12 GetLength()	970
10.267.4.13 GetNumberOfItems()	970
10.267.4.14 IsEmpty()	970
10.267.4.15 IsUndefinedLength()	970
10.267.4.16 New()	971
10.267.4.17 operator=()	971
10.267.4.18 operator==(())	971
10.267.4.19 Print()	971
10.267.4.20 Read()	971
10.267.4.21 RemoveItemByIndex()	972
10.267.4.22 SetLength()	972
10.267.4.23 SetLengthToUndefined()	972
10.267.4.24 SetNumberOfItems()	972
10.267.4.25 Write()	972
10.267.5 Member Data Documentation	972
10.267.5.1 Items	973
10.267.5.2 SequenceLengthField	973
10.268 gdcM::SerieHelper Class Reference	973
10.268.1 Detailed Description	974
10.268.2 Member Typedef Documentation	975
10.268.2.1 Rule	975
10.268.2.2 SerieRestrictions	975
10.268.2.3 SingleSerieUIDFileSetmap	975
10.268.3 Constructor & Destructor Documentation	975
10.268.3.1 SerieHelper()	975
10.268.3.2 ~SerieHelper()	975
10.268.4 Member Function Documentation	975
10.268.4.1 AddFile()	976
10.268.4.2 AddFileName()	976
10.268.4.3 AddRestriction() [1/3]	976
10.268.4.4 AddRestriction() [2/3]	976
10.268.4.5 AddRestriction() [3/3]	976
10.268.4.6 Clear()	976

---

10.268.4.7 CreateDefaultUniqueSeriesIdentifier()	977
10.268.4.8 CreateUniqueSeriesIdentifier()	977
10.268.4.9 FileNameOrdering()	977
10.268.4.10 GetFirstSingleSerieUIDFileSet()	977
10.268.4.11 GetNextSingleSerieUIDFileSet()	977
10.268.4.12 ImageNumberOrdering()	977
10.268.4.13 ImagePositionPatientOrdering()	977
10.268.4.14 OrderFileList()	978
10.268.4.15 SetDirectory()	978
10.268.4.16 SetLoadMode()	978
10.268.4.17 SetUseSeriesDetails()	978
10.268.4.18 UserOrdering()	978
10.268.5 Member Data Documentation	978
10.268.5.1 elem	978
10.268.5.2 ItFileSetHt	979
10.268.5.3 op	979
10.268.5.4 SingleSerieUIDFileSetHT	979
10.268.5.5 value	979
10.269 gdcm::Series Class Reference	979
10.269.1 Detailed Description	979
10.269.2 Constructor & Destructor Documentation	980
10.269.2.1 Series()	980
10.270 gdcm::network::ServiceClassApplicationInformation Class Reference	980
10.270.1 Detailed Description	980
10.270.2 Constructor & Destructor Documentation	980
10.270.2.1 ServiceClassApplicationInformation()	980
10.270.3 Member Function Documentation	981
10.270.3.1 Print()	981
10.270.3.2 Read()	981
10.270.3.3 SetTuple()	981
10.270.3.4 Size()	981
10.270.3.5 Write()	981
10.271 gdcm::ServiceClassUser Class Reference	982
10.271.1 Detailed Description	984
10.271.2 Constructor & Destructor Documentation	984
10.271.2.1 ServiceClassUser() [1/2]	984
10.271.2.2 ~ServiceClassUser()	984
10.271.2.3 ServiceClassUser() [2/2]	984
10.271.3 Member Function Documentation	985



---

10.271.3.1 GetAETitle()	985
10.271.3.2 GetCalledAETitle()	985
10.271.3.3 GetTimeout()	985
10.271.3.4 InitializeConnection()	985
10.271.3.5 IsPresentationContextAccepted()	985
10.271.3.6 New()	986
10.271.3.7 operator=()	986
10.271.3.8 SendEcho()	986
10.271.3.9 SendFind()	986
10.271.3.10 SendMove() [1/3]	986
10.271.3.11 SendMove() [2/3]	987
10.271.3.12 SendMove() [3/3]	987
10.271.3.13 SendStore() [1/3]	987
10.271.3.14 SendStore() [2/3]	987
10.271.3.15 SendStore() [3/3]	987
10.271.3.16 SetAETitle()	988
10.271.3.17 SetCalledAETitle()	988
10.271.3.18 SetHostname()	988
10.271.3.19 SetPort()	988
10.271.3.20 SetPortSCP()	989
10.271.3.21 SetPresentationContexts()	989
10.271.3.22 SetTimeout()	989
10.271.3.23 StartAssociation()	989
10.271.3.24 StopAssociation()	990
10.272 gdcM::SHA1 Class Reference	990
10.272.1 Detailed Description	990
10.272.2 Constructor & Destructor Documentation	991
10.272.2.1 SHA1() [1/2]	991
10.272.2.2 ~SHA1()	991
10.272.2.3 SHA1() [2/2]	991
10.272.3 Member Function Documentation	991
10.272.3.1 Compute()	991
10.272.3.2 ComputeFile()	991
10.272.3.3 operator=()	992
10.273 gdcM::SimpleMemberCommand< T > Class Template Reference	992
10.273.1 Detailed Description	994
10.273.2 Member Typedef Documentation	994
10.273.2.1 Self	994
10.273.2.2 TMemberFunctionPointer	994

---

10.273.3 Constructor & Destructor Documentation	994
10.273.3.1 SimpleMemberCommand() [1/2]	994
10.273.3.2 SimpleMemberCommand() [2/2]	995
10.273.3.3 ~SimpleMemberCommand()	995
10.273.4 Member Function Documentation	995
10.273.4.1 Execute() [1/2]	995
10.273.4.2 Execute() [2/2]	995
10.273.4.3 New()	996
10.273.4.4 operator=()	996
10.273.4.5 SetCallbackFunction()	996
10.273.5 Member Data Documentation	996
10.273.5.1 m_MemberFunction	996
10.273.5.2 m_This	997
10.274 gdcm::SimpleSubjectWatcher Class Reference	997
10.274.1 Detailed Description	997
10.274.2 Constructor & Destructor Documentation	998
10.274.2.1 SimpleSubjectWatcher() [1/2]	998
10.274.2.2 ~SimpleSubjectWatcher()	998
10.274.2.3 SimpleSubjectWatcher() [2/2]	998
10.274.3 Member Function Documentation	998
10.274.3.1 EndFilter()	998
10.274.3.2 operator=()	998
10.274.3.3 ShowAbort()	999
10.274.3.4 ShowAnonymization()	999
10.274.3.5 ShowData()	999
10.274.3.6 ShowDataSet()	999
10.274.3.7 ShowFileName()	999
10.274.3.8 ShowIteration()	1000
10.274.3.9 ShowProgress()	1000
10.274.3.10 StartFilter()	1000
10.274.3.11 TestAbortOff()	1000
10.274.3.12 TestAbortOn()	1000
10.275 gdcm::MrProtocol::Slice Struct Reference	1001
10.275.1 Member Data Documentation	1001
10.275.1.1 Normal	1001
10.275.1.2 Position	1001
10.276 gdcm::MrProtocol::SliceArray Struct Reference	1002
10.276.1 Member Data Documentation	1002
10.276.1.1 Slices	1002

---

10.277 gdcM::SmartPointer< ObjectType > Class Template Reference . . . . .	1003
10.277.1 Detailed Description . . . . .	1004
10.277.2 Constructor & Destructor Documentation . . . . .	1004
10.277.2.1 SmartPointer() [1/4] . . . . .	1005
10.277.2.2 SmartPointer() [2/4] . . . . .	1005
10.277.2.3 SmartPointer() [3/4] . . . . .	1005
10.277.2.4 SmartPointer() [4/4] . . . . .	1005
10.277.2.5 ~SmartPointer() . . . . .	1005
10.277.3 Member Function Documentation . . . . .	1005
10.277.3.1 GetPointer() . . . . .	1006
10.277.3.2 operator ObjectType *() . . . . .	1006
10.277.3.3 operator*() . . . . .	1006
10.277.3.4 operator->() . . . . .	1006
10.277.3.5 operator=() [1/3] . . . . .	1006
10.277.3.6 operator=() [2/3] . . . . .	1007
10.277.3.7 operator=() [3/3] . . . . .	1007
10.278 gdcM::network::SOPClassExtendedNegociationSub Class Reference . . . . .	1007
10.278.1 Detailed Description . . . . .	1007
10.278.2 Constructor & Destructor Documentation . . . . .	1008
10.278.2.1 SOPClassExtendedNegociationSub() . . . . .	1008
10.278.3 Member Function Documentation . . . . .	1008
10.278.3.1 Print() . . . . .	1008
10.278.3.2 Read() . . . . .	1008
10.278.3.3 SetTuple() . . . . .	1008
10.278.3.4 Size() . . . . .	1008
10.278.3.5 Write() . . . . .	1009
10.279 gdcM::SOPClassUIDToIOD Class Reference . . . . .	1009
10.279.1 Detailed Description . . . . .	1009
10.279.2 Member Typedef Documentation . . . . .	1009
10.279.2.1 const . . . . .	1009
10.279.3 Member Function Documentation . . . . .	1010
10.279.3.1 GetIOD() . . . . .	1010
10.279.3.2 GetIODFromSOPClassUID() . . . . .	1010
10.279.3.3 GetNumberOfSOPClassToIOD() . . . . .	1010
10.279.3.4 GetSOPClassUIDFromIOD() . . . . .	1010
10.279.3.5 GetSOPClassUIDToIOD() . . . . .	1010
10.279.3.6 GetSOPClassUIDToIODs() . . . . .	1011
10.280 gdcM::Sorter Class Reference . . . . .	1011
10.280.1 Detailed Description . . . . .	1012

---

10.280.2 Member Typedef Documentation	1013
10.280.2.1 SelectionMap	1013
10.280.2.2 SortFunction	1013
10.280.3 Constructor & Destructor Documentation	1013
10.280.3.1 Sorter()	1013
10.280.3.2 ~Sorter()	1013
10.280.4 Member Function Documentation	1013
10.280.4.1 AddSelect()	1013
10.280.4.2 GetFileNames()	1014
10.280.4.3 Print()	1014
10.280.4.4 SetSortFunction()	1014
10.280.4.5 SetTagsToRead()	1014
10.280.4.6 Sort()	1015
10.280.4.7 StableSort()	1015
10.280.5 Friends And Related Function Documentation	1015
10.280.5.1 operator<<	1015
10.280.6 Member Data Documentation	1015
10.280.6.1 FileNames	1015
10.280.6.2 Selection	1016
10.280.6.3 SortFunc	1016
10.280.6.4 TagsToRead	1016
10.281 gdcM::Spacing Class Reference	1016
10.281.1 Detailed Description	1017
10.281.2 Member Enumeration Documentation	1017
10.281.2.1 SpacingType	1017
10.281.3 Constructor & Destructor Documentation	1018
10.281.3.1 Spacing()	1018
10.281.3.2 ~Spacing()	1018
10.281.4 Member Function Documentation	1018
10.281.4.1 ComputePixelAspectRatioFromPixelSpacing()	1018
10.282 gdcM::Spectroscopy Class Reference	1018
10.282.1 Detailed Description	1019
10.282.2 Constructor & Destructor Documentation	1019
10.282.2.1 Spectroscopy()	1019
10.283 gdcM::SplitMosaicFilter Class Reference	1019
10.283.1 Detailed Description	1020
10.283.2 Constructor & Destructor Documentation	1020
10.283.2.1 SplitMosaicFilter()	1020
10.283.2.2 ~SplitMosaicFilter()	1020

---

10.283.3 Member Function Documentation	1020
10.283.3.1 ComputeMOSAICDimensions()	1020
10.283.3.2 ComputeMOSAICSliceNormal()	1021
10.283.3.3 ComputeMOSAICSlicePosition()	1021
10.283.3.4 GetAcquisitionSize()	1021
10.283.3.5 GetFile() [1/2]	1021
10.283.3.6 GetFile() [2/2]	1021
10.283.3.7 GetImage() [1/2]	1021
10.283.3.8 GetImage() [2/2]	1022
10.283.3.9 GetNumberOfImagesInMosaic()	1022
10.283.3.10 SetFile()	1022
10.283.3.11 SetImage()	1022
10.283.3.12 Split()	1022
10.284 gdcM::StartEvent Class Reference	1023
10.285 gdcM::static_assert_test< x > Struct Template Reference	1024
10.286 gdcM::STATIC_ASSERTION_FAILURE< x > Struct Template Reference	1024
10.287 gdcM::STATIC_ASSERTION_FAILURE< true > Struct Reference	1024
10.287.1 Member Enumeration Documentation	1024
10.287.1.1 anonymous enum	1024
10.288 gdcM::StreamImageReader Class Reference	1025
10.288.1 Detailed Description	1025
10.288.2 Constructor & Destructor Documentation	1025
10.288.2.1 StreamImageReader()	1026
10.288.2.2 ~StreamImageReader()	1026
10.288.3 Member Function Documentation	1026
10.288.3.1 CanReadImage()	1026
10.288.3.2 DefinePixelExtent()	1026
10.288.3.3 DefineProperBufferLength()	1027
10.288.3.4 GetDimensionsValueForResolution()	1027
10.288.3.5 GetFile()	1027
10.288.3.6 Read()	1027
10.288.3.7 ReadImageInformation()	1028
10.288.3.8 SetFileName()	1028
10.288.3.9 SetStream()	1028
10.289 gdcM::StreamImageWriter Class Reference	1029
10.289.1 Detailed Description	1030
10.289.2 Constructor & Destructor Documentation	1031
10.289.2.1 StreamImageWriter()	1031
10.289.2.2 ~StreamImageWriter()	1031

---

10.289.3 Member Function Documentation	1031
10.289.3.1 CanWriteFile()	1031
10.289.3.2 DefinePixelExtent()	1031
10.289.3.3 DefineProperBufferLength()	1032
10.289.3.4 SetFile()	1032
10.289.3.5 SetFileName()	1032
10.289.3.6 SetStream()	1032
10.289.3.7 Write()	1033
10.289.3.8 WriteImageInformation()	1033
10.289.3.9 WriteImageSubregionRAW()	1033
10.289.3.10 WriteRawHeader()	1034
10.289.4 Member Data Documentation	1034
10.289.4.1 mElementOffsets	1034
10.289.4.2 mElementOffsets1	1034
10.289.4.3 mspFile	1034
10.289.4.4 mWriter	1034
10.289.4.5 mXMax	1035
10.289.4.6 mXMin	1035
10.289.4.7 mYMax	1035
10.289.4.8 mYMin	1035
10.289.4.9 mZMax	1035
10.289.4.10 mZMin	1035
10.290 gdcM::StrictScanner Class Reference	1036
10.290.1 Detailed Description	1038
10.290.2 Member Typedef Documentation	1038
10.290.2.1 ConstIterator	1038
10.290.2.2 MappingType	1039
10.290.2.3 TagToValue	1039
10.290.2.4 TagToValueValueType	1039
10.290.2.5 ValuesType	1039
10.290.3 Constructor & Destructor Documentation	1039
10.290.3.1 StrictScanner()	1039
10.290.3.2 ~StrictScanner()	1039
10.290.4 Member Function Documentation	1039
10.290.4.1 AddPrivateTag()	1040
10.290.4.2 AddSkipTag()	1040
10.290.4.3 AddTag()	1040
10.290.4.4 Begin()	1040
10.290.4.5 ClearSkipTags()	1040

---

10.290.4.6 ClearTags()	1040
10.290.4.7 End()	1041
10.290.4.8 GetAllFileNamesFromTagToValue()	1041
10.290.4.9 GetFilenameFromTagToValue()	1041
10.290.4.10 GetFileNames()	1041
10.290.4.11 GetKeys()	1041
10.290.4.12 GetMapping()	1041
10.290.4.13 GetMappingFromTagToValue()	1042
10.290.4.14 GetMappings()	1042
10.290.4.15 GetOrderedValues()	1042
10.290.4.16 GetValue()	1042
10.290.4.17 GetValues() [1/2]	1042
10.290.4.18 GetValues() [2/2]	1043
10.290.4.19 IsKey()	1043
10.290.4.20 New()	1043
10.290.4.21 Print()	1043
10.290.4.22 PrintTable()	1043
10.290.4.23 ProcessPublicTag()	1044
10.290.4.24 Scan()	1044
10.290.5 Friends And Related Function Documentation	1044
10.290.5.1 operator<<	1044
10.291 gdcM::String< TDelimiter, TMaxLength, TPadChar > Class Template Reference	1045
10.291.1 Detailed Description	1046
10.291.2 Member Typedef Documentation	1047
10.291.2.1 const_iterator	1047
10.291.2.2 const_reference	1047
10.291.2.3 const_reverse_iterator	1047
10.291.2.4 difference_type	1047
10.291.2.5 iterator	1047
10.291.2.6 pointer	1048
10.291.2.7 reference	1048
10.291.2.8 reverse_iterator	1048
10.291.2.9 size_type	1048
10.291.2.10 value_type	1048
10.291.3 Constructor & Destructor Documentation	1048
10.291.3.1 String() [1/4]	1048
10.291.3.2 String() [2/4]	1049
10.291.3.3 String() [3/4]	1049
10.291.3.4 String() [4/4]	1049

---

10.291.4 Member Function Documentation	1049
10.291.4.1 IsValid()	1049
10.291.4.2 operator const char *()	1049
10.291.4.3 Trim() [1/2]	1050
10.291.4.4 Trim() [2/2]	1050
10.291.4.5 Truncate()	1050
10.292 gdcM::StringFilter Class Reference	1050
10.292.1 Detailed Description	1051
10.292.2 Constructor & Destructor Documentation	1051
10.292.2.1 StringFilter()	1051
10.292.2.2 ~StringFilter()	1052
10.292.3 Member Function Documentation	1052
10.292.3.1 ExecuteQuery() [1/2]	1052
10.292.3.2 ExecuteQuery() [2/2]	1052
10.292.3.3 FromString()	1052
10.292.3.4 GetFile() [1/2]	1052
10.292.3.5 GetFile() [2/2]	1053
10.292.3.6 SetDicts()	1053
10.292.3.7 SetFile()	1053
10.292.3.8 ToString() [1/3]	1053
10.292.3.9 ToString() [2/3]	1053
10.292.3.10 ToString() [3/3]	1054
10.292.3.11 ToStringPair() [1/3]	1054
10.292.3.12 ToStringPair() [2/3]	1054
10.292.3.13 ToStringPair() [3/3]	1054
10.292.3.14 UseDictAlways()	1054
10.293 gdcM::Study Class Reference	1055
10.293.1 Detailed Description	1055
10.293.2 Constructor & Destructor Documentation	1055
10.293.2.1 Study()	1055
10.294 gdcM::Subject Class Reference	1055
10.294.1 Detailed Description	1057
10.294.2 Constructor & Destructor Documentation	1057
10.294.2.1 Subject()	1057
10.294.2.2 ~Subject()	1057
10.294.3 Member Function Documentation	1057
10.294.3.1 AddObserver() [1/2]	1057
10.294.3.2 AddObserver() [2/2]	1058
10.294.3.3 GetCommand()	1058



---

10.294.3.4 HasObserver()	1058
10.294.3.5 InvokeEvent() [1/2]	1058
10.294.3.6 InvokeEvent() [2/2]	1058
10.294.3.7 RemoveAllObservers()	1058
10.294.3.8 RemoveObserver()	1059
10.295 gdcmm::Surface Class Reference	1059
10.295.1 Detailed Description	1061
10.295.2 Member Enumeration Documentation	1062
10.295.2.1 STATES	1062
10.295.2.2 VIEWType	1062
10.295.3 Constructor & Destructor Documentation	1062
10.295.3.1 Surface()	1062
10.295.3.2 ~Surface()	1063
10.295.4 Member Function Documentation	1063
10.295.4.1 GetAlgorithmFamily() [1/2]	1063
10.295.4.2 GetAlgorithmFamily() [2/2]	1063
10.295.4.3 GetAlgorithmName()	1063
10.295.4.4 GetAlgorithmVersion()	1063
10.295.4.5 GetAxisOfRotation()	1063
10.295.4.6 GetCenterOfRotation()	1064
10.295.4.7 GetFiniteVolume()	1064
10.295.4.8 GetManifold()	1064
10.295.4.9 GetMaximumPointDistance()	1064
10.295.4.10 GetMeanPointDistance()	1064
10.295.4.11 GetMeshPrimitive() [1/2]	1064
10.295.4.12 GetMeshPrimitive() [2/2]	1065
10.295.4.13 GetNumberOfSurfacePoints()	1065
10.295.4.14 GetNumberOfVectors()	1065
10.295.4.15 GetPointCoordinatesData() [1/2]	1065
10.295.4.16 GetPointCoordinatesData() [2/2]	1065
10.295.4.17 GetPointPositionAccuracy()	1065
10.295.4.18 GetPointsBoundingBoxCoordinates()	1066
10.295.4.19 GetProcessingAlgorithm() [1/2]	1066
10.295.4.20 GetProcessingAlgorithm() [2/2]	1066
10.295.4.21 GetRecommendedDisplayCIELabValue() [1/2]	1066
10.295.4.22 GetRecommendedDisplayCIELabValue() [2/2]	1066
10.295.4.23 GetRecommendedDisplayGrayscaleValue()	1066
10.295.4.24 GetRecommendedPresentationOpacity()	1067
10.295.4.25 GetRecommendedPresentationType()	1067

---

10.295.4.26 GetSTATES()	1067
10.295.4.27 GetSTATESString()	1067
10.295.4.28 GetSurfaceComments()	1067
10.295.4.29 GetSurfaceNumber()	1067
10.295.4.30 GetSurfaceProcessing()	1067
10.295.4.31 GetSurfaceProcessingDescription()	1068
10.295.4.32 GetSurfaceProcessingRatio()	1068
10.295.4.33 GetVectorAccuracy()	1068
10.295.4.34 GetVectorCoordinateData() [1/2]	1068
10.295.4.35 GetVectorCoordinateData() [2/2]	1068
10.295.4.36 GetVectorDimensionality()	1068
10.295.4.37 GetVIEWType()	1068
10.295.4.38 GetVIEWTypeString()	1069
10.295.4.39 SetAlgorithmFamily()	1069
10.295.4.40 SetAlgorithmName()	1069
10.295.4.41 SetAlgorithmVersion()	1069
10.295.4.42 SetAxisOfRotation()	1069
10.295.4.43 SetCenterOfRotation()	1069
10.295.4.44 SetFiniteVolume()	1070
10.295.4.45 SetManifold()	1070
10.295.4.46 SetMaximumPointDistance()	1070
10.295.4.47 SetMeanPointDistance()	1070
10.295.4.48 SetMeshPrimitive()	1070
10.295.4.49 SetNumberOfSurfacePoints()	1070
10.295.4.50 SetNumberOfVectors()	1071
10.295.4.51 SetPointCoordinatesData()	1071
10.295.4.52 SetPointPositionAccuracy()	1071
10.295.4.53 SetPointsBoundingBoxCoordinates()	1071
10.295.4.54 SetProcessingAlgorithm()	1071
10.295.4.55 SetRecommendedDisplayCIELabValue() [1/3]	1071
10.295.4.56 SetRecommendedDisplayCIELabValue() [2/3]	1072
10.295.4.57 SetRecommendedDisplayCIELabValue() [3/3]	1072
10.295.4.58 SetRecommendedDisplayGrayscaleValue()	1072
10.295.4.59 SetRecommendedPresentationOpacity()	1072
10.295.4.60 SetRecommendedPresentationType()	1072
10.295.4.61 SetSurfaceComments()	1072
10.295.4.62 SetSurfaceNumber()	1073
10.295.4.63 SetSurfaceProcessing()	1073
10.295.4.64 SetSurfaceProcessingDescription()	1073

---

10.295.4.65 SetSurfaceProcessingRatio()	1073
10.295.4.66 SetVectorAccuracy()	1073
10.295.4.67 SetVectorCoordinateData()	1073
10.295.4.68 SetVectorDimensionality()	1074
10.296 gdcM::SurfaceHelper Class Reference	1074
10.296.1 Detailed Description	1074
10.296.2 Member Typedef Documentation	1075
10.296.2.1 ColorArray	1075
10.296.3 Member Function Documentation	1075
10.296.3.1 RecommendedDisplayCIELabToRGB() [1/2]	1075
10.296.3.2 RecommendedDisplayCIELabToRGB() [2/2]	1075
10.296.3.3 RGBToRecommendedDisplayCIELab()	1076
10.296.3.4 RGBToRecommendedDisplayGrayscale()	1077
10.297 gdcM::SurfaceReader Class Reference	1077
10.297.1 Detailed Description	1079
10.297.2 Constructor & Destructor Documentation	1079
10.297.2.1 SurfaceReader()	1079
10.297.2.2 ~SurfaceReader()	1079
10.297.3 Member Function Documentation	1079
10.297.3.1 GetNumberOfSurfaces()	1080
10.297.3.2 Read()	1080
10.297.3.3 ReadPointMacro()	1080
10.297.3.4 ReadSurface()	1080
10.297.3.5 ReadSurfaces()	1080
10.298 gdcM::SurfaceWriter Class Reference	1081
10.298.1 Detailed Description	1082
10.298.2 Constructor & Destructor Documentation	1082
10.298.2.1 SurfaceWriter()	1082
10.298.2.2 ~SurfaceWriter()	1082
10.298.3 Member Function Documentation	1082
10.298.3.1 ComputeNumberOfSurfaces()	1082
10.298.3.2 GetNumberOfSurfaces()	1083
10.298.3.3 PrepareWrite()	1083
10.298.3.4 PrepareWritePointMacro()	1083
10.298.3.5 SetNumberOfSurfaces()	1083
10.298.3.6 Write()	1083
10.298.4 Member Data Documentation	1083
10.298.4.1 NumberOfSurfaces	1084
10.299 gdcM::SwapCode Class Reference	1084

10.299.1 Detailed Description . . . . .	1085
10.299.2 Member Enumeration Documentation . . . . .	1085
10.299.2.1 SwapCodeType . . . . .	1085
10.299.3 Constructor & Destructor Documentation . . . . .	1085
10.299.3.1 SwapCode() . . . . .	1085
10.299.4 Member Function Documentation . . . . .	1085
10.299.4.1 GetIndex() . . . . .	1085
10.299.4.2 GetSwapCodeString() . . . . .	1086
10.299.4.3 operator SwapCode::SwapCodeType() . . . . .	1086
10.299.5 Friends And Related Function Documentation . . . . .	1086
10.299.5.1 operator<< . . . . .	1086
10.300 gdcM::SwapperDoOp Class Reference . . . . .	1086
10.300.1 Member Function Documentation . . . . .	1086
10.300.1.1 Swap() . . . . .	1087
10.300.1.2 SwapArray() . . . . .	1087
10.301 gdcM::SwapperNoOp Class Reference . . . . .	1087
10.301.1 Detailed Description . . . . .	1087
10.301.2 Member Function Documentation . . . . .	1087
10.301.2.1 Swap() . . . . .	1088
10.301.2.2 SwapArray() . . . . .	1088
10.302 gdcM::System Class Reference . . . . .	1088
10.302.1 Detailed Description . . . . .	1089
10.302.2 Member Function Documentation . . . . .	1089
10.302.2.1 ConvertToUNC() . . . . .	1089
10.302.2.2 DeleteDirectory() . . . . .	1090
10.302.2.3 EncodeBytes() . . . . .	1090
10.302.2.4 FileExists() . . . . .	1090
10.302.2.5 FileIsDirectory() . . . . .	1090
10.302.2.6 FileIsSymlink() . . . . .	1091
10.302.2.7 FileSize() . . . . .	1091
10.302.2.8 FileTime() . . . . .	1091
10.302.2.9 FormatDateTime() . . . . .	1091
10.302.2.10 GetCurrentDateTime() . . . . .	1092
10.302.2.11 GetCurrentModuleFileName() . . . . .	1092
10.302.2.12 GetCurrentProcessFileName() . . . . .	1092
10.302.2.13 GetCurrentResourcesDirectory() . . . . .	1092
10.302.2.14 GetCWD() . . . . .	1092
10.302.2.15 GetHostName() . . . . .	1092
10.302.2.16 GetLastSystemError() . . . . .	1093

---

10.302.2.17 GetLocaleCharset()	1093
10.302.2.18 GetPermissions()	1093
10.302.2.19 GetTimezoneOffsetFromUTC()	1093
10.302.2.20 MakeDirectory()	1093
10.302.2.21 ParseDateTime() [1/2]	1094
10.302.2.22 ParseDateTime() [2/2]	1094
10.302.2.23 RemoveFile()	1094
10.302.2.24 SetPermissions()	1094
10.302.2.25 StrCaseCmp()	1095
10.302.2.26 StrNCaseCmp()	1095
10.302.2.27 StrSep()	1095
10.302.2.28 StrTokR()	1095
10.303 gdcM::Table Class Reference	1096
10.303.1 Detailed Description	1097
10.303.2 Member Typedef Documentation	1097
10.303.2.1 MapTableEntry	1097
10.303.3 Constructor & Destructor Documentation	1097
10.303.3.1 Table() [1/2]	1097
10.303.3.2 ~Table()	1097
10.303.3.3 Table() [2/2]	1097
10.303.4 Member Function Documentation	1097
10.303.4.1 GetTableEntry()	1098
10.303.4.2 InsertEntry()	1098
10.303.4.3 operator=()	1098
10.303.5 Friends And Related Function Documentation	1098
10.303.5.1 operator<<	1098
10.303.6 Member Data Documentation	1098
10.303.6.1 TableInternal	1098
10.304 gdcM::TableEntry Class Reference	1099
10.304.1 Detailed Description	1099
10.304.2 Constructor & Destructor Documentation	1099
10.304.2.1 TableEntry()	1099
10.304.2.2 ~TableEntry()	1099
10.305 gdcM::TableReader Class Reference	1100
10.305.1 Detailed Description	1100
10.305.2 Constructor & Destructor Documentation	1101
10.305.2.1 TableReader()	1101
10.305.2.2 ~TableReader()	1101
10.305.3 Member Function Documentation	1101

---

10.305.3.1 CharacterDataHandler()	1101
10.305.3.2 EndElement()	1101
10.305.3.3 GetDefs()	1101
10.305.3.4 GetFilename()	1102
10.305.3.5 HandleIOD()	1102
10.305.3.6 HandleIOEntry()	1102
10.305.3.7 HandleMacro()	1102
10.305.3.8 HandleMacroEntry()	1102
10.305.3.9 HandleMacroEntryDescription()	1102
10.305.3.10 HandleModule()	1103
10.305.3.11 HandleModuleEntry()	1103
10.305.3.12 HandleModuleEntryDescription()	1103
10.305.3.13 HandleModuleInclude()	1103
10.305.3.14 Read()	1103
10.305.3.15 SetFilename()	1103
10.305.3.16 StartElement()	1104
10.306 gdcM::network::TableRow Class Reference	1104
10.306.1 Constructor & Destructor Documentation	1105
10.306.1.1 TableRow()	1105
10.306.1.2 ~TableRow()	1105
10.306.2 Member Data Documentation	1105
10.306.2.1 transitions	1105
10.307 gdcM::Tag Class Reference	1105
10.307.1 Detailed Description	1107
10.307.2 Constructor & Destructor Documentation	1107
10.307.2.1 Tag() [1/3]	1108
10.307.2.2 Tag() [2/3]	1108
10.307.2.3 Tag() [3/3]	1108
10.307.3 Member Function Documentation	1108
10.307.3.1 GetElement()	1108
10.307.3.2 GetElementTag()	1109
10.307.3.3 GetGroup()	1109
10.307.3.4 GetLength()	1109
10.307.3.5 GetPrivateCreator()	1109
10.307.3.6 IsGroupLength()	1109
10.307.3.7 IsGroupXX()	1110
10.307.3.8 IsIllegal()	1110
10.307.3.9 IsPrivate()	1110
10.307.3.10 IsPrivateCreator()	1110

---

10.307.3.11 IsPublic()	1111
10.307.3.12 operator!=(())	1111
10.307.3.13 operator<()	1111
10.307.3.14 operator<=()	1111
10.307.3.15 operator=()	1111
10.307.3.16 operator==(())	1112
10.307.3.17 operator[]() [1/2]	1112
10.307.3.18 operator[]() [2/2]	1112
10.307.3.19 PrintAsContinuousString()	1112
10.307.3.20 PrintAsContinuousUpperCaseString()	1112
10.307.3.21 PrintAsPipeSeparatedString()	1113
10.307.3.22 Read()	1113
10.307.3.23 ReadFromCommaSeparatedString()	1113
10.307.3.24 ReadFromContinuousString()	1113
10.307.3.25 ReadFromPipeSeparatedString()	1113
10.307.3.26 SetElement()	1114
10.307.3.27 SetElementTag() [1/2]	1114
10.307.3.28 SetElementTag() [2/2]	1114
10.307.3.29 SetGroup()	1114
10.307.3.30 SetPrivateCreator()	1115
10.307.3.31 Write()	1115
10.307.4 Friends And Related Function Documentation	1115
10.307.4.1 operator<<	1115
10.307.4.2 operator>>	1115
10.307.5 Member Data Documentation	1116
10.307.5.1 bytes	1116
10.307.5.2 tag	1116
10.307.5.3 tags	1116
10.308 gdcmm::TagPath Class Reference	1116
10.308.1 Detailed Description	1117
10.308.2 Constructor & Destructor Documentation	1117
10.308.2.1 TagPath()	1117
10.308.2.2 ~TagPath()	1117
10.308.3 Member Function Documentation	1117
10.308.3.1 ConstructFromString()	1117
10.308.3.2 ConstructFromTagList()	1118
10.308.3.3 IsValid()	1118
10.308.3.4 Print()	1118
10.308.3.5 Push() [1/2]	1118

---

10.308.3.6 Push() [2/2]	1118
10.309 gdcM::Testing Class Reference	1119
10.309.1 Detailed Description	1120
10.309.2 Member Typedef Documentation	1120
10.309.2.1 MD5DataImagesType	1120
10.309.2.2 MediaStorageDataFilesType	1120
10.309.3 Constructor & Destructor Documentation	1120
10.309.3.1 Testing()	1120
10.309.3.2 ~Testing()	1121
10.309.4 Member Function Documentation	1121
10.309.4.1 ComputeFileMD5()	1121
10.309.4.2 ComputeMD5()	1121
10.309.4.3 GetDataExtraRoot()	1121
10.309.4.4 GetDataRoot()	1122
10.309.4.5 GetFileName()	1122
10.309.4.6 GetFileNames()	1122
10.309.4.7 GetLossyFlagFromFile()	1122
10.309.4.8 GetMD5DataImage()	1123
10.309.4.9 GetMD5DataImages()	1123
10.309.4.10 GetMD5FromBrokenFile()	1123
10.309.4.11 GetMD5FromFile()	1123
10.309.4.12 GetMediaStorageDataFile()	1123
10.309.4.13 GetMediaStorageDataFiles()	1123
10.309.4.14 GetMediaStorageFromFile()	1124
10.309.4.15 GetNumberOfFileNames()	1124
10.309.4.16 GetNumberOfMD5DataImages()	1124
10.309.4.17 GetNumberOfMediaStorageDataFiles()	1124
10.309.4.18 GetPixelSpacingDataRoot()	1124
10.309.4.19 GetSelectedPrivateGroupOffsetFromFile()	1125
10.309.4.20 GetSelectedTagsOffsetFromFile()	1125
10.309.4.21 GetSourceDirectory()	1125
10.309.4.22 GetStreamOffsetFromFile()	1125
10.309.4.23 GetTempDirectory()	1125
10.309.4.24 GetTempDirectoryW()	1126
10.309.4.25 GetTempFilename()	1126
10.309.4.26 GetTempFilenameW()	1126
10.309.4.27 Print()	1126
10.310 gdcM::Trace Class Reference	1127
10.310.1 Detailed Description	1128



---

10.310.2 Constructor & Destructor Documentation . . . . .	1128
10.310.2.1 Trace() . . . . .	1128
10.310.2.2 ~Trace() . . . . .	1128
10.310.3 Member Function Documentation . . . . .	1128
10.310.3.1 DebugOff() . . . . .	1128
10.310.3.2 DebugOn() . . . . .	1129
10.310.3.3 ErrorOff() . . . . .	1129
10.310.3.4 ErrorOn() . . . . .	1129
10.310.3.5 GetDebugFlag() . . . . .	1129
10.310.3.6 GetDebugStream() . . . . .	1129
10.310.3.7 GetErrorFlag() . . . . .	1129
10.310.3.8 GetErrorStream() . . . . .	1130
10.310.3.9 GetStream() . . . . .	1130
10.310.3.10 GetWarningFlag() . . . . .	1130
10.310.3.11 GetWarningStream() . . . . .	1130
10.310.3.12 SetDebug() . . . . .	1130
10.310.3.13 SetDebugStream() . . . . .	1130
10.310.3.14 SetError() . . . . .	1131
10.310.3.15 SetErrorStream() . . . . .	1131
10.310.3.16 SetStream() . . . . .	1131
10.310.3.17 SetStreamToFile() . . . . .	1131
10.310.3.18 SetWarning() . . . . .	1131
10.310.3.19 SetWarningStream() . . . . .	1132
10.310.3.20 WarningOff() . . . . .	1132
10.310.3.21 WarningOn() . . . . .	1132
10.311 gdcmm::TransferSyntax Class Reference . . . . .	1132
10.311.1 Detailed Description . . . . .	1134
10.311.2 Member Enumeration Documentation . . . . .	1134
10.311.2.1 NegotiatedType . . . . .	1134
10.311.2.2 TSType . . . . .	1135
10.311.3 Constructor & Destructor Documentation . . . . .	1135
10.311.3.1 TransferSyntax() . . . . .	1136
10.311.4 Member Function Documentation . . . . .	1136
10.311.4.1 CanStoreLossy() . . . . .	1136
10.311.4.2 GetNegotiatedType() . . . . .	1136
10.311.4.3 GetString() . . . . .	1136
10.311.4.4 GetSwapCode() . . . . .	1136
10.311.4.5 GetTSString() . . . . .	1137
10.311.4.6 GetTSType() . . . . .	1137

---

10.311.4.7 IsEncapsulated()	1137
10.311.4.8 IsEncoded()	1137
10.311.4.9 IsExplicit()	1137
10.311.4.10 IsImplicit()	1138
10.311.4.11 IsLossless()	1138
10.311.4.12 IsLossy()	1138
10.311.4.13 IsValid()	1138
10.311.4.14 operator TSType()	1138
10.311.5 Friends And Related Function Documentation	1138
10.311.5.1 operator<<	1138
10.312 gdcM::network::TransferSyntaxSub Class Reference	1139
10.312.1 Detailed Description	1139
10.312.2 Constructor & Destructor Documentation	1139
10.312.2.1 TransferSyntaxSub()	1139
10.312.3 Member Function Documentation	1139
10.312.3.1 GetName()	1140
10.312.3.2 operator==(())	1140
10.312.3.3 Print()	1140
10.312.3.4 Read()	1140
10.312.3.5 SetName()	1140
10.312.3.6 SetNameFromUID()	1140
10.312.3.7 Size()	1141
10.312.3.8 Write()	1141
10.313 gdcM::network::Transition Struct Reference	1141
10.313.1 Constructor & Destructor Documentation	1142
10.313.1.1 Transition() [1/2]	1142
10.313.1.2 ~Transition()	1142
10.313.1.3 Transition() [2/2]	1142
10.313.2 Member Function Documentation	1142
10.313.2.1 MakeNew()	1142
10.313.3 Member Data Documentation	1143
10.313.3.1 mAction	1143
10.313.3.2 mEnd	1143
10.314 gdcM::Type Class Reference	1143
10.314.1 Detailed Description	1144
10.314.2 Member Enumeration Documentation	1144
10.314.2.1 TypeType	1144
10.314.3 Constructor & Destructor Documentation	1144
10.314.3.1 Type()	1145

---

10.314.4 Member Function Documentation	1145
10.314.4.1 GetTypeString()	1145
10.314.4.2 GetTypeType()	1145
10.314.4.3 operator TypeType()	1145
10.314.5 Friends And Related Function Documentation	1145
10.314.5.1 operator<<	1145
10.315 gdcM::UI Struct Reference	1146
10.315.1 Friends And Related Function Documentation	1146
10.315.1.1 operator<<	1146
10.315.2 Member Data Documentation	1146
10.315.2.1 Internal	1146
10.316 gdcM::UIDGenerator Class Reference	1146
10.316.1 Detailed Description	1147
10.316.2 Constructor & Destructor Documentation	1147
10.316.2.1 UIDGenerator()	1147
10.316.3 Member Function Documentation	1148
10.316.3.1 Generate()	1148
10.316.3.2 GenerateUUID()	1148
10.316.3.3 GetGDCMUID()	1148
10.316.3.4 GetRoot()	1148
10.316.3.5 IsValid()	1149
10.316.3.6 SetRoot()	1149
10.317 gdcM::UIDs Class Reference	1149
10.317.1 Detailed Description	1165
10.317.2 Member Typedef Documentation	1165
10.317.2.1 TransferSyntaxStringsType	1165
10.317.3 Member Enumeration Documentation	1166
10.317.3.1 TSName	1166
10.317.3.2 TSType	1175
10.317.4 Member Function Documentation	1185
10.317.4.1 GetName()	1185
10.317.4.2 GetNumberOfTransferSyntaxStrings()	1185
10.317.4.3 GetString()	1185
10.317.4.4 GetTransferSyntaxString()	1185
10.317.4.5 GetTransferSyntaxStrings()	1186
10.317.4.6 GetUIDName()	1186
10.317.4.7 GetUIDString()	1186
10.317.4.8 operator TSType()	1186
10.317.4.9 SetFromUID()	1186

---

10.318 gdcmm::network::ULAction Class Reference . . . . .	1187
10.318.1 Detailed Description . . . . .	1188
10.318.2 Constructor & Destructor Documentation . . . . .	1188
10.318.2.1 UAction() [1/2] . . . . .	1188
10.318.2.2 ~UAction() . . . . .	1189
10.318.2.3 UAction() [2/2] . . . . .	1189
10.318.3 Member Function Documentation . . . . .	1189
10.318.3.1 operator=() . . . . .	1189
10.318.3.2 PerformAction() . . . . .	1189
10.319 gdcmm::network::ULActionAA1 Class Reference . . . . .	1190
10.319.1 Member Function Documentation . . . . .	1190
10.319.1.1 PerformAction() . . . . .	1191
10.320 gdcmm::network::ULActionAA2 Class Reference . . . . .	1191
10.320.1 Member Function Documentation . . . . .	1192
10.320.1.1 PerformAction() . . . . .	1192
10.321 gdcmm::network::ULActionAA3 Class Reference . . . . .	1192
10.321.1 Member Function Documentation . . . . .	1193
10.321.1.1 PerformAction() . . . . .	1193
10.322 gdcmm::network::ULActionAA4 Class Reference . . . . .	1194
10.322.1 Member Function Documentation . . . . .	1194
10.322.1.1 PerformAction() . . . . .	1195
10.323 gdcmm::network::ULActionAA5 Class Reference . . . . .	1195
10.323.1 Member Function Documentation . . . . .	1196
10.323.1.1 PerformAction() . . . . .	1196
10.324 gdcmm::network::ULActionAA6 Class Reference . . . . .	1196
10.324.1 Member Function Documentation . . . . .	1197
10.324.1.1 PerformAction() . . . . .	1197
10.325 gdcmm::network::ULActionAA7 Class Reference . . . . .	1198
10.325.1 Member Function Documentation . . . . .	1198
10.325.1.1 PerformAction() . . . . .	1199
10.326 gdcmm::network::ULActionAA8 Class Reference . . . . .	1199
10.326.1 Member Function Documentation . . . . .	1200
10.326.1.1 PerformAction() . . . . .	1200
10.327 gdcmm::network::ULActionAE1 Class Reference . . . . .	1200
10.327.1 Member Function Documentation . . . . .	1201
10.327.1.1 PerformAction() . . . . .	1201
10.328 gdcmm::network::ULActionAE2 Class Reference . . . . .	1202
10.328.1 Member Function Documentation . . . . .	1202
10.328.1.1 PerformAction() . . . . .	1203

---

10.329 gdcn::network::ULActionAE3 Class Reference . . . . .	1203
10.329.1 Member Function Documentation . . . . .	1204
10.329.1.1 PerformAction() . . . . .	1204
10.330 gdcn::network::ULActionAE4 Class Reference . . . . .	1204
10.330.1 Member Function Documentation . . . . .	1205
10.330.1.1 PerformAction() . . . . .	1205
10.331 gdcn::network::ULActionAE5 Class Reference . . . . .	1206
10.331.1 Member Function Documentation . . . . .	1206
10.331.1.1 PerformAction() . . . . .	1207
10.332 gdcn::network::ULActionAE6 Class Reference . . . . .	1207
10.332.1 Member Function Documentation . . . . .	1208
10.332.1.1 PerformAction() . . . . .	1208
10.333 gdcn::network::ULActionAE7 Class Reference . . . . .	1208
10.333.1 Member Function Documentation . . . . .	1209
10.333.1.1 PerformAction() . . . . .	1209
10.334 gdcn::network::ULActionAE8 Class Reference . . . . .	1210
10.334.1 Member Function Documentation . . . . .	1210
10.334.1.1 PerformAction() . . . . .	1211
10.335 gdcn::network::ULActionAR1 Class Reference . . . . .	1211
10.335.1 Member Function Documentation . . . . .	1212
10.335.1.1 PerformAction() . . . . .	1212
10.336 gdcn::network::ULActionAR10 Class Reference . . . . .	1212
10.336.1 Member Function Documentation . . . . .	1213
10.336.1.1 PerformAction() . . . . .	1213
10.337 gdcn::network::ULActionAR2 Class Reference . . . . .	1214
10.337.1 Member Function Documentation . . . . .	1214
10.337.1.1 PerformAction() . . . . .	1215
10.338 gdcn::network::ULActionAR3 Class Reference . . . . .	1215
10.338.1 Member Function Documentation . . . . .	1216
10.338.1.1 PerformAction() . . . . .	1216
10.339 gdcn::network::ULActionAR4 Class Reference . . . . .	1216
10.339.1 Member Function Documentation . . . . .	1217
10.339.1.1 PerformAction() . . . . .	1217
10.340 gdcn::network::ULActionAR5 Class Reference . . . . .	1218
10.340.1 Member Function Documentation . . . . .	1218
10.340.1.1 PerformAction() . . . . .	1219
10.341 gdcn::network::ULActionAR6 Class Reference . . . . .	1219
10.341.1 Member Function Documentation . . . . .	1220
10.341.1.1 PerformAction() . . . . .	1220

---

10.342	gdcM::network::ULActionAR7 Class Reference	1220
10.342.1	Member Function Documentation	1221
10.342.1.1	PerformAction()	1221
10.343	gdcM::network::ULActionAR8 Class Reference	1222
10.343.1	Member Function Documentation	1222
10.343.1.1	PerformAction()	1223
10.344	gdcM::network::ULActionAR9 Class Reference	1223
10.344.1	Member Function Documentation	1224
10.344.1.1	PerformAction()	1224
10.345	gdcM::network::ULActionDT1 Class Reference	1224
10.345.1	Member Function Documentation	1225
10.345.1.1	PerformAction()	1225
10.346	gdcM::network::ULActionDT2 Class Reference	1226
10.346.1	Member Function Documentation	1226
10.346.1.1	PerformAction()	1227
10.347	gdcM::network::ULBasicCallback Class Reference	1227
10.347.1	Detailed Description	1228
10.347.2	Constructor & Destructor Documentation	1228
10.347.2.1	ULBasicCallback()	1228
10.347.2.2	~ULBasicCallback()	1228
10.347.3	Member Function Documentation	1228
10.347.3.1	GetDataSets()	1228
10.347.3.2	GetResponses()	1229
10.347.3.3	HandleDataSet()	1229
10.347.3.4	HandleResponse()	1229
10.348	gdcM::network::ULConnection Class Reference	1229
10.348.1	Detailed Description	1230
10.348.2	Constructor & Destructor Documentation	1231
10.348.2.1	ULConnection() [1/2]	1231
10.348.2.2	~ULConnection()	1231
10.348.2.3	ULConnection() [2/2]	1231
10.348.3	Member Function Documentation	1231
10.348.3.1	AddAcceptedPresentationContext()	1231
10.348.3.2	FindContext()	1231
10.348.3.3	GetAcceptedPresentationContexts() [1/2]	1232
10.348.3.4	GetAcceptedPresentationContexts() [2/2]	1232
10.348.3.5	GetConnectionInfo()	1232
10.348.3.6	GetMaxPDUSize()	1232
10.348.3.7	GetPresentationContextACByID()	1232

---

10.348.3.8	GetPresentationContextIDFromPresentationContext()	1232
10.348.3.9	GetPresentationContextRQByID()	1233
10.348.3.10	GetPresentationContexts()	1233
10.348.3.11	GetProtocol()	1233
10.348.3.12	GetState()	1233
10.348.3.13	GetTimer()	1233
10.348.3.14	InitializeConnection()	1233
10.348.3.15	InitializeIncomingConnection()	1234
10.348.3.16	operator=()	1234
10.348.3.17	SetMaxPDUSize()	1234
10.348.3.18	SetPresentationContexts() [1/2]	1234
10.348.3.19	SetPresentationContexts() [2/2]	1234
10.348.3.20	SetState()	1234
10.348.3.21	StopProtocol()	1235
10.348.4	Friends And Related Function Documentation	1235
10.348.4.1	ULActionAE6	1235
10.348.4.2	ULConnectionManager	1235
10.349	gdcn::network::ULConnectionCallback Class Reference	1235
10.349.1	Detailed Description	1236
10.349.2	Constructor & Destructor Documentation	1236
10.349.2.1	ULConnectionCallback()	1236
10.349.2.2	~ULConnectionCallback()	1236
10.349.3	Member Function Documentation	1237
10.349.3.1	DataSetHandled()	1237
10.349.3.2	DataSetHandles()	1237
10.349.3.3	HandleDataSet()	1237
10.349.3.4	HandleResponse()	1237
10.349.3.5	ResetHandledDataSet()	1237
10.349.3.6	SetImplicitFlag()	1237
10.349.4	Member Data Documentation	1238
10.349.4.1	mImplicit	1238
10.350	gdcn::network::ULConnectionInfo Class Reference	1238
10.350.1	Detailed Description	1238
10.350.2	Constructor & Destructor Documentation	1238
10.350.2.1	ULConnectionInfo()	1239
10.350.3	Member Function Documentation	1239
10.350.3.1	GetCalledAETitle()	1239
10.350.3.2	GetCalledComputerName()	1239
10.350.3.3	GetCalledIPAddress()	1239

---

10.350.3.4	GetCalledIPPort()	1239
10.350.3.5	GetCallingAETitle()	1239
10.350.3.6	GetMaxPDULength()	1239
10.350.3.7	Initialize()	1240
10.350.3.8	SetMaxPDULength()	1240
10.351	gdcmm::network::ULConnectionManager Class Reference	1240
10.351.1	Detailed Description	1242
10.351.2	Constructor & Destructor Documentation	1242
10.351.2.1	ULConnectionManager() [1/2]	1242
10.351.2.2	ULConnectionManager() [2/2]	1242
10.351.2.3	~ULConnectionManager()	1242
10.351.3	Member Function Documentation	1243
10.351.3.1	BreakConnection()	1243
10.351.3.2	BreakConnectionNow()	1243
10.351.3.3	EstablishConnection()	1243
10.351.3.4	EstablishConnectionMove()	1243
10.351.3.5	RunEventLoop()	1244
10.351.3.6	RunMoveEventLoop()	1244
10.351.3.7	SendEcho()	1244
10.351.3.8	SendFind() [1/2]	1244
10.351.3.9	SendFind() [2/2]	1244
10.351.3.10	SendMove() [1/2]	1244
10.351.3.11	SendMove() [2/2]	1245
10.351.3.12	SendNAction() [1/2]	1245
10.351.3.13	SendNAction() [2/2]	1245
10.351.3.14	SendNCreate() [1/2]	1245
10.351.3.15	SendNCreate() [2/2]	1245
10.351.3.16	SendNDelete() [1/2]	1245
10.351.3.17	SendNDelete() [2/2]	1246
10.351.3.18	SendNEventReport() [1/2]	1246
10.351.3.19	SendNEventReport() [2/2]	1246
10.351.3.20	SendNGet() [1/2]	1246
10.351.3.21	SendNGet() [2/2]	1246
10.351.3.22	SendNSet() [1/2]	1246
10.351.3.23	SendNSet() [2/2]	1247
10.351.3.24	SendStore() [1/2]	1247
10.351.3.25	SendStore() [2/2]	1247
10.351.4	Member Data Documentation	1247
10.351.4.1	mConnection	1247



---

10.351.4.2 mSecondaryConnection	1247
10.351.4.3 mTransitions	1248
10.352 gdcmm::network::ULEvent Class Reference	1248
10.352.1 Detailed Description	1248
10.352.2 Constructor & Destructor Documentation	1248
10.352.2.1 ULEvent() [1/2]	1249
10.352.2.2 ULEvent() [2/2]	1249
10.352.2.3 ~ULEvent()	1249
10.352.3 Member Function Documentation	1249
10.352.3.1 GetDataSetPos()	1249
10.352.3.2 GetEvent()	1249
10.352.3.3 GetIStream()	1249
10.352.3.4 GetPDUs()	1250
10.352.3.5 SetEvent()	1250
10.352.3.6 SetPDU()	1250
10.353 gdcmm::network::ULTransitionTable Class Reference	1250
10.353.1 Detailed Description	1250
10.353.2 Constructor & Destructor Documentation	1251
10.353.2.1 ULTransitionTable()	1251
10.353.3 Member Function Documentation	1251
10.353.3.1 HandleEvent()	1251
10.353.3.2 PrintTable()	1251
10.354 gdcmm::network::ULWritingCallback Class Reference	1252
10.354.1 Constructor & Destructor Documentation	1253
10.354.1.1 ULWritingCallback()	1253
10.354.1.2 ~ULWritingCallback()	1253
10.354.2 Member Function Documentation	1253
10.354.2.1 HandleDataSet()	1253
10.354.2.2 HandleResponse()	1253
10.354.2.3 SetDirectory()	1254
10.355 gdcmm::UNExplicitDataElement Class Reference	1254
10.355.1 Detailed Description	1255
10.355.2 Member Function Documentation	1255
10.355.2.1 GetLength()	1256
10.355.2.2 Read()	1256
10.355.2.3 ReadPreValue()	1256
10.355.2.4 ReadValue()	1256
10.355.2.5 ReadWithLength()	1256
10.356 gdcmm::UNExplicitImplicitDataElement Class Reference	1257

---

10.356.1 Detailed Description . . . . .	1258
10.356.2 Member Function Documentation . . . . .	1258
10.356.2.1 GetLength() . . . . .	1258
10.356.2.2 Read() . . . . .	1258
10.356.2.3 ReadPreValue() . . . . .	1258
10.356.2.4 ReadValue() . . . . .	1259
10.357 gdcM::Unpacker12Bits Class Reference . . . . .	1259
10.357.1 Detailed Description . . . . .	1259
10.357.2 Member Function Documentation . . . . .	1259
10.357.2.1 Pack() . . . . .	1260
10.357.2.2 Unpack() . . . . .	1260
10.358 gdcM::Usage Class Reference . . . . .	1260
10.358.1 Detailed Description . . . . .	1261
10.358.2 Member Enumeration Documentation . . . . .	1261
10.358.2.1 UsageType . . . . .	1261
10.358.3 Constructor & Destructor Documentation . . . . .	1262
10.358.3.1 Usage() . . . . .	1262
10.358.4 Member Function Documentation . . . . .	1262
10.358.4.1 GetUsageString() . . . . .	1262
10.358.4.2 GetUsageType() . . . . .	1262
10.358.4.3 operator UsageType() . . . . .	1262
10.358.5 Friends And Related Function Documentation . . . . .	1262
10.358.5.1 operator<< . . . . .	1262
10.359 gdcM::UserEvent Class Reference . . . . .	1263
10.360 gdcM::network::UserInformation Class Reference . . . . .	1264
10.360.1 Detailed Description . . . . .	1264
10.360.2 Constructor & Destructor Documentation . . . . .	1264
10.360.2.1 UserInformation() [1/2] . . . . .	1264
10.360.2.2 ~UserInformation() . . . . .	1264
10.360.2.3 UserInformation() [2/2] . . . . .	1265
10.360.3 Member Function Documentation . . . . .	1265
10.360.3.1 AddRoleSelectionSub() . . . . .	1265
10.360.3.2 AddSOPClassExtendedNegociationSub() . . . . .	1265
10.360.3.3 GetMaximumLengthSub() [1/2] . . . . .	1265
10.360.3.4 GetMaximumLengthSub() [2/2] . . . . .	1265
10.360.3.5 operator=() . . . . .	1265
10.360.3.6 Print() . . . . .	1266
10.360.3.7 Read() . . . . .	1266
10.360.3.8 Size() . . . . .	1266

---

10.360.3.9 Write()	1266
10.361 gdcm::UUIDGenerator Class Reference	1266
10.361.1 Detailed Description	1267
10.361.2 Member Function Documentation	1267
10.361.2.1 Generate()	1267
10.361.2.2 IsValid()	1267
10.362 gdcm::Validate Class Reference	1267
10.362.1 Detailed Description	1268
10.362.2 Constructor & Destructor Documentation	1268
10.362.2.1 Validate()	1268
10.362.2.2 ~Validate()	1268
10.362.3 Member Function Documentation	1268
10.362.3.1 GetValidatedFile()	1268
10.362.3.2 SetFile()	1269
10.362.3.3 Validation()	1269
10.362.4 Member Data Documentation	1269
10.362.4.1 F	1269
10.362.4.2 V	1269
10.363 gdcm::Value Class Reference	1270
10.363.1 Detailed Description	1271
10.363.2 Constructor & Destructor Documentation	1271
10.363.2.1 Value()	1271
10.363.2.2 ~Value()	1271
10.363.3 Member Function Documentation	1271
10.363.3.1 Clear()	1271
10.363.3.2 GetLength()	1272
10.363.3.3 operator==( )	1272
10.363.3.4 SetLength()	1272
10.363.3.5 SetLengthOnly()	1272
10.363.4 Friends And Related Function Documentation	1272
10.363.4.1 DataElement	1272
10.364 gdcm::ValueIO< TDE, TSwap, TType > Class Template Reference	1273
10.364.1 Detailed Description	1273
10.364.2 Member Function Documentation	1273
10.364.2.1 Read()	1273
10.364.2.2 Write()	1273
10.365 gdcm::MrProtocol::Vector3 Struct Reference	1274
10.365.1 Member Data Documentation	1274
10.365.1.1 dCor	1274

---

10.365.1.2 dSag	1274
10.365.1.3 dTra	1274
10.366 gdcmm::Version Class Reference	1274
10.366.1 Detailed Description	1275
10.366.2 Constructor & Destructor Documentation	1275
10.366.2.1 Version()	1275
10.366.2.2 ~Version()	1275
10.366.3 Member Function Documentation	1275
10.366.3.1 GetBuildVersion()	1276
10.366.3.2 GetMajorVersion()	1276
10.366.3.3 GetMinorVersion()	1276
10.366.3.4 GetVersion()	1276
10.366.3.5 Print()	1276
10.366.4 Friends And Related Function Documentation	1276
10.366.4.1 operator<<	1276
10.367 gdcmm::VL Class Reference	1277
10.367.1 Detailed Description	1278
10.367.2 Member Typedef Documentation	1278
10.367.2.1 Type	1278
10.367.3 Constructor & Destructor Documentation	1278
10.367.3.1 VL()	1278
10.367.4 Member Function Documentation	1278
10.367.4.1 GetLength()	1278
10.367.4.2 GetVL16Max()	1279
10.367.4.3 GetVL32Max()	1279
10.367.4.4 IsOdd()	1279
10.367.4.5 IsUndefined()	1279
10.367.4.6 operator uint32_t()	1279
10.367.4.7 operator++() [1/2]	1279
10.367.4.8 operator++() [2/2]	1279
10.367.4.9 operator+=()	1280
10.367.4.10 Read()	1280
10.367.4.11 Read16()	1280
10.367.4.12 SetToUndefined()	1280
10.367.4.13 Write()	1280
10.367.4.14 Write16()	1280
10.367.5 Friends And Related Function Documentation	1281
10.367.5.1 operator<<	1281
10.368 gdcmm::VM Class Reference	1281

---

10.368.1 Detailed Description . . . . .	1282
10.368.2 Member Enumeration Documentation . . . . .	1283
10.368.2.1 VMType . . . . .	1283
10.368.3 Constructor & Destructor Documentation . . . . .	1284
10.368.3.1 VM() . . . . .	1284
10.368.4 Member Function Documentation . . . . .	1284
10.368.4.1 Compatible() . . . . .	1284
10.368.4.2 GetIndex() . . . . .	1284
10.368.4.3 GetLength() . . . . .	1284
10.368.4.4 GetNumberOfElementsFromArray() . . . . .	1284
10.368.4.5 GetVMString() . . . . .	1285
10.368.4.6 GetVMType() . . . . .	1285
10.368.4.7 GetVMTypeFromLength() . . . . .	1285
10.368.4.8 IsValid() . . . . .	1285
10.368.4.9 operator VMType() . . . . .	1285
10.368.5 Friends And Related Function Documentation . . . . .	1285
10.368.5.1 operator<< . . . . .	1285
10.369 gdcM::VMToLength< T > Struct Template Reference . . . . .	1286
10.370 gdcM::VR Class Reference . . . . .	1286
10.370.1 Detailed Description . . . . .	1288
10.370.2 Member Enumeration Documentation . . . . .	1288
10.370.2.1 VRType . . . . .	1288
10.370.3 Constructor & Destructor Documentation . . . . .	1289
10.370.3.1 VR() . . . . .	1289
10.370.4 Member Function Documentation . . . . .	1289
10.370.4.1 CanDisplay() . . . . .	1290
10.370.4.2 Compatible() . . . . .	1290
10.370.4.3 GetLength() [1/2] . . . . .	1290
10.370.4.4 GetLength() [2/2] . . . . .	1290
10.370.4.5 GetSize() . . . . .	1290
10.370.4.6 GetSizeof() . . . . .	1290
10.370.4.7 GetVRString() . . . . .	1291
10.370.4.8 GetVRStringFromFile() . . . . .	1291
10.370.4.9 GetVRType() . . . . .	1291
10.370.4.10 GetVRTypeFromFile() . . . . .	1291
10.370.4.11 IsASCII() . . . . .	1291
10.370.4.12 IsASCII2() . . . . .	1291
10.370.4.13 IsBinary() . . . . .	1292
10.370.4.14 IsBinary2() . . . . .	1292

---

10.370.4.15 IsDual()	1292
10.370.4.16 IsSwap()	1292
10.370.4.17 IsValid() [1/2]	1292
10.370.4.18 IsValid() [2/2]	1292
10.370.4.19 IsVRFile()	1293
10.370.4.20 operator VRType()	1293
10.370.4.21 Read()	1293
10.370.4.22 Write()	1293
10.370.5 Friends And Related Function Documentation	1293
10.370.5.1 operator<<	1293
10.371 gdcM::VR16ExplicitDataElement Class Reference	1294
10.371.1 Detailed Description	1295
10.371.2 Member Function Documentation	1295
10.371.2.1 GetLength()	1295
10.371.2.2 Read()	1295
10.371.2.3 ReadPreValue()	1295
10.371.2.4 ReadValue()	1296
10.371.2.5 ReadWithLength()	1296
10.372 gdcM::VRToEncoding< T > Struct Template Reference	1296
10.373 gdcM::VRToType< T > Struct Template Reference	1296
10.374 gdcM::VRVLSize< T > Class Template Reference	1297
10.375 gdcM::VRVLSize< 0 > Class Reference	1297
10.375.1 Member Function Documentation	1297
10.375.1.1 Read()	1297
10.375.1.2 Write()	1297
10.376 gdcM::VRVLSize< 1 > Class Reference	1297
10.376.1 Member Function Documentation	1298
10.376.1.1 Read()	1298
10.376.1.2 Write()	1298
10.377 vtkGDCMImageReader Class Reference	1298
10.377.1 Detailed Description	1301
10.377.2 Constructor & Destructor Documentation	1301
10.377.2.1 vtkGDCMImageReader()	1301
10.377.2.2 ~vtkGDCMImageReader()	1301
10.377.3 Member Function Documentation	1301
10.377.3.1 CanReadFile()	1301
10.377.3.2 ExecuteData()	1302
10.377.3.3 ExecuteInformation()	1302
10.377.3.4 FillMedicalImageInformation()	1302

---

10.377.3.5 GetDescriptiveName()	1302
10.377.3.6 GetFileExtensions()	1302
10.377.3.7 GetIconImage()	1302
10.377.3.8 GetOverlay()	1302
10.377.3.9 LoadSingleFile()	1303
10.377.3.10 New()	1303
10.377.3.11 PrintSelf()	1303
10.377.3.12 RequestDataCompat()	1303
10.377.3.13 RequestInformationCompat()	1303
10.377.3.14 SetCurve()	1304
10.377.3.15 SetFileNames()	1304
10.377.3.16 SetFilePattern()	1304
10.377.3.17 SetFilePrefix()	1304
10.377.3.18 SetMedicalImageProperties()	1304
10.377.3.19 vtkBooleanMacro() [1/5]	1304
10.377.3.20 vtkBooleanMacro() [2/5]	1305
10.377.3.21 vtkBooleanMacro() [3/5]	1305
10.377.3.22 vtkBooleanMacro() [4/5]	1305
10.377.3.23 vtkBooleanMacro() [5/5]	1305
10.377.3.24 vtkGetMacro() [1/11]	1305
10.377.3.25 vtkGetMacro() [2/11]	1305
10.377.3.26 vtkGetMacro() [3/11]	1306
10.377.3.27 vtkGetMacro() [4/11]	1306
10.377.3.28 vtkGetMacro() [5/11]	1306
10.377.3.29 vtkGetMacro() [6/11]	1306
10.377.3.30 vtkGetMacro() [7/11]	1306
10.377.3.31 vtkGetMacro() [8/11]	1306
10.377.3.32 vtkGetMacro() [9/11]	1307
10.377.3.33 vtkGetMacro() [10/11]	1307
10.377.3.34 vtkGetMacro() [11/11]	1307
10.377.3.35 vtkGetObjectMacro() [1/4]	1307
10.377.3.36 vtkGetObjectMacro() [2/4]	1307
10.377.3.37 vtkGetObjectMacro() [3/4]	1307
10.377.3.38 vtkGetObjectMacro() [4/4]	1308
10.377.3.39 vtkGetStringMacro() [1/2]	1308
10.377.3.40 vtkGetStringMacro() [2/2]	1308
10.377.3.41 vtkGetVector3Macro()	1308
10.377.3.42 vtkGetVector6Macro()	1308
10.377.3.43 vtkSetMacro() [1/4]	1308

---

10.377.3.44	vtkSetMacro() [2/4]	1309
10.377.3.45	vtkSetMacro() [3/4]	1309
10.377.3.46	vtkSetMacro() [4/4]	1309
10.377.3.47	vtkSetVector6Macro()	1309
10.377.3.48	vtkTypeMacro()	1309
10.377.4	Member Data Documentation	1309
10.377.4.1	ApplyInverseVideo	1310
10.377.4.2	ApplyLookupTable	1310
10.377.4.3	ApplyPlanarConfiguration	1310
10.377.4.4	ApplyShiftScale	1310
10.377.4.5	ApplyYBRToRGB	1310
10.377.4.6	Curve	1310
10.377.4.7	DirectionCosines	1310
10.377.4.8	FileNames	1311
10.377.4.9	ForceRescale	1311
10.377.4.10	IconDataScalarType	1311
10.377.4.11	IconImageDataExtent	1311
10.377.4.12	IconNumberOfScalarComponents	1311
10.377.4.13	ImageFormat	1311
10.377.4.14	ImageOrientationPatient	1311
10.377.4.15	ImagePositionPatient	1312
10.377.4.16	LoadIconImage	1312
10.377.4.17	LoadOverlays	1312
10.377.4.18	LossyFlag	1312
10.377.4.19	MedicalImageProperties	1312
10.377.4.20	NumberOfIconImages	1312
10.377.4.21	NumberOfOverlays	1312
10.377.4.22	PlanarConfiguration	1313
10.377.4.23	Scale	1313
10.377.4.24	Shift	1313
10.378	vtkGDCMImageReader2 Class Reference	1313
10.378.1	Detailed Description	1316
10.378.2	Constructor & Destructor Documentation	1316
10.378.2.1	vtkGDCMImageReader2()	1316
10.378.2.2	~vtkGDCMImageReader2()	1316
10.378.3	Member Function Documentation	1316
10.378.3.1	CanReadFile()	1316
10.378.3.2	FillMedicalImageInformation()	1316
10.378.3.3	GetDescriptiveName()	1316



---

10.378.3.4 GetFileExtensions()	1317
10.378.3.5 GetIconImage()	1317
10.378.3.6 GetIconImagePort()	1317
10.378.3.7 GetOverlay()	1317
10.378.3.8 GetOverlayPort()	1317
10.378.3.9 LoadSingleFile()	1317
10.378.3.10 New()	1318
10.378.3.11 PrintSelf()	1318
10.378.3.12 ProcessRequest()	1318
10.378.3.13 RequestData()	1318
10.378.3.14 RequestDataCompat()	1318
10.378.3.15 RequestInformation()	1319
10.378.3.16 RequestInformationCompat()	1319
10.378.3.17 SetCurve()	1319
10.378.3.18 SetFilePattern()	1319
10.378.3.19 SetFilePrefix()	1319
10.378.3.20 SetMedicalImageProperties()	1319
10.378.3.21 vtkBooleanMacro() [1/5]	1320
10.378.3.22 vtkBooleanMacro() [2/5]	1320
10.378.3.23 vtkBooleanMacro() [3/5]	1320
10.378.3.24 vtkBooleanMacro() [4/5]	1320
10.378.3.25 vtkBooleanMacro() [5/5]	1320
10.378.3.26 vtkGetMacro() [1/11]	1320
10.378.3.27 vtkGetMacro() [2/11]	1321
10.378.3.28 vtkGetMacro() [3/11]	1321
10.378.3.29 vtkGetMacro() [4/11]	1321
10.378.3.30 vtkGetMacro() [5/11]	1321
10.378.3.31 vtkGetMacro() [6/11]	1321
10.378.3.32 vtkGetMacro() [7/11]	1321
10.378.3.33 vtkGetMacro() [8/11]	1322
10.378.3.34 vtkGetMacro() [9/11]	1322
10.378.3.35 vtkGetMacro() [10/11]	1322
10.378.3.36 vtkGetMacro() [11/11]	1322
10.378.3.37 vtkGetObjectMacro() [1/2]	1322
10.378.3.38 vtkGetObjectMacro() [2/2]	1322
10.378.3.39 vtkGetStringMacro() [1/2]	1323
10.378.3.40 vtkGetStringMacro() [2/2]	1323
10.378.3.41 vtkGetVector3Macro()	1323
10.378.3.42 vtkGetVector6Macro()	1323

---

10.378.3.43	vtkSetMacro() [1/4]	1323
10.378.3.44	vtkSetMacro() [2/4]	1323
10.378.3.45	vtkSetMacro() [3/4]	1324
10.378.3.46	vtkSetMacro() [4/4]	1324
10.378.3.47	vtkSetVector6Macro()	1324
10.378.3.48	vtkTypeMacro()	1324
10.378.4	Member Data Documentation	1324
10.378.4.1	ApplyInverseVideo	1324
10.378.4.2	ApplyLookupTable	1324
10.378.4.3	ApplyPlanarConfiguration	1325
10.378.4.4	ApplyShiftScale	1325
10.378.4.5	ApplyYBRToRGB	1325
10.378.4.6	Curve	1325
10.378.4.7	DirectionCosines	1325
10.378.4.8	ForceRescale	1325
10.378.4.9	IconDataScalarType	1325
10.378.4.10	IconImageDataExtent	1326
10.378.4.11	IconNumberOfScalarComponents	1326
10.378.4.12	ImageFormat	1326
10.378.4.13	ImageOrientationPatient	1326
10.378.4.14	ImagePositionPatient	1326
10.378.4.15	LoadIconImage	1326
10.378.4.16	LoadOverlays	1326
10.378.4.17	LossyFlag	1327
10.378.4.18	NumberOfIconImages	1327
10.378.4.19	NumberOfOverlays	1327
10.378.4.20	PlanarConfiguration	1327
10.378.4.21	Scale	1327
10.378.4.22	Shift	1327
10.379	vtkGDCMImageWriter Class Reference	1328
10.379.1	Detailed Description	1330
10.379.2	Member Enumeration Documentation	1330
10.379.2.1	CompressionTypes	1330
10.379.3	Constructor & Destructor Documentation	1330
10.379.3.1	vtkGDCMImageWriter()	1330
10.379.3.2	~vtkGDCMImageWriter()	1330
10.379.4	Member Function Documentation	1330
10.379.4.1	GetDescriptiveName()	1331
10.379.4.2	GetFileExtensions()	1331

---

10.379.4.3 GetFileName()	1331
10.379.4.4 New()	1331
10.379.4.5 PrintSelf()	1331
10.379.4.6 SetDirectionCosines()	1331
10.379.4.7 SetDirectionCosinesFromImageOrientationPatient()	1332
10.379.4.8 SetFileNames()	1332
10.379.4.9 SetMedicalImageProperties()	1332
10.379.4.10 vtkBooleanMacro() [1/2]	1332
10.379.4.11 vtkBooleanMacro() [2/2]	1332
10.379.4.12 vtkGetMacro() [1/7]	1333
10.379.4.13 vtkGetMacro() [2/7]	1333
10.379.4.14 vtkGetMacro() [3/7]	1333
10.379.4.15 vtkGetMacro() [4/7]	1333
10.379.4.16 vtkGetMacro() [5/7]	1333
10.379.4.17 vtkGetMacro() [6/7]	1333
10.379.4.18 vtkGetMacro() [7/7]	1334
10.379.4.19 vtkGetObjectMacro() [1/3]	1334
10.379.4.20 vtkGetObjectMacro() [2/3]	1334
10.379.4.21 vtkGetObjectMacro() [3/3]	1334
10.379.4.22 vtkGetStringMacro() [1/2]	1334
10.379.4.23 vtkGetStringMacro() [2/2]	1334
10.379.4.24 vtkSetMacro() [1/7]	1335
10.379.4.25 vtkSetMacro() [2/7]	1335
10.379.4.26 vtkSetMacro() [3/7]	1335
10.379.4.27 vtkSetMacro() [4/7]	1335
10.379.4.28 vtkSetMacro() [5/7]	1335
10.379.4.29 vtkSetMacro() [6/7]	1335
10.379.4.30 vtkSetMacro() [7/7]	1336
10.379.4.31 vtkSetStringMacro() [1/2]	1336
10.379.4.32 vtkSetStringMacro() [2/2]	1336
10.379.4.33 vtkTypeMacro()	1336
10.379.4.34 Write()	1336
10.379.4.35 WriteGDCMData()	1337
10.379.4.36 WriteSlice()	1337
10.380 vtkGDCMMedicalImageProperties Class Reference	1337
10.380.1 Constructor & Destructor Documentation	1338
10.380.1.1 vtkGDCMMedicalImageProperties()	1338
10.380.1.2 ~vtkGDCMMedicalImageProperties()	1338
10.380.2 Member Function Documentation	1338

---

10.380.2.1 Clear()	1339
10.380.2.2 GetFile()	1339
10.380.2.3 New()	1339
10.380.2.4 PrintSelf()	1339
10.380.2.5 PushBackFile()	1339
10.380.2.6 vtkTypeMacro()	1339
10.380.3 Friends And Related Function Documentation	1339
10.380.3.1 vtkGDCMImageReader	1340
10.380.3.2 vtkGDCMImageReader2	1340
10.380.3.3 vtkGDCMImageWriter	1340
10.381 vtkGDCMPolyDataReader Class Reference	1340
10.381.1 Detailed Description	1342
10.381.2 Constructor & Destructor Documentation	1342
10.381.2.1 vtkGDCMPolyDataReader()	1342
10.381.2.2 ~vtkGDCMPolyDataReader()	1342
10.381.3 Member Function Documentation	1342
10.381.3.1 FillMedicalImageInformation()	1342
10.381.3.2 New()	1342
10.381.3.3 PrintSelf()	1343
10.381.3.4 RequestData()	1343
10.381.3.5 RequestData_HemodynamicWaveformStorage()	1343
10.381.3.6 RequestData_RTStructureSetStorage()	1343
10.381.3.7 RequestInformation()	1343
10.381.3.8 RequestInformation_HemodynamicWaveformStorage()	1343
10.381.3.9 RequestInformation_RTStructureSetStorage()	1344
10.381.3.10 vtkGetObjectMacro() [1/2]	1344
10.381.3.11 vtkGetObjectMacro() [2/2]	1344
10.381.3.12 vtkGetStringMacro()	1344
10.381.3.13 vtkSetStringMacro()	1344
10.381.3.14 vtkTypeMacro()	1344
10.381.4 Member Data Documentation	1345
10.381.4.1 FileName	1345
10.381.4.2 MedicalImageProperties	1345
10.381.4.3 RTStructSetProperties	1345
10.382 vtkGDCMPolyDataWriter Class Reference	1345
10.382.1 Detailed Description	1347
10.382.2 Constructor & Destructor Documentation	1347
10.382.2.1 vtkGDCMPolyDataWriter()	1347
10.382.2.2 ~vtkGDCMPolyDataWriter()	1347

---

10.382.3 Member Function Documentation . . . . .	1347
10.382.3.1 InitializeRTStructSet() . . . . .	1347
10.382.3.2 New() . . . . .	1348
10.382.3.3 PrintSelf() . . . . .	1348
10.382.3.4 SetMedicalImageProperties() . . . . .	1348
10.382.3.5 SetNumberOfInputPorts() . . . . .	1348
10.382.3.6 SetRTStructSetProperties() . . . . .	1349
10.382.3.7 vtkTypeMacro() . . . . .	1349
10.382.3.8 WriteData() . . . . .	1349
10.382.3.9 WriteRTSTRUCTData() . . . . .	1349
10.382.3.10 WriteRTSTRUCTInfo() . . . . .	1349
10.382.4 Member Data Documentation . . . . .	1349
10.382.4.1 MedicalImageProperties . . . . .	1350
10.382.4.2 RTStructSetProperties . . . . .	1350
10.383 vtkGDCMTesting Class Reference . . . . .	1350
10.383.1 Detailed Description . . . . .	1351
10.383.2 Member Typedef Documentation . . . . .	1351
10.383.2.1 MD5MetalImagesType . . . . .	1351
10.383.3 Constructor & Destructor Documentation . . . . .	1351
10.383.3.1 vtkGDCMTesting() . . . . .	1352
10.383.3.2 ~vtkGDCMTesting() . . . . .	1352
10.383.4 Member Function Documentation . . . . .	1352
10.383.4.1 GetGDCMDataRoot() . . . . .	1352
10.383.4.2 GetMD5MetalImage() . . . . .	1352
10.383.4.3 GetMHDMD5FromFile() . . . . .	1352
10.383.4.4 GetNumberOfMD5MetalImages() . . . . .	1353
10.383.4.5 GetRAWMD5FromFile() . . . . .	1353
10.383.4.6 GetVTKDataRoot() . . . . .	1353
10.383.4.7 New() . . . . .	1353
10.383.4.8 PrintSelf() . . . . .	1353
10.383.4.9 vtkTypeMacro() . . . . .	1354
10.384 vtkGDCMThreadedImageReader Class Reference . . . . .	1354
10.384.1 Constructor & Destructor Documentation . . . . .	1355
10.384.1.1 vtkGDCMThreadedImageReader() . . . . .	1356
10.384.1.2 ~vtkGDCMThreadedImageReader() . . . . .	1356
10.384.2 Member Function Documentation . . . . .	1356
10.384.2.1 ExecuteData() . . . . .	1356
10.384.2.2 ExecuteInformation() . . . . .	1356
10.384.2.3 New() . . . . .	1356

---

10.384.2.4 PrintSelf()	1356
10.384.2.5 ReadFiles()	1357
10.384.2.6 RequestDataCompat()	1357
10.384.2.7 vtkBooleanMacro()	1357
10.384.2.8 vtkGetMacro()	1357
10.384.2.9 vtkSetMacro() [1/3]	1357
10.384.2.10 vtkSetMacro() [2/3]	1357
10.384.2.11 vtkSetMacro() [3/3]	1358
10.384.2.12 vtkTypeMacro()	1358
10.385 vtkGDCMThreadedImageReader2 Class Reference	1358
10.385.1 Constructor & Destructor Documentation	1360
10.385.1.1 vtkGDCMThreadedImageReader2()	1360
10.385.1.2 ~vtkGDCMThreadedImageReader2()	1360
10.385.2 Member Function Documentation	1360
10.385.2.1 GetFileName()	1360
10.385.2.2 New()	1360
10.385.2.3 PrintSelf()	1361
10.385.2.4 RequestInformation()	1361
10.385.2.5 SetFileName()	1361
10.385.2.6 SetFileNames()	1361
10.385.2.7 SplitExtent()	1361
10.385.2.8 ThreadedRequestData()	1362
10.385.2.9 vtkBooleanMacro() [1/3]	1362
10.385.2.10 vtkBooleanMacro() [2/3]	1362
10.385.2.11 vtkBooleanMacro() [3/3]	1362
10.385.2.12 vtkGetMacro() [1/8]	1362
10.385.2.13 vtkGetMacro() [2/8]	1363
10.385.2.14 vtkGetMacro() [3/8]	1363
10.385.2.15 vtkGetMacro() [4/8]	1363
10.385.2.16 vtkGetMacro() [5/8]	1363
10.385.2.17 vtkGetMacro() [6/8]	1363
10.385.2.18 vtkGetMacro() [7/8]	1363
10.385.2.19 vtkGetMacro() [8/8]	1364
10.385.2.20 vtkGetObjectMacro()	1364
10.385.2.21 vtkGetVector3Macro() [1/2]	1364
10.385.2.22 vtkGetVector3Macro() [2/2]	1364
10.385.2.23 vtkGetVector6Macro()	1364
10.385.2.24 vtkSetMacro() [1/7]	1364
10.385.2.25 vtkSetMacro() [2/7]	1365

---

10.385.2.26	<a href="#">vtkSetMacro()</a> [3/7]	1365
10.385.2.27	<a href="#">vtkSetMacro()</a> [4/7]	1365
10.385.2.28	<a href="#">vtkSetMacro()</a> [5/7]	1365
10.385.2.29	<a href="#">vtkSetMacro()</a> [6/7]	1365
10.385.2.30	<a href="#">vtkSetMacro()</a> [7/7]	1365
10.385.2.31	<a href="#">vtkSetVector3Macro()</a> [1/2]	1366
10.385.2.32	<a href="#">vtkSetVector3Macro()</a> [2/2]	1366
10.385.2.33	<a href="#">vtkSetVector6Macro()</a>	1366
10.385.2.34	<a href="#">vtkTypeMacro()</a>	1366
10.386	<a href="#">vtkImageColorViewer Class Reference</a>	1367
10.386.1	<a href="#">Detailed Description</a>	1369
10.386.2	<a href="#">Member Enumeration Documentation</a>	1369
10.386.2.1	<a href="#">anonymous enum</a>	1369
10.386.3	<a href="#">Constructor &amp; Destructor Documentation</a>	1370
10.386.3.1	<a href="#">vtkImageColorViewer()</a>	1370
10.386.3.2	<a href="#">~vtkImageColorViewer()</a>	1370
10.386.4	<a href="#">Member Function Documentation</a>	1370
10.386.4.1	<a href="#">AddInput()</a>	1370
10.386.4.2	<a href="#">AddInputConnection()</a>	1370
10.386.4.3	<a href="#">GetColorLevel()</a>	1371
10.386.4.4	<a href="#">GetColorWindow()</a>	1371
10.386.4.5	<a href="#">GetInput()</a>	1371
10.386.4.6	<a href="#">GetOffScreenRendering()</a>	1371
10.386.4.7	<a href="#">GetOverlayVisibility()</a>	1371
10.386.4.8	<a href="#">GetPosition()</a>	1371
10.386.4.9	<a href="#">GetSize()</a>	1371
10.386.4.10	<a href="#">GetSliceMax()</a>	1372
10.386.4.11	<a href="#">GetSliceMin()</a>	1372
10.386.4.12	<a href="#">GetSliceRange()</a> [1/3]	1372
10.386.4.13	<a href="#">GetSliceRange()</a> [2/3]	1372
10.386.4.14	<a href="#">GetSliceRange()</a> [3/3]	1372
10.386.4.15	<a href="#">GetWindowName()</a>	1372
10.386.4.16	<a href="#">InstallPipeline()</a>	1372
10.386.4.17	<a href="#">New()</a>	1373
10.386.4.18	<a href="#">PrintSelf()</a>	1373
10.386.4.19	<a href="#">Render()</a>	1373
10.386.4.20	<a href="#">SetColorLevel()</a>	1373
10.386.4.21	<a href="#">SetColorWindow()</a>	1373
10.386.4.22	<a href="#">SetDisplayId()</a>	1374

---

10.386.4.23 SetInput()	1374
10.386.4.24 SetInputConnection()	1374
10.386.4.25 SetOffScreenRendering()	1374
10.386.4.26 SetOverlayVisibility()	1374
10.386.4.27 SetParentId()	1374
10.386.4.28 SetPosition() [1/2]	1375
10.386.4.29 SetPosition() [2/2]	1375
10.386.4.30 SetRenderer()	1375
10.386.4.31 SetRenderWindow()	1375
10.386.4.32 SetSize() [1/2]	1375
10.386.4.33 SetSize() [2/2]	1376
10.386.4.34 SetSlice()	1376
10.386.4.35 SetSliceOrientation()	1376
10.386.4.36 SetSliceOrientationToXY()	1376
10.386.4.37 SetSliceOrientationToXZ()	1376
10.386.4.38 SetSliceOrientationToYZ()	1376
10.386.4.39 SetupInteractor()	1377
10.386.4.40 SetWindowId()	1377
10.386.4.41 UnInstallPipeline()	1377
10.386.4.42 UpdateDisplayExtent()	1377
10.386.4.43 UpdateOrientation()	1377
10.386.4.44 VTK_LEGACY() [1/4]	1377
10.386.4.45 VTK_LEGACY() [2/4]	1378
10.386.4.46 VTK_LEGACY() [3/4]	1378
10.386.4.47 VTK_LEGACY() [4/4]	1378
10.386.4.48 vtkBooleanMacro()	1378
10.386.4.49 vtkGetMacro() [1/2]	1378
10.386.4.50 vtkGetMacro() [2/2]	1378
10.386.4.51 vtkGetObjectMacro() [1/5]	1379
10.386.4.52 vtkGetObjectMacro() [2/5]	1379
10.386.4.53 vtkGetObjectMacro() [3/5]	1379
10.386.4.54 vtkGetObjectMacro() [4/5]	1379
10.386.4.55 vtkGetObjectMacro() [5/5]	1379
10.386.4.56 vtkTypeMacro()	1379
10.386.5 Friends And Related Function Documentation	1380
10.386.5.1 vtkImageColorViewerCallback	1380
10.386.6 Member Data Documentation	1380
10.386.6.1 FirstRender	1380
10.386.6.2 ImageActor	1380



---

10.386.6.3 Interactor	1380
10.386.6.4 InteractorStyle	1380
10.386.6.5 OverlayImageActor	1380
10.386.6.6 Renderer	1381
10.386.6.7 RenderWindow	1381
10.386.6.8 Slice	1381
10.386.6.9 SliceOrientation	1381
10.386.6.10 WindowLevel	1381
10.387 vtkImageMapToColors16 Class Reference	1382
10.387.1 Constructor & Destructor Documentation	1383
10.387.1.1 vtkImageMapToColors16()	1383
10.387.1.2 ~vtkImageMapToColors16()	1383
10.387.2 Member Function Documentation	1384
10.387.2.1 GetMTime()	1384
10.387.2.2 New()	1384
10.387.2.3 PrintSelf()	1384
10.387.2.4 RequestData()	1384
10.387.2.5 RequestInformation()	1384
10.387.2.6 SetLookupTable()	1385
10.387.2.7 SetOutputFormatToLuminance()	1385
10.387.2.8 SetOutputFormatToLuminanceAlpha()	1385
10.387.2.9 SetOutputFormatToRGB()	1385
10.387.2.10 SetOutputFormatToRGBA()	1385
10.387.2.11 ThreadedRequestData()	1385
10.387.2.12 vtkBooleanMacro()	1386
10.387.2.13 vtkGetMacro() [1/3]	1386
10.387.2.14 vtkGetMacro() [2/3]	1386
10.387.2.15 vtkGetMacro() [3/3]	1386
10.387.2.16 vtkGetObjectMacro()	1386
10.387.2.17 vtkSetMacro() [1/3]	1386
10.387.2.18 vtkSetMacro() [2/3]	1387
10.387.2.19 vtkSetMacro() [3/3]	1387
10.387.2.20 vtkTypeMacro()	1387
10.387.3 Member Data Documentation	1387
10.387.3.1 ActiveComponent	1387
10.387.3.2 DataWasPassed	1387
10.387.3.3 LookupTable	1387
10.387.3.4 OutputFormat	1388
10.387.3.5 PassAlphaToOutput	1388

---

10.388	<a href="#">vtkImageMapToWindowLevelColors2 Class Reference</a>	1388
10.388.1	<a href="#">Constructor &amp; Destructor Documentation</a>	1389
10.388.1.1	<a href="#">vtkImageMapToWindowLevelColors2()</a>	1389
10.388.1.2	<a href="#">~vtkImageMapToWindowLevelColors2()</a>	1389
10.388.2	<a href="#">Member Function Documentation</a>	1390
10.388.2.1	<a href="#">New()</a>	1390
10.388.2.2	<a href="#">PrintSelf()</a>	1390
10.388.2.3	<a href="#">RequestData()</a>	1390
10.388.2.4	<a href="#">RequestInformation()</a>	1390
10.388.2.5	<a href="#">ThreadedRequestData()</a>	1390
10.388.2.6	<a href="#">vtkGetMacro() [1/2]</a>	1391
10.388.2.7	<a href="#">vtkGetMacro() [2/2]</a>	1391
10.388.2.8	<a href="#">vtkSetMacro() [1/2]</a>	1391
10.388.2.9	<a href="#">vtkSetMacro() [2/2]</a>	1391
10.388.2.10	<a href="#">vtkTypeMacro()</a>	1391
10.388.3	<a href="#">Member Data Documentation</a>	1391
10.388.3.1	<a href="#">Level</a>	1392
10.388.3.2	<a href="#">Window</a>	1392
10.389	<a href="#">vtkImagePlanarComponentsToComponents Class Reference</a>	1392
10.389.1	<a href="#">Constructor &amp; Destructor Documentation</a>	1393
10.389.1.1	<a href="#">vtkImagePlanarComponentsToComponents()</a>	1393
10.389.1.2	<a href="#">~vtkImagePlanarComponentsToComponents()</a>	1393
10.389.2	<a href="#">Member Function Documentation</a>	1393
10.389.2.1	<a href="#">New()</a>	1393
10.389.2.2	<a href="#">PrintSelf()</a>	1394
10.389.2.3	<a href="#">RequestData()</a>	1394
10.389.2.4	<a href="#">vtkTypeMacro()</a>	1394
10.390	<a href="#">vtkImageRGBToYBR Class Reference</a>	1394
10.390.1	<a href="#">Constructor &amp; Destructor Documentation</a>	1395
10.390.1.1	<a href="#">vtkImageRGBToYBR()</a>	1395
10.390.1.2	<a href="#">~vtkImageRGBToYBR()</a>	1395
10.390.2	<a href="#">Member Function Documentation</a>	1396
10.390.2.1	<a href="#">New()</a>	1396
10.390.2.2	<a href="#">PrintSelf()</a>	1396
10.390.2.3	<a href="#">ThreadedExecute()</a>	1396
10.390.2.4	<a href="#">vtkTypeMacro()</a>	1396
10.391	<a href="#">vtkImageYBRToRGB Class Reference</a>	1397
10.391.1	<a href="#">Constructor &amp; Destructor Documentation</a>	1398
10.391.1.1	<a href="#">vtkImageYBRToRGB()</a>	1398

---

10.391.1.2 ~vtkImageYBRToRGB()	1398
10.391.2 Member Function Documentation	1398
10.391.2.1 New()	1398
10.391.2.2 PrintSelf()	1398
10.391.2.3 ThreadedExecute()	1399
10.391.2.4 vtkTypeMacro()	1399
10.392 vtkLookupTable16 Class Reference	1399
10.392.1 Constructor & Destructor Documentation	1400
10.392.1.1 vtkLookupTable16()	1401
10.392.1.2 ~vtkLookupTable16()	1401
10.392.2 Member Function Documentation	1401
10.392.2.1 Build()	1401
10.392.2.2 GetPointer()	1401
10.392.2.3 MapScalarsThroughTable2()	1401
10.392.2.4 New()	1402
10.392.2.5 PrintSelf()	1402
10.392.2.6 SetNumberOfTableValues()	1402
10.392.2.7 vtkTypeMacro()	1402
10.392.2.8 WritePointer()	1402
10.392.3 Member Data Documentation	1402
10.392.3.1 Table16	1403
10.393 vtkRTStructSetProperties Class Reference	1403
10.393.1 Detailed Description	1405
10.393.2 Constructor & Destructor Documentation	1405
10.393.2.1 vtkRTStructSetProperties()	1405
10.393.2.2 ~vtkRTStructSetProperties()	1405
10.393.3 Member Function Documentation	1405
10.393.3.1 AddContourReferencedFrameOfReference()	1406
10.393.3.2 AddReferencedFrameOfReference()	1406
10.393.3.3 AddStructureSetROI()	1406
10.393.3.4 AddStructureSetROIObservation()	1406
10.393.3.5 Clear()	1406
10.393.3.6 DeepCopy()	1407
10.393.3.7 GetContourReferencedFrameOfReferenceClassUID()	1407
10.393.3.8 GetContourReferencedFrameOfReferenceInstanceUID()	1407
10.393.3.9 GetNumberOfContourReferencedFrameOfReferences() [1/2]	1407
10.393.3.10 GetNumberOfContourReferencedFrameOfReferences() [2/2]	1407
10.393.3.11 GetNumberOfReferencedFrameOfReferences()	1407
10.393.3.12 GetNumberOfStructureSetROIs()	1408

---

10.393.3.13	GetReferencedFrameOfReferenceClassUID()	1408
10.393.3.14	GetReferencedFrameOfReferenceInstanceUID()	1408
10.393.3.15	GetStructureSetObservationNumber()	1408
10.393.3.16	GetStructureSetROIDescription()	1408
10.393.3.17	GetStructureSetROIGenerationAlgorithm()	1408
10.393.3.18	GetStructureSetROIName()	1409
10.393.3.19	GetStructureSetROINumber()	1409
10.393.3.20	GetStructureSetROIObservationLabel()	1409
10.393.3.21	GetStructureSetROIRefFrameRefUID()	1409
10.393.3.22	GetStructureSetRTROIInterpretedType()	1409
10.393.3.23	New()	1409
10.393.3.24	PrintSelf()	1410
10.393.3.25	vtkGetStringMacro() [1/9]	1410
10.393.3.26	vtkGetStringMacro() [2/9]	1410
10.393.3.27	vtkGetStringMacro() [3/9]	1410
10.393.3.28	vtkGetStringMacro() [4/9]	1410
10.393.3.29	vtkGetStringMacro() [5/9]	1410
10.393.3.30	vtkGetStringMacro() [6/9]	1411
10.393.3.31	vtkGetStringMacro() [7/9]	1411
10.393.3.32	vtkGetStringMacro() [8/9]	1411
10.393.3.33	vtkGetStringMacro() [9/9]	1411
10.393.3.34	vtkSetStringMacro() [1/9]	1411
10.393.3.35	vtkSetStringMacro() [2/9]	1411
10.393.3.36	vtkSetStringMacro() [3/9]	1412
10.393.3.37	vtkSetStringMacro() [4/9]	1412
10.393.3.38	vtkSetStringMacro() [5/9]	1412
10.393.3.39	vtkSetStringMacro() [6/9]	1412
10.393.3.40	vtkSetStringMacro() [7/9]	1412
10.393.3.41	vtkSetStringMacro() [8/9]	1412
10.393.3.42	vtkSetStringMacro() [9/9]	1413
10.393.3.43	vtkTypeMacro()	1413
10.393.4	Member Data Documentation	1413
10.393.4.1	Internals	1413
10.393.4.2	ReferenceFrameOfReferenceUID	1413
10.393.4.3	ReferenceSeriesInstanceUID	1413
10.393.4.4	SeriesInstanceUID	1413
10.393.4.5	SOPInstanceUID	1414
10.393.4.6	StructureSetDate	1414
10.393.4.7	StructureSetLabel	1414

---

10.393.4.8 StructureSetName . . . . .	1414
10.393.4.9 StructureSetTime . . . . .	1414
10.393.4.10 StudyInstanceUID . . . . .	1414
10.394 gdcM::Waveform Class Reference . . . . .	1414
10.394.1 Detailed Description . . . . .	1415
10.394.2 Constructor & Destructor Documentation . . . . .	1415
10.394.2.1 Waveform() . . . . .	1415
10.395 gdcM::WLMFindQuery Class Reference . . . . .	1415
10.395.1 Detailed Description . . . . .	1416
10.395.2 Constructor & Destructor Documentation . . . . .	1416
10.395.2.1 WLMFindQuery() . . . . .	1417
10.395.3 Member Function Documentation . . . . .	1417
10.395.3.1 GetAbstractSyntaxUID() . . . . .	1417
10.395.3.2 GetTagListByLevel() . . . . .	1417
10.395.3.3 GetValidDataSet() . . . . .	1417
10.395.3.4 InitializeDataSet() . . . . .	1417
10.395.3.5 ValidateQuery() . . . . .	1418
10.395.4 Friends And Related Function Documentation . . . . .	1418
10.395.4.1 QueryFactory . . . . .	1418
10.396 gdcM::Writer Class Reference . . . . .	1418
10.396.1 Detailed Description . . . . .	1420
10.396.2 Constructor & Destructor Documentation . . . . .	1421
10.396.2.1 Writer() . . . . .	1421
10.396.2.2 ~Writer() . . . . .	1421
10.396.3 Member Function Documentation . . . . .	1421
10.396.3.1 CheckFileMetaInformationOff() . . . . .	1421
10.396.3.2 CheckFileMetaInformationOn() . . . . .	1421
10.396.3.3 GetCheckFileMetaInformation() . . . . .	1421
10.396.3.4 GetFile() . . . . .	1422
10.396.3.5 GetStreamPtr() . . . . .	1422
10.396.3.6 SetCheckFileMetaInformation() . . . . .	1422
10.396.3.7 SetFile() . . . . .	1422
10.396.3.8 SetFileName() . . . . .	1423
10.396.3.9 SetStream() . . . . .	1423
10.396.3.10 SetWriteDataSetOnly() . . . . .	1423
10.396.3.11 Write() . . . . .	1423
10.396.4 Friends And Related Function Documentation . . . . .	1424
10.396.4.1 StreamImageWriter . . . . .	1424
10.396.5 Member Data Documentation . . . . .	1424

---

10.396.5.1 Ofstream	1424
10.396.5.2 Stream	1424
10.397 gdc::XMLDictReader Class Reference	1424
10.397.1 Detailed Description	1425
10.397.2 Constructor & Destructor Documentation	1425
10.397.2.1 XMLDictReader()	1425
10.397.2.2 ~XMLDictReader()	1426
10.397.3 Member Function Documentation	1426
10.397.3.1 CharacterDataHandler()	1426
10.397.3.2 EndElement()	1426
10.397.3.3 GetDict()	1426
10.397.3.4 HandleDescription()	1426
10.397.3.5 HandleEntry()	1427
10.397.3.6 StartElement()	1427
10.398 gdc::XMLPrinter Class Reference	1427
10.398.1 Member Enumeration Documentation	1428
10.398.1.1 PrintStyles	1428
10.398.2 Constructor & Destructor Documentation	1429
10.398.2.1 XMLPrinter()	1429
10.398.2.2 ~XMLPrinter()	1429
10.398.3 Member Function Documentation	1429
10.398.3.1 GetPrintStyle()	1429
10.398.3.2 HandleBulkData()	1429
10.398.3.3 Print()	1429
10.398.3.4 PrintDataElement()	1430
10.398.3.5 PrintDataSet()	1430
10.398.3.6 PrintSQ()	1430
10.398.3.7 SetFile()	1430
10.398.3.8 SetStyle()	1430
10.398.4 Member Data Documentation	1430
10.398.4.1 F	1431
10.398.4.2 PrintStyle	1431
10.399 gdc::XMLPrivateDictReader Class Reference	1431
10.399.1 Detailed Description	1432
10.399.2 Constructor & Destructor Documentation	1432
10.399.2.1 XMLPrivateDictReader()	1432
10.399.2.2 ~XMLPrivateDictReader()	1432
10.399.3 Member Function Documentation	1432
10.399.3.1 CharacterDataHandler()	1433

---

10.399.3.2 EndElement()	1433
10.399.3.3 GetPrivateDict()	1433
10.399.3.4 HandleDescription()	1433
10.399.3.5 HandleEntry()	1433
10.399.3.6 StartElement()	1433
<b>11 File Documentation</b>	<b>1435</b>
11.1 gdcmAAbortPDU.h File Reference	1435
11.2 gdcmAAssociateACPDU.h File Reference	1436
11.3 gdcmAAssociateRJPDU.h File Reference	1436
11.4 gdcmAAssociateRQPDU.h File Reference	1437
11.5 gdcmAbstractSyntax.h File Reference	1438
11.6 gdcmAnonymizeEvent.h File Reference	1439
11.7 gdcmAnonymizer.h File Reference	1440
11.8 gdcmApplicationContext.h File Reference	1441
11.9 gdcmApplicationEntity.h File Reference	1442
11.10 gdcmAReleaseRPPDU.h File Reference	1442
11.11 gdcmAReleaseRQPDU.h File Reference	1443
11.12 gdcmARTIMTimer.h File Reference	1444
11.13 gdcmASN1.h File Reference	1445
11.14 gdcmAsynchronousOperationsWindowSub.h File Reference	1446
11.15 gdcmAttribute.h File Reference	1446
11.16 gdcmAudioCodec.h File Reference	1448
11.17 gdcmBase64.h File Reference	1449
11.18 gdcmBaseCompositeMessage.h File Reference	1449
11.19 gdcmBaseNormalizedMessage.h File Reference	1450
11.20 gdcmBasePDU.h File Reference	1451
11.21 gdcmBaseQuery.h File Reference	1452
11.22 gdcmBaseRootQuery.h File Reference	1453
11.23 gdcmBasicOffsetTable.h File Reference	1454
11.24 gdcmBitmap.h File Reference	1455
11.25 gdcmBitmapToBitmapFilter.h File Reference	1456
11.26 gdcmBoxRegion.h File Reference	1457
11.27 gdcmByteBuffer.h File Reference	1457
11.28 gdcmByteSwap.h File Reference	1459
11.29 gdcmByteSwapFilter.h File Reference	1459
11.30 gdcmByteValue.h File Reference	1460
11.31 gdcmCAPICryptoFactory.h File Reference	1461
11.32 gdcmCAPICryptographicMessageSyntax.h File Reference	1462

---

11.33 gdcxCEchoMessages.h File Reference	1462
11.34 gdcMCFindMessages.h File Reference	1463
11.35 gdcMCMoveMessages.h File Reference	1464
11.36 gdcMCodec.h File Reference	1465
11.37 gdcMCoder.h File Reference	1466
11.38 gdcMCodeString.h File Reference	1468
11.39 gdcMCommand.h File Reference	1469
11.40 gdcMCommandDataSet.h File Reference	1470
11.41 gdcMCompositeMessageFactory.h File Reference	1471
11.42 gdcMCompositeNetworkFunctions.h File Reference	1471
11.43 gdcMConstCharWrapper.h File Reference	1472
11.44 gdcMCP246ExplicitDataElement.h File Reference	1472
11.45 gdcMCryptoFactory.h File Reference	1473
11.46 gdcMCryptographicMessageSyntax.h File Reference	1474
11.47 gdcMCSAElement.h File Reference	1475
11.48 gdcMCSAHeader.h File Reference	1476
11.49 gdcMCSAHeaderDict.h File Reference	1477
11.50 gdcMCSAHeaderDictEntry.h File Reference	1478
11.51 gdcMCSStoreMessages.h File Reference	1479
11.52 gdcMCurve.h File Reference	1480
11.53 gdcMDataElement.h File Reference	1481
11.54 gdcMDataEvent.h File Reference	1483
11.55 gdcMDataSet.h File Reference	1484
11.56 gdcMDataSetEvent.h File Reference	1485
11.57 gdcMDataSetHelper.h File Reference	1485
11.58 gdcMDecoder.h File Reference	1486
11.59 gdcMDefinedTerms.h File Reference	1488
11.60 gdcMDeflateStream.h File Reference	1488
11.61 gdcMDefs.h File Reference	1489
11.62 gdcMDeltaEncodingCodec.h File Reference	1490
11.63 gdcMDICOMDIR.h File Reference	1491
11.64 gdcMDICOMDIRGenerator.h File Reference	1492
11.65 gdcMDict.h File Reference	1492
11.66 gdcMDictConverter.h File Reference	1494
11.67 gdcMDictEntry.h File Reference	1494
11.68 gdcMDictPrinter.h File Reference	1496
11.69 gdcMDicts.h File Reference	1496
11.70 gdcMDIMSE.h File Reference	1498
11.71 gdcMDirectionCosines.h File Reference	1498



---

11.72 gdcDirectory.h File Reference . . . . .	1499
11.73 gdcDirectoryHelper.h File Reference . . . . .	1500
11.74 gdcDummyValueGenerator.h File Reference . . . . .	1501
11.75 gdcDumper.h File Reference . . . . .	1502
11.76 gdcElement.h File Reference . . . . .	1502
11.77 gdcEmptyMaskGenerator.h File Reference . . . . .	1504
11.78 gdcEncapsulatedDocument.h File Reference . . . . .	1505
11.79 gdcEnumeratedValues.h File Reference . . . . .	1505
11.80 gdcEquipmentManufacturer.h File Reference . . . . .	1506
11.81 gdcEvent.h File Reference . . . . .	1507
11.81.1 Macro Definition Documentation . . . . .	1508
11.81.1.1 gdcEventMacro . . . . .	1508
11.82 gdcException.h File Reference . . . . .	1508
11.83 gdcExplicitDataElement.h File Reference . . . . .	1509
11.84 gdcExplicitImplicitDataElement.h File Reference . . . . .	1510
11.85 gdcFiducials.h File Reference . . . . .	1511
11.86 gdcFile.h File Reference . . . . .	1511
11.87 gdcFileAnonymizer.h File Reference . . . . .	1513
11.88 gdcFileChangeTransferSyntax.h File Reference . . . . .	1513
11.89 gdcFileDecompressLookupTable.h File Reference . . . . .	1514
11.90 gdcFileDerivation.h File Reference . . . . .	1515
11.91 gdcFileExplicitFilter.h File Reference . . . . .	1516
11.92 gdcFileMetaInformation.h File Reference . . . . .	1517
11.93 gdcFilename.h File Reference . . . . .	1518
11.94 gdcFileNameEvent.h File Reference . . . . .	1518
11.95 gdcFilenameGenerator.h File Reference . . . . .	1519
11.96 gdcFileSet.h File Reference . . . . .	1520
11.97 gdcFileStreamer.h File Reference . . . . .	1521
11.98 gdcFindPatientRootQuery.h File Reference . . . . .	1522
11.99 gdcFindStudyRootQuery.h File Reference . . . . .	1523
11.100 gdcFragment.h File Reference . . . . .	1523
11.101 gdcGlobal.h File Reference . . . . .	1525
11.102 gdcGroupDict.h File Reference . . . . .	1526
11.103 gdcIconImage.h File Reference . . . . .	1526
11.104 gdcIconImageFilter.h File Reference . . . . .	1527
11.105 gdcIconImageGenerator.h File Reference . . . . .	1528
11.106 gdcImage.h File Reference . . . . .	1529
11.107 gdcImageApplyLookupTable.h File Reference . . . . .	1530
11.108 gdcImageChangePhotometricInterpretation.h File Reference . . . . .	1531

---

11.109 gdcmlImageChangePlanarConfiguration.h File Reference	1532
11.110 gdcmlImageChangeTransferSyntax.h File Reference	1532
11.111 gdcmlImageCodec.h File Reference	1533
11.112 gdcmlImageConverter.h File Reference	1534
11.113 gdcmlImageFragmentSplitter.h File Reference	1535
11.114 gdcmlImageHelper.h File Reference	1536
11.115 gdcmlImageReader.h File Reference	1537
11.116 gdcmlImageRegionReader.h File Reference	1538
11.117 gdcmlImageToImageFilter.h File Reference	1538
11.118 gdcmlImageWriter.h File Reference	1539
11.119 gdcmlImplementationClassUIDSub.h File Reference	1540
11.120 gdcmlImplementationUIDSub.h File Reference	1541
11.121 gdcmlImplementationVersionNameSub.h File Reference	1542
11.122 gdcmlImplicitDataElement.h File Reference	1543
11.123 gdcmlIOD.h File Reference	1544
11.124 gdcmlIODEntry.h File Reference	1545
11.125 gdcmlIODs.h File Reference	1547
11.126 gdcmlIPPSorter.h File Reference	1548
11.127 gdcmlItem.h File Reference	1549
11.128 gdcmlJPEG12Codec.h File Reference	1551
11.129 gdcmlJPEG16Codec.h File Reference	1551
11.130 gdcmlJPEG2000Codec.h File Reference	1552
11.131 gdcmlJPEG8Codec.h File Reference	1553
11.132 gdcmlJPEGCodec.h File Reference	1554
11.133 gdcmlJPEGLSCodec.h File Reference	1555
11.134 gdcmlJSON.h File Reference	1555
11.135 gdcmlKAKADUCodec.h File Reference	1556
11.136 gdcmlLegacyMacro.h File Reference	1557
11.136.1 Macro Definition Documentation	1557
11.136.1.1 GDCM_LEGACY	1558
11.136.1.2 GDCM_LEGACY_BODY	1558
11.136.1.3 GDCM_LEGACY_REPLACED_BODY	1558
11.136.1.4 GDCM_NOOP_STATEMENT	1558
11.137 gdcmlLO.h File Reference	1559
11.138 gdcmlLookupTable.h File Reference	1559
11.139 gdcmlMacro.h File Reference	1560
11.140 gdcmlMacroEntry.h File Reference	1562
11.140.1 Macro Definition Documentation	1563
11.140.1.1 GDCMMACROENTRY_H	1563

---

11.141 gdcMacros.h File Reference . . . . .	1564
11.142 gdcMaximumLengthSub.h File Reference . . . . .	1565
11.143 gdcMD5.h File Reference . . . . .	1567
11.144 gdcMediaStorage.h File Reference . . . . .	1567
11.145 gdcMeshPrimitive.h File Reference . . . . .	1569
11.146 gdcModalityPerformedProcedureStepCreateQuery.h File Reference . . . . .	1570
11.147 gdcModalityPerformedProcedureStepSetQuery.h File Reference . . . . .	1571
11.148 gdcModule.h File Reference . . . . .	1571
11.149 gdcModuleEntry.h File Reference . . . . .	1573
11.150 gdcModules.h File Reference . . . . .	1575
11.151 gdcMovePatientRootQuery.h File Reference . . . . .	1576
11.152 gdcMoveStudyRootQuery.h File Reference . . . . .	1577
11.153 gdcMrProtocol.h File Reference . . . . .	1577
11.154 gdcNActionMessages.h File Reference . . . . .	1579
11.155 gdcNCreateMessages.h File Reference . . . . .	1579
11.156 gdcNDeleteMessages.h File Reference . . . . .	1580
11.157 gdcNestedModuleEntries.h File Reference . . . . .	1581
11.158 gdcNetworkEvents.h File Reference . . . . .	1582
11.159 gdcNetworkStateID.h File Reference . . . . .	1583
11.160 gdcNEventReportMessages.h File Reference . . . . .	1584
11.161 gdcNGetMessages.h File Reference . . . . .	1585
11.162 gdcNormalizedMessageFactory.h File Reference . . . . .	1585
11.163 gdcNormalizedNetworkFunctions.h File Reference . . . . .	1586
11.164 gdcNSetMessages.h File Reference . . . . .	1587
11.165 gdcObject.h File Reference . . . . .	1587
11.166 gdcOpenSSLCryptoFactory.h File Reference . . . . .	1589
11.167 gdcOpenSSLCryptographicMessageSyntax.h File Reference . . . . .	1589
11.168 gdcOpenSSLP7CryptoFactory.h File Reference . . . . .	1591
11.169 gdcOpenSSLP7CryptographicMessageSyntax.h File Reference . . . . .	1591
11.170 gdcOrientation.h File Reference . . . . .	1593
11.171 gdcOverlay.h File Reference . . . . .	1593
11.172 gdcParseException.h File Reference . . . . .	1594
11.173 gdcParser.h File Reference . . . . .	1596
11.174 gdcPatient.h File Reference . . . . .	1596
11.175 gdcPDataTFPDU.h File Reference . . . . .	1597
11.176 gdcPDBElement.h File Reference . . . . .	1598
11.177 gdcPDBHeader.h File Reference . . . . .	1599
11.178 gdcPDFCodec.h File Reference . . . . .	1600
11.179 gdcPDUFactory.h File Reference . . . . .	1601

11.180 gdcmlPersonName.h File Reference . . . . .	1601
11.181 gdcmlPGXCodec.h File Reference . . . . .	1602
11.182 gdcmlPhotometricInterpretation.h File Reference . . . . .	1603
11.183 gdcmlPixelFormat.h File Reference . . . . .	1604
11.184 gdcmlPixmap.h File Reference . . . . .	1605
11.185 gdcmlPixmapReader.h File Reference . . . . .	1606
11.186 gdcmlPixmapToPixmapFilter.h File Reference . . . . .	1607
11.187 gdcmlPixmapWriter.h File Reference . . . . .	1607
11.188 gdcmlPNMCodec.h File Reference . . . . .	1609
11.189 gdcmlPreamble.h File Reference . . . . .	1609
11.190 gdcmlPresentationContext.h File Reference . . . . .	1611
11.191 gdcmlPresentationContextAC.h File Reference . . . . .	1612
11.192 gdcmlPresentationContextGenerator.h File Reference . . . . .	1613
11.193 gdcmlPresentationContextRQ.h File Reference . . . . .	1613
11.194 gdcmlPresentationDataValue.h File Reference . . . . .	1614
11.195 gdcmlPrinter.h File Reference . . . . .	1615
11.196 gdcmlPrivateTag.h File Reference . . . . .	1617
11.197 gdcmlProgressEvent.h File Reference . . . . .	1618
11.198 gdcmlPVRGCodec.h File Reference . . . . .	1619
11.199 gdcmlPythonFilter.h File Reference . . . . .	1619
11.200 gdcmlQueryBase.h File Reference . . . . .	1620
11.201 gdcmlQueryFactory.h File Reference . . . . .	1621
11.202 gdcmlQueryImage.h File Reference . . . . .	1622
11.203 gdcmlQueryPatient.h File Reference . . . . .	1623
11.204 gdcmlQuerySeries.h File Reference . . . . .	1624
11.205 gdcmlQueryStudy.h File Reference . . . . .	1625
11.206 gdcmlRAWCodec.h File Reference . . . . .	1626
11.207 gdcmlReader.h File Reference . . . . .	1626
11.208 gdcmlRegion.h File Reference . . . . .	1628
11.209 gdcmlRescaler.h File Reference . . . . .	1629
11.210 gdcmlRLECodec.h File Reference . . . . .	1630
11.211 gdcmlRoleSelectionSub.h File Reference . . . . .	1630
11.212 gdcmlScanner.h File Reference . . . . .	1631
11.213 gdcmlSegment.h File Reference . . . . .	1632
11.214 gdcmlSegmentedPaletteColorLookupTable.h File Reference . . . . .	1633
11.215 gdcmlSegmentHelper.h File Reference . . . . .	1634
11.216 gdcmlSegmentReader.h File Reference . . . . .	1635
11.217 gdcmlSegmentWriter.h File Reference . . . . .	1636
11.218 gdcmlSequenceOfFragments.h File Reference . . . . .	1637

---

11.219 gdcSequenceOfItems.h File Reference	1638
11.220 gdcSerieHelper.h File Reference	1638
11.221 gdcSeries.h File Reference	1640
11.222 gdcServiceClassApplicationInformation.h File Reference	1641
11.223 gdcServiceClassUser.h File Reference	1642
11.224 gdcSHA1.h File Reference	1642
11.225 gdcSimpleSubjectWatcher.h File Reference	1643
11.226 gdcSmartPointer.h File Reference	1644
11.227 gdcSOPClassExtendedNegociationSub.h File Reference	1645
11.228 gdcSOPClassUIDToIOD.h File Reference	1646
11.229 gdcSorter.h File Reference	1647
11.230 gdcSpacing.h File Reference	1649
11.231 gdcSpectroscopy.h File Reference	1649
11.232 gdcSplitMosaicFilter.h File Reference	1650
11.233 gdcStaticAssert.h File Reference	1651
11.233.1 Macro Definition Documentation	1651
11.233.1.1 GDCM_DO_JOIN	1652
11.233.1.2 GDCM_DO_JOIN2	1652
11.233.1.3 GDCM_JOIN	1652
11.233.1.4 GDCM_STATIC_ASSERT	1652
11.234 gdcStreamImageReader.h File Reference	1653
11.235 gdcStreamImageWriter.h File Reference	1653
11.236 gdcStrictScanner.h File Reference	1654
11.237 gdcString.h File Reference	1655
11.238 gdcStringFilter.h File Reference	1656
11.239 gdcStudy.h File Reference	1657
11.240 gdcSubject.h File Reference	1658
11.241 gdcSurface.h File Reference	1659
11.242 gdcSurfaceHelper.h File Reference	1660
11.243 gdcSurfaceReader.h File Reference	1661
11.244 gdcSurfaceWriter.h File Reference	1662
11.245 gdcSwapCode.h File Reference	1662
11.246 gdcSwapper.h File Reference	1664
11.247 gdcSystem.h File Reference	1665
11.248 gdcTable.h File Reference	1665
11.249 gdcTableEntry.h File Reference	1666
11.250 gdcTableReader.h File Reference	1668
11.251 gdcTag.h File Reference	1669
11.252 gdcTagPath.h File Reference	1670

---

11.253 gdcTagToVR.h File Reference . . . . .	1670
11.254 gdcTerminal.h File Reference . . . . .	1671
11.255 gdcTestDriver.h File Reference . . . . .	1672
11.256 gdcTesting.h File Reference . . . . .	1673
11.257 gdcTrace.h File Reference . . . . .	1674
11.257.1 Macro Definition Documentation . . . . .	1675
11.257.1.1 GDCM_FUNCTION . . . . .	1675
11.257.1.2 gdcAssertAlwaysMacro . . . . .	1675
11.257.1.3 gdcAssertMacro . . . . .	1675
11.257.1.4 gdcDebugMacro . . . . .	1676
11.257.1.5 gdcErrorMacro . . . . .	1676
11.257.1.6 gdcWarningMacro . . . . .	1678
11.258 gdcTransferSyntax.h File Reference . . . . .	1678
11.259 gdcTransferSyntaxSub.h File Reference . . . . .	1680
11.260 gdcType.h File Reference . . . . .	1681
11.261 gdcTypes.h File Reference . . . . .	1682
11.262 gdcUIDGenerator.h File Reference . . . . .	1682
11.263 gdcUIDs.h File Reference . . . . .	1683
11.264 gdcULAction.h File Reference . . . . .	1684
11.265 gdcULActionAA.h File Reference . . . . .	1685
11.266 gdcULActionAE.h File Reference . . . . .	1685
11.267 gdcULActionAR.h File Reference . . . . .	1686
11.268 gdcULActionDT.h File Reference . . . . .	1687
11.269 gdcULBasicCallback.h File Reference . . . . .	1687
11.270 gdcULConnection.h File Reference . . . . .	1688
11.271 gdcULConnectionCallback.h File Reference . . . . .	1689
11.272 gdcULConnectionInfo.h File Reference . . . . .	1690
11.273 gdcULConnectionManager.h File Reference . . . . .	1691
11.274 gdcULEvent.h File Reference . . . . .	1692
11.275 gdcULTransitionTable.h File Reference . . . . .	1693
11.276 gdcULWritingCallback.h File Reference . . . . .	1694
11.277 gdcUNExplicitDataElement.h File Reference . . . . .	1695
11.278 gdcUNExplicitImplicitDataElement.h File Reference . . . . .	1695
11.279 gdcUnpacker12Bits.h File Reference . . . . .	1696
11.280 gdcUsage.h File Reference . . . . .	1697
11.281 gdcUserInformation.h File Reference . . . . .	1699
11.282 gdcUUIDGenerator.h File Reference . . . . .	1700
11.283 gdcValidate.h File Reference . . . . .	1700
11.284 gdcValue.h File Reference . . . . .	1701

---

11.285 gdcmlValueIO.h File Reference	1702
11.286 gdcmlVersion.h File Reference	1702
11.287 gdcmlVL.h File Reference	1703
11.288 gdcmlVM.h File Reference	1704
11.288.1 Macro Definition Documentation	1705
11.288.1.1 TYPETOLENGTH	1705
11.289 gdcmlVR.h File Reference	1705
11.289.1 Macro Definition Documentation	1707
11.289.1.1 TYPETOENCODING	1707
11.289.1.2 VRTypeTemplateCase	1707
11.290 gdcmlVR16ExplicitDataElement.h File Reference	1707
11.291 gdcmlWaveform.h File Reference	1708
11.292 gdcmlWin32.h File Reference	1708
11.292.1 Macro Definition Documentation	1709
11.292.1.1 GDCM_EXPORT	1709
11.293 gdcmlWLMFindQuery.h File Reference	1709
11.294 gdcmlWriter.h File Reference	1710
11.295 gdcmlXMLDictReader.h File Reference	1711
11.296 gdcmlXMLPrinter.h File Reference	1711
11.297 gdcmlXMLPrivateDictReader.h File Reference	1712
11.298 README.txt File Reference	1713
11.299 TestsList.txt File Reference	1713
11.300 vtkGDCMImageReader.h File Reference	1713
11.300.1 Macro Definition Documentation	1714
11.300.1.1 VTK_CMYK	1714
11.300.1.2 VTK_INVERSE_LUMINANCE	1714
11.300.1.3 VTK_LOOKUP_TABLE	1714
11.300.1.4 VTK_YBR	1714
11.301 vtkGDCMImageReader2.h File Reference	1715
11.301.1 Macro Definition Documentation	1715
11.301.1.1 VTK_CMYK	1715
11.301.1.2 VTK_INVERSE_LUMINANCE	1716
11.301.1.3 VTK_LOOKUP_TABLE	1716
11.301.1.4 VTK_YBR	1716
11.302 vtkGDCMImageWriter.h File Reference	1716
11.303 vtkGDCMMedicalImageProperties.h File Reference	1717
11.304 vtkGDCMPolyDataReader.h File Reference	1717
11.305 vtkGDCMPolyDataWriter.h File Reference	1718
11.306 vtkGDCMTesting.h File Reference	1719

---

11.307	<a href="#">vtkGDCMThreadedImageReader.h File Reference</a>	1719
11.308	<a href="#">vtkGDCMThreadedImageReader2.h File Reference</a>	1720
11.309	<a href="#">vtkImageColorViewer.h File Reference</a>	1720
11.310	<a href="#">vtkImageMapToColors16.h File Reference</a>	1721
11.311	<a href="#">vtkImageMapToWindowLevelColors2.h File Reference</a>	1721
11.312	<a href="#">vtkImagePlanarComponentsToComponents.h File Reference</a>	1722
11.313	<a href="#">vtkImageRGBToYBR.h File Reference</a>	1722
11.314	<a href="#">vtkImageYBRToRGB.h File Reference</a>	1723
11.315	<a href="#">vtkLookupTable16.h File Reference</a>	1723
11.316	<a href="#">vtkRTStructSetProperties.h File Reference</a>	1724
<b>12</b>	<b>Example Documentation</b>	<b>1725</b>
12.1	<a href="#">TestByteSwap.cxx</a>	1725
12.2	<a href="#">PatchFile.cxx</a>	1727
12.3	<a href="#">SimplePrint.cs</a>	1728
12.4	<a href="#">TestReader.cxx</a>	1729
12.5	<a href="#">TestReader.py</a>	1730
12.6	<a href="#">DecompressJPEGFile.cs</a>	1731
12.7	<a href="#">ManipulateFile.cs</a>	1732
12.8	<a href="#">ClinicalTrialIdentificationWorkflow.cs</a>	1733
12.9	<a href="#">GenerateDICOMDIR.cs</a>	1735
12.10	<a href="#">GenFakelImage.cxx</a>	1736
12.11	<a href="#">ReformatFile.cs</a>	1737
12.12	<a href="#">DecompressImage.cs</a>	1738
12.13	<a href="#">StandardizeFiles.cs</a>	1740
12.14	<a href="#">ScanDirectory.cs</a>	1741
12.15	<a href="#">BasicAnonymizer.cs</a>	1742
12.16	<a href="#">BasicImageAnonymizer.cs</a>	1743
12.17	<a href="#">CompressLossyJPEG.cs</a>	1744
12.18	<a href="#">DecompressImageMultiframe.cs</a>	1745
12.19	<a href="#">DumpCSA.cs</a>	1747
12.20	<a href="#">ExtractEncapsulatedFile.cs</a>	1748
12.21	<a href="#">ExtractImageRegion.cs</a>	1749
12.22	<a href="#">ExtractImageRegionWithLUT.cs</a>	1750
12.23	<a href="#">ExtractOneFrame.cs</a>	1751
12.24	<a href="#">FileAnonymize.cs</a>	1752
12.25	<a href="#">FileChangeTS.cs</a>	1753
12.26	<a href="#">FileChangeTSLossy.cs</a>	1755
12.27	<a href="#">FileStreaming.cs</a>	1757



---

12.28	GetArray.cs	1758
12.29	MpegVideoInfo.cs	1759
12.30	NewSequence.cs	1763
12.31	RescaleImage.cs	1764
12.32	SendFileSCU.cs	1765
12.33	SimplePrintPatientName.cs	1765
12.34	SortImage2.cs	1766
12.35	CStoreQtProgress.cxx	1766
12.36	ChangePrivateTags.cxx	1768
12.37	ChangeSequenceUltrasound.cxx	1769
12.38	CheckBigEndianBug.cxx	1770
12.39	ClinicalTrialAnnotate.cxx	1772
12.40	CompressImage.cxx	1773
12.41	ConvertToQImage.cxx	1774
12.42	CreateARGBImage.cxx	1775
12.43	CreateCMYKImage.cxx	1776
12.44	CreateJPIPDataSet.cxx	1777
12.45	DeriveSeries.cxx	1778
12.46	DiffFile.cxx	1779
12.47	DiscriminateVolume.cxx	1780
12.48	DumpADAC.cxx	1783
12.49	DumpExamCard.cxx	1787
12.50	DumpGEMSMovieGroup.cxx	1795
12.51	DumpImageHeaderInfo.cxx	1801
12.52	DumpPhilipsECHO.cxx	1803
12.53	DumpSiemensBase64.cxx	1808
12.54	DumpToSQLITE3.cxx	1809
12.55	DumpToshibaDTI.cxx	1810
12.56	DumpToshibaDTI2.cxx	1812
12.57	DumpVisusChange.cxx	1813
12.58	DuplicatePCDE.cxx	1815
12.59	ELSCINT1WaveToText.cxx	1817
12.60	EmptyMask.cxx	1819
12.61	EncapsulateFileInRawData.cxx	1819
12.62	ExtractEncryptedContent.cxx	1820
12.63	ExtractIconFromFile.cxx	1821
12.64	Extracting_All_Resolution.cxx	1822
12.65	Fake_Image_Using_Stream_Image_Writer.cxx	1827
12.66	FixBrokenJ2K.cxx	1829

---

12.67 FixJAIBugJPEGLS.cxx	1831
12.68 FixOrientation.cxx	1834
12.69 GenAllIVR.cxx	1835
12.70 GenFakeIdentifyFile.cxx	1836
12.71 GenLongSeqs.cxx	1839
12.72 GenSeqs.cxx	1840
12.73 GenerateStandardSOPClasses.cxx	1841
12.74 GetJPEGSamplePrecision.cxx	1842
12.75 GetSequenceUltrasound.cxx	1843
12.76 GetSubSequenceData.cxx	1845
12.77 HelloVizWorld.cxx	1847
12.78 HelloWorld.cxx	1848
12.79 LargeVRDSExplicit.cxx	1849
12.80 MakeTemplate.cxx	1851
12.81 MergeTwoFiles.cxx	1852
12.82 MrProtocol.cxx	1853
12.83 PrintLUT.cxx	1859
12.84 PublicDict.cxx	1860
12.85 QIDO-RS.cxx	1861
12.86 ReadAndDumpDICOMDIR.cxx	1861
12.87 ReadAndDumpDICOMDIR2.cxx	1863
12.88 ReadAndPrintAttributes.cxx	1867
12.89 ReadExplicitLengthSQIVR.cxx	1869
12.90 ReadGEMSSDO.cxx	1869
12.91 ReadMultiTimesException.cxx	1871
12.92 ReadUTF8QtDir.cxx	1872
12.93 SimpleScanner.cxx	1873
12.94 SortImage.cxx	1875
12.95 StreamImageReaderTest.cxx	1876
12.96 TemplateEmptyImage.cxx	1879
12.97 TraverseModules.cxx	1881
12.98 VolumeSorter.cxx	1882
12.99 csa2img.cxx	1884
12.100 iU22tomultisc.cxx	1886
12.101 pmsct_rgb1.cxx	1887
12.102 rle2img.cxx	1890
12.103 uid_unique.cxx	1893
12.104 DecompressImage.java	1893
12.105 DecompressPixmap.java	1894

---

12.106 ExtractImageRegion.java	1895
12.107 FileAnonymize.java	1896
12.108 HelloSimple.java	1897
12.109 ReadFiles.java	1897
12.110 ScanDirectory.java	1898
12.111 SimplePrint.java	1902
12.112 AddPrivateAttribute.py	1903
12.113 ConvertMPL.py	1903
12.114 ConvertNumpy.py	1904
12.115 ConvertPIL.py	1905
12.116 CreateRAWStorage.py	1906
12.117 DecompressImage.py	1908
12.118 DumbAnonymizer.py	1909
12.119 ExtractImageRegion.py	1910
12.120 FindAllPatientName.py	1911
12.121 FixCommaBug.py	1912
12.122 GetPortionCSAHeader.py	1913
12.123 HelloWorld.py	1914
12.124 ManipulateFile.py	1914
12.125 ManipulateSequence.py	1916
12.126 MergeFile.py	1916
12.127 NewSequence.py	1917
12.128 PhilipsPrivateRescaleInterceptSlope.py	1918
12.129 PlaySound.py	1919
12.130 PrivateDict.py	1920
12.131 ReWriteSCAsMR.py	1920
12.132 ReadAndDumpDICOMDIR.py	1921
12.133 RemovePrivateTags.py	1923
12.134 ScanDirectory.py	1924
12.135 SortImage.py	1925
12.136 WriteBuffer.py	1925
12.137 HelloActiviz.cs	1926
12.138 HelloActiviz2.cs	1927
12.139 HelloActiviz3.cs	1928
12.140 HelloActiviz4.cs	1929
12.141 HelloActiviz5.cs	1930
12.142 HelloVTKWorld.cs	1931
12.143 HelloVTKWorld2.cs	1931
12.144 MetalImageMD5Activiz.cs	1932

12.145 RefCounting.cs	1933
12.146 Compute3DSpacing.cxx	1934
12.147 Convert16BitsTo8Bits.cxx	1935
12.148 ConvertMultiFrameToSingleFrame.cxx	1936
12.149 ConvertRGBToLuminance.cxx	1937
12.150 ConvertSingleBitTo8Bits.cxx	1938
12.151 CreateFakePET.cxx	1939
12.152 CreateFakeRTDOSE.cxx	1940
12.153 GenerateRTSTRUCT.cxx	1942
12.154 MagnifyFile.cxx	1944
12.155 gdcmortoplanes.cxx	1945
12.156 gdcmmreslice.cxx	1950
12.157 gdcmrionplan.cxx	1952
12.158 gdcmrtpplan.cxx	1956
12.159 gdcmscene.cxx	1959
12.160 gdcmttexture.cxx	1961
12.161 gdcmvolume.cxx	1962
12.162 offscreenimage.cxx	1964
12.163 reslicesphere.cxx	1965
12.164 rtstructapp.cxx	1971
12.165 threadgdcmm.cxx	1973
12.166 AWTMedical3.java	1976
12.167 HelloVTKWorld.java	1979
12.168 MIPViewer.java	1980
12.169 MPRViewer.java	1982
12.170 MPRViewer2.java	1984
12.171 ReadSeriesIntoVTK.java	1988
12.172 CastConvertPhilips.py	1989
12.173 headsq2dcm.py	1991

**Index**

**1993**

# Chapter 1

## GDCM Documentation

This is the developers documentation.

A PDF version of this doxygen documentation can be found here:

`http://gdcm.sourceforge.net/3.0/gdcm-3.0.10.pdf`

A tarball version of this HTML doxygen documentation can be found here:

`http://gdcm.sourceforge.net/3.0/gdcm-3.0.10-doc.tar.gz`

**Author**

Mathieu Malaterre



## Chapter 2

# Todo List

### Class [gdcm::CSAHeader](#)

MrEvaProtocol in 29,1020 contains ^M that would be nice to get rid of on UNIX system...

### Class [gdcm::network::ApplicationContext](#)

Looks like Application Context can only be 64 bytes at max (see Figure 9-1 / PS 3.8 - 2009 )

### Class [gdcm::Overlay](#)

Is there actually any way to recognize an overlay ? On images with multiple overlay I do not see any way to differentiate them (other than the group tag).

### Class [gdcm::SequenceOfFragments](#)

I do not enforce that Sequence of Fragments ends with a SQ end del

### Class [gdcm::TransferSyntax](#)

: The implementation is completely retarded -> see [gdcm::UIDs](#) for a replacement We need: IsSupported We need preprocess of raw/xml file We need GetFullName()

### Member [gdcm::UIDGenerator::IsValid](#) (**const char \*uid**)

: Move that in DataStructureAndEncoding (see FileMetaInformation::CheckFileMetaInformation)





## Chapter 3

# Deprecated List

Member [gdcm::CompositeNetworkFunctions::ConstructQuery](#) (ERootType inRootType, EQueryLevel in↔ QueryLevel, const KeyValuePairArrayType &keys, EQueryType queryType=eFind)

Member [gdcm::FileSet::AddFile](#) (File const &)

. Does nothing

Member [gdcm::TransferSyntax::GetSwapCode](#) () const

Return the [SwapCode](#) associated with the Transfer Syntax. Be careful with the special GE private syntax the [DataSet](#) is written in little endian but the Pixel Data is in Big Endian.



## Chapter 4

# Bug List

### Class `gdcm::DICOMDIRGenerator`

: There is a current limitation of not handling Referenced SOP Class UID / Referenced SOP Instance UID simply because the `Scanner` does not allow us See PS 3.11 / [Table D.3-2 STD-GEN Additional DICOMDIR Keys](#)

### Member `gdcm::FileStreamer::StartGroupDataElement (const PrivateTag &pt, size_t maxsize=0, uint8_t startoffset=0)`

`maxsize` should be a value lower than the actual total size of the buffer to be copied

### Class `gdcm::IPPSorter`

There are currently a couple of bugs in this implementation:



# Chapter 5

## Namespace Index

### 5.1 Namespace List

Here is a list of all namespaces with brief descriptions:

<a href="#">gdc</a>	43
<a href="#">gdc::network</a>	77
<a href="#">gdc::SegmentHelper</a>	84
<a href="#">gdc::terminal</a>	84
Class for Terminal	84



# Chapter 6

## Hierarchical Index

### 6.1 Class Hierarchy

This inheritance list is sorted roughly, but not completely, alphabetically:

gdcmm::network::AbstractSyntax	104
gdcmm::network::ApplicationContext	119
gdcmm::ApplicationEntity	121
gdcmm::network::ARTIMTimer	129
gdcmm::ASN1	130
gdcmm::network::AsynchronousOperationsWindowSub	132
gdcmm::Attribute< Group, Element, TVR, TVM >	134
gdcmm::Attribute< Group, Element, TVR, VM::VM1 >	144
gdcmm::Attribute< Group, Element, TVR, VM::VM1_n >	153
gdcmm::Attribute< Group, Element, TVR, VM::VM1_3 >	151
gdcmm::Attribute< Group, Element, TVR, VM::VM1_8 >	152
gdcmm::Attribute< Group, Element, TVR, VM::VM2_n >	161
gdcmm::Attribute< Group, Element, TVR, VM::VM2_2n >	160
gdcmm::Attribute< Group, Element, TVR, VM::VM3_n >	164
gdcmm::Attribute< Group, Element, TVR, VM::VM3_3n >	163
gdcmm::Base64	168
gdcmm::network::BaseCompositeMessage	171
gdcmm::network::CEchoRQ	237
gdcmm::network::CEchoRSP	239
gdcmm::network::CFindCancelRQ	240
gdcmm::network::CFindRQ	242
gdcmm::network::CFindRSP	243
gdcmm::network::CMoveCancelRq	245
gdcmm::network::CMoveRQ	246
gdcmm::network::CMoveRSP	247
gdcmm::network::CStoreRQ	300
gdcmm::network::CStoreRSP	301
gdcmm::network::BaseNormalizedMessage	173
gdcmm::network::NActionRQ	723
gdcmm::network::NActionRSP	724

gdcmm::network::NCreateRQ . . . . .	726
gdcmm::network::NCreateRSP . . . . .	727
gdcmm::network::NDeleteRQ . . . . .	729
gdcmm::network::NDeleteRSP . . . . .	730
gdcmm::network::NEventReportRQ . . . . .	735
gdcmm::network::NEventReportRSP . . . . .	736
gdcmm::network::NGetRQ . . . . .	738
gdcmm::network::NGetRSP . . . . .	739
gdcmm::network::NSetRQ . . . . .	746
gdcmm::network::NSetRSP . . . . .	748
gdcmm::network::BasePDU . . . . .	175
gdcmm::network::AAabortPDU . . . . .	87
gdcmm::network::AAAssociateACPDU . . . . .	90
gdcmm::network::AAAssociateRJPDU . . . . .	94
gdcmm::network::AAAssociateRQPDU . . . . .	97
gdcmm::network::AReleaseRPPDU . . . . .	124
gdcmm::network::AReleaseRQPDU . . . . .	126
gdcmm::network::PDataTFPDU . . . . .	785
std::basic_string< Char >	
std::string	
gdcmm::String< TDelimiter, TMaxLength, TPadChar > . . . . .	1045
gdcmm::SegmentHelper::BasicCodedEntry . . . . .	188
gdcmm::BitmapToBitmapFilter . . . . .	209
gdcmm::PixmapToPixmapFilter . . . . .	829
gdcmm::ImageToImageFilter . . . . .	582
gdcmm::ImageApplyLookupTable . . . . .	532
gdcmm::ImageChangePhotometricInterpretation . . . . .	535
gdcmm::ImageChangePlanarConfiguration . . . . .	539
gdcmm::ImageChangeTransferSyntax . . . . .	543
gdcmm::ImageFragmentSplitter . . . . .	564
gdcmm::ByteBuffer . . . . .	217
gdcmm::ByteSwap< T > . . . . .	219
gdcmm::ByteSwapFilter . . . . .	221
gdcmm::network::CFind . . . . .	240
gdcmm::Coder . . . . .	250
gdcmm::Codec . . . . .	249
gdcmm::AudioCodec . . . . .	166
gdcmm::ImageCodec . . . . .	548
gdcmm::DeltaEncodingCodec . . . . .	352
gdcmm::JPEG2000Codec . . . . .	622
gdcmm::JPEGCodec . . . . .	633
gdcmm::JPEG12Codec . . . . .	616
gdcmm::JPEG16Codec . . . . .	619
gdcmm::JPEG8Codec . . . . .	629
gdcmm::JPEGLSCodec . . . . .	641
gdcmm::KAKADUCodec . . . . .	650
gdcmm::PGXCodec . . . . .	803
gdcmm::PNMCodec . . . . .	837
gdcmm::PVRGCodec . . . . .	878
gdcmm::RAWCodec . . . . .	898
gdcmm::RLECodec . . . . .	919
gdcmm::PDFCodec . . . . .	794
gdcmm::CodeString . . . . .	252



gdcmm::network::CompositeMessageFactory . . . . .	263
gdcmm::CompositeNetworkFunctions . . . . .	264
gdcmm::ConstCharWrapper . . . . .	269
gdcmm::CryptoFactory . . . . .	272
gdcmm::CAPICryptoFactory . . . . .	232
gdcmm::OpenSSLCryptoFactory . . . . .	753
gdcmm::OpenSSLP7CryptoFactory . . . . .	758
gdcmm::CryptographicMessageSyntax . . . . .	275
gdcmm::CAPICryptographicMessageSyntax . . . . .	233
gdcmm::OpenSSLCryptographicMessageSyntax . . . . .	755
gdcmm::OpenSSLP7CryptographicMessageSyntax . . . . .	760
gdcmm::CSAElement . . . . .	278
gdcmm::CSAHeader . . . . .	286
gdcmm::CSAHeaderDict . . . . .	292
gdcmm::CSAHeaderDictEntry . . . . .	295
gdcmm::DataElement . . . . .	309
gdcmm::CP246ExplicitDataElement . . . . .	270
gdcmm::ExplicitDataElement . . . . .	441
gdcmm::ExplicitImplicitDataElement . . . . .	444
gdcmm::Fragment . . . . .	507
gdcmm::BasicOffsetTable . . . . .	191
gdcmm::ImplicitDataElement . . . . .	593
gdcmm::Item . . . . .	610
gdcmm::UNExplicitDataElement . . . . .	1254
gdcmm::UNExplicitImplicitDataElement . . . . .	1257
gdcmm::VR16ExplicitDataElement . . . . .	1294
gdcmm::DataSet . . . . .	327
gdcmm::CommandDataSet . . . . .	260
gdcmm::FileMetaInformation . . . . .	470
gdcmm::DataSetHelper . . . . .	344
gdcmm::Decoder . . . . .	345
gdcmm::Codec . . . . .	249
gdcmm::DefinedTerms . . . . .	347
gdcmm::Defs . . . . .	347
gdcmm::DICOMDIR . . . . .	354
gdcmm::DICOMDIRGenerator . . . . .	355
gdcmm::Dict . . . . .	359
gdcmm::DictConverter . . . . .	363
gdcmm::DictEntry . . . . .	368
gdcmm::Dicts . . . . .	376
gdcmm::network::DIMSE . . . . .	380
gdcmm::DirectionCosines . . . . .	382
gdcmm::Directory . . . . .	385
gdcmm::DirectoryHelper . . . . .	390
gdcmm::DummyValueGenerator . . . . .	392
gdcmm::Element< TVR, TVM > . . . . .	395
gdcmm::Element< TVR, VM::VM1_n > . . . . .	403
gdcmm::Element< TVR, VM::VM1_2 > . . . . .	401
gdcmm::Element< TVR, VM::VM2_n > . . . . .	410
gdcmm::Element< TVR, VM::VM2_2n > . . . . .	408
gdcmm::Element< TVR, VM::VM3_4 > . . . . .	414
gdcmm::Element< TVR, VM::VM3_n > . . . . .	416

gdcmm::Element< TVR, VM::VM3_3n > . . . . .	412
gdcmm::Element< VR::AS, VM::VM5 > . . . . .	417
gdcmm::Element< VR::OB, VM::VM1_n > . . . . .	395
gdcmm::Element< VR::OB, VM::VM1 > . . . . .	418
gdcmm::Element< VR::OW, VM::VM1_n > . . . . .	395
gdcmm::Element< VR::OW, VM::VM1 > . . . . .	420
gdcmm::ElementDisableCombinations< TVR, TVM > . . . . .	422
gdcmm::ElementDisableCombinations< VR::OB, VM::VM1_n > . . . . .	423
gdcmm::ElementDisableCombinations< VR::OW, VM::VM1_n > . . . . .	423
gdcmm::EmptyMaskGenerator . . . . .	423
gdcmm::EncapsulatedDocument . . . . .	426
gdcmm::EncodingImplementation< T > . . . . .	427
gdcmm::EncodingImplementation< VR::VRASCII > . . . . .	428
gdcmm::EncodingImplementation< VR::VRBINARY > . . . . .	429
gdcmm::EnumeratedValues . . . . .	432
gdcmm::EquipmentManufacturer . . . . .	432
gdcmm::Event . . . . .	434
gdcmm::AnyEvent . . . . .	118
gdcmm::AbortEvent . . . . .	103
gdcmm::AnonymizeEvent . . . . .	107
gdcmm::DataEvent . . . . .	323
gdcmm::DataSetEvent . . . . .	340
gdcmm::EndEvent . . . . .	431
gdcmm::ExitEvent . . . . .	440
gdcmm::FileNameEvent . . . . .	483
gdcmm::InitializeEvent . . . . .	596
gdcmm::IterationEvent . . . . .	615
gdcmm::ModifiedEvent . . . . .	704
gdcmm::ProgressEvent . . . . .	874
gdcmm::StartEvent . . . . .	1023
gdcmm::UserEvent . . . . .	1263
gdcmm::NoEvent . . . . .	741
std::exception	
gdcmm::CSAHeaderDictException . . . . .	299
gdcmm::DataElementException . . . . .	323
gdcmm::Exception . . . . .	438
gdcmm::ParseException . . . . .	777
gdcmm::Fiducials . . . . .	447
gdcmm::FileDerivation . . . . .	463
gdcmm::FileExplicitFilter . . . . .	467
gdcmm::Filename . . . . .	479
gdcmm::FilenameGenerator . . . . .	487
gdcmm::FileSet . . . . .	491
gdcmm::Global . . . . .	510
gdcmm::GroupDict . . . . .	514
gdcmm::IconImageFilter . . . . .	517
gdcmm::IconImageGenerator . . . . .	520
gdcmm::ignore_char . . . . .	524
gdcmm::ImageConverter . . . . .	562
gdcmm::ImageHelper . . . . .	567
gdcmm::network::ImplementationClassUIDSub . . . . .	589
gdcmm::network::ImplementationUIDSub . . . . .	590
gdcmm::network::ImplementationVersionNameSub . . . . .	591

gdcM::IOD	597
gdcM::IODEntry	599
gdcM::IODs	602
gdcM::JSON	648
gdcM::Scanner::ltstr	666
gdcM::StrictScanner::ltstr	667
gdcM::Macro	667
gdcM::Macros	670
gdcM::network::MaximumLengthSub	672
gdcM::MD5	674
gdcM::MediaStorage	675
gdcM::Module	705
gdcM::ModuleEntry	708
gdcM::NestedModuleEntries	732
gdcM::Modules	712
gdcM::MrProtocol	720
gdcM::network::NormalizedMessageFactory	742
gdcM::NormalizedNetworkFunctions	743
gdcM::Object	749
gdcM::BaseQuery	177
gdcM::BaseRootQuery	183
gdcM::FindPatientRootQuery	501
gdcM::FindStudyRootQuery	504
gdcM::MovePatientRootQuery	715
gdcM::MoveStudyRootQuery	718
gdcM::WLMFindQuery	1415
gdcM::ModalityPerformedProcedureStepCreateQuery	698
gdcM::ModalityPerformedProcedureStepSetQuery	701
gdcM::Bitmap	194
gdcM::Pixmap	819
gdcM::Image	525
gdcM::Curve	303
gdcM::File	447
gdcM::FileWithName	498
gdcM::LookupTable	658
gdcM::SegmentedPaletteColorLookupTable	946
gdcM::MeshPrimitive	692
gdcM::Overlay	766
gdcM::Segment	936
gdcM::Subject	1055
gdcM::Anonymizer	110
gdcM::Command	257
gdcM::MemberCommand< T >	686
gdcM::SimpleMemberCommand< T >	992
gdcM::FileAnonymizer	452
gdcM::FileChangeTransferSyntax	456
gdcM::FileDecompressLookupTable	460
gdcM::FileStreamer	493
gdcM::Scanner	927
gdcM::ServiceClassUser	982
gdcM::StrictScanner	1036
gdcM::network::ULConnectionManager	1240
gdcM::Surface	1059

gdcmm::Value . . . . .	1270
gdcmm::ByteValue . . . . .	223
gdcmm::SequenceOfFragments . . . . .	957
gdcmm::SequenceOfItems . . . . .	964
gdcmm::Orientation . . . . .	763
gdcmm::Parser . . . . .	779
gdcmm::Patient . . . . .	784
gdcmm::PDBelement . . . . .	788
gdcmm::PDBHeader . . . . .	791
gdcmm::network::PDUFactory . . . . .	797
gdcmm::PersonName . . . . .	800
gdcmm::PhotometricInterpretation . . . . .	806
gdcmm::PixelFormat . . . . .	810
gdcmm::Preamble . . . . .	840
gdcmm::PresentationContext . . . . .	845
gdcmm::network::PresentationContextAC . . . . .	849
gdcmm::PresentationContextGenerator . . . . .	851
gdcmm::network::PresentationContextRQ . . . . .	855
gdcmm::network::PresentationDataValue . . . . .	859
gdcmm::Printer . . . . .	863
gdcmm::DictPrinter . . . . .	373
gdcmm::Dumper . . . . .	393
gdcmm::PrivateDict . . . . .	868
gdcmm::PythonFilter . . . . .	881
gdcmm::QueryBase . . . . .	883
gdcmm::QueryImage . . . . .	888
gdcmm::QueryPatient . . . . .	890
gdcmm::QuerySeries . . . . .	893
gdcmm::QueryStudy . . . . .	895
gdcmm::QueryFactory . . . . .	886
gdcmm::Reader . . . . .	902
gdcmm::PixmapReader . . . . .	825
gdcmm::ImageReader . . . . .	574
gdcmm::ImageRegionReader . . . . .	578
gdcmm::SegmentReader . . . . .	949
gdcmm::SurfaceReader . . . . .	1077
gdcmm::RealWorldValueMappingContent . . . . .	910
gdcmm::Region . . . . .	911
gdcmm::BoxRegion . . . . .	212
gdcmm::Rescaler . . . . .	914
gdcmm::network::RoleSelectionSub . . . . .	925
gdcmm::SerieHelper . . . . .	973
gdcmm::Series . . . . .	979
gdcmm::network::ServiceClassApplicationInformation . . . . .	980
gdcmm::SHA1 . . . . .	990
gdcmm::SimpleSubjectWatcher . . . . .	997
gdcmm::MrProtocol::Slice . . . . .	1001
gdcmm::MrProtocol::SliceArray . . . . .	1002
gdcmm::SmartPointer< ObjectType > . . . . .	1003
gdcmm::SmartPointer< gdcmm::Bitmap > . . . . .	1003
gdcmm::SmartPointer< gdcmm::File > . . . . .	1003
gdcmm::SmartPointer< gdcmm::Image > . . . . .	1003
gdcmm::SmartPointer< gdcmm::MemberCommand > . . . . .	1003

gdcmm::SmartPointer< gdcmm::MeshPrimitive >	1003
gdcmm::SmartPointer< gdcmm::Pixmap >	1003
gdcmm::SmartPointer< gdcmm::SimpleMemberCommand >	1003
gdcmm::SmartPointer< gdcmm::Subject >	1003
gdcmm::SmartPointer< LookupTable >	1003
gdcmm::SmartPointer< Segment >	1003
gdcmm::SmartPointer< Surface >	1003
gdcmm::SmartPointer< Value >	1003
gdcmm::network::SOPClassExtendedNegociationSub	1007
gdcmm::SOPClassUIDToIOD	1009
gdcmm::Sorter	1011
gdcmm::IPPSorter	605
gdcmm::Spacing	1016
gdcmm::Spectroscopy	1018
gdcmm::SplitMosaicFilter	1019
gdcmm::static_assert_test< x >	1024
gdcmm::STATIC_ASSERTION_FAILURE< x >	1024
gdcmm::STATIC_ASSERTION_FAILURE< true >	1024
gdcmm::StreamImageReader	1025
gdcmm::StreamImageWriter	1029
String<'\', 64 >	
gdcmm::LO	654
gdcmm::StringFilter	1050
gdcmm::Study	1055
gdcmm::SurfaceHelper	1074
gdcmm::SwapCode	1084
gdcmm::SwapperDoOp	1086
gdcmm::SwapperNoOp	1087
gdcmm::System	1088
gdcmm::Table	1096
gdcmm::TableEntry	1099
gdcmm::TableReader	1100
gdcmm::XMLDictReader	1424
gdcmm::XMLPrivateDictReader	1431
gdcmm::network::TableRow	1104
gdcmm::Tag	1105
gdcmm::PrivateTag	871
gdcmm::TagPath	1116
gdcmm::Testing	1119
gdcmm::Trace	1127
gdcmm::TransferSyntax	1132
gdcmm::network::TransferSyntaxSub	1139
gdcmm::network::Transition	1141
gdcmm::Type	1143
gdcmm::UI	1146
gdcmm::UIDGenerator	1146
gdcmm::UIDs	1149
gdcmm::network::ULAction	1187
gdcmm::network::ULActionAA1	1190
gdcmm::network::ULActionAA2	1191
gdcmm::network::ULActionAA3	1192
gdcmm::network::ULActionAA4	1194
gdcmm::network::ULActionAA5	1195

gdcM::network::ULActionAA6	.1196
gdcM::network::ULActionAA7	.1198
gdcM::network::ULActionAA8	.1199
gdcM::network::ULActionAE1	.1200
gdcM::network::ULActionAE2	.1202
gdcM::network::ULActionAE3	.1203
gdcM::network::ULActionAE4	.1204
gdcM::network::ULActionAE5	.1206
gdcM::network::ULActionAE6	.1207
gdcM::network::ULActionAE7	.1208
gdcM::network::ULActionAE8	.1210
gdcM::network::ULActionAR1	.1211
gdcM::network::ULActionAR10	.1212
gdcM::network::ULActionAR2	.1214
gdcM::network::ULActionAR3	.1215
gdcM::network::ULActionAR4	.1216
gdcM::network::ULActionAR5	.1218
gdcM::network::ULActionAR6	.1219
gdcM::network::ULActionAR7	.1220
gdcM::network::ULActionAR8	.1222
gdcM::network::ULActionAR9	.1223
gdcM::network::ULActionDT1	.1224
gdcM::network::ULActionDT2	.1226
gdcM::network::ULConnection	.1229
gdcM::network::ULConnectionCallback	.1235
gdcM::network::ULBasicCallback	.1227
gdcM::network::ULWritingCallback	.1252
gdcM::network::ULConnectionInfo	.1238
gdcM::network::ULEvent	.1248
gdcM::network::ULTransitionTable	.1250
gdcM::Unpacker12Bits	.1259
gdcM::Usage	.1260
gdcM::network::UserInformation	.1264
gdcM::UUIDGenerator	.1266
gdcM::Validate	.1267
gdcM::ValueIO< TDE, TSwap, TType >	.1273
gdcM::MrProtocol::Vector3	.1274
gdcM::Version	.1274
gdcM::VL	.1277
gdcM::VM	.1281
gdcM::VMToLength< T >	.1286
gdcM::VR	.1286
gdcM::VRToEncoding< T >	.1296
gdcM::VRToType< T >	.1296
gdcM::VRToType< TagToType< Group, Element >::VRType >	.1296
gdcM::VRToType< TVR >	.1296
gdcM::VRVLSIZE< T >	.1297
gdcM::VRVLSIZE< 0 >	.1297
gdcM::VRVLSIZE< 1 >	.1297
vtkImageAlgorithm	
vtkImagePlanarComponentsToComponents	.1392
vtkImageMapToColors	
vtkImageMapToWindowLevelColors2	.1388
vtkImageWriter	

vtkGDCMImageWriter . . . . .	.1328
vtkLookupTable	
vtkLookupTable16 . . . . .	.1399
vtkMedicalImageProperties	
vtkGDCMMedicalImageProperties . . . . .	.1337
vtkMedicalImageReader2	
vtkGDCMImageReader . . . . .	.1298
vtkGDCMThreadedImageReader . . . . .	.1354
vtkGDCMImageReader2 . . . . .	.1313
vtkObject	
vtkGDCMTesting . . . . .	.1350
vtkImageColorViewer . . . . .	.1367
vtkRTStructSetProperties . . . . .	.1403
vtkPolyDataAlgorithm	
vtkGDCMPolyDataReader . . . . .	.1340
vtkPolyDataWriter	
vtkGDCMPolyDataWriter . . . . .	.1345
vtkThreadedImageAlgorithm	
vtkGDCMThreadedImageReader2 . . . . .	.1358
vtkImageMapToColors16 . . . . .	.1382
vtkImageRGBToYBR . . . . .	.1394
vtkImageYBRToRGB . . . . .	.1397
gdcM::Waveform . . . . .	.1414
gdcM::Writer . . . . .	.1418
gdcM::PixmapWriter . . . . .	.832
gdcM::ImageWriter . . . . .	.585
gdcM::SegmentWriter . . . . .	.953
gdcM::SurfaceWriter . . . . .	.1081
gdcM::XMLPrinter . . . . .	.1427





# Chapter 7

## Class Index

### 7.1 Class List

Here are the classes, structs, unions and interfaces with brief descriptions:

gdcn::network::AAabortPDU	
AAabortPDU	87
gdcn::network::AAssociateACPDU	
AAssociateACPDU	90
gdcn::network::AAssociateRJPDU	
AAssociateRJPDU	94
gdcn::network::AAssociateRQPDU	
AAssociateRQPDU	97
gdcn::AbortEvent	103
gdcn::network::AbstractSyntax	
AbstractSyntax	104
gdcn::AnonymizeEvent	
AnonymizeEvent	107
gdcn::Anonymizer	
Anonymizer	110
gdcn::AnyEvent	118
gdcn::network::ApplicationContext	
ApplicationContext	119
gdcn::ApplicationEntity	
ApplicationEntity	121
gdcn::network::AReleaseRPPDU	
AReleaseRPPDU	124
gdcn::network::AReleaseRQPDU	
AReleaseRQPDU	126
gdcn::network::ARTIMTimer	
ARTIMTimer	129
gdcn::ASN1	
Class for ASN1	130
gdcn::network::AsynchronousOperationsWindowSub	
AsynchronousOperationsWindowSub	132

gdcmm::Attribute< Group, Element, TVR, TVM >	
Attribute class This class use template metaprograming tricks to let the user know when the template instantiation does not match the public dictionary	134
gdcmm::Attribute< Group, Element, TVR, VM::VM1 >	144
gdcmm::Attribute< Group, Element, TVR, VM::VM1_3 >	151
gdcmm::Attribute< Group, Element, TVR, VM::VM1_8 >	152
gdcmm::Attribute< Group, Element, TVR, VM::VM1_n >	153
gdcmm::Attribute< Group, Element, TVR, VM::VM2_2n >	160
gdcmm::Attribute< Group, Element, TVR, VM::VM2_n >	161
gdcmm::Attribute< Group, Element, TVR, VM::VM3_3n >	163
gdcmm::Attribute< Group, Element, TVR, VM::VM3_n >	164
gdcmm::AudioCodec	
AudioCodec	166
gdcmm::Base64	
Class for Base64	168
gdcmm::network::BaseCompositeMessage	
BaseCompositeMessage	171
gdcmm::network::BaseNormalizedMessage	
BaseNormalizedMessage	173
gdcmm::network::BasePDU	
BasePDU	175
gdcmm::BaseQuery	
BaseQuery	177
gdcmm::BaseRootQuery	
BaseRootQuery	183
gdcmm::SegmentHelper::BasicCodedEntry	
This structure defines a basic coded entry with all of its attributes	188
gdcmm::BasicOffsetTable	
Class to represent a BasicOffsetTable	191
gdcmm::Bitmap	
Bitmap class	194
gdcmm::BitmapToBitmapFilter	
BitmapToBitmapFilter class	209
gdcmm::BoxRegion	
Class for manipulation box region	212
gdcmm::ByteBuffer	
ByteBuffer	217
gdcmm::ByteSwap< T >	
ByteSwap	219
gdcmm::ByteSwapFilter	
ByteSwapFilter	221
gdcmm::ByteValue	
Class to represent binary value (array of bytes)	223
gdcmm::CAPICryptoFactory	232
gdcmm::CAPICryptographicMessageSyntax	233
gdcmm::network::CEchoRQ	
CEchoRQ	237
gdcmm::network::CEchoRSP	
CEchoRSP this file defines the messages for the cecho action	239
gdcmm::network::CFind	240
gdcmm::network::CFindCancelRQ	
CFindCancelRQ this file defines the messages for the cfind action	240
gdcmm::network::CFindRQ	
CFindRQ	242

gdcn::network::CFindRSP	
CFindRSP this file defines the messages for the cfind action	243
gdcn::network::CMoveCancelRq	245
gdcn::network::CMoveRQ	
CMoveRQ	246
gdcn::network::CMoveRSP	
CMoveRSP this file defines the messages for the cmove action	247
gdcn::Codec	
Codec class	249
gdcn::Coder	
Coder	250
gdcn::CodeString	
CodeString	252
gdcn::Command	
Command superclass for callback/observer methods	257
gdcn::CommandDataSet	
Class to represent a <a href="#">Command DataSet</a>	260
gdcn::network::CompositeMessageFactory	
CompositeMessageFactory	263
gdcn::CompositeNetworkFunctions	
Composite Network Functions	264
gdcn::ConstCharWrapper	
Do not use me	269
gdcn::CP246ExplicitDataElement	
Class to read/write a <a href="#">DataElement</a> as CP246Explicit Data <a href="#">Element</a>	270
gdcn::CryptoFactory	
Class to do handle the crypto factory	272
gdcn::CryptographicMessageSyntax	275
gdcn::CSAElement	
Class to represent a CSA <a href="#">Element</a>	278
gdcn::CSAHeader	
Class for <a href="#">CSAHeader</a>	286
gdcn::CSAHeaderDict	
Class to represent a map of <a href="#">CSAHeaderDictEntry</a>	292
gdcn::CSAHeaderDictEntry	
Class to represent an Entry in the <a href="#">Dict</a>	295
gdcn::CSAHeaderDictException	299
gdcn::network::CStoreRQ	
CStoreRQ	300
gdcn::network::CStoreRSP	
CStoreRSP this file defines the messages for the cecho action	301
gdcn::Curve	
Curve class to handle element 50xx,3000 <a href="#">Curve</a> Data	303
gdcn::DataElement	
Class to represent a Data <a href="#">Element</a> either Implicit or Explicit	309
gdcn::DataElementException	323
gdcn::DataEvent	
DataEvent	323
gdcn::DataSet	
Class to represent a Data Set (which contains Data Elements)	327
gdcn::DataSetEvent	
DataSetEvent	340
gdcn::DataSetHelper	
DataSetHelper (internal class, not intended for user level)	344

gdcM::Decoder	
Decoder	345
gdcM::DefinedTerms	
Defined Terms are used when the specified explicit Values may be extended by implementors to include additional new Values. These new Values shall be specified in the Conformance Statement (see PS 3.2) and shall not have the same meaning as currently defined Values in this standard. A Data Element with Defined Terms that does not contain a Value equivalent to one of the Values currently specified in this standard shall not be considered to have an invalid value. Note: Interpretation Type ID (4008,0210) is an example of a Data Element having Defined Terms. It is defined to have a Value that may be one of the set of standard Values; REPORT or AMENDMENT (see PS 3.3). Because this Data Element has Defined Terms other Interpretation Type IDs may be defined by the implementor	347
gdcM::Defs	
FIXME I do not like the name 'Defs'	347
gdcM::DeltaEncodingCodec	
DeltaEncodingCodec compression used by some private vendor	352
gdcM::DICOMDIR	
DICOMDIR class	354
gdcM::DICOMDIRGenerator	
DICOMDIRGenerator class	355
gdcM::Dict	
Class to represent a map of DictEntry	359
gdcM::DictConverter	
Class to convert a .dic file into something else:	363
gdcM::DictEntry	
Class to represent an Entry in the Dict	368
gdcM::DictPrinter	
DictPrinter class	373
gdcM::Dicts	
Class to manipulate the sum of knowledge (all the dict user load)	376
gdcM::network::DIMSE	
DIMSE	380
gdcM::DirectionCosines	
Class to handle DirectionCosines	382
gdcM::Directory	
Class for manipulation directories	385
gdcM::DirectoryHelper	
DirectoryHelper	390
gdcM::DummyValueGenerator	
Class for generating dummy value	392
gdcM::Dumper	
Codec class	393
gdcM::Element< TVR, TVM >	
Element class	395
gdcM::Element< TVR, VM::VM1_2 >	401
gdcM::Element< TVR, VM::VM1_n >	403
gdcM::Element< TVR, VM::VM2_2n >	408
gdcM::Element< TVR, VM::VM2_n >	410
gdcM::Element< TVR, VM::VM3_3n >	412
gdcM::Element< TVR, VM::VM3_4 >	414
gdcM::Element< TVR, VM::VM3_n >	416
gdcM::Element< VR::AS, VM::VM5 >	417
gdcM::Element< VR::OB, VM::VM1 >	418
gdcM::Element< VR::OW, VM::VM1 >	420

gdcmm::ElementDisableCombinations< TVR, TVM >	
A class which is used to produce compile errors for an invalid combination of template parameters	422
gdcmm::ElementDisableCombinations< VR::OB, VM::VM1_n >	423
gdcmm::ElementDisableCombinations< VR::OW, VM::VM1_n >	423
gdcmm::EmptyMaskGenerator	
EmptyMaskGenerator Main class to generate a Empty Mask Series from an input Series. This class takes an input folder and generates a series of DICOM files in the specified output directory. This class handles multiples DICOM Series within the same input directory	423
gdcmm::EncapsulatedDocument	
EncapsulatedDocument	426
gdcmm::EncodingImplementation< T >	
EncodingImplementation	427
gdcmm::EncodingImplementation< VR::VRASCII >	428
gdcmm::EncodingImplementation< VR::VRBINARY >	429
gdcmm::EndEvent	431
gdcmm::EnumeratedValues	
Element. A Data Element with Enumerated Values that does not have a Value equivalent to one of the Values specified in this standard has an invalid value within the scope of a specific Information Object/SOP Class definition. Note:	432
gdcmm::EquipmentManufacturer	432
gdcmm::Event	
Superclass for callback/observer methods	434
gdcmm::Exception	
Exception	438
gdcmm::ExitEvent	440
gdcmm::ExplicitDataElement	
Class to read/write a DataElement as Explicit Data Element	441
gdcmm::ExplicitImplicitDataElement	
Class to read/write a DataElement as ExplicitImplicit Data Element	444
gdcmm::Fiducials	
Fiducials	447
gdcmm::File	
DICOM File	447
gdcmm::FileAnonymizer	
FileAnonymizer	452
gdcmm::FileChangeTransferSyntax	
FileChangeTransferSyntax	456
gdcmm::FileDecompressLookupTable	
FileDecompressLookupTable class	460
gdcmm::FileDerivation	
FileDerivation class	463
gdcmm::FileExplicitFilter	
FileExplicitFilter class	467
gdcmm::FileMetaInformation	
Class to represent a File Meta Information	470
gdcmm::Filename	
Class to manipulate file name's	479
gdcmm::FilenameEvent	
FilenameEvent	483
gdcmm::FilenameGenerator	
FilenameGenerator	487
gdcmm::FileSet	491
gdcmm::FileStreamer	
FileStreamer	493

gdcM::FileWithName	
FileWithName	498
gdcM::FindPatientRootQuery	
PatientRootQuery	501
gdcM::FindStudyRootQuery	
FindStudyRootQuery	504
gdcM::Fragment	
Class to represent a <a href="#">Fragment</a>	507
gdcM::Global	
Global	510
gdcM::GroupDict	
Class to represent the mapping from group number to its abbreviation and name	514
gdcM::IconImageFilter	
IconImageFilter	517
gdcM::IconImageGenerator	
IconImageGenerator	520
gdcM::ignore_char	524
gdcM::Image	
Image	525
gdcM::ImageApplyLookupTable	
ImageApplyLookupTable class	532
gdcM::ImageChangePhotometricInterpretation	
ImageChangePhotometricInterpretation class	535
gdcM::ImageChangePlanarConfiguration	
ImageChangePlanarConfiguration class	539
gdcM::ImageChangeTransferSyntax	
ImageChangeTransferSyntax class	543
gdcM::ImageCodec	
ImageCodec	548
gdcM::ImageConverter	
Image Converter	562
gdcM::ImageFragmentSplitter	
ImageFragmentSplitter class	564
gdcM::ImageHelper	
ImageHelper (internal class, not intended for user level)	567
gdcM::ImageReader	
ImageReader	574
gdcM::ImageRegionReader	
ImageRegionReader	578
gdcM::ImageToImageFilter	
ImageToImageFilter class	582
gdcM::ImageWriter	
ImageWriter	585
gdcM::network::ImplementationClassUIDSub	
ImplementationClassUIDSub	589
gdcM::network::ImplementationUIDSub	
ImplementationUIDSub	590
gdcM::network::ImplementationVersionNameSub	
ImplementationVersionNameSub	591
gdcM::ImplicitDataElement	
Class to represent an <i>Implicit VR</i> <a href="#">Data Element</a>	593
gdcM::InitializeEvent	596
gdcM::IOD	
Class for representing a <a href="#">IOD</a>	597

<a href="#">gdcmm::IOEntry</a>	Class for representing a <a href="#">IOEntry</a> . . . . .	599
<a href="#">gdcmm::IODs</a>	Class for representing a <a href="#">IODs</a> . . . . .	602
<a href="#">gdcmm::IPPSorter</a>	<a href="#">IPPSorter</a> . . . . .	605
<a href="#">gdcmm::Item</a>	Class to represent an <a href="#">Item</a> . . . . .	610
<a href="#">gdcmm::IterationEvent</a>	. . . . .	615
<a href="#">gdcmm::JPEG12Codec</a>	Class to do JPEG 12bits (lossy & lossless) . . . . .	616
<a href="#">gdcmm::JPEG16Codec</a>	Class to do JPEG 16bits (lossless) . . . . .	619
<a href="#">gdcmm::JPEG2000Codec</a>	Class to do JPEG 2000 . . . . .	622
<a href="#">gdcmm::JPEG8Codec</a>	Class to do JPEG 8bits (lossy & lossless) . . . . .	629
<a href="#">gdcmm::JPEGCodec</a>	JPEG codec . . . . .	633
<a href="#">gdcmm::JPEGLSCodec</a>	JPEG-LS . . . . .	641
<a href="#">gdcmm::JSON</a>	. . . . .	648
<a href="#">gdcmm::KAKADUCodec</a>	<a href="#">KAKADUCodec</a> . . . . .	650
<a href="#">gdcmm::LO</a>	<a href="#">LO</a> . . . . .	654
<a href="#">gdcmm::LookupTable</a>	<a href="#">LookupTable</a> class . . . . .	658
<a href="#">gdcmm::Scanner::Itstr</a>	. . . . .	666
<a href="#">gdcmm::StrictScanner::Itstr</a>	. . . . .	667
<a href="#">gdcmm::Macro</a>	Class for representing a <a href="#">Macro</a> . . . . .	667
<a href="#">gdcmm::Macros</a>	Class for representing a <a href="#">Modules</a> . . . . .	670
<a href="#">gdcmm::network::MaximumLengthSub</a>	<a href="#">MaximumLengthSub</a> . . . . .	672
<a href="#">gdcmm::MD5</a>	Class for <a href="#">MD5</a> . . . . .	674
<a href="#">gdcmm::MediaStorage</a>	<a href="#">MediaStorage</a> . . . . .	675
<a href="#">gdcmm::MemberCommand&lt; T &gt;</a>	<a href="#">Command</a> subclass that calls a pointer to a member function . . . . .	686
<a href="#">gdcmm::MeshPrimitive</a>	This class defines surface mesh primitives . . . . .	692
<a href="#">gdcmm::ModalityPerformedProcedureStepCreateQuery</a>	<a href="#">ModalityPerformedProcedureStepCreateQuery</a> . . . . .	698
<a href="#">gdcmm::ModalityPerformedProcedureStepSetQuery</a>	<a href="#">ModalityPerformedProcedureStepSetQuery</a> . . . . .	701
<a href="#">gdcmm::ModifiedEvent</a>	. . . . .	704
<a href="#">gdcmm::Module</a>	Class for representing a <a href="#">Module</a> . . . . .	705
<a href="#">gdcmm::ModuleEntry</a>	Class for representing a <a href="#">ModuleEntry</a> . . . . .	708

<a href="#">gdcM::Modules</a>	
Class for representing a <a href="#">Modules</a>	712
<a href="#">gdcM::MovePatientRootQuery</a>	
<a href="#">MovePatientRootQuery</a>	715
<a href="#">gdcM::MoveStudyRootQuery</a>	
<a href="#">MoveStudyRootQuery</a>	718
<a href="#">gdcM::MrProtocol</a>	
Class for <a href="#">MrProtocol</a>	720
<a href="#">gdcM::network::NActionRQ</a>	
<a href="#">NActionRQ</a>	723
<a href="#">gdcM::network::NActionRSP</a>	
<a href="#">NActionRSP</a> this file defines the messages for the NAction action	724
<a href="#">gdcM::network::NCreateRQ</a>	
<a href="#">NCreateRQ</a>	726
<a href="#">gdcM::network::NCreateRSP</a>	
<a href="#">NCreateRSP</a> this file defines the messages for the ncreate action	727
<a href="#">gdcM::network::NDeleteRQ</a>	
<a href="#">NDeleteRQ</a>	729
<a href="#">gdcM::network::NDeleteRSP</a>	
<a href="#">NDeleteRSP</a> this file defines the messages for the ndelete action	730
<a href="#">gdcM::NestedModuleEntries</a>	
Class for representing a <a href="#">NestedModuleEntries</a>	732
<a href="#">gdcM::network::NEventReportRQ</a>	
<a href="#">NEventReportRQ</a>	735
<a href="#">gdcM::network::NEventReportRSP</a>	
<a href="#">NEventReportRSP</a> this file defines the messages for the neventreport action	736
<a href="#">gdcM::network::NGetRQ</a>	
<a href="#">NGetRQ</a>	738
<a href="#">gdcM::network::NGetRSP</a>	
<a href="#">NGetRSP</a> this file defines the messages for the nget action	739
<a href="#">gdcM::NoEvent</a>	741
<a href="#">gdcM::network::NormalizedMessageFactory</a>	742
<a href="#">gdcM::NormalizedNetworkFunctions</a>	
Normalized Network Functions	743
<a href="#">gdcM::network::NSetRQ</a>	
<a href="#">NSetRQ</a>	746
<a href="#">gdcM::network::NSetRSP</a>	
<a href="#">NSetRSP</a> this file defines the messages for the nset action	748
<a href="#">gdcM::Object</a>	
<a href="#">Object</a>	749
<a href="#">gdcM::OpenSSLCryptoFactory</a>	753
<a href="#">gdcM::OpenSSLCryptographicMessageSyntax</a>	755
<a href="#">gdcM::OpenSSLP7CryptoFactory</a>	758
<a href="#">gdcM::OpenSSLP7CryptographicMessageSyntax</a>	760
<a href="#">gdcM::Orientation</a>	
Class to handle <a href="#">Orientation</a>	763
<a href="#">gdcM::Overlay</a>	
<a href="#">Overlay</a> class	766
<a href="#">gdcM::ParseException</a>	
<a href="#">ParseException</a> Standard exception handling object	777
<a href="#">gdcM::Parser</a>	
<a href="#">Parser</a> ala XML_Parser from expat (SAX)	779
<a href="#">gdcM::Patient</a>	
See PS 3.3 - 2007 DICOM MODEL OF THE REAL-WORLD, p 54	784



gdcmm::network::PDataTFPDU	
PDataTFPDU	785
gdcmm::PDBElement	
Class to represent a PDB <a href="#">Element</a>	788
gdcmm::PDBHeader	
Class for <a href="#">PDBHeader</a>	791
gdcmm::PDFCodec	
PDFCodec class	794
gdcmm::network::PDUFactory	
PDUFactory basically, given an initial byte, construct the	797
gdcmm::PersonName	
PersonName class	800
gdcmm::PGXCodec	
Class to do PGX	803
gdcmm::PhotometricInterpretation	
Class to represent an <a href="#">PhotometricInterpretation</a>	806
gdcmm::PixelFormat	
PixelFormat	810
gdcmm::Pixmap	
Pixmap class	819
gdcmm::PixmapReader	
PixmapReader	825
gdcmm::PixmapToPixmapFilter	
PixmapToPixmapFilter class	829
gdcmm::PixmapWriter	
PixmapWriter	832
gdcmm::PNMCodec	
Class to do PNM	837
gdcmm::Preamble	
DICOM <a href="#">Preamble</a> (Part 10)	840
gdcmm::PresentationContext	
PresentationContext	845
gdcmm::network::PresentationContextAC	
PresentationContextAC	849
gdcmm::PresentationContextGenerator	
PresentationContextGenerator	851
gdcmm::network::PresentationContextRQ	
PresentationContextRQ	855
gdcmm::network::PresentationDataValue	
PresentationDataValue	859
gdcmm::Printer	
Printer class	863
gdcmm::PrivateDict	
Private <a href="#">Dict</a>	868
gdcmm::PrivateTag	
Class to represent a Private DICOM Data <a href="#">Element</a> ( <a href="#">Attribute</a> ) <a href="#">Tag</a> (Group, <a href="#">Element</a> , Owner)	871
gdcmm::ProgressEvent	
ProgressEvent	874
gdcmm::PVRGCodec	
PVRGCodec	878
gdcmm::PythonFilter	
PythonFilter <a href="#">PythonFilter</a> is the class that make gdcmm2.x looks more like gdcmm1 and transform the binary blob contained in a <a href="#">DataElement</a> into a string, typically this is a nice feature to have for wrapped language	881

gdcM::QueryBase	
QueryBase	883
gdcM::QueryFactory	
QueryFactory.h	886
gdcM::QueryImage	
QueryImage	888
gdcM::QueryPatient	
QueryPatient	890
gdcM::QuerySeries	
QuerySeries	893
gdcM::QueryStudy	
QueryStudy.h	895
gdcM::RAWCodec	
RAWCodec class	898
gdcM::Reader	
Reader ala DOM (Document Object Model)	902
gdcM::RealWorldValueMappingContent	910
gdcM::Region	
Class for manipulation region	911
gdcM::Rescaler	
Rescale class	914
gdcM::RLECodec	
Class to do RLE	919
gdcM::network::RoleSelectionSub	
RoleSelectionSub	925
gdcM::Scanner	
Scanner	927
gdcM::Segment	
This class defines a segment	936
gdcM::SegmentedPaletteColorLookupTable	
SegmentedPaletteColorLookupTable class	946
gdcM::SegmentReader	
This class defines a segment reader	949
gdcM::SegmentWriter	
This class defines a segment writer	953
gdcM::SequenceOfFragments	
Class to represent a Sequence Of Fragments	957
gdcM::SequenceOfItems	
Class to represent a Sequence Of Items	964
gdcM::SerieHelper	
SerieHelper DO NOT USE this class, it is only a temporary solution for ITK migration from GDCM 1.x to GDCM 2.x It will disappear soon, you've been warned	973
gdcM::Series	
Series	979
gdcM::network::ServiceClassApplicationInformation	980
gdcM::ServiceClassUser	
ServiceClassUser	982
gdcM::SHA1	
Class for SHA1	990
gdcM::SimpleMemberCommand< T >	
Command subclass that calls a pointer to a member function	992
gdcM::SimpleSubjectWatcher	
SimpleSubjectWatcher	997
gdcM::MrProtocol::Slice	1001

gdcm::MrProtocol::SliceArray	1002
gdcm::SmartPointer< ObjectType >	
Class for Smart Pointer	1003
gdcm::network::SOPClassExtendedNegociationSub	
SOPClassExtendedNegociationSub	1007
gdcm::SOPClassUIDToIOD	
Class convert a class SOP Class UID into IOD	1009
gdcm::Sorter	
Sorter	1011
gdcm::Spacing	
Class for Spacing	1016
gdcm::Spectroscopy	
Spectroscopy class	1018
gdcm::SplitMosaicFilter	
SplitMosaicFilter class	1019
gdcm::StartEvent	1023
gdcm::static_assert_test< x >	1024
gdcm::STATIC_ASSERTION_FAILURE< x >	1024
gdcm::STATIC_ASSERTION_FAILURE< true >	1024
gdcm::StreamImageReader	
StreamImageReader	1025
gdcm::StreamImageWriter	
StreamImageReader	1029
gdcm::StrictScanner	
StrictScanner	1036
gdcm::String< TDelimiter, TMaxLength, TPadChar >	
String	1045
gdcm::StringFilter	
StringFilter	1050
gdcm::Study	
Study	1055
gdcm::Subject	
Subject	1055
gdcm::Surface	
This class defines a SURFACE IE	1059
gdcm::SurfaceHelper	
SurfaceHelper	1074
gdcm::SurfaceReader	
This class defines a SURFACE IE reader	1077
gdcm::SurfaceWriter	
This class defines a SURFACE IE writer	1081
gdcm::SwapCode	
SwapCode representation	1084
gdcm::SwapperDoOp	1086
gdcm::SwapperNoOp	1087
gdcm::System	
Class to do system operation	1088
gdcm::Table	
Table	1096
gdcm::TableEntry	
TableEntry	1099
gdcm::TableReader	
Class for representing a TableReader	1100
gdcm::network::TableRow	1104

<a href="#">gdcM::Tag</a>	
Class to represent a DICOM Data <a href="#">Element</a> ( <a href="#">Attribute</a> ) <a href="#">Tag</a> ( <a href="#">Group</a> , <a href="#">Element</a> )	1105
<a href="#">gdcM::TagPath</a>	
Class to handle a path of tag	1116
<a href="#">gdcM::Testing</a>	
Class for testing	1119
<a href="#">gdcM::Trace</a>	
Trace	1127
<a href="#">gdcM::TransferSyntax</a>	
Class to manipulate Transfer Syntax	1132
<a href="#">gdcM::network::TransferSyntaxSub</a>	
TransferSyntaxSub	1139
<a href="#">gdcM::network::Transition</a>	1141
<a href="#">gdcM::Type</a>	
Type	1143
<a href="#">gdcM::UI</a>	1146
<a href="#">gdcM::UIDGenerator</a>	
Class for generating unique UID	1146
<a href="#">gdcM::UIDs</a>	
All known uids	1149
<a href="#">gdcM::network::ULAction</a>	
ULAction	1187
<a href="#">gdcM::network::ULActionAA1</a>	1190
<a href="#">gdcM::network::ULActionAA2</a>	1191
<a href="#">gdcM::network::ULActionAA3</a>	1192
<a href="#">gdcM::network::ULActionAA4</a>	1194
<a href="#">gdcM::network::ULActionAA5</a>	1195
<a href="#">gdcM::network::ULActionAA6</a>	1196
<a href="#">gdcM::network::ULActionAA7</a>	1198
<a href="#">gdcM::network::ULActionAA8</a>	1199
<a href="#">gdcM::network::ULActionAE1</a>	1200
<a href="#">gdcM::network::ULActionAE2</a>	1202
<a href="#">gdcM::network::ULActionAE3</a>	1203
<a href="#">gdcM::network::ULActionAE4</a>	1204
<a href="#">gdcM::network::ULActionAE5</a>	1206
<a href="#">gdcM::network::ULActionAE6</a>	1207
<a href="#">gdcM::network::ULActionAE7</a>	1208
<a href="#">gdcM::network::ULActionAE8</a>	1210
<a href="#">gdcM::network::ULActionAR1</a>	1211
<a href="#">gdcM::network::ULActionAR10</a>	1212
<a href="#">gdcM::network::ULActionAR2</a>	1214
<a href="#">gdcM::network::ULActionAR3</a>	1215
<a href="#">gdcM::network::ULActionAR4</a>	1216
<a href="#">gdcM::network::ULActionAR5</a>	1218
<a href="#">gdcM::network::ULActionAR6</a>	1219
<a href="#">gdcM::network::ULActionAR7</a>	1220
<a href="#">gdcM::network::ULActionAR8</a>	1222
<a href="#">gdcM::network::ULActionAR9</a>	1223
<a href="#">gdcM::network::ULActionDT1</a>	1224
<a href="#">gdcM::network::ULActionDT2</a>	1226
<a href="#">gdcM::network::ULBasicCallback</a>	
ULBasicCallback	1227
<a href="#">gdcM::network::ULConnection</a>	
ULConnection	1229

gdcm::network::ULConnectionCallback	1235
gdcm::network::ULConnectionInfo	
ULConnectionInfo	1238
gdcm::network::ULConnectionManager	
ULConnectionManager	1240
gdcm::network::ULEvent	
ULEvent	1248
gdcm::network::ULTransitionTable	
ULTransitionTable The transition table of all the ULEvents, new ULActions, and ULStates	1250
gdcm::network::ULWritingCallback	1252
gdcm::UNExplicitDataElement	
Class to read/write a <a href="#">DataElement</a> as UNExplicit Data <a href="#">Element</a>	1254
gdcm::UNExplicitImplicitDataElement	
Class to read/write a <a href="#">DataElement</a> as ExplicitImplicit Data <a href="#">Element</a>	1257
gdcm::Unpacker12Bits	
Pack/Unpack 12 bits pixel into 16bits	1259
gdcm::Usage	
Usage	1260
gdcm::UserEvent	1263
gdcm::network::UserInformation	
UserInformation	1264
gdcm::UUIDGenerator	
Class for generating unique UUID	1266
gdcm::Validate	
Validate class	1267
gdcm::Value	
Class to represent the value of a Data <a href="#">Element</a>	1270
gdcm::ValueIO< TDE, TSwap, TType >	
Class to dispatch template calls	1273
gdcm::MrProtocol::Vector3	1274
gdcm::Version	
Major/minor and build version	1274
gdcm::VL	
Value Length	1277
gdcm::VM	
Value Multiplicity Looking at the DICOMV3 dict only there is very few cases: 1 2 3 4 5 6 8 16 24 1-2 1-3 1-8 1-32 1-99 1-n 2-2n 2-n 3-3n 3-n	1281
gdcm::VMToLength< T >	1286
gdcm::VR	
VR class	1286
gdcm::VR16ExplicitDataElement	
Class to read/write a <a href="#">DataElement</a> as Explicit Data <a href="#">Element</a>	1294
gdcm::VRToEncoding< T >	1296
gdcm::VRToType< T >	1296
gdcm::VRVLSize< T >	1297
gdcm::VRVLSize< 0 >	1297
gdcm::VRVLSize< 1 >	1297
vtkGDCMImageReader	1298
vtkGDCMImageReader2	1313
vtkGDCMImageWriter	1328
vtkGDCMMedicalImageProperties	1337
vtkGDCMPolyDataReader	1340
vtkGDCMPolyDataWriter	1345
vtkGDCMTesting	1350

---

<a href="#">vtkGDCMThreadedImageReader</a>	1354
<a href="#">vtkGDCMThreadedImageReader2</a>	1358
<a href="#">vtkImageColorViewer</a>	1367
<a href="#">vtkImageMapToColors16</a>	1382
<a href="#">vtkImageMapToWindowLevelColors2</a>	1388
<a href="#">vtkImagePlanarComponentsToComponents</a>	1392
<a href="#">vtkImageRGBToYBR</a>	1394
<a href="#">vtkImageYBRToRGB</a>	1397
<a href="#">vtkLookupTable16</a>	1399
<a href="#">vtkRTStructSetProperties</a>	1403
<a href="#">gdcm::Waveform</a>	
<a href="#">Waveform</a> class	1414
<a href="#">gdcm::WLMFindQuery</a>	
<a href="#">PatientRootQuery</a>	1415
<a href="#">gdcm::Writer</a>	
<a href="#">Writer</a> ala DOM (Document <a href="#">Object</a> Model)	1418
<a href="#">gdcm::XMLDictReader</a>	
Class for representing a <a href="#">XMLDictReader</a>	1424
<a href="#">gdcm::XMLPrinter</a>	1427
<a href="#">gdcm::XMLPrivateDictReader</a>	
Class for representing a <a href="#">XMLPrivateDictReader</a>	1431

# Chapter 8

## File Index

### 8.1 File List

Here is a list of all files with brief descriptions:

<a href="#">gdcmAAbortPDU.h</a>	1435
<a href="#">gdcmAAssociateACPDU.h</a>	1436
<a href="#">gdcmAAssociateRJPDU.h</a>	1436
<a href="#">gdcmAAssociateRQPDU.h</a>	1437
<a href="#">gdcmAbstractSyntax.h</a>	1438
<a href="#">gdcmAnonymizeEvent.h</a>	1439
<a href="#">gdcmAnonymizer.h</a>	1440
<a href="#">gdcmApplicationContext.h</a>	1441
<a href="#">gdcmApplicationEntity.h</a>	1442
<a href="#">gdcmAReleaseRPPDU.h</a>	1442
<a href="#">gdcmAReleaseRQPDU.h</a>	1443
<a href="#">gdcmARTIMTimer.h</a>	1444
<a href="#">gdcmASN1.h</a>	1445
<a href="#">gdcmAsynchronousOperationsWindowSub.h</a>	1446
<a href="#">gdcmAttribute.h</a>	1446
<a href="#">gdcmAudioCodec.h</a>	1448
<a href="#">gdcmBase64.h</a>	1449
<a href="#">gdcmBaseCompositeMessage.h</a>	1449
<a href="#">gdcmBaseNormalizedMessage.h</a>	1450
<a href="#">gdcmBasePDU.h</a>	1451
<a href="#">gdcmBaseQuery.h</a>	1452
<a href="#">gdcmBaseRootQuery.h</a>	1453
<a href="#">gdcmBasicOffsetTable.h</a>	1454
<a href="#">gdcmBitmap.h</a>	1455
<a href="#">gdcmBitmapToBitmapFilter.h</a>	1456
<a href="#">gdcmBoxRegion.h</a>	1457
<a href="#">gdcmByteBuffer.h</a>	1457
<a href="#">gdcmByteSwap.h</a>	1459
<a href="#">gdcmByteSwapFilter.h</a>	1459
<a href="#">gdcmByteValue.h</a>	1460
<a href="#">gdcmCAPICryptoFactory.h</a>	1461

<a href="#">gdcmlCAPICryptographicMessageSyntax.h</a>	1462
<a href="#">gdcmlCEchoMessages.h</a>	1462
<a href="#">gdcmlCFindMessages.h</a>	1463
<a href="#">gdcmlCMoveMessages.h</a>	1464
<a href="#">gdcmlCodec.h</a>	1465
<a href="#">gdcmlCoder.h</a>	1466
<a href="#">gdcmlCodeString.h</a>	1468
<a href="#">gdcmlCommand.h</a>	1469
<a href="#">gdcmlCommandDataSet.h</a>	1470
<a href="#">gdcmlCompositeMessageFactory.h</a>	1471
<a href="#">gdcmlCompositeNetworkFunctions.h</a>	1471
<a href="#">gdcmlConstCharWrapper.h</a>	1472
<a href="#">gdcmlCP246ExplicitDataElement.h</a>	1472
<a href="#">gdcmlCryptoFactory.h</a>	1473
<a href="#">gdcmlCryptographicMessageSyntax.h</a>	1474
<a href="#">gdcmlCSAElement.h</a>	1475
<a href="#">gdcmlCSAHeader.h</a>	1476
<a href="#">gdcmlCSAHeaderDict.h</a>	1477
<a href="#">gdcmlCSAHeaderDictEntry.h</a>	1478
<a href="#">gdcmlCStoreMessages.h</a>	1479
<a href="#">gdcmlCurve.h</a>	1480
<a href="#">gdcmlDataElement.h</a>	1481
<a href="#">gdcmlDataEvent.h</a>	1483
<a href="#">gdcmlDataSet.h</a>	1484
<a href="#">gdcmlDataSetEvent.h</a>	1485
<a href="#">gdcmlDataSetHelper.h</a>	1485
<a href="#">gdcmlDecoder.h</a>	1486
<a href="#">gdcmlDefinedTerms.h</a>	1488
<a href="#">gdcmlDeflateStream.h</a>	1488
<a href="#">gdcmlDefs.h</a>	1489
<a href="#">gdcmlDeltaEncodingCodec.h</a>	1490
<a href="#">gdcmlDICOMDIR.h</a>	1491
<a href="#">gdcmlDICOMDIRGenerator.h</a>	1492
<a href="#">gdcmlDict.h</a>	1492
<a href="#">gdcmlDictConverter.h</a>	1494
<a href="#">gdcmlDictEntry.h</a>	1494
<a href="#">gdcmlDictPrinter.h</a>	1496
<a href="#">gdcmlDicts.h</a>	1496
<a href="#">gdcmlDIMSE.h</a>	1498
<a href="#">gdcmlDirectionCosines.h</a>	1498
<a href="#">gdcmlDirectory.h</a>	1499
<a href="#">gdcmlDirectoryHelper.h</a>	1500
<a href="#">gdcmlDummyValueGenerator.h</a>	1501
<a href="#">gdcmlDumper.h</a>	1502
<a href="#">gdcmlElement.h</a>	1502
<a href="#">gdcmlEmptyMaskGenerator.h</a>	1504
<a href="#">gdcmlEncapsulatedDocument.h</a>	1505
<a href="#">gdcmlEnumeratedValues.h</a>	1505
<a href="#">gdcmlEquipmentManufacturer.h</a>	1506
<a href="#">gdcmlEvent.h</a>	1507
<a href="#">gdcmlException.h</a>	1508
<a href="#">gdcmlExplicitDataElement.h</a>	1509
<a href="#">gdcmlExplicitImplicitDataElement.h</a>	1510
<a href="#">gdcmlFiducials.h</a>	1511



gdcmFile.h	1511
gdcmFileAnonymizer.h	1513
gdcmFileChangeTransferSyntax.h	1513
gdcmFileDecompressLookupTable.h	1514
gdcmFileDerivation.h	1515
gdcmFileExplicitFilter.h	1516
gdcmFileMetaInformation.h	1517
gdcmFilename.h	1518
gdcmFileNameEvent.h	1518
gdcmFilenameGenerator.h	1519
gdcmFileSet.h	1520
gdcmFileStreamer.h	1521
gdcmFindPatientRootQuery.h	1522
gdcmFindStudyRootQuery.h	1523
gdcmFragment.h	1523
gdcmGlobal.h	1525
gdcmGroupDict.h	1526
gdcmIconImage.h	1526
gdcmIconImageFilter.h	1527
gdcmIconImageGenerator.h	1528
gdcmImage.h	1529
gdcmImageApplyLookupTable.h	1530
gdcmImageChangePhotometricInterpretation.h	1531
gdcmImageChangePlanarConfiguration.h	1532
gdcmImageChangeTransferSyntax.h	1532
gdcmImageCodec.h	1533
gdcmImageConverter.h	1534
gdcmImageFragmentSplitter.h	1535
gdcmImageHelper.h	1536
gdcmImageReader.h	1537
gdcmImageRegionReader.h	1538
gdcmImageToImageFilter.h	1538
gdcmImageWriter.h	1539
gdcmImplementationClassUIDSub.h	1540
gdcmImplementationUIDSub.h	1541
gdcmImplementationVersionNameSub.h	1542
gdcmImplicitDataElement.h	1543
gdcmIOD.h	1544
gdcmIODEntry.h	1545
gdcmIODs.h	1547
gdcmIPPSorter.h	1548
gdcmItem.h	1549
gdcmJPEG12Codec.h	1551
gdcmJPEG16Codec.h	1551
gdcmJPEG2000Codec.h	1552
gdcmJPEG8Codec.h	1553
gdcmJPEGCodec.h	1554
gdcmJPEGLSCodec.h	1555
gdcmJSON.h	1555
gdcmKAKADUCodec.h	1556
gdcmLegacyMacro.h	1557
gdcmLO.h	1559
gdcmLookupTable.h	1559
gdcmMacro.h	1560

gdcmMacroEntry.h	1562
gdcmMacros.h	1564
gdcmMaximumLengthSub.h	1565
gdcmMD5.h	1567
gdcmMediaStorage.h	1567
gdcmMeshPrimitive.h	1569
gdcmModalityPerformedProcedureStepCreateQuery.h	1570
gdcmModalityPerformedProcedureStepSetQuery.h	1571
gdcmModule.h	1571
gdcmModuleEntry.h	1573
gdcmModules.h	1575
gdcmMovePatientRootQuery.h	1576
gdcmMoveStudyRootQuery.h	1577
gdcmMrProtocol.h	1577
gdcmNActionMessages.h	1579
gdcmNCreateMessages.h	1579
gdcmNDeleteMessages.h	1580
gdcmNestedModuleEntries.h	1581
gdcmNetworkEvents.h	1582
gdcmNetworkStateID.h	1583
gdcmNEventReportMessages.h	1584
gdcmNGetMessages.h	1585
gdcmNormalizedMessageFactory.h	1585
gdcmNormalizedNetworkFunctions.h	1586
gdcmNSetMessages.h	1587
gdcmObject.h	1587
gdcmOpenSSLCryptoFactory.h	1589
gdcmOpenSSLCryptographicMessageSyntax.h	1589
gdcmOpenSSLP7CryptoFactory.h	1591
gdcmOpenSSLP7CryptographicMessageSyntax.h	1591
gdcmOrientation.h	1593
gdcmOverlay.h	1593
gdcmParseException.h	1594
gdcmParser.h	1596
gdcmPatient.h	1596
gdcmPDataTFPDU.h	1597
gdcmPDBElement.h	1598
gdcmPDBHeader.h	1599
gdcmPDFCodec.h	1600
gdcmPDUFactory.h	1601
gdcmPersonName.h	1601
gdcmPGXCodec.h	1602
gdcmPhotometricInterpretation.h	1603
gdcmPixelFormat.h	1604
gdcmPixmap.h	1605
gdcmPixmapReader.h	1606
gdcmPixmapToPixmapFilter.h	1607
gdcmPixmapWriter.h	1607
gdcmPNMCodec.h	1609
gdcmPreamble.h	1609
gdcmPresentationContext.h	1611
gdcmPresentationContextAC.h	1612
gdcmPresentationContextGenerator.h	1613
gdcmPresentationContextRQ.h	1613

gdcmPresentationDataValue.h	1614
gdcmPrinter.h	1615
gdcmPrivateTag.h	1617
gdcmProgressEvent.h	1618
gdcmPVRGCodec.h	1619
gdcmPythonFilter.h	1619
gdcmQueryBase.h	1620
gdcmQueryFactory.h	1621
gdcmQueryImage.h	1622
gdcmQueryPatient.h	1623
gdcmQuerySeries.h	1624
gdcmQueryStudy.h	1625
gdcmRAWCodec.h	1626
gdcmReader.h	1626
gdcmRegion.h	1628
gdcmRescaler.h	1629
gdcmRLECodec.h	1630
gdcmRoleSelectionSub.h	1630
gdcmScanner.h	1631
gdcmSegment.h	1632
gdcmSegmentedPaletteColorLookupTable.h	1633
gdcmSegmentHelper.h	1634
gdcmSegmentReader.h	1635
gdcmSegmentWriter.h	1636
gdcmSequenceOfFragments.h	1637
gdcmSequenceOfItems.h	1638
gdcmSerieHelper.h	1638
gdcmSeries.h	1640
gdcmServiceClassApplicationInformation.h	1641
gdcmServiceClassUser.h	1642
gdcmSHA1.h	1642
gdcmSimpleSubjectWatcher.h	1643
gdcmSmartPointer.h	1644
gdcmSOPClassExtendedNegociationSub.h	1645
gdcmSOPClassUIDToIOD.h	1646
gdcmSorter.h	1647
gdcmSpacing.h	1649
gdcmSpectroscopy.h	1649
gdcmSplitMosaicFilter.h	1650
gdcmStaticAssert.h	1651
gdcmStreamImageReader.h	1653
gdcmStreamImageWriter.h	1653
gdcmStrictScanner.h	1654
gdcmString.h	1655
gdcmStringFilter.h	1656
gdcmStudy.h	1657
gdcmSubject.h	1658
gdcmSurface.h	1659
gdcmSurfaceHelper.h	1660
gdcmSurfaceReader.h	1661
gdcmSurfaceWriter.h	1662
gdcmSwapCode.h	1662
gdcmSwapper.h	1664
gdcmSystem.h	1665

gdcmTable.h	1665
gdcmTableEntry.h	1666
gdcmTableReader.h	1668
gdcmTag.h	1669
gdcmTagPath.h	1670
gdcmTagToVR.h	1670
gdcmTerminal.h	1671
gdcmTestDriver.h	1672
gdcmTesting.h	1673
gdcmTrace.h	1674
gdcmTransferSyntax.h	1678
gdcmTransferSyntaxSub.h	1680
gdcmType.h	1681
gdcmTypes.h	1682
gdcmUIDGenerator.h	1682
gdcmUIDs.h	1683
gdcmULAction.h	1684
gdcmULActionAA.h	1685
gdcmULActionAE.h	1685
gdcmULActionAR.h	1686
gdcmULActionDT.h	1687
gdcmULBasicCallback.h	1687
gdcmULConnection.h	1688
gdcmULConnectionCallback.h	1689
gdcmULConnectionInfo.h	1690
gdcmULConnectionManager.h	1691
gdcmULEvent.h	1692
gdcmULTransitionTable.h	1693
gdcmULWritingCallback.h	1694
gdcmUNExplicitDataElement.h	1695
gdcmUNExplicitImplicitDataElement.h	1695
gdcmUnpacker12Bits.h	1696
gdcmUsage.h	1697
gdcmUserInformation.h	1699
gdcmUUIIDGenerator.h	1700
gdcmValidate.h	1700
gdcmValue.h	1701
gdcmValueIO.h	1702
gdcmVersion.h	1702
gdcmVL.h	1703
gdcmVM.h	1704
gdcmVR.h	1705
gdcmVR16ExplicitDataElement.h	1707
gdcmWaveform.h	1708
gdcmWin32.h	1708
gdcmWLMFindQuery.h	1709
gdcmWriter.h	1710
gdcmXMLDictReader.h	1711
gdcmXMLPrinter.h	1711
gdcmXMLPrivateDictReader.h	1712
vtkGDCMImageReader.h	1713
vtkGDCMImageReader2.h	1715
vtkGDCMImageWriter.h	1716
vtkGDCMMedicalImageProperties.h	1717

---

<a href="#">vtkGDCMPolyDataReader.h</a>	1717
<a href="#">vtkGDCMPolyDataWriter.h</a>	1718
<a href="#">vtkGDCMTesting.h</a>	1719
<a href="#">vtkGDCMThreadedImageReader.h</a>	1719
<a href="#">vtkGDCMThreadedImageReader2.h</a>	1720
<a href="#">vtkImageColorViewer.h</a>	1720
<a href="#">vtkImageMapToColors16.h</a>	1721
<a href="#">vtkImageMapToWindowLevelColors2.h</a>	1721
<a href="#">vtkImagePlanarComponentsToComponents.h</a>	1722
<a href="#">vtkImageRGBToYBR.h</a>	1722
<a href="#">vtkImageYBRToRGB.h</a>	1723
<a href="#">vtkLookupTable16.h</a>	1723
<a href="#">vtkRTStructSetProperties.h</a>	1724



## Chapter 9

# Namespace Documentation

### 9.1 gdcM Namespace Reference

#### Namespaces

- [network](#)
- [SegmentHelper](#)
- [terminal](#)

*Class for Terminal.*

#### Classes

- class [AbortEvent](#)
- class [AnonymizeEvent](#)  
*AnonymizeEvent.*
- class [Anonymizer](#)  
*Anonymizer.*
- class [AnyEvent](#)
- class [ApplicationEntity](#)  
*ApplicationEntity.*
- class [ASN1](#)  
*Class for ASN1.*
- class [Attribute](#)  
*Attribute class This class use template metaprograming tricks to let the user know when the template instantiation does not match the public dictionary.*
- class [Attribute](#)< Group, Element, TVR, VM::VM1 >
- class [Attribute](#)< Group, Element, TVR, VM::VM1\_3 >
- class [Attribute](#)< Group, Element, TVR, VM::VM1\_8 >
- class [Attribute](#)< Group, Element, TVR, VM::VM1\_n >
- class [Attribute](#)< Group, Element, TVR, VM::VM2\_2n >
- class [Attribute](#)< Group, Element, TVR, VM::VM2\_n >
- class [Attribute](#)< Group, Element, TVR, VM::VM3\_3n >

- class [Attribute](#)< Group, Element, TVR, VM::VM3\_n >
- class [AudioCodec](#)  
*AudioCodec.*
- class [Base64](#)  
*Class for Base64.*
- class [BaseQuery](#)  
*BaseQuery.*
- class [BaseRootQuery](#)  
*BaseRootQuery.*
- class [BasicOffsetTable](#)  
*Class to represent a BasicOffsetTable.*
- class [Bitmap](#)  
*Bitmap class.*
- class [BitmapToBitmapFilter](#)  
*BitmapToBitmapFilter class.*
- class [BoxRegion](#)  
*Class for manipulation box region.*
- class [ByteBuffer](#)  
*ByteBuffer.*
- class [ByteSwap](#)  
*ByteSwap.*
- class [ByteSwapFilter](#)  
*ByteSwapFilter.*
- class [ByteValue](#)  
*Class to represent binary value (array of bytes)*
- class [CAPICryptoFactory](#)
- class [CAPICryptographicMessageSyntax](#)
- class [Codec](#)  
*Codec class.*
- class [Coder](#)  
*Coder.*
- class [CodeString](#)  
*CodeString.*
- class [Command](#)  
*Command superclass for callback/observer methods.*
- class [CommandDataSet](#)  
*Class to represent a Command DataSet.*
- class [CompositeNetworkFunctions](#)  
*Composite Network Functions.*
- class [ConstCharWrapper](#)  
*Do not use me.*
- class [CP246ExplicitDataElement](#)  
*Class to read/write a DataElement as CP246Explicit Data Element.*
- class [CryptoFactory](#)  
*Class to do handle the crypto factory.*
- class [CryptographicMessageSyntax](#)
- class [CSAElement](#)



- Class to represent a CSA [Element](#).*
- class [CSAHeader](#)
  - Class for [CSAHeader](#).*
- class [CSAHeaderDict](#)
  - Class to represent a map of [CSAHeaderDictEntry](#).*
- class [CSAHeaderDictEntry](#)
  - Class to represent an Entry in the [Dict](#).*
- class [CSAHeaderDictException](#)
- class [Curve](#)
  - [Curve](#) class to handle element 50xx,3000 [Curve](#) Data.*
- class [DataElement](#)
  - Class to represent a Data [Element](#) either Implicit or Explicit.*
- class [DataElementException](#)
- class [DataEvent](#)
  - [DataEvent](#).*
- class [DataSet](#)
  - Class to represent a Data Set (which contains Data Elements)*
- class [DataSetEvent](#)
  - [DataSetEvent](#).*
- class [DataSetHelper](#)
  - [DataSetHelper](#) (internal class, not intended for user level)*
- class [Decoder](#)
  - [Decoder](#).*
- class [DefinedTerms](#)
  - Defined Terms are used when the specified explicit Values may be extended by implementors to include additional new Values. These new Values shall be specified in the Conformance Statement (see PS 3.2) and shall not have the same meaning as currently defined Values in this standard. A Data [Element](#) with Defined Terms that does not contain a [Value](#) equivalent to one of the Values currently specified in this standard shall not be considered to have an invalid value. Note: Interpretation [Type](#) ID (4008,0210) is an example of a Data [Element](#) having Defined Terms. It is defined to have a [Value](#) that may be one of the set of standard Values; REPORT or AMENDMENT (see PS 3.3). Because this Data [Element](#) has Defined Terms other Interpretation [Type](#) IDs may be defined by the implementor.*
- class [Defs](#)
  - FIXME I do not like the name 'Defs'.*
- class [DeltaEncodingCodec](#)
  - [DeltaEncodingCodec](#) compression used by some private vendor.*
- class [DICOMDIR](#)
  - [DICOMDIR](#) class.*
- class [DICOMDIRGenerator](#)
  - [DICOMDIRGenerator](#) class.*
- class [Dict](#)
  - Class to represent a map of [DictEntry](#).*
- class [DictConverter](#)
  - Class to convert a .dic file into something else:*
- class [DictEntry](#)
  - Class to represent an Entry in the [Dict](#).*
- class [DictPrinter](#)
  - [DictPrinter](#) class.*
- class [Dicts](#)

*Class to manipulate the sum of knowledge (all the dict user load)*

- class [DirectionCosines](#)

*class to handle [DirectionCosines](#)*

- class [Directory](#)

*Class for manipulation directories.*

- class [DirectoryHelper](#)

*[DirectoryHelper](#).*

- class [DummyValueGenerator](#)

*Class for generating dummy value.*

- class [Dumper](#)

*Codec class.*

- class [Element](#)

*[Element](#) class.*

- class [Element](#)< TVR, VM::VM1\_2 >
- class [Element](#)< TVR, VM::VM1\_n >
- class [Element](#)< TVR, VM::VM2\_2n >
- class [Element](#)< TVR, VM::VM2\_n >
- class [Element](#)< TVR, VM::VM3\_3n >
- class [Element](#)< TVR, VM::VM3\_4 >
- class [Element](#)< TVR, VM::VM3\_n >
- class [Element](#)< VR::AS, VM::VM5 >
- class [Element](#)< VR::OB, VM::VM1 >
- class [Element](#)< VR::OW, VM::VM1 >
- class [ElementDisableCombinations](#)

*A class which is used to produce compile errors for an invalid combination of template parameters.*

- class [ElementDisableCombinations](#)< VR::OB, VM::VM1\_n >
- class [ElementDisableCombinations](#)< VR::OW, VM::VM1\_n >
- class [EmptyMaskGenerator](#)

*[EmptyMaskGenerator](#) Main class to generate a [Empty Mask Series](#) from an input [Series](#). This class takes an input folder and generates a series of DICOM files in the specified output directory. This class handles multiples DICOM [Series](#) within the same input directory.*

- class [EncapsulatedDocument](#)

*[EncapsulatedDocument](#).*

- class [EncodingImplementation](#)

*[EncodingImplementation](#).*

- class [EncodingImplementation](#)< VR::VRASCII >
- class [EncodingImplementation](#)< VR::VRBINARY >
- class [EndEvent](#)
- class [EnumeratedValues](#)

*[Element](#). A [Data Element](#) with [Enumerated Values](#) that does not have a [Value](#) equivalent to one of the [Values](#) specified in this standard has an invalid value within the scope of a specific [Information Object/SOP Class](#) definition. Note:*

- class [EquipmentManufacturer](#)
- class [Event](#)

*superclass for callback/observer methods*

- class [Exception](#)

*[Exception](#).*

- class [ExitEvent](#)

- class [ExplicitDataElement](#)

*Class to read/write a [DataElement](#) as [Explicit Data Element](#).*

- class [ExplicitImplicitDataElement](#)  
*Class to read/write a [DataElement](#) as [ExplicitImplicit Data Element](#).*
- class [Fiducials](#)  
*Fiducials.*
- class [File](#)  
*a DICOM File*
- class [FileAnonymizer](#)  
*FileAnonymizer.*
- class [FileChangeTransferSyntax](#)  
*FileChangeTransferSyntax.*
- class [FileDecompressLookupTable](#)  
*FileDecompressLookupTable class.*
- class [FileDerivation](#)  
*FileDerivation class.*
- class [FileExplicitFilter](#)  
*FileExplicitFilter class.*
- class [FileMetaInformation](#)  
*Class to represent a [File Meta Information](#).*
- class [Filename](#)  
*Class to manipulate file name's.*
- class [FileNameEvent](#)  
*FileNameEvent.*
- class [FilenameGenerator](#)  
*FilenameGenerator.*
- class [FileSet](#)
- class [FileStreamer](#)  
*FileStreamer.*
- class [FileWithName](#)  
*FileWithName.*
- class [FindPatientRootQuery](#)  
*PatientRootQuery.*
- class [FindStudyRootQuery](#)  
*FindStudyRootQuery.*
- class [Fragment](#)  
*Class to represent a [Fragment](#).*
- class [Global](#)  
*Global.*
- class [GroupDict](#)  
*Class to represent the mapping from group number to its abbreviation and name.*
- class [IconImageFilter](#)  
*IconImageFilter.*
- class [IconImageGenerator](#)  
*IconImageGenerator.*
- struct [ignore\\_char](#)
- class [Image](#)  
*Image.*
- class [ImageApplyLookupTable](#)

- *ImageApplyLookupTable* class.
- class [ImageChangePhotometricInterpretation](#)  
*ImageChangePhotometricInterpretation* class.
- class [ImageChangePlanarConfiguration](#)  
*ImageChangePlanarConfiguration* class.
- class [ImageChangeTransferSyntax](#)  
*ImageChangeTransferSyntax* class.
- class [ImageCodec](#)  
*ImageCodec*.
- class [ImageConverter](#)  
*Image Converter*.
- class [ImageFragmentSplitter](#)  
*ImageFragmentSplitter* class.
- class [ImageHelper](#)  
*ImageHelper* (internal class, not intended for user level)
- class [ImageReader](#)  
*ImageReader*.
- class [ImageRegionReader](#)  
*ImageRegionReader*.
- class [ImageToImageFilter](#)  
*ImageToImageFilter* class.
- class [ImageWriter](#)  
*ImageWriter*.
- class [ImplicitDataElement](#)  
*Class to represent an Implicit VR Data Element.*
- class [InitializeEvent](#)
- class [IOD](#)  
*Class for representing a IOD.*
- class [IODEntry](#)  
*Class for representing a IODEntry.*
- class [IODs](#)  
*Class for representing a IODs.*
- class [IPPSorter](#)  
*IPPSorter.*
- class [Item](#)  
*Class to represent an Item.*
- class [IterationEvent](#)
- class [JPEG12Codec](#)  
*Class to do JPEG 12bits (lossy & lossless)*
- class [JPEG16Codec](#)  
*Class to do JPEG 16bits (lossless)*
- class [JPEG2000Codec](#)  
*Class to do JPEG 2000.*
- class [JPEG8Codec](#)  
*Class to do JPEG 8bits (lossy & lossless)*
- class [JPEGCodec](#)  
*JPEG codec.*

- class [JPEGLSCodec](#)  
*JPEG-LS.*
- class [JSON](#)
- class [KAKADUCodec](#)  
*KAKADUCodec.*
- class [LO](#)  
*LO.*
- class [LookupTable](#)  
*LookupTable class.*
- class [Macro](#)  
*Class for representing a Macro.*
- class [Macros](#)  
*Class for representing a Modules.*
- class [MD5](#)  
*Class for MD5.*
- class [MediaStorage](#)  
*MediaStorage.*
- class [MemberCommand](#)  
*Command subclass that calls a pointer to a member function.*
- class [MeshPrimitive](#)  
*This class defines surface mesh primitives.*
- class [ModalityPerformedProcedureStepCreateQuery](#)  
*ModalityPerformedProcedureStepCreateQuery.*
- class [ModalityPerformedProcedureStepSetQuery](#)  
*ModalityPerformedProcedureStepSetQuery.*
- class [ModifiedEvent](#)
- class [Module](#)  
*Class for representing a Module.*
- class [ModuleEntry](#)  
*Class for representing a ModuleEntry.*
- class [Modules](#)  
*Class for representing a Modules.*
- class [MovePatientRootQuery](#)  
*MovePatientRootQuery.*
- class [MoveStudyRootQuery](#)  
*MoveStudyRootQuery.*
- class [MrProtocol](#)  
*Class for MrProtocol.*
- class [NestedModuleEntries](#)  
*Class for representing a NestedModuleEntries.*
- class [NoEvent](#)
- class [NormalizedNetworkFunctions](#)  
*Normalized Network Functions.*
- class [Object](#)  
*Object.*
- class [OpenSSLCryptoFactory](#)
- class [OpenSSLCryptographicMessageSyntax](#)

- class [OpenSSLP7CryptoFactory](#)
- class [OpenSSLP7CryptographicMessageSyntax](#)
- class [Orientation](#)
  - class to handle [Orientation](#)*
- class [Overlay](#)
  - [Overlay](#) class.*
- class [ParseException](#)
  - [ParseException](#) Standard exception handling object.*
- class [Parser](#)
  - [Parser](#) ala [XML\\_Parser](#) from [expat](#) (SAX)*
- class [Patient](#)
  - See [PS 3.3 - 2007 DICOM MODEL OF THE REAL-WORLD](#), p 54.*
- class [PDBElement](#)
  - Class to represent a [PDB Element](#).*
- class [PDBHeader](#)
  - Class for [PDBHeader](#).*
- class [PDFCodec](#)
  - [PDFCodec](#) class.*
- class [PersonName](#)
  - [PersonName](#) class.*
- class [PGXCodec](#)
  - Class to do [PGX](#).*
- class [PhotometricInterpretation](#)
  - Class to represent an [PhotometricInterpretation](#).*
- class [PixelFormat](#)
  - [PixelFormat](#).*
- class [Pixmap](#)
  - [Pixmap](#) class.*
- class [PixmapReader](#)
  - [PixmapReader](#).*
- class [PixmapToPixmapFilter](#)
  - [PixmapToPixmapFilter](#) class.*
- class [PixmapWriter](#)
  - [PixmapWriter](#).*
- class [PNMCodec](#)
  - Class to do [PNM](#).*
- class [Preamble](#)
  - [DICOM Preamble](#) (Part 10)*
- class [PresentationContext](#)
  - [PresentationContext](#).*
- class [PresentationContextGenerator](#)
  - [PresentationContextGenerator](#).*
- class [Printer](#)
  - [Printer](#) class.*
- class [PrivateDict](#)
  - Private [Dict](#).*
- class [PrivateTag](#)

*Class to represent a Private DICOM Data [Element \(Attribute\) Tag](#) (Group, [Element](#), Owner)*

- class [ProgressEvent](#)  
*ProgressEvent.*
- class [PVRGCodec](#)  
*PVRGCodec.*
- class [PythonFilter](#)  
*PythonFilter PythonFilter is the class that make gdcM2.x looks more like gdcM1 and transform the binary blob contained in a [DataElement](#) into a string, typically this is a nice feature to have for wrapped language.*
- class [QueryBase](#)  
*QueryBase.*
- class [QueryFactory](#)  
*QueryFactory.h.*
- class [QueryImage](#)  
*QueryImage.*
- class [QueryPatient](#)  
*QueryPatient.*
- class [QuerySeries](#)  
*QuerySeries.*
- class [QueryStudy](#)  
*QueryStudy.h.*
- class [RAWCodec](#)  
*RAWCodec class.*
- class [Reader](#)  
*Reader ala DOM (Document [Object Model](#))*
- struct [RealWorldValueMappingContent](#)
- class [Region](#)  
*Class for manipulation region.*
- class [Rescaler](#)  
*Rescale class.*
- class [RLECodec](#)  
*Class to do RLE.*
- class [Scanner](#)  
*Scanner.*
- class [Segment](#)  
*This class defines a segment.*
- class [SegmentedPaletteColorLookupTable](#)  
*SegmentedPaletteColorLookupTable class.*
- class [SegmentReader](#)  
*This class defines a segment reader.*
- class [SegmentWriter](#)  
*This class defines a segment writer.*
- class [SequenceOfFragments](#)  
*Class to represent a Sequence Of Fragments.*
- class [SequenceOfItems](#)  
*Class to represent a Sequence Of Items.*
- class [SerieHelper](#)  
*SerieHelper DO NOT USE this class, it is only a temporary solution for ITK migration from GDCM 1.x to GDCM 2.x It will disappear soon, you've been warned.*

- class [Series](#)  
*Series.*
- class [ServiceClassUser](#)  
*ServiceClassUser.*
- class [SHA1](#)  
*Class for SHA1.*
- class [SimpleMemberCommand](#)  
*Command subclass that calls a pointer to a member function.*
- class [SimpleSubjectWatcher](#)  
*SimpleSubjectWatcher.*
- class [SmartPointer](#)  
*Class for Smart Pointer.*
- class [SOPClassUIDToIOD](#)  
*Class convert a class SOP Class UID into IOD.*
- class [Sorter](#)  
*Sorter.*
- class [Spacing](#)  
*Class for Spacing.*
- class [Spectroscopy](#)  
*Spectroscopy class.*
- class [SplitMosaicFilter](#)  
*SplitMosaicFilter class.*
- class [StartEvent](#)
- struct [static\\_assert\\_test](#)
- struct [STATIC\\_ASSERTION\\_FAILURE](#)
- struct [STATIC\\_ASSERTION\\_FAILURE< true >](#)
- class [StreamImageReader](#)  
*StreamImageReader.*
- class [StreamImageWriter](#)  
*StreamImageReader.*
- class [StrictScanner](#)  
*StrictScanner.*
- class [String](#)  
*String.*
- class [StringFilter](#)  
*StringFilter.*
- class [Study](#)  
*Study.*
- class [Subject](#)  
*Subject.*
- class [Surface](#)  
*This class defines a SURFACE IE.*
- class [SurfaceHelper](#)  
*SurfaceHelper.*
- class [SurfaceReader](#)  
*This class defines a SURFACE IE reader.*
- class [SurfaceWriter](#)



*This class defines a SURFACE IE writer.*

- class [SwapCode](#)  
*SwapCode representation.*
- class [SwapperDoOp](#)
- class [SwapperNoOp](#)
- class [System](#)  
*Class to do system operation.*
- class [Table](#)  
*Table.*
- class [TableEntry](#)  
*TableEntry.*
- class [TableReader](#)  
*Class for representing a TableReader.*
- class [Tag](#)  
*Class to represent a DICOM Data [Element \(Attribute\) Tag \(Group, Element\)](#).*
- class [TagPath](#)  
*class to handle a path of tag.*
- class [Testing](#)  
*class for testing*
- class [Trace](#)  
*Trace.*
- class [TransferSyntax](#)  
*Class to manipulate Transfer Syntax.*
- class [Type](#)  
*Type.*
- struct [UI](#)
- class [UIDGenerator](#)  
*Class for generating unique UID.*
- class [UIDs](#)  
*all known uids*
- class [UNExplicitDataElement](#)  
*Class to read/write a [DataElement](#) as UNExplicit Data [Element](#).*
- class [UNExplicitImplicitDataElement](#)  
*Class to read/write a [DataElement](#) as ExplicitImplicit Data [Element](#).*
- class [Unpacker12Bits](#)  
*Pack/Unpack 12 bits pixel into 16bits.*
- class [Usage](#)  
*Usage.*
- class [UserEvent](#)
- class [UUIIDGenerator](#)  
*Class for generating unique UUIID.*
- class [Validate](#)  
*Validate class.*
- class [Value](#)  
*Class to represent the value of a Data [Element](#).*
- class [ValueIO](#)  
*Class to dispatch template calls.*

- class [Version](#)  
*major/minor and build version*
- class [VL](#)  
*Value Length.*
- class [VM](#)  
*Value Multiplicity Looking at the DICOMV3 dict only there is very few cases: 1 2 3 4 5 6 8 16 24 1-2 1-3 1-8 1-32 1-99 1-n 2-2n 2-n 3-3n 3-n.*
- struct [VMToLength](#)
- class [VR](#)  
*VR class.*
- class [VR16ExplicitDataElement](#)  
*Class to read/write a [DataElement](#) as Explicit Data [Element](#).*
- struct [VRToEncoding](#)
- struct [VRToType](#)
- class [VRVLSize](#)
- class [VRVLSize< 0 >](#)
- class [VRVLSize< 1 >](#)
- class [Waveform](#)  
*Waveform class.*
- class [WLMFindQuery](#)  
*PatientRootQuery.*
- class [Writer](#)  
*Writer ala DOM (Document [Object Model](#))*
- class [XMLDictReader](#)  
*Class for representing a [XMLDictReader](#).*
- class [XMLPrinter](#)
- class [XMLPrivateDictReader](#)  
*Class for representing a [XMLPrivateDictReader](#).*

## Typedefs

- typedef [String<'\', 16 >](#) [AECComp](#)
- typedef [String<'\', 64 >](#) [ASComp](#)
- typedef [bool\(\\* \[BOOL\\\_FUNCTION\\\_PFILE\\\_PFILE\\\_POINTER\]\(#\)\) \(File \\*, File \\*\)](#)
- typedef [String<'\', 16 >](#) [CSCComp](#)
- typedef [String<'\', 64 >](#) [DACComp](#)
- typedef [String<'\', 64 >](#) [DTComp](#)
- typedef [std::vector< \[SmartPointer< \\[FileWithName >\\]\\(#\\) >\]\(#\)](#) [FileList](#)
- typedef [Bitmap \[IconImage\]\(#\)](#)
- typedef [String<'\', 64 >](#) [LOComp](#)
- typedef [String<'\', 64 >](#) [LTComp](#)
- typedef [ModuleEntry \[MacroEntry\]\(#\)](#)
- typedef [NestedModuleEntries \[NestedMacroEntries\]\(#\)](#)
- typedef [String<'\', 64 >](#) [PNComp](#)
- typedef [String<'\', 64 >](#) [SHComp](#)
- typedef [String<'\', 64 >](#) [STComp](#)
- typedef [String<'\', 16 >](#) [TMComp](#)
- typedef [String<'\', 4294967294 >](#) [UCComp](#)
- typedef [String<'\', 64, 0 >](#) [UIComp](#)
- typedef [String<'\', 4294967294 >](#) [URComp](#)
- typedef [String<'\', 64 >](#) [UTCComp](#)

## Enumerations

- enum `CompOperators` {  
    `GDCM_EQUAL` = 0 ,  
    `GDCM_DIFFERENT` ,  
    `GDCM_GREATER` ,  
    `GDCM_GREATEROREQUAL` ,  
    `GDCM_LESS` ,  
    `GDCM_LESOREQUAL` }
- enum `ECharSet` {  
    `eLatin1` = 0 ,  
    `eLatin2` ,  
    `eLatin3` ,  
    `eLatin4` ,  
    `eCyrillic` ,  
    `eArabic` ,  
    `eGreek` ,  
    `eHebrew` ,  
    `eLatin5` ,  
    `eJapanese` ,  
    `eThai` ,  
    `eJapaneseKanjiMultibyte` ,  
    `eJapaneseSupplementaryKanjiMultibyte` ,  
    `eKoreanHangulHanjaMultibyte` ,  
    `eUTF8` ,  
    `eGB18030` }
- enum `ENQueryType` {  
    `eCreateMMPS` = 0 ,  
    `eSetMMPS` }
- enum `EQueryLevel` {  
    `ePatient` = 0 ,  
    `eStudy` = 1 ,  
    `eSeries` = 2 ,  
    `eImage` = 3 }
- enum `EQueryType` {  
    `eFind` = 0 ,  
    `eMove` ,  
    `eWLMFind` }
- enum `ERootType` {  
    `ePatientRootType` ,  
    `eStudyRootType` }
- enum `LodModeType` {  
    `LD_ALL` = 0x00000000 ,  
    `LD_NOSEQ` = 0x00000001 ,  
    `LD_NOSHADOW` = 0x00000002 ,  
    `LD_NOSHADOWSEQ` = 0x00000004 }

## Functions

- static int `add1` (char \*buf, int n)
- `ignore_char` const `backslash` ("\\")
- template<typename T >  
    static T `Clamp` (int v)

- static void [clean](#) (char \*mant)
- static int [doround](#) (char \*buf, unsigned int n)
- [VR::VRType GetVRFromTag](#) ([Tag](#) const &tag)
- bool [operator!=](#) (const [CodeString](#) &ref, const [CodeString](#) &cs)
- bool [operator!=](#) (const [DataElement](#) &lhs, const [DataElement](#) &rhs)
- std::ostream & [operator<<](#) (std::ostream &\_os, const [GroupDict](#) &\_val)
- std::ostream & [operator<<](#) (std::ostream &\_os, const [IOD](#) &\_val)
- std::ostream & [operator<<](#) (std::ostream &\_os, const [IODEntry](#) &\_val)
- std::ostream & [operator<<](#) (std::ostream &\_os, const [IODs](#) &\_val)
- std::ostream & [operator<<](#) (std::ostream &\_os, const [Macro](#) &\_val)
- std::ostream & [operator<<](#) (std::ostream &\_os, const [Macros](#) &\_val)
- std::ostream & [operator<<](#) (std::ostream &\_os, const [MediaStorage](#) &ms)
- std::ostream & [operator<<](#) (std::ostream &\_os, const [Module](#) &\_val)
- std::ostream & [operator<<](#) (std::ostream &\_os, const [ModuleEntry](#) &\_val)
- std::ostream & [operator<<](#) (std::ostream &\_os, const [Modules](#) &\_val)
- std::ostream & [operator<<](#) (std::ostream &\_os, const [NestedModuleEntries](#) &\_val)
- std::ostream & [operator<<](#) (std::ostream &\_os, const [Tag](#) &\_val)
- std::ostream & [operator<<](#) (std::ostream &\_os, const [TransferSyntax](#) &ts)
- std::ostream & [operator<<](#) (std::ostream &\_os, const [Type](#) &val)
- std::ostream & [operator<<](#) (std::ostream &\_os, const [UI](#) &\_val)
- std::ostream & [operator<<](#) (std::ostream &\_os, const [UIDs](#) &uid)
- std::ostream & [operator<<](#) (std::ostream &\_os, const [Usage](#) &val)
- std::ostream & [operator<<](#) (std::ostream &\_os, const [VM](#) &\_val)
- std::ostream & [operator<<](#) (std::ostream &\_os, const [VR](#) &val)
- std::ostream & [operator<<](#) (std::ostream &os, const [BasicOffsetTable](#) &val)
- std::ostream & [operator<<](#) (std::ostream &os, const [CodeString](#) &str)
- std::ostream & [operator<<](#) (std::ostream &os, const [CommandDataSet](#) &val)
- std::ostream & [operator<<](#) (std::ostream &os, const [CSAElement](#) &val)
- std::ostream & [operator<<](#) (std::ostream &os, const [CSAHeader](#) &d)
- std::ostream & [operator<<](#) (std::ostream &os, const [CSAHeaderDict](#) &val)
- std::ostream & [operator<<](#) (std::ostream &os, const [CSAHeaderDictEntry](#) &val)
- std::ostream & [operator<<](#) (std::ostream &os, const [DataElement](#) &val)
- std::ostream & [operator<<](#) (std::ostream &os, const [DataSet](#) &val)
- std::ostream & [operator<<](#) (std::ostream &os, const [Dict](#) &val)
- std::ostream & [operator<<](#) (std::ostream &os, const [DictEntry](#) &val)
- std::ostream & [operator<<](#) (std::ostream &os, const [Dicts](#) &d)
- std::ostream & [operator<<](#) (std::ostream &os, const [Directory](#) &d)
- std::ostream & [operator<<](#) (std::ostream &os, const [File](#) &val)
- std::ostream & [operator<<](#) (std::ostream &os, const [FileMetaInformation](#) &val)
- std::ostream & [operator<<](#) (std::ostream &os, const [FileSet](#) &f)
- std::ostream & [operator<<](#) (std::ostream &os, const [Fragment](#) &val)
- std::ostream & [operator<<](#) (std::ostream &os, const [Global](#) &g)
- std::ostream & [operator<<](#) (std::ostream &os, const [Item](#) &val)
- std::ostream & [operator<<](#) (std::ostream &os, const [MrProtocol](#) &d)
- std::ostream & [operator<<](#) (std::ostream &os, const [Object](#) &obj)
- std::ostream & [operator<<](#) (std::ostream &os, const [Orientation](#) &o)
- std::ostream & [operator<<](#) (std::ostream &os, const [PDBElement](#) &val)
- std::ostream & [operator<<](#) (std::ostream &os, const [PDBHeader](#) &d)
- std::ostream & [operator<<](#) (std::ostream &os, const [PhotometricInterpretation](#) &val)
- std::ostream & [operator<<](#) (std::ostream &os, const [PixelFormat](#) &pf)
- std::ostream & [operator<<](#) (std::ostream &os, const [Preamble](#) &val)

- `std::ostream & operator<<` (`std::ostream &os`, `const PrivateDict &val`)
- `std::ostream & operator<<` (`std::ostream &os`, `const PrivateTag &val`)
- `std::ostream & operator<<` (`std::ostream &os`, `const Region &r`)
- `std::ostream & operator<<` (`std::ostream &os`, `const Scanner &s`)
- `std::ostream & operator<<` (`std::ostream &os`, `const Sorter &s`)
- `std::ostream & operator<<` (`std::ostream &os`, `const StrictScanner &s`)
- `std::ostream & operator<<` (`std::ostream &os`, `const SwapCode &sc`)
- `std::ostream & operator<<` (`std::ostream &os`, `const Version &v`)
- `std::ostream & operator<<` (`std::ostream &os`, `const VL &val`)
- `std::ostream & operator<<` (`std::ostream &os`, `Event &e`)
  - *Generic inserter operator for `Event` and its subclasses.*
- `bool operator==` (`const CodeString &ref`, `const CodeString &cs`)
- `std::istream & operator>>` (`std::istream &_is`, `Tag &_val`)
- `std::istream & operator>>` (`std::istream &in`, `ignore_char const &ic`)
- `template<char TDelimiter, unsigned int TMaxLength, char TPadChar>`  
`std::istream & operator>>` (`std::istream &is`, `String< TDelimiter, TMaxLength, TPadChar > &ms`)
- `template<typename T >`  
`static int Round` (`T x`)
- `static int roundat` (`char *buf`, `unsigned int i`, `int iexp`)
- `TYPETOENCODING` (`SQ`, `VRBINARY`, `unsigned char`) `TYPETOENCODING`(`UN`)
- `template<typename Float >`  
`static void x16printf` (`char *buf`, `int size`, `Float f`)

## Variables

- `static Global GlobalInstance`
- `VRBINARY`

### 9.1.1 Detailed Description

This header defines the classes for the AA Actions, Association Abort Related Actions ([Table 9-9 of ps 3.8-2009](#)).

Since each class is essentially a placeholder for a function pointer, I'm breaking with having each class have its own file for the sake of brevity of the number of files.

This header defines the classes for the AE Actions, Association Establishment Related Actions ([Table 9-6 of ps 3.8-2009](#)).

Since each class is essentially a placeholder for a function pointer, I'm breaking with having each class have its own file for the sake of brevity of the number of files.

This header defines the classes for the AR Actions, Association Release Related Actions ([Table 9-8 of ps 3.8-2009](#)).

Since each class is essentially a placeholder for a function pointer, I'm breaking with having each class have its own file for the sake of brevity of the number of files.

This header defines the classes for the DT Actions, Data Transfer Related Actions ([Table 9-8 of ps 3.8-2009](#)).

Since each class is essentially a placeholder for a function pointer, I'm breaking with having each class have its own file for the sake of brevity of the number of files.

## 9.1.2 Typedef Documentation

### 9.1.2.1 AComp

```
typedef String<'\\',16> gdc::AComp
```

### 9.1.2.2 AComp

```
typedef String<'\\',64> gdc::AComp
```

### 9.1.2.3 BOOL\_FUNCTION\_PFILE\_PFILE\_POINTER

```
typedef bool(* gdc::BOOL\_FUNCTION\_PFILE\_PFILE\_POINTER) (File *, File *)
```

### 9.1.2.4 CComp

```
typedef String<'\\',16> gdc::CComp
```

### 9.1.2.5 DComp

```
typedef String<'\\',64> gdc::DComp
```

### 9.1.2.6 DComp

```
typedef String<'\\',64> gdc::DComp
```

### 9.1.2.7 FileList

```
typedef std::vector< SmartPointer<FileWithName> > gdcm::FileList
```

### 9.1.2.8 IconImage

```
typedef Bitmap gdcm::IconImage
```

### 9.1.2.9 LOComp

```
typedef String<'\\', 64> gdcm::LOComp
```

### 9.1.2.10 LTComp

```
typedef String<'\\', 64> gdcm::LTComp
```

### 9.1.2.11 MacroEntry

```
typedef ModuleEntry gdcm::MacroEntry
```

### 9.1.2.12 NestedMacroEntries

```
typedef NestedModuleEntries gdcm::NestedMacroEntries
```

### 9.1.2.13 PNComp

```
typedef String<'\\', 64> gdcm::PNComp
```

#### 9.1.2.14 SHComp

```
typedef String<'\\', 64> gdcm::SHComp
```

#### 9.1.2.15 STComp

```
typedef String<'\\', 64> gdcm::STComp
```

#### 9.1.2.16 TMComp

```
typedef String<'\\', 16> gdcm::TMComp
```

#### 9.1.2.17 UCComp

```
typedef String<'\\', 4294967294> gdcm::UCComp
```

#### 9.1.2.18 UIComp

```
typedef String<'\\', 64, 0> gdcm::UIComp
```

#### 9.1.2.19 URComp

```
typedef String<'\\', 4294967294> gdcm::URComp
```

#### 9.1.2.20 UTComp

```
typedef String<'\\', 64> gdcm::UTComp
```

### 9.1.3 Enumeration Type Documentation

#### 9.1.3.1 CompOperators

```
enum gdcm::CompOperators
```



## Enumerator

GDCM_EQUAL	
GDCM_DIFFERENT	
GDCM_GREATER	
GDCM_GREATEROREQUAL	
GDCM_LESS	
GDCM_LESOREQUAL	

## 9.1.3.2 ECharSet

```
enum gdcM::ECharSet
```

The character sets enumerated in PS 3.3 2009 Annex C, section C.12.1.1.2 The resulting character set is stored in 0008,0005 The conversion to the data element is performed by the [QueryFactory](#) itself

## Enumerator

eLatin1	
eLatin2	
eLatin3	
eLatin4	
eCyrillic	
eArabic	
eGreek	
eHebrew	
eLatin5	
eJapanese	
eThai	
eJapaneseKanjiMultibyte	
eJapaneseSupplementaryKanjiMultibyte	
eKoreanHangulHanjaMultibyte	
eUTF8	
eGB18030	

## 9.1.3.3 ENQueryType

```
enum gdcM::ENQueryType
```

**Enumerator**

eCreateMMPS	
eSetMMPS	

**9.1.3.4 EQueryLevel**

enum `gdcm::EQueryLevel`

**Enumerator**

ePatient	
eStudy	
eSeries	
eImage	

**9.1.3.5 EQueryType**

enum `gdcm::EQueryType`

**Enumerator**

eFind	
eMove	
eWLMFind	

**9.1.3.6 ERootType**

enum `gdcm::ERootType`

**Enumerator**

ePatientRootType	
eStudyRootType	

### 9.1.3.7 LodModeType

enum `gdcm::LodModeType`

#### Enumerator

LD_ALL	
LD_NOSEQ	
LD_NOSHADOW	
LD_NOSHADOWSEQ	

## 9.1.4 Function Documentation

### 9.1.4.1 add1()

```
static int gdcm::add1 (  
    char * buf,  
    int n ) [static]
```

Referenced by `doround()`.

### 9.1.4.2 backslash()

```
ignore_char const gdcm::backslash (  
    '\\ ' )
```

Referenced by `gdcm::EncodingImplementation< VR::VRASCII >::ReadComputeLength()`.

### 9.1.4.3 Clamp()

```
template<typename T >  
static T gdcm::Clamp (  
    int v ) [inline], [static]
```

#### 9.1.4.4 clean()

```
static void gdcM::clean (
    char * mant ) [inline], [static]
```

Referenced by x16printf().

#### 9.1.4.5 doround()

```
static int gdcM::doround (
    char * buf,
    unsigned int n ) [static]
```

References add1().

Referenced by roundat().

#### 9.1.4.6 GetVRFromTag()

```
VR::VRType gdcM::GetVRFromTag (
    Tag const & tag )
```

#### 9.1.4.7 operator"!="() [1/2]

```
bool gdcM::operator!= (
    const CodeString & ref,
    const CodeString & cs ) [inline]
```

#### 9.1.4.8 operator"!="() [2/2]

```
bool gdcM::operator!= (
    const DataElement & lhs,
    const DataElement & rhs ) [inline]
```

**9.1.4.9 operator<<()** [1/56]

```
std::ostream& gdcM::operator<< (
    std::ostream & _os,
    const GroupDict & _val ) [inline]
```

**9.1.4.10 operator<<()** [2/56]

```
std::ostream& gdcM::operator<< (
    std::ostream & _os,
    const IOD & _val ) [inline]
```

**9.1.4.11 operator<<()** [3/56]

```
std::ostream& gdcM::operator<< (
    std::ostream & _os,
    const IOEntry & _val ) [inline]
```

**9.1.4.12 operator<<()** [4/56]

```
std::ostream& gdcM::operator<< (
    std::ostream & _os,
    const IODs & _val ) [inline]
```

**9.1.4.13 operator<<()** [5/56]

```
std::ostream& gdcM::operator<< (
    std::ostream & _os,
    const Macro & _val ) [inline]
```

**9.1.4.14 operator<<()** [6/56]

```
std::ostream& gdcM::operator<< (
    std::ostream & _os,
    const Macros & _val ) [inline]
```

#### 9.1.4.15 operator<<() [7/56]

```
std::ostream& gdcmm::operator<< (
    std::ostream & _os,
    const MediaStorage & ms ) [inline]
```

#### 9.1.4.16 operator<<() [8/56]

```
std::ostream& gdcmm::operator<< (
    std::ostream & _os,
    const Module & _val ) [inline]
```

#### 9.1.4.17 operator<<() [9/56]

```
std::ostream& gdcmm::operator<< (
    std::ostream & _os,
    const ModuleEntry & _val ) [inline]
```

#### 9.1.4.18 operator<<() [10/56]

```
std::ostream& gdcmm::operator<< (
    std::ostream & _os,
    const Modules & _val ) [inline]
```

#### 9.1.4.19 operator<<() [11/56]

```
std::ostream& gdcmm::operator<< (
    std::ostream & _os,
    const NestedModuleEntries & _val ) [inline]
```

#### 9.1.4.20 operator<<() [12/56]

```
std::ostream& gdcmm::operator<< (
    std::ostream & _os,
    const Tag & _val ) [inline]
```

**9.1.4.21 operator<<()** [13/56]

```
std::ostream& gdcM::operator<< (
    std::ostream & _os,
    const TransferSyntax & ts ) [inline]
```

**9.1.4.22 operator<<()** [14/56]

```
std::ostream& gdcM::operator<< (
    std::ostream & _os,
    const Type & val ) [inline]
```

**9.1.4.23 operator<<()** [15/56]

```
std::ostream& gdcM::operator<< (
    std::ostream & _os,
    const UI & _val ) [inline]
```

**9.1.4.24 operator<<()** [16/56]

```
std::ostream& gdcM::operator<< (
    std::ostream & _os,
    const UIDs & uid ) [inline]
```

References [gdcM::UIDs::GetName\(\)](#), and [gdcM::UIDs::GetString\(\)](#).

**9.1.4.25 operator<<()** [17/56]

```
std::ostream& gdcM::operator<< (
    std::ostream & _os,
    const Usage & val ) [inline]
```

**9.1.4.26 operator<<()** [18/56]

```
std::ostream& gdcmm::operator<< (
    std::ostream & _os,
    const VM & _val ) [inline]
```

**9.1.4.27 operator<<()** [19/56]

```
std::ostream& gdcmm::operator<< (
    std::ostream & _os,
    const VR & val ) [inline]
```

**9.1.4.28 operator<<()** [20/56]

```
std::ostream& gdcmm::operator<< (
    std::ostream & os,
    const BasicOffsetTable & val ) [inline]
```

**9.1.4.29 operator<<()** [21/56]

```
std::ostream& gdcmm::operator<< (
    std::ostream & os,
    const CodeString & str ) [inline]
```

**9.1.4.30 operator<<()** [22/56]

```
std::ostream& gdcmm::operator<< (
    std::ostream & os,
    const CommandDataSet & val ) [inline]
```

**9.1.4.31 operator<<()** [23/56]

```
std::ostream& gdcmm::operator<< (
    std::ostream & os,
    const CSAElement & val ) [inline]
```



**9.1.4.32 operator<<()** [24/56]

```
std::ostream& gdcM::operator<< (
    std::ostream & os,
    const CSAHeader & d ) [inline]
```

**9.1.4.33 operator<<()** [25/56]

```
std::ostream& gdcM::operator<< (
    std::ostream & os,
    const CSAHeaderDict & val ) [inline]
```

**9.1.4.34 operator<<()** [26/56]

```
std::ostream& gdcM::operator<< (
    std::ostream & os,
    const CSAHeaderDictEntry & val ) [inline]
```

**9.1.4.35 operator<<()** [27/56]

```
std::ostream& gdcM::operator<< (
    std::ostream & os,
    const DataElement & val ) [inline]
```

**9.1.4.36 operator<<()** [28/56]

```
std::ostream& gdcM::operator<< (
    std::ostream & os,
    const DataSet & val ) [inline]
```

**9.1.4.37 operator<<()** [29/56]

```
std::ostream& gdcM::operator<< (
    std::ostream & os,
    const Dict & val ) [inline]
```

#### 9.1.4.38 operator<<() [30/56]

```
std::ostream& gdcmm::operator<< (
    std::ostream & os,
    const DictEntry & val ) [inline]
```

#### 9.1.4.39 operator<<() [31/56]

```
std::ostream& gdcmm::operator<< (
    std::ostream & os,
    const Dicts & d ) [inline]
```

#### 9.1.4.40 operator<<() [32/56]

```
std::ostream& gdcmm::operator<< (
    std::ostream & os,
    const Directory & d ) [inline]
```

#### 9.1.4.41 operator<<() [33/56]

```
std::ostream& gdcmm::operator<< (
    std::ostream & os,
    const File & val ) [inline]
```

#### 9.1.4.42 operator<<() [34/56]

```
std::ostream& gdcmm::operator<< (
    std::ostream & os,
    const FileMetaInformation & val ) [inline]
```

#### 9.1.4.43 operator<<() [35/56]

```
std::ostream& gdcmm::operator<< (
    std::ostream & os,
    const FileSet & f ) [inline]
```

**9.1.4.44 operator<<()** [36/56]

```
std::ostream& gdcM::operator<< (
    std::ostream & os,
    const Fragment & val ) [inline]
```

**9.1.4.45 operator<<()** [37/56]

```
std::ostream& gdcM::operator<< (
    std::ostream & os,
    const Global & g ) [inline]
```

**9.1.4.46 operator<<()** [38/56]

```
std::ostream& gdcM::operator<< (
    std::ostream & os,
    const Item & val ) [inline]
```

**9.1.4.47 operator<<()** [39/56]

```
std::ostream& gdcM::operator<< (
    std::ostream & os,
    const MrProtocol & d ) [inline]
```

**9.1.4.48 operator<<()** [40/56]

```
std::ostream& gdcM::operator<< (
    std::ostream & os,
    const Object & obj ) [inline]
```

**9.1.4.49 operator<<()** [41/56]

```
std::ostream& gdcM::operator<< (
    std::ostream & os,
    const Orientation & o ) [inline]
```

#### 9.1.4.50 operator<<() [42/56]

```
std::ostream& gdcM::operator<< (
    std::ostream & os,
    const PDBElement & val ) [inline]
```

#### 9.1.4.51 operator<<() [43/56]

```
std::ostream& gdcM::operator<< (
    std::ostream & os,
    const PDBHeader & d ) [inline]
```

#### 9.1.4.52 operator<<() [44/56]

```
std::ostream& gdcM::operator<< (
    std::ostream & os,
    const PhotometricInterpretation & val ) [inline]
```

#### 9.1.4.53 operator<<() [45/56]

```
std::ostream& gdcM::operator<< (
    std::ostream & os,
    const PixelFormat & pf ) [inline]
```

#### 9.1.4.54 operator<<() [46/56]

```
std::ostream& gdcM::operator<< (
    std::ostream & os,
    const Preamble & val ) [inline]
```

#### 9.1.4.55 operator<<() [47/56]

```
std::ostream& gdcM::operator<< (
    std::ostream & os,
    const PrivateDict & val ) [inline]
```

**9.1.4.56 operator<<() [48/56]**

```
std::ostream& gdcM::operator<< (
    std::ostream & os,
    const PrivateTag & val ) [inline]
```

**9.1.4.57 operator<<() [49/56]**

```
std::ostream& gdcM::operator<< (
    std::ostream & os,
    const Region & r ) [inline]
```

References gdcM::Region::Print().

**9.1.4.58 operator<<() [50/56]**

```
std::ostream& gdcM::operator<< (
    std::ostream & os,
    const Scanner & s ) [inline]
```

**9.1.4.59 operator<<() [51/56]**

```
std::ostream& gdcM::operator<< (
    std::ostream & os,
    const Sorter & s ) [inline]
```

**9.1.4.60 operator<<() [52/56]**

```
std::ostream& gdcM::operator<< (
    std::ostream & os,
    const StrictScanner & s ) [inline]
```

#### 9.1.4.61 operator<<() [53/56]

```
std::ostream& gdcM::operator<< (
    std::ostream & os,
    const SwapCode & sc ) [inline]
```

#### 9.1.4.62 operator<<() [54/56]

```
std::ostream& gdcM::operator<< (
    std::ostream & os,
    const Version & v ) [inline]
```

#### 9.1.4.63 operator<<() [55/56]

```
std::ostream& gdcM::operator<< (
    std::ostream & os,
    const VL & val ) [inline]
```

#### 9.1.4.64 operator<<() [56/56]

```
std::ostream& gdcM::operator<< (
    std::ostream & os,
    Event & e ) [inline]
```

Generic inserter operator for [Event](#) and its subclasses.

References [gdcM::Event::Print\(\)](#).

#### 9.1.4.65 operator==( )

```
bool gdcM::operator==(
    const CodeString & ref,
    const CodeString & cs ) [inline]
```

#### Examples

[DumpPhilipsECHO.cxx](#).

**9.1.4.66 operator>>()** [1/3]

```
std::istream& gdcm::operator>> (
    std::istream & _is,
    Tag & _val ) [inline]
```

**9.1.4.67 operator>>()** [2/3]

```
std::istream& gdcm::operator>> (
    std::istream & in,
    ignore_char const & ic ) [inline]
```

References gdcm::ignore\_char::m\_char.

**9.1.4.68 operator>>()** [3/3]

```
template<char TDelimiter, unsigned int TMaxLength, char TPadChar>
std::istream& gdcm::operator>> (
    std::istream & is,
    String< TDelimiter, TMaxLength, TPadChar > & ms ) [inline]
```

**9.1.4.69 Round()**

```
template<typename T >
static int gdcm::Round (
    T x ) [inline], [static]
```

Referenced by gdcm::ImageChangePhotometricInterpretation::RGB2YBR(), and gdcm::ImageChangePhotometricInterpretation::YBR2RGB().

**9.1.4.70 roundat()**

```
static int gdcm::roundat (
    char * buf,
    unsigned int i,
    int iexp ) [static]
```

References doround().

Referenced by x16printf().

### 9.1.4.71 TYPETOENCODING()

```
gdcM::TYPETOENCODING (
    SQ ,
    VRBINARy ,
    unsigned char )
```

### 9.1.4.72 x16printf()

```
template<typename Float >
static void gdcM::x16printf (
    char * buf,
    int size,
    Float f ) [static]
```

References `clean()`, and `roundat()`.

Referenced by `gdcM::EncodingImplementation< VR::VRASCII >::Write()`.

## 9.1.5 Variable Documentation

### 9.1.5.1 GlobalInstance

```
Global gdcM::GlobalInstance [static]
```

### 9.1.5.2 VRBINARy

```
gdcM::VRBINARy
```

Referenced by `gdcM::Element< TVR, VM::VM1_n >::Set()`, and `gdcM::Element< TVR, VM::VM1_n >::SetNoSwap()`.



## 9.2 gdcmm::network Namespace Reference

### Classes

- class [AAbortPDU](#)  
*AAbortPDU.*
- class [AAssociateACPDU](#)  
*AAssociateACPDU.*
- class [AAssociateRJPDU](#)  
*AAssociateRJPDU.*
- class [AAssociateRQPDU](#)  
*AAssociateRQPDU.*
- class [AbstractSyntax](#)  
*AbstractSyntax.*
- class [ApplicationContext](#)  
*ApplicationContext.*
- class [AReleaseRPPDU](#)  
*AReleaseRPPDU.*
- class [AReleaseRQPDU](#)  
*AReleaseRQPDU.*
- class [ARTIMTimer](#)  
*ARTIMTimer.*
- class [AsynchronousOperationsWindowSub](#)  
*AsynchronousOperationsWindowSub.*
- class [BaseCompositeMessage](#)  
*BaseCompositeMessage.*
- class [BaseNormalizedMessage](#)  
*BaseNormalizedMessage.*
- class [BasePDU](#)  
*BasePDU.*
- class [CEchoRQ](#)  
*CEchoRQ.*
- class [CEchoRSP](#)  
*CEchoRSP this file defines the messages for the cecho action.*
- class [CFind](#)
- class [CFindCancelRQ](#)  
*CFindCancelRQ this file defines the messages for the cfind action.*
- class [CFindRQ](#)  
*CFindRQ.*
- class [CFindRSP](#)  
*CFindRSP this file defines the messages for the cfind action.*
- class [CMoveCancelRq](#)
- class [CMoveRQ](#)  
*CMoveRQ.*
- class [CMoveRSP](#)  
*CMoveRSP this file defines the messages for the cmove action.*
- class [CompositeMessageFactory](#)

- *CompositeMessageFactory.*
- class CStoreRQ
  - *CStoreRQ.*
- class CStoreRSP
  - *CStoreRSP this file defines the messages for the cecho action.*
- class DIMSE
  - *DIMSE.*
- class ImplementationClassUIDSub
  - *ImplementationClassUIDSub.*
- class ImplementationUIDSub
  - *ImplementationUIDSub.*
- class ImplementationVersionNameSub
  - *ImplementationVersionNameSub.*
- class MaximumLengthSub
  - *MaximumLengthSub.*
- class NActionRQ
  - *NActionRQ.*
- class NActionRSP
  - *NActionRSP this file defines the messages for the NAction action.*
- class NCreateRQ
  - *NCreateRQ.*
- class NCreateRSP
  - *NCreateRSP this file defines the messages for the ncreate action.*
- class NDeleteRQ
  - *NDeleteRQ.*
- class NDeleteRSP
  - *NDeleteRSP this file defines the messages for the ndelete action.*
- class NEventReportRQ
  - *NEventReportRQ.*
- class NEventReportRSP
  - *NEventReportRSP this file defines the messages for the neventreport action.*
- class NGetRQ
  - *NGetRQ.*
- class NGetRSP
  - *NGetRSP this file defines the messages for the nget action.*
- class NormalizedMessageFactory
- class NSetRQ
  - *NSetRQ.*
- class NSetRSP
  - *NSetRSP this file defines the messages for the nset action.*
- class PDataTFPDU
  - *PDataTFPDU.*
- class PDUFactory
  - *PDUFactory basically, given an initial byte, construct the.*
- class PresentationContextAC
  - *PresentationContextAC.*
- class PresentationContextRQ

- PresentationContextRQ.*
- class [PresentationDataValue](#)
  - PresentationDataValue.*
- class [RoleSelectionSub](#)
  - RoleSelectionSub.*
- class [ServiceClassApplicationInformation](#)
- class [SOPClassExtendedNegociationSub](#)
  - SOPClassExtendedNegociationSub.*
- class [TableRow](#)
- class [TransferSyntaxSub](#)
  - TransferSyntaxSub.*
- struct [Transition](#)
- class [ULAction](#)
  - ULAction.*
- class [ULActionAA1](#)
- class [ULActionAA2](#)
- class [ULActionAA3](#)
- class [ULActionAA4](#)
- class [ULActionAA5](#)
- class [ULActionAA6](#)
- class [ULActionAA7](#)
- class [ULActionAA8](#)
- class [ULActionAE1](#)
- class [ULActionAE2](#)
- class [ULActionAE3](#)
- class [ULActionAE4](#)
- class [ULActionAE5](#)
- class [ULActionAE6](#)
- class [ULActionAE7](#)
- class [ULActionAE8](#)
- class [ULActionAR1](#)
- class [ULActionAR10](#)
- class [ULActionAR2](#)
- class [ULActionAR3](#)
- class [ULActionAR4](#)
- class [ULActionAR5](#)
- class [ULActionAR6](#)
- class [ULActionAR7](#)
- class [ULActionAR8](#)
- class [ULActionAR9](#)
- class [ULActionDT1](#)
- class [ULActionDT2](#)
- class [ULBasicCallback](#)
  - ULBasicCallback.*
- class [ULConnection](#)
  - ULConnection.*
- class [ULConnectionCallback](#)
- class [ULConnectionInfo](#)
  - ULConnectionInfo.*

- class [ULConnectionManager](#)  
*ULConnectionManager.*
- class [ULEvent](#)  
*ULEvent.*
- class [ULTransitionTable](#)  
*ULTransitionTable* The transition table of all the ULEvents, new ULActions, and ULStates.
- class [ULWritingCallback](#)
- class [UserInformation](#)  
*UserInformation.*

## Enumerations

- enum [EEventID](#) {  
[eAASSOCIATERequestLocalUser](#) = 0 ,  
[eTransportConnConfirmLocal](#) ,  
[eASSOCIATE\\_ACPDUreceived](#) ,  
[eASSOCIATE\\_RJPDUreceived](#) ,  
[eTransportConnIndicLocal](#) ,  
[eAASSOCIATE\\_RQPDUreceived](#) ,  
[eAASSOCIATEResponseAccept](#) ,  
[eAASSOCIATEResponseReject](#) ,  
[ePDATArequest](#) ,  
[ePDATATFPDU](#) ,  
[eARELEASERequest](#) ,  
[eARELEASE\\_RQPDUReceivedOpen](#) ,  
[eARELEASE\\_RPPDUReceived](#) ,  
[eARELEASEResponse](#) ,  
[eAABORTRequest](#) ,  
[eAABORTPDUReceivedOpen](#) ,  
[eTransportConnectionClosed](#) ,  
[eARTIMTimerExpired](#) ,  
[eUnrecognizedPDUReceived](#) ,  
[eEventDoesNotExist](#) }
- enum [EStateID](#) {  
[eStaDoesNotExist](#) = 0 ,  
[eSta1Idle](#) = 1 ,  
[eSta2Open](#) = 2 ,  
[eSta3WaitLocalAssoc](#) = 4 ,  
[eSta4LocalAssocDone](#) = 8 ,  
[eSta5WaitRemoteAssoc](#) = 16 ,  
[eSta6TransferReady](#) = 32 ,  
[eSta7WaitRelease](#) = 64 ,  
[eSta8WaitLocalRelease](#) = 128 ,  
[eSta9ReleaseCollisionRqLocal](#) = 256 ,  
[eSta10ReleaseCollisionAc](#) = 512 ,  
[eSta11ReleaseCollisionRq](#) = 1024 ,  
[eSta12ReleaseCollisionAcLocal](#) = 2048 ,  
[eSta13AwaitingClose](#) = 4096 }

## Functions

- int [GetStateIndex](#) ([EStateID](#) inState)

## Variables

- const int `cMaxEventID` = `eEventDoesNotExist`
- const int `cMaxStateID` = 13

## 9.2.1 Enumeration Type Documentation

### 9.2.1.1 EEventID

enum `gdcmm::network::EEventID`

#### Enumerator

<code>eAASSOCIATERequestLocalUser</code>	
<code>eTransportConnConfirmLocal</code>	
<code>eASSOCIATE_ACPDUreceived</code>	
<code>eASSOCIATE_RJPDUreceived</code>	
<code>eTransportConnIndicLocal</code>	
<code>eAASSOCIATE_RQPDUreceived</code>	
<code>eAASSOCIATEResponseAccept</code>	
<code>eAASSOCIATEResponseReject</code>	
<code>ePDATArequest</code>	
<code>ePDATATFPDU</code>	
<code>eARELEASERequest</code>	
<code>eARELEASE_RQPDUreceivedOpen</code>	
<code>eARELEASE_RPPDUreceived</code>	
<code>eARELEASEResponse</code>	
<code>eAABORTRequest</code>	
<code>eAABORTPDUreceivedOpen</code>	
<code>eTransportConnectionClosed</code>	
<code>eARTIMTimerExpired</code>	
<code>eUnrecognizedPDUreceived</code>	
<code>eEventDoesNotExist</code>	

### 9.2.1.2 EStateID

enum `gdcmm::network::EStateID`

Each network connection will be in a particular state at any given time. Those states have IDs as described in the standard ps3.8-2009, roughly 1-13. This enumeration lists those states. The actual ULState class will contain more information about transitions to other states.

name and date: 16 sept 2010 mmr

## Enumerator

eStaDoesNotExist	
eSta1Idle	
eSta2Open	
eSta3WaitLocalAssoc	
eSta4LocalAssocDone	
eSta5WaitRemoteAssoc	
eSta6TransferReady	
eSta7WaitRelease	
eSta8WaitLocalRelease	
eSta9ReleaseCollisionRqLocal	
eSta10ReleaseCollisionAc	
eSta11ReleaseCollisionRq	
eSta12ReleaseCollisionAcLocal	
eSta13AwaitingClose	

## 9.2.2 Function Documentation

### 9.2.2.1 GetStateIndex()

```
int gdcn::network::GetStateIndex (
    EStateID inState ) [inline]
```

References eSta10ReleaseCollisionAc, eSta11ReleaseCollisionRq, eSta12ReleaseCollisionAcLocal, eSta13AwaitingClose, eSta1Idle, eSta2Open, eSta3WaitLocalAssoc, eSta4LocalAssocDone, eSta5WaitRemoteAssoc, eSta6TransferReady, eSta7WaitRelease, eSta8WaitLocalRelease, eSta9ReleaseCollisionRqLocal, and eStaDoesNotExist.

## 9.2.3 Variable Documentation

### 9.2.3.1 cMaxEventID

```
const int gdcn::network::cMaxEventID = eEventDoesNotExist
```

### 9.2.3.2 cMaxStateID

```
const int gdcmm::network::cMaxStateID = 13
```

Referenced by `gdcmm::network::TableRow::TableRow()`, and `gdcmm::network::TableRow::~~TableRow()`.

## 9.3 gdcmm::SegmentHelper Namespace Reference

### Classes

- struct [BasicCodedEntry](#)

*This structure defines a basic coded entry with all of its attributes.*

## 9.4 gdcmm::terminal Namespace Reference

Class for Terminal.

### Enumerations

- enum [Attribute](#) {  
  [reset](#) = 0 ,  
  [bright](#) = 1 ,  
  [dim](#) = 2 ,  
  [underline](#) = 3 ,  
  [blink](#) = 5 ,  
  [reverse](#) = 7 ,  
  [hidden](#) = 8 }
- enum [Color](#) {  
  [black](#) = 0 ,  
  [red](#) ,  
  [green](#) ,  
  [yellow](#) ,  
  [blue](#) ,  
  [magenta](#) ,  
  [cyan](#) ,  
  [white](#) }
- enum [Mode](#) {  
  [CONSOLE](#) = 0 ,  
  [VT100](#) }

### Functions

- `GDCM_EXPORT` `std::string setattribute` ([Attribute](#) att)
- `GDCM_EXPORT` `std::string setbgcolor` ([Color](#) c)
- `GDCM_EXPORT` `std::string setfgcolor` ([Color](#) c)
- `GDCM_EXPORT` `void setmode` ([Mode](#) m)



### 9.4.1 Detailed Description

Class for Terminal.

Allow one to print in color in a shell

- support VT100 compatible shell
- win32 console

### 9.4.2 Enumeration Type Documentation

#### 9.4.2.1 Attribute

```
enum gdcmm::terminal::Attribute
```

Enumerator

reset	
bright	
dim	
underline	
blink	
reverse	
hidden	

#### 9.4.2.2 Color

```
enum gdcmm::terminal::Color
```

Enumerator

black	
red	
green	
yellow	
blue	
magenta	
cyan	
white	

### 9.4.2.3 Mode

```
enum gdcM::terminal::Mode
```

Enumerator

CONSOLE	
VT100	

## 9.4.3 Function Documentation

### 9.4.3.1 setattribute()

```
GDCM_EXPORT std::string gdcM::terminal::setattribute (  
    Attribute att )
```

### 9.4.3.2 setbgcolor()

```
GDCM_EXPORT std::string gdcM::terminal::setbgcolor (  
    Color c )
```

### 9.4.3.3 setfgcolor()

```
GDCM_EXPORT std::string gdcM::terminal::setfgcolor (  
    Color c )
```

### 9.4.3.4 setmode()

```
GDCM_EXPORT void gdcM::terminal::setmode (  
    Mode m )
```

## Chapter 10

# Class Documentation

### 10.1 gdcM::network::AAbortPDU Class Reference

[AAbortPDU](#).

```
#include <gdcMAAbortPDU.h>
```

Inheritance diagram for gdcM::network::AAbortPDU:

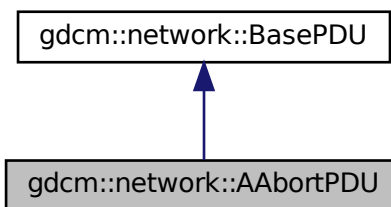

Collaboration diagram for gdcM::network::AAbortPDU:

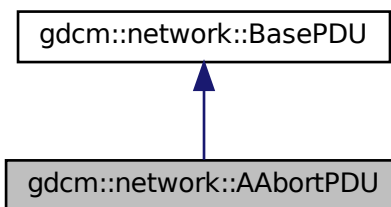

## Public Member Functions

- [AAbortPDU](#) ()
- bool [IsLastFragment](#) () const override
- void [Print](#) (std::ostream &os) const override
- std::istream & [Read](#) (std::istream &is) override
- void [SetReason](#) (const uint8\_t r)
- void [SetSource](#) (const uint8\_t s)
- size\_t [Size](#) () const override
- const std::ostream & [Write](#) (std::ostream &os) const override

### 10.1.1 Detailed Description

[AAbortPDU](#).

[Table 9-26](#) A-ABORT PDU FIELDS

### 10.1.2 Constructor & Destructor Documentation

#### 10.1.2.1 AAbortPDU()

```
gdcmm::network::AAbortPDU::AAbortPDU ( )
```

### 10.1.3 Member Function Documentation

#### 10.1.3.1 IsLastFragment()

```
bool gdcmm::network::AAbortPDU::IsLastFragment ( ) const [inline], [override], [virtual]
```

Implements [gdcmm::network::BasePDU](#).

#### 10.1.3.2 Print()

```
void gdcmm::network::AAbortPDU::Print (
    std::ostream & os ) const [override], [virtual]
```

Implements [gdcmm::network::BasePDU](#).

### 10.1.3.3 Read()

```
std::istream& gdcmm::network::AAbortPDU::Read (
    std::istream & is ) [override], [virtual]
```

Implements [gdcmm::network::BasePDU](#).

### 10.1.3.4 SetReason()

```
void gdcmm::network::AAbortPDU::SetReason (
    const uint8_t r )
```

### 10.1.3.5 SetSource()

```
void gdcmm::network::AAbortPDU::SetSource (
    const uint8_t s )
```

### 10.1.3.6 Size()

```
size_t gdcmm::network::AAbortPDU::Size ( ) const [override], [virtual]
```

Implements [gdcmm::network::BasePDU](#).

### 10.1.3.7 Write()

```
const std::ostream& gdcmm::network::AAbortPDU::Write (
    std::ostream & os ) const [override], [virtual]
```

Implements [gdcmm::network::BasePDU](#).

The documentation for this class was generated from the following file:

- [gdcmmAAbortPDU.h](#)

## 10.2 gdcM::network::AAssociateACPDU Class Reference

[AAssociateACPDU](#).

```
#include <gdcMAAssociateACPDU.h>
```

Inheritance diagram for gdcM::network::AAssociateACPDU:

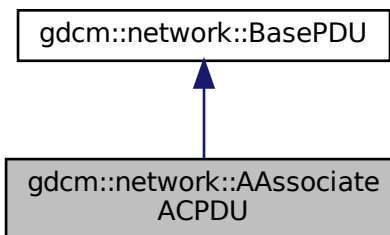

Collaboration diagram for gdcM::network::AAssociateACPDU:

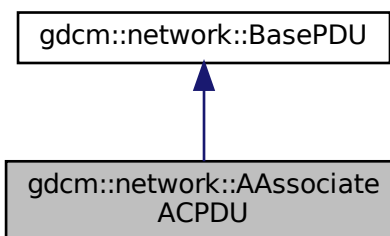

### Public Types

- typedef std::vector< [PresentationContextAC](#) >::size\_type [SizeType](#)

## Public Member Functions

- [AAssociateACPDU](#) ()
- void [AddPresentationContextAC](#) ([PresentationContextAC](#) const &pcac)
- [SizeType](#) [GetNumberOfPresentationContextAC](#) () const
- const [PresentationContextAC](#) & [GetPresentationContextAC](#) ([SizeType](#) i)
- const [UserInformation](#) & [GetUserInformation](#) () const
- void [InitFromRQ](#) ([AAssociateRQPDU](#) const &rqpdu)
- bool [IsLastFragment](#) () const override
- void [Print](#) (std::ostream &os) const override
- std::istream & [Read](#) (std::istream &is) override
- [SizeType](#) [Size](#) () const override
- const std::ostream & [Write](#) (std::ostream &os) const override

## Protected Member Functions

- void [SetCalledAETitle](#) (const char calledaetitle[16])
- void [SetCallingAETitle](#) (const char callingaetitle[16])

## Friends

- class [AAssociateRQPDU](#)

### 10.2.1 Detailed Description

[AAssociateACPDU](#).

[Table 9-17](#) ASSOCIATE-AC PDU fields

### 10.2.2 Member Typedef Documentation

#### 10.2.2.1 SizeType

```
typedef std::vector<PresentationContextAC>::size_type gdcmm::network::AAssociateACPDU::SizeType
```

### 10.2.3 Constructor & Destructor Documentation

### 10.2.3.1 AAssociateACPDU()

```
gdcM::network::AAssociateACPDU::AAssociateACPDU ( )
```

## 10.2.4 Member Function Documentation

### 10.2.4.1 AddPresentationContextAC()

```
void gdcM::network::AAssociateACPDU::AddPresentationContextAC (
    PresentationContextAC const & pcac )
```

### 10.2.4.2 GetNumberOfPresentationContextAC()

```
SizeType gdcM::network::AAssociateACPDU::GetNumberOfPresentationContextAC ( ) const [inline]
```

### 10.2.4.3 GetPresentationContextAC()

```
const PresentationContextAC& gdcM::network::AAssociateACPDU::GetPresentationContextAC (
    SizeType i ) [inline]
```

### 10.2.4.4 GetUserInformation()

```
const UserInformation& gdcM::network::AAssociateACPDU::GetUserInformation ( ) const [inline]
```

### 10.2.4.5 InitFromRQ()

```
void gdcM::network::AAssociateACPDU::InitFromRQ (
    AAssociateRQPDU const & rqpdu )
```



#### 10.2.4.6 IsLastFragment()

```
bool gdcn::network::AAssociateACPDU::IsLastFragment ( ) const [inline], [override], [virtual]
```

Implements [gdcn::network::BasePDU](#).

#### 10.2.4.7 Print()

```
void gdcn::network::AAssociateACPDU::Print (
    std::ostream & os ) const [override], [virtual]
```

Implements [gdcn::network::BasePDU](#).

#### 10.2.4.8 Read()

```
std::istream& gdcn::network::AAssociateACPDU::Read (
    std::istream & is ) [override], [virtual]
```

Implements [gdcn::network::BasePDU](#).

#### 10.2.4.9 SetCalledAETitle()

```
void gdcn::network::AAssociateACPDU::SetCalledAETitle (
    const char calledaetitle[16] ) [protected]
```

#### 10.2.4.10 SetCallingAETitle()

```
void gdcn::network::AAssociateACPDU::SetCallingAETitle (
    const char callingaetitle[16] ) [protected]
```

#### 10.2.4.11 Size()

```
SizeType gdcn::network::AAssociateACPDU::Size ( ) const [override], [virtual]
```

Implements [gdcn::network::BasePDU](#).

### 10.2.4.12 Write()

```
const std::ostream& gdcM::network::AAssociateACPDU::Write (
    std::ostream & os ) const [override], [virtual]
```

Implements [gdcM::network::BasePDU](#).

## 10.2.5 Friends And Related Function Documentation

### 10.2.5.1 AAssociateRQPDU

```
friend class AAssociateRQPDU [friend]
```

The documentation for this class was generated from the following file:

- [gdcMAAssociateACPDU.h](#)

## 10.3 gdcM::network::AAssociateRJPDU Class Reference

[AAssociateRJPDU](#).

```
#include <gdcMAAssociateRJPDU.h>
```

Inheritance diagram for gdcM::network::AAssociateRJPDU:

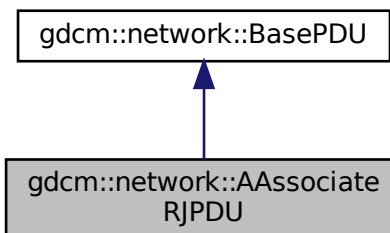

Collaboration diagram for gdcM::network::AAssociateRJPDU:

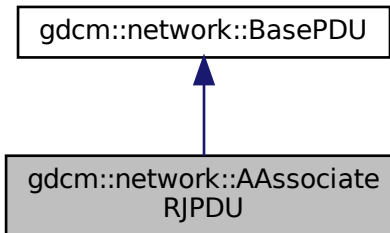

## Public Member Functions

- [AAssociateRJPDU](#) ()
- bool [IsLastFragment](#) () const override
- void [Print](#) (std::ostream &os) const override
- std::istream & [Read](#) (std::istream &is) override
- size\_t [Size](#) () const override
- const std::ostream & [Write](#) (std::ostream &os) const override

### 10.3.1 Detailed Description

[AAssociateRJPDU](#).

[Table 9-21 ASSOCIATE-RJ PDU FIELDS](#)

### 10.3.2 Constructor & Destructor Documentation

#### 10.3.2.1 AAssociateRJPDU()

```
gdcM::network::AAssociateRJPDU::AAssociateRJPDU ( )
```

### 10.3.3 Member Function Documentation

### 10.3.3.1 IsLastFragment()

```
bool gdcn::network::AAssociateRJPDU::IsLastFragment ( ) const [inline], [override], [virtual]
```

Implements [gdcn::network::BasePDU](#).

### 10.3.3.2 Print()

```
void gdcn::network::AAssociateRJPDU::Print (
    std::ostream & os ) const [override], [virtual]
```

Implements [gdcn::network::BasePDU](#).

### 10.3.3.3 Read()

```
std::istream& gdcn::network::AAssociateRJPDU::Read (
    std::istream & is ) [override], [virtual]
```

Implements [gdcn::network::BasePDU](#).

### 10.3.3.4 Size()

```
size_t gdcn::network::AAssociateRJPDU::Size ( ) const [override], [virtual]
```

Implements [gdcn::network::BasePDU](#).

### 10.3.3.5 Write()

```
const std::ostream& gdcn::network::AAssociateRJPDU::Write (
    std::ostream & os ) const [override], [virtual]
```

Implements [gdcn::network::BasePDU](#).

The documentation for this class was generated from the following file:

- [gdcnAAssociateRJPDU.h](#)

## 10.4 gdcmm::network::AAssociateRQPDU Class Reference

[AAssociateRQPDU](#).

```
#include <gdcmmAAssociateRQPDU.h>
```

Inheritance diagram for gdcmm::network::AAssociateRQPDU:

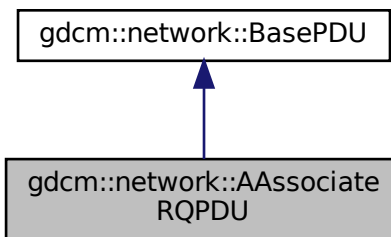

Collaboration diagram for gdcmm::network::AAssociateRQPDU:

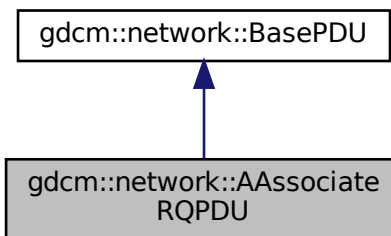

### Public Types

- typedef std::vector< [PresentationContextRQ](#) > [PresentationContextArrayType](#)
- typedef std::vector< [PresentationContextRQ](#) >::size\_type [SizeType](#)

## Public Member Functions

- [AAssociateRQPDU](#) ()
- [AAssociateRQPDU](#) (const [AAssociateRQPDU](#) &pdu)
- void [AddPresentationContext](#) ([PresentationContextRQ](#) const &pc)
- std::string [GetCalledAETitle](#) () const
- std::string [GetCallingAETitle](#) () const
- [SizeType](#) [GetNumberOfPresentationContext](#) () const
- [PresentationContextRQ](#) const & [GetPresentationContext](#) ([SizeType](#) i) const
- const [PresentationContextRQ](#) \* [GetPresentationContextByAbstractSyntax](#) ([AbstractSyntax](#) const &absyn) const
- const [PresentationContextRQ](#) \* [GetPresentationContextByID](#) (uint8\_t i) const
- [PresentationContextArrayType](#) const & [GetPresentationContexts](#) ()
- const [UserInfoInformation](#) & [GetUserInfoInformation](#) () const
- bool [IsLastFragment](#) () const override
- void [Print](#) (std::ostream &os) const override
- std::istream & [Read](#) (std::istream &is) override
- void [SetCalledAETitle](#) (const char calledaetitle[16])  
*Set the Called AE Title.*
- void [SetCallingAETitle](#) (const char callingaetitle[16])  
*Set the Calling AE Title.*
- void [SetUserInfoInformation](#) ([UserInfoInformation](#) const &ui)
- size\_t [Size](#) () const override
- const std::ostream & [Write](#) (std::ostream &os) const override

## Static Public Member Functions

- static bool [IsAETitleValid](#) (const char title[16])  
*Check whether or not the.*

## Protected Member Functions

- std::string [GetReserved43\\_74](#) () const

## Friends

- class [AAssociateACPDU](#)

### 10.4.1 Detailed Description

[AAssociateRQPDU](#).

[Table 9-11](#) ASSOCIATE-RQ PDU fields

### 10.4.2 Member Typedef Documentation

### 10.4.2.1 PresentationContextArrayType

```
typedef std::vector<PresentationContextRQ> gdcmm::network::AAssociateRQPDU::PresentationContextArrayType
```

### 10.4.2.2 SizeType

```
typedef std::vector<PresentationContextRQ>::size_type gdcmm::network::AAssociateRQPDU::SizeType
```

## 10.4.3 Constructor & Destructor Documentation

### 10.4.3.1 AAssociateRQPDU() [1/2]

```
gdcmm::network::AAssociateRQPDU::AAssociateRQPDU ( )
```

### 10.4.3.2 AAssociateRQPDU() [2/2]

```
gdcmm::network::AAssociateRQPDU::AAssociateRQPDU (
    const AAssociateRQPDU & pdu ) [inline]
```

## 10.4.4 Member Function Documentation

### 10.4.4.1 AddPresentationContext()

```
void gdcmm::network::AAssociateRQPDU::AddPresentationContext (
    PresentationContextRQ const & pc )
```

### 10.4.4.2 GetCalledAETitle()

```
std::string gdcmm::network::AAssociateRQPDU::GetCalledAETitle ( ) const [inline]
```

#### 10.4.4.3 GetCallingAETitle()

```
std::string gdcn::network::AAssociateRQPDU::GetCallingAETitle ( ) const [inline]
```

#### 10.4.4.4 GetNumberOfPresentationContext()

```
SizeType gdcn::network::AAssociateRQPDU::GetNumberOfPresentationContext ( ) const [inline]
```

#### 10.4.4.5 GetPresentationContext()

```
PresentationContextRQ const& gdcn::network::AAssociateRQPDU::GetPresentationContext (
    SizeType i ) const [inline]
```

#### 10.4.4.6 GetPresentationContextByAbstractSyntax()

```
const PresentationContextRQ* gdcn::network::AAssociateRQPDU::GetPresentationContextByAbstract←
Syntax (
    AbstractSyntax const & absyn ) const
```

#### 10.4.4.7 GetPresentationContextByID()

```
const PresentationContextRQ* gdcn::network::AAssociateRQPDU::GetPresentationContextByID (
    uint8_t i ) const
```

#### 10.4.4.8 GetPresentationContexts()

```
PresentationContextArrayType const& gdcn::network::AAssociateRQPDU::GetPresentationContexts ( )
[inline]
```



#### 10.4.4.9 GetReserved43\_74()

```
std::string gdcmm::network::AAssociateRQPDU::GetReserved43_74 ( ) const [protected]
```

#### 10.4.4.10 GetUserInfoation()

```
const UserInfoation& gdcmm::network::AAssociateRQPDU::GetUserInfoation ( ) const [inline]
```

#### 10.4.4.11 IsAETitleValid()

```
static bool gdcmm::network::AAssociateRQPDU::IsAETitleValid (
    const char title[16] ) [static]
```

Check whether or not the.

##### Parameters

<i>title</i>	is a valid AE title
--------------	---------------------

#### 10.4.4.12 IsLastFragment()

```
bool gdcmm::network::AAssociateRQPDU::IsLastFragment ( ) const [inline], [override], [virtual]
```

Implements [gdcmm::network::BasePDU](#).

#### 10.4.4.13 Print()

```
void gdcmm::network::AAssociateRQPDU::Print (
    std::ostream & os ) const [override], [virtual]
```

This function will initialize an [AAssociateACPDU](#) from the fields in the [AAssociateRQPDU](#) structure

Implements [gdcmm::network::BasePDU](#).

#### 10.4.4.14 Read()

```
std::istream& gdcn::network::AAssociateRQPDU::Read (
    std::istream & is ) [override], [virtual]
```

Implements [gdcn::network::BasePDU](#).

#### 10.4.4.15 SetCalledAETitle()

```
void gdcn::network::AAssociateRQPDU::SetCalledAETitle (
    const char calledaetitle[16] )
```

Set the Called AE Title.

#### 10.4.4.16 SetCallingAETitle()

```
void gdcn::network::AAssociateRQPDU::SetCallingAETitle (
    const char callingaetitle[16] )
```

Set the Calling AE Title.

#### 10.4.4.17 SetUserInformation()

```
void gdcn::network::AAssociateRQPDU::SetUserInformation (
    UserInformation const & ui )
```

#### 10.4.4.18 Size()

```
size_t gdcn::network::AAssociateRQPDU::Size ( ) const [override], [virtual]
```

Implements [gdcn::network::BasePDU](#).

#### 10.4.4.19 Write()

```
const std::ostream& gdcM::network::AAssociateRQPDU::Write (
    std::ostream & os ) const [override], [virtual]
```

Implements [gdcM::network::BasePDU](#).

### 10.4.5 Friends And Related Function Documentation

#### 10.4.5.1 AAssociateACPDU

```
friend class AAssociateACPDU [friend]
```

The documentation for this class was generated from the following file:

- [gdcMAAssociateRQPDU.h](#)

## 10.5 gdcM::AbortEvent Class Reference

```
#include <gdcMEvent.h>
```

Inheritance diagram for gdcM::AbortEvent:

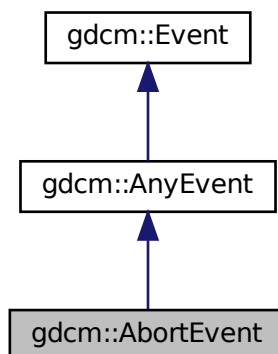

Collaboration diagram for `gdcm::AbortEvent`:

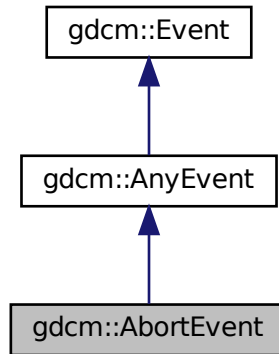

### Additional Inherited Members

The documentation for this class was generated from the following file:

- [gdcmEvent.h](#)

## 10.6 `gdcm::network::AbstractSyntax` Class Reference

[AbstractSyntax](#).

```
#include <gdcmAbstractSyntax.h>
```

### Public Member Functions

- [AbstractSyntax](#) ()
- [DataElement GetAsDataElement](#) () const
- const char \* [GetName](#) () const
- bool [operator==](#) (const [AbstractSyntax](#) &as) const
- void [Print](#) (std::ostream &os) const
- std::istream & [Read](#) (std::istream &is)
- void [SetName](#) (const char \*name)
- void [SetNameFromUID](#) ([UIDs::TSName](#) tsname)
- size\_t [Size](#) () const
- const std::ostream & [Write](#) (std::ostream &os) const

## 10.6.1 Detailed Description

[AbstractSyntax](#).

[Table 9-14](#) ABSTRACT SYNTAX SUB-ITEM FIELDS

## 10.6.2 Constructor & Destructor Documentation

### 10.6.2.1 AbstractSyntax()

```
gdcm::network::AbstractSyntax::AbstractSyntax ( )
```

## 10.6.3 Member Function Documentation

### 10.6.3.1 GetAsDataElement()

```
DataElement gdcm::network::AbstractSyntax::GetAsDataElement ( ) const
```

### 10.6.3.2 GetName()

```
const char* gdcm::network::AbstractSyntax::GetName ( ) const [inline]
```

### 10.6.3.3 operator==( )

```
bool gdcm::network::AbstractSyntax::operator== (
    const AbstractSyntax & as ) const [inline]
```

### 10.6.3.4 Print()

```
void gdcm::network::AbstractSyntax::Print (
    std::ostream & os ) const
```

### 10.6.3.5 Read()

```
std::istream& gdcM::network::AbstractSyntax::Read (
    std::istream & is )
```

### 10.6.3.6 SetName()

```
void gdcM::network::AbstractSyntax::SetName (
    const char * name ) [inline]
```

### 10.6.3.7 SetNameFromUID()

```
void gdcM::network::AbstractSyntax::SetNameFromUID (
    UIDs::TSName tsname )
```

### 10.6.3.8 Size()

```
size_t gdcM::network::AbstractSyntax::Size ( ) const
```

### 10.6.3.9 Write()

```
const std::ostream& gdcM::network::AbstractSyntax::Write (
    std::ostream & os ) const
```

The documentation for this class was generated from the following file:

- [gdcMAbstractSyntax.h](#)

## 10.7 gdcm::AnonymizeEvent Class Reference

[AnonymizeEvent](#).

```
#include <gdcmAnonymizeEvent.h>
```

Inheritance diagram for gdcm::AnonymizeEvent:

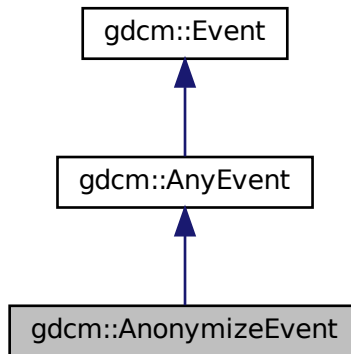

Collaboration diagram for gdcm::AnonymizeEvent:

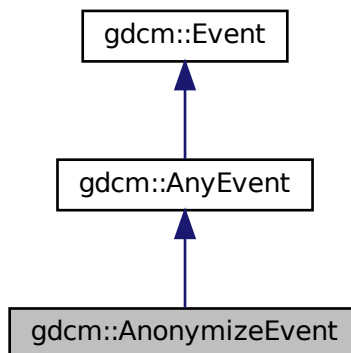

### Public Types

- typedef [AnonymizeEvent](#) Self
- typedef [AnyEvent](#) Superclass

## Public Member Functions

- [AnonymizeEvent](#) (const [Self](#) &s)
- [AnonymizeEvent](#) ([Tag](#) const &tag=0)
- [~AnonymizeEvent](#) () override=default
- bool [CheckEvent](#) (const [::gdcM::Event](#) \*e) const override
- const char \* [GetEventName](#) () const override
- [Tag](#) const & [GetTag](#) () const
- [::gdcM::Event](#) \* [MakeObject](#) () const override
- void [operator=](#) (const [Self](#) &)=delete
- void [SetTag](#) (const [Tag](#) &t)

### 10.7.1 Detailed Description

[AnonymizeEvent](#).

Special type of event triggered during the Anonymization process

See also

[Anonymizer](#)

### 10.7.2 Member Typedef Documentation

#### 10.7.2.1 Self

```
typedef AnonymizeEvent gdcM::AnonymizeEvent::Self
```

#### 10.7.2.2 Superclass

```
typedef AnyEvent gdcM::AnonymizeEvent::Superclass
```

### 10.7.3 Constructor & Destructor Documentation



### 10.7.3.1 AnonymizeEvent() [1/2]

```
gdcM::AnonymizeEvent::AnonymizeEvent (
    Tag const & tag = 0 ) [inline]
```

### 10.7.3.2 ~AnonymizeEvent()

```
gdcM::AnonymizeEvent::~~AnonymizeEvent ( ) [override], [default]
```

### 10.7.3.3 AnonymizeEvent() [2/2]

```
gdcM::AnonymizeEvent::AnonymizeEvent (
    const Self & s ) [inline]
```

## 10.7.4 Member Function Documentation

### 10.7.4.1 CheckEvent()

```
bool gdcM::AnonymizeEvent::CheckEvent (
    const ::gdcM::Event * e ) const [inline], [override]
```

### 10.7.4.2 GetEventName()

```
const char* gdcM::AnonymizeEvent::GetEventName ( ) const [inline], [override], [virtual]
```

Return the StringName associated with the event.

Implements [gdcM::Event](#).

### 10.7.4.3 GetTag()

```
Tag const& gdcM::AnonymizeEvent::GetTag ( ) const [inline]
```

#### 10.7.4.4 MakeObject()

```
::gdcM::Event* gdcM::AnonymizeEvent::MakeObject ( ) const [inline], [override], [virtual]
```

Create an [Event](#) of this type This method work as a Factory for creating events of each particular type.

Implements [gdcM::Event](#).

#### 10.7.4.5 operator=()

```
void gdcM::AnonymizeEvent::operator= (
    const Self & ) [delete]
```

#### 10.7.4.6 SetTag()

```
void gdcM::AnonymizeEvent::SetTag (
    const Tag & t ) [inline]
```

The documentation for this class was generated from the following file:

- [gdcMAnonymizeEvent.h](#)

## 10.8 gdcM::Anonymizer Class Reference

[Anonymizer](#).

```
#include <gdcMAnonymizer.h>
```

Inheritance diagram for gdcM::Anonymizer:

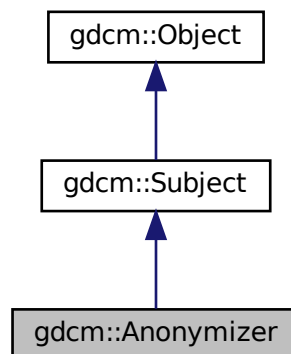

Collaboration diagram for gdcM::Anonymizer:

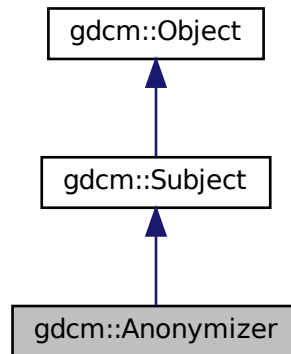

## Public Member Functions

- [Anonymizer](#) ()
- [~Anonymizer](#) () override
- bool [BasicApplicationLevelConfidentialityProfile](#) (bool deidentify=true)
- bool [Empty](#) (Tag const &t)
- const [CryptographicMessageSyntax](#) \* [GetCryptographicMessageSyntax](#) () const
- [File](#) & [GetFile](#) ()
- bool [Remove](#) (Tag const &t)
- bool [RemoveGroupLength](#) ()
  - *Main function that loop over all elements and remove group length.*
- bool [RemovePrivateTags](#) ()
  - *Main function that loop over all elements and remove private tags.*
- bool [RemoveRetired](#) ()
  - *Main function that loop over all elements and remove retired element.*
- bool [Replace](#) (Tag const &t, const char \*value)
- bool [Replace](#) (Tag const &t, const char \*value, VL const &vl)
- void [SetCryptographicMessageSyntax](#) ([CryptographicMessageSyntax](#) \*cms)
  - *Set/Get CMS key that will be used to encrypt the dataset within BasicApplicationLevelConfidentialityProfile.*
- void [SetFile](#) (const [File](#) &f)
  - *Set/Get File.*

## Static Public Member Functions

- static void [ClearInternalUIDs](#) ()
- static std::vector< [Tag](#) > [GetBasicApplicationLevelConfidentialityProfileAttributes](#) ()
  - *Return the list of Tag that will be considered when anonymizing a DICOM file.*
- static [SmartPointer](#)< [Anonymizer](#) > [New](#) ()
  - *for wrapped language: instantiate a reference counted object*

## Protected Member Functions

- bool `BALCPPProtect` (`DataSet` &ds, `Tag` const &tag, const `IOD` &iod)
- bool `CanEmptyTag` (`Tag` const &tag, const `IOD` &iod) const
- void `RecurseDataSet` (`DataSet` &ds)

### 10.8.1 Detailed Description

#### `Anonymizer`.

This class is a multi purpose anonymizer. It can work in 2 mode:

- Full (irreversible) anonymizer (aka dumb mode)
- reversible de-identifier/re-identifier (aka smart mode). This implements the Basic Application Level Confidentiality Profile, DICOM PS 3.15-2009

1. dumb mode This is a dumb anonymizer implementation. All it allows user is simple operation such as:

#### `Tag` based functions:

- complete removal of DICOM attribute (Remove)
- make a tag empty, ie make it's length 0 (Empty)
- replace with another string-based value (Replace)

#### `DataSet` based functions:

- Remove all group length attribute from a DICOM dataset (Group Length element are deprecated, DICOM 2008)
- Remove all private attributes
- Remove all retired attributes

All function calls actually execute the user specified request. Previous implementation were calling a general Anonymize function but traversing a `std::set` is  $O(n)$  operation, while a simple user specified request is  $O(\log(n))$  operation. So 'm' user interaction is  $O(m*\log(n))$  which is  $< O(n)$  complexity.

1. smart mode this mode implements the Basic Application Level Confidentiality Profile (DICOM PS 3.15-2008) In this case, it is extremely important to use the same `Anonymizer` class when anonymizing a `FileSet`. Once the `Anonymizer` is destroyed its memory of known (already processed) `UIDs` will be lost. which will make the anonymizer behaves incorrectly for attributes such as `Series UID` `Study UID` where user want some consistency. When attribute is `Type 1 / Type 1C`, a dummy generator will take in the existing value and produce a dummy value (a sha1 representation). sha1 algorithm is considered to be cryptographically strong (compared to md5sum) so that we meet the following two conditions:

- Produce the same dummy value for the same input value
- do not provide an easy way to retrieve the original value from the sha1 generated value

This class implement the Subject/Observer pattern trigger the following event:

- [AnonymizeEvent](#)
- [IterationEvent](#)
- [StartEvent](#)
- [EndEvent](#)

See also

[CryptographicMessageSyntax](#)

Examples

[ClinicalTrialAnnotate.cxx](#), [CreateJPIPDataSet.cxx](#), and [EncapsulateFileInRawData.cxx](#).

## 10.8.2 Constructor & Destructor Documentation

### 10.8.2.1 Anonymizer()

```
gdcm::Anonymizer::Anonymizer ( ) [inline]
```

### 10.8.2.2 ~Anonymizer()

```
gdcm::Anonymizer::~~Anonymizer ( ) [override]
```

## 10.8.3 Member Function Documentation

### 10.8.3.1 BALCPPProtect()

```
bool gdcm::Anonymizer::BALCPPProtect (
    DataSet & ds,
    Tag const & tag,
    const IOD & iod ) [protected]
```

### 10.8.3.2 BasicApplicationLevelConfidentialityProfile()

```
bool gdcM::Anonymizer::BasicApplicationLevelConfidentialityProfile (
    bool deidentify = true )
```

PS 3.15 / E.1.1 De-Identifier An Application may claim conformance to the Basic Application Level Confidentiality Profile as a deidentifier if it protects all Attributes that might be used by unauthorized entities to identify the patient. NOT THREAD SAFE

### 10.8.3.3 CanEmptyTag()

```
bool gdcM::Anonymizer::CanEmptyTag (
    Tag const & tag,
    const IOD & iod ) const [protected]
```

### 10.8.3.4 ClearInternalUIDs()

```
static void gdcM::Anonymizer::ClearInternalUIDs ( ) [static]
```

Clear the internal mapping of real [UIDs](#) to generated [UIDs](#)

#### Warning

the mapping is definitely lost

### 10.8.3.5 Empty()

```
bool gdcM::Anonymizer::Empty (
    Tag const & t )
```

Make [Tag](#) *t* empty (if not found tag will be created) Warning: does not handle SQ element

#### Examples

[CreateJPIPDataSet.cxx](#).

### 10.8.3.6 GetBasicApplicationLevelConfidentialityProfileAttributes()

```
static std::vector<Tag> gdcm::Anonymizer::GetBasicApplicationLevelConfidentialityProfileAttributes  
( ) [static]
```

Return the list of [Tag](#) that will be considered when anonymizing a DICOM file.

#### Examples

[GenFakeIdentifyFile.cxx](#), and [TraverseModules.cxx](#).

### 10.8.3.7 GetCryptographicMessageSyntax()

```
const CryptographicMessageSyntax* gdcm::Anonymizer::GetCryptographicMessageSyntax ( ) const
```

### 10.8.3.8 GetFile()

```
File& gdcm::Anonymizer::GetFile ( ) [inline]
```

### 10.8.3.9 New()

```
static SmartPointer<Anonymizer> gdcm::Anonymizer::New ( ) [inline], [static]
```

for wrapped language: instantiate a reference counted object

### 10.8.3.10 RecurseDataSet()

```
void gdcm::Anonymizer::RecurseDataSet (  
    DataSet & ds ) [protected]
```

### 10.8.3.11 Remove()

```
bool gdcm::Anonymizer::Remove (  
    Tag const & t )
```

remove a tag (even a SQ can be removed) Return code is false when tag t cannot be found

### 10.8.3.12 RemoveGroupLength()

```
bool gdcm::Anonymizer::RemoveGroupLength ( )
```

Main function that loop over all elements and remove group length.

#### Examples

[ClinicalTrialAnnotate.cxx](#).

### 10.8.3.13 RemovePrivateTags()

```
bool gdcm::Anonymizer::RemovePrivateTags ( )
```

Main function that loop over all elements and remove private tags.

#### Examples

[ClinicalTrialAnnotate.cxx](#).

### 10.8.3.14 RemoveRetired()

```
bool gdcm::Anonymizer::RemoveRetired ( )
```

Main function that loop over all elements and remove retired element.

### 10.8.3.15 Replace() [1/2]

```
bool gdcm::Anonymizer::Replace (
    Tag const & t,
    const char * value )
```

Replace tag with another value, if tag is not found it will be created: WARNING: this function can only execute if tag is a VRASCI

#### Examples

[ClinicalTrialAnnotate.cxx](#), [CreateJPIPDataSet.cxx](#), and [EncapsulateFileInRawData.cxx](#).



### 10.8.3.16 Replace() [2/2]

```
bool gdcm::Anonymizer::Replace (
    Tag const & t,
    const char * value,
    VL const & vl )
```

when the value contains \0, it is a good idea to specify the length. This function is required when dealing with VRBINARy tag

### 10.8.3.17 SetCryptographicMessageSyntax()

```
void gdcm::Anonymizer::SetCryptographicMessageSyntax (
    CryptographicMessageSyntax * cms )
```

Set/Get CMS key that will be used to encrypt the dataset within BasicApplicationLevelConfidentialityProfile.

### 10.8.3.18 SetFile()

```
void gdcm::Anonymizer::SetFile (
    const File & f ) [inline]
```

Set/Get [File](#).

#### Examples

[ClinicalTrialAnnotate.cxx](#), [CreateJPIPDataSet.cxx](#), and [EncapsulateFileInRawData.cxx](#).

The documentation for this class was generated from the following file:

- [gdcmAnonymizer.h](#)

## 10.9 gdcM::AnyEvent Class Reference

```
#include <gdcMEvent.h>
```

Inheritance diagram for gdcM::AnyEvent:

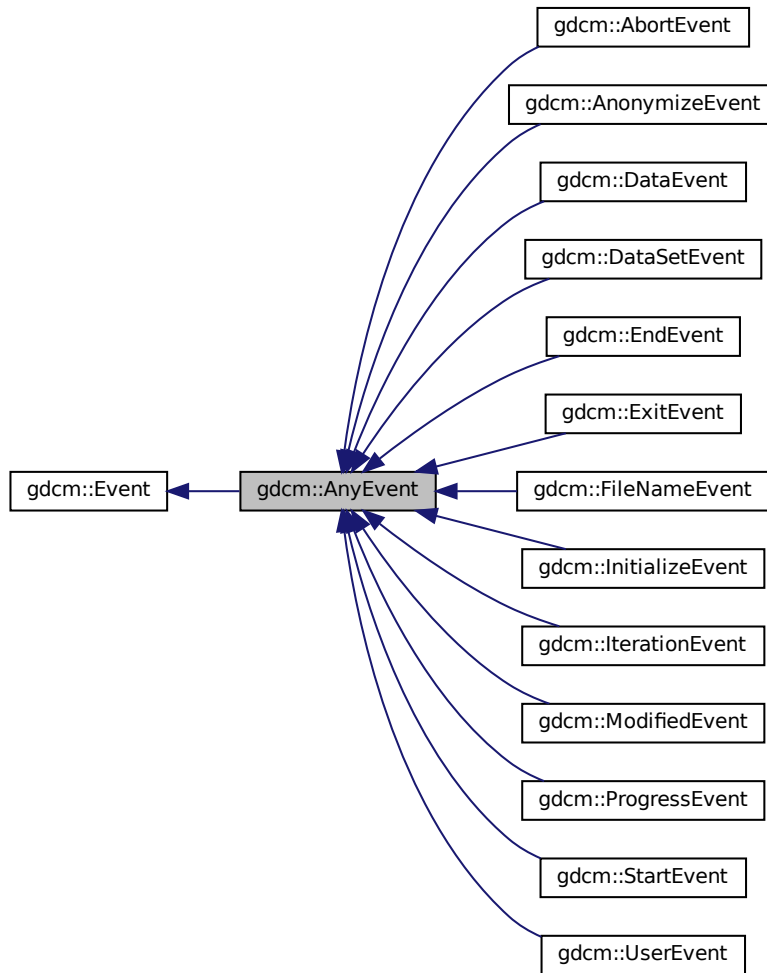

Collaboration diagram for gdcm::AnyEvent:

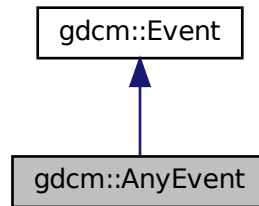

### Additional Inherited Members

The documentation for this class was generated from the following file:

- [gdcmEvent.h](#)

## 10.10 gdcm::network::ApplicationContext Class Reference

[ApplicationContext.](#)

```
#include <gdcmApplicationContext.h>
```

### Public Member Functions

- [ApplicationContext](#) ()
- const char \* [GetName](#) () const
- void [Print](#) (std::ostream &os) const
- std::istream & [Read](#) (std::istream &is)
- void [SetName](#) (const char \*name)
- size\_t [Size](#) () const
- const std::ostream & [Write](#) (std::ostream &os) const

### 10.10.1 Detailed Description

[ApplicationContext.](#)

[Table 9-12 APPLICATION CONTEXT ITEM FIELDS](#)

**Todo** Looks like Application Context can only be 64 bytes at max (see Figure 9-1 / PS 3.8 - 2009 )

## 10.10.2 Constructor & Destructor Documentation

### 10.10.2.1 ApplicationContext()

```
gdcn::network::ApplicationContext::ApplicationContext ( )
```

## 10.10.3 Member Function Documentation

### 10.10.3.1 GetName()

```
const char* gdcn::network::ApplicationContext::GetName ( ) const [inline]
```

### 10.10.3.2 Print()

```
void gdcn::network::ApplicationContext::Print (
    std::ostream & os ) const
```

### 10.10.3.3 Read()

```
std::istream& gdcn::network::ApplicationContext::Read (
    std::istream & is )
```

### 10.10.3.4 SetName()

```
void gdcn::network::ApplicationContext::SetName (
    const char * name ) [inline]
```

### 10.10.3.5 Size()

```
size_t gdcm::network::ApplicationContext::Size ( ) const
```

### 10.10.3.6 Write()

```
const std::ostream& gdcm::network::ApplicationContext::Write (
    std::ostream & os ) const
```

The documentation for this class was generated from the following file:

- [gdcmApplicationContext.h](#)

## 10.11 gdcm::ApplicationEntity Class Reference

[ApplicationEntity](#).

```
#include <gdcmApplicationEntity.h>
```

Collaboration diagram for gdcm::ApplicationEntity:

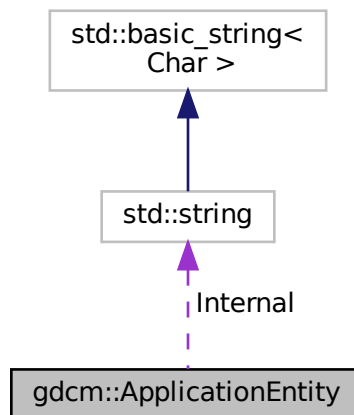

### Public Member Functions

- bool [IsValid](#) () const
- void [Print](#) (std::ostream &os) const
- void [SetBlob](#) (const std::vector< char > &v)
- void [Squeeze](#) ()

## Public Attributes

- std::string [Internal](#)

## Static Public Attributes

- static const unsigned int [MaxLength](#) = 16
- static const unsigned int [MaxNumberOfComponents](#) = 1
- static const char [Padding](#) = ''
- static const char [Separator](#) = ''

### 10.11.1 Detailed Description

[ApplicationEntity](#).

- AE Application Entity
- A string of characters that identifies an Application Entity with leading and trailing spaces (20H) being non-significant. A value consisting solely of spaces shall not be used.
- Default Character Repertoire excluding character code 5CH (the BACKSLASH \ in ISO-IR 6), and control characters LF, FF, CR and ESC.
- 16 bytes maximum

### 10.11.2 Member Function Documentation

#### 10.11.2.1 IsValid()

```
bool gdcM::ApplicationEntity::IsValid ( ) const [inline]
```

#### 10.11.2.2 Print()

```
void gdcM::ApplicationEntity::Print (
    std::ostream & os ) const [inline]
```

### 10.11.2.3 SetBlob()

```
void gdcM::ApplicationEntity::SetBlob (
    const std::vector< char > & v ) [inline]
```

### 10.11.2.4 Squeeze()

```
void gdcM::ApplicationEntity::Squeeze ( ) [inline]
```

## 10.11.3 Member Data Documentation

### 10.11.3.1 Internal

```
std::string gdcM::ApplicationEntity::Internal
```

### 10.11.3.2 MaxLength

```
const unsigned int gdcM::ApplicationEntity::MaxLength = 16 [static]
```

### 10.11.3.3 MaxNumberOfComponents

```
const unsigned int gdcM::ApplicationEntity::MaxNumberOfComponents = 1 [static]
```

### 10.11.3.4 Padding

```
const char gdcM::ApplicationEntity::Padding = ' ' [static]
```

### 10.11.3.5 Separator

```
const char gdcM::ApplicationEntity::Separator = ' ' [static]
```

The documentation for this class was generated from the following file:

- [gdcMApplicationEntity.h](#)

## 10.12 gdcM::network::AReleaseRPPDU Class Reference

[AReleaseRPPDU](#).

```
#include <gdcMAReleaseRPPDU.h>
```

Inheritance diagram for gdcM::network::AReleaseRPPDU:

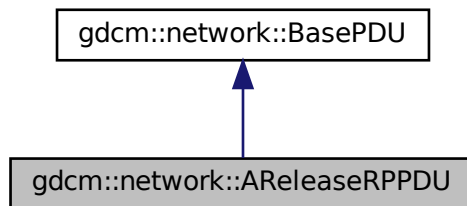

Collaboration diagram for gdcM::network::AReleaseRPPDU:

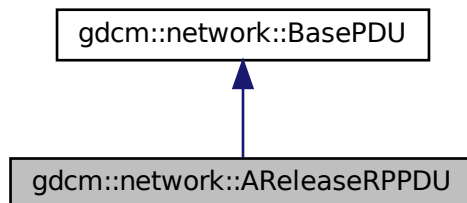



## Public Member Functions

- [AReleaseRPPDU](#) ()
- bool [IsLastFragment](#) () const override
- void [Print](#) (std::ostream &os) const override
- std::istream & [Read](#) (std::istream &is) override
- size\_t [Size](#) () const override
- const std::ostream & [Write](#) (std::ostream &os) const override

### 10.12.1 Detailed Description

[AReleaseRPPDU](#).

[Table 9-25](#) A-RELEASE-RP PDU fields

### 10.12.2 Constructor & Destructor Documentation

#### 10.12.2.1 AReleaseRPPDU()

```
gdcmm::network::AReleaseRPPDU::AReleaseRPPDU ( )
```

### 10.12.3 Member Function Documentation

#### 10.12.3.1 IsLastFragment()

```
bool gdcmm::network::AReleaseRPPDU::IsLastFragment ( ) const [inline], [override], [virtual]
```

Implements [gdcmm::network::BasePDU](#).

#### 10.12.3.2 Print()

```
void gdcmm::network::AReleaseRPPDU::Print (
    std::ostream & os ) const [override], [virtual]
```

Implements [gdcmm::network::BasePDU](#).

### 10.12.3.3 Read()

```
std::istream& gdcmm::network::AReleaseRPPDU::Read (
    std::istream & is ) [override], [virtual]
```

Implements [gdcmm::network::BasePDU](#).

### 10.12.3.4 Size()

```
size_t gdcmm::network::AReleaseRPPDU::Size ( ) const [override], [virtual]
```

Implements [gdcmm::network::BasePDU](#).

### 10.12.3.5 Write()

```
const std::ostream& gdcmm::network::AReleaseRPPDU::Write (
    std::ostream & os ) const [override], [virtual]
```

Implements [gdcmm::network::BasePDU](#).

The documentation for this class was generated from the following file:

- [gdcmmAReleaseRPPDU.h](#)

## 10.13 gdcmm::network::AReleaseRQPDU Class Reference

[AReleaseRQPDU](#).

```
#include <gdcmmAReleaseRQPDU.h>
```

Inheritance diagram for gdcmm::network::AReleaseRQPDU:

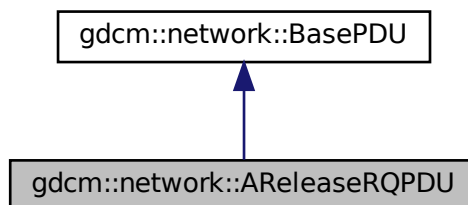

Collaboration diagram for gdcm::network::AReleaseRQPDU:

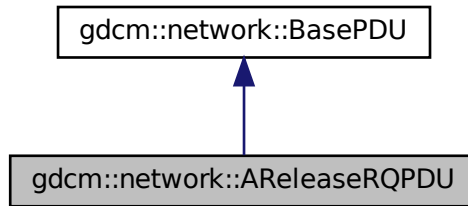

## Public Member Functions

- [AReleaseRQPDU](#) ()
- bool [IsLastFragment](#) () const override
- void [Print](#) (std::ostream &os) const override
- std::istream & [Read](#) (std::istream &is) override
- size\_t [Size](#) () const override
- const std::ostream & [Write](#) (std::ostream &os) const override

### 10.13.1 Detailed Description

[AReleaseRQPDU](#).

[Table 9-24](#) A-RELEASE-RQ PDU FIELDS

### 10.13.2 Constructor & Destructor Documentation

#### 10.13.2.1 AReleaseRQPDU()

```
gdcm::network::AReleaseRQPDU::AReleaseRQPDU ( )
```

### 10.13.3 Member Function Documentation

### 10.13.3.1 IsLastFragment()

```
bool gdcn::network::AReleaseRQPDU::IsLastFragment ( ) const [inline], [override], [virtual]
```

Implements [gdcn::network::BasePDU](#).

### 10.13.3.2 Print()

```
void gdcn::network::AReleaseRQPDU::Print (
    std::ostream & os ) const [override], [virtual]
```

Implements [gdcn::network::BasePDU](#).

### 10.13.3.3 Read()

```
std::istream& gdcn::network::AReleaseRQPDU::Read (
    std::istream & is ) [override], [virtual]
```

Implements [gdcn::network::BasePDU](#).

### 10.13.3.4 Size()

```
size_t gdcn::network::AReleaseRQPDU::Size ( ) const [override], [virtual]
```

Implements [gdcn::network::BasePDU](#).

### 10.13.3.5 Write()

```
const std::ostream& gdcn::network::AReleaseRQPDU::Write (
    std::ostream & os ) const [override], [virtual]
```

Implements [gdcn::network::BasePDU](#).

The documentation for this class was generated from the following file:

- [gdcnAReleaseRQPDU.h](#)

## 10.14 gdcm::network::ARTIMTimer Class Reference

[ARTIMTimer](#).

```
#include <gdcmARTIMTimer.h>
```

### Public Member Functions

- [ARTIMTimer](#) ()
- double [GetElapsedTime](#) () const
- bool [GetHasExpired](#) () const
- double [GetTimeout](#) () const
- void [SetTimeout](#) (double inTimeout)
- void [Start](#) ()
- void [Stop](#) ()

### 10.14.1 Detailed Description

[ARTIMTimer](#).

This file contains the code for the ARTIM timer.

Basically, the ARTIM timer will just get the wall time when it's started, and then can be queried for the current time, and then can be stopped (ie, the start time reset).

Because we're trying to do this without threading, we should be able to 'start' the ARTIM timer by this mechanism, and then when waiting for a particular response, tight loop that with sleep calls and determinations of when the ARTIM timer has reached its peak. As such, this isn't a strict 'timer' in the traditional sense of the word, but more of a time keeper.

There can be only one ARTIM timer per connection.

### 10.14.2 Constructor & Destructor Documentation

#### 10.14.2.1 ARTIMTimer()

```
gdcm::network::ARTIMTimer::ARTIMTimer ( )
```

### 10.14.3 Member Function Documentation

### 10.14.3.1 GetElapsedTime()

```
double gdcM::network::ARTIMTimer::GetElapsedTime ( ) const
```

### 10.14.3.2 GetHasExpired()

```
bool gdcM::network::ARTIMTimer::GetHasExpired ( ) const
```

### 10.14.3.3 GetTimeout()

```
double gdcM::network::ARTIMTimer::GetTimeout ( ) const
```

### 10.14.3.4 SetTimeout()

```
void gdcM::network::ARTIMTimer::SetTimeout (
    double inTimeout )
```

### 10.14.3.5 Start()

```
void gdcM::network::ARTIMTimer::Start ( )
```

### 10.14.3.6 Stop()

```
void gdcM::network::ARTIMTimer::Stop ( )
```

The documentation for this class was generated from the following file:

- [gdcMARTIMTimer.h](#)

## 10.15 gdcM::ASN1 Class Reference

Class for [ASN1](#).

```
#include <gdcMASN1.h>
```

## Public Member Functions

- [ASN1](#) ()
- [ASN1](#) (const [ASN1](#) &)=delete
- [~ASN1](#) ()
- void [operator=](#) (const [ASN1](#) &)=delete

## Static Public Member Functions

- static bool [ParseDump](#) (const char \*array, size\_t length)
- static bool [ParseDumpFile](#) (const char \*filename)

## Protected Member Functions

- int [TestPBKDF2](#) ()

### 10.15.1 Detailed Description

Class for [ASN1](#).

### 10.15.2 Constructor & Destructor Documentation

#### 10.15.2.1 [ASN1\(\)](#) [1/2]

```
gdcmm::ASN1::ASN1 ( )
```

#### 10.15.2.2 [~ASN1\(\)](#)

```
gdcmm::ASN1::~~ASN1 ( )
```

#### 10.15.2.3 [ASN1\(\)](#) [2/2]

```
gdcmm::ASN1::ASN1 (
    const ASN1 & ) [delete]
```

## 10.15.3 Member Function Documentation

### 10.15.3.1 operator=()

```
void gdcm::ASN1::operator= (
    const ASN1 & ) [delete]
```

### 10.15.3.2 ParseDump()

```
static bool gdcm::ASN1::ParseDump (
    const char * array,
    size_t length ) [static]
```

### 10.15.3.3 ParseDumpFile()

```
static bool gdcm::ASN1::ParseDumpFile (
    const char * filename ) [static]
```

### 10.15.3.4 TestPBKDF2()

```
int gdcm::ASN1::TestPBKDF2 ( ) [protected]
```

The documentation for this class was generated from the following file:

- [gdcmASN1.h](#)

## 10.16 gdcm::network::AsynchronousOperationsWindowSub Class Reference

[AsynchronousOperationsWindowSub](#).

```
#include <gdcmAsynchronousOperationsWindowSub.h>
```



## Public Member Functions

- [AsynchronousOperationsWindowSub](#) ()
- void [Print](#) (std::ostream &os) const
- std::istream & [Read](#) (std::istream &is)
- size\_t [Size](#) () const
- const std::ostream & [Write](#) (std::ostream &os) const

### 10.16.1 Detailed Description

[AsynchronousOperationsWindowSub](#).

PS 3.7 [Table D.3-7](#) ASYNCHRONOUS OPERATIONS WINDOW SUB-ITEM FIELDS (A-ASSOCIATE-RQ)

### 10.16.2 Constructor & Destructor Documentation

#### 10.16.2.1 AsynchronousOperationsWindowSub()

```
gdcm::network::AsynchronousOperationsWindowSub::AsynchronousOperationsWindowSub ( )
```

### 10.16.3 Member Function Documentation

#### 10.16.3.1 Print()

```
void gdcm::network::AsynchronousOperationsWindowSub::Print (
    std::ostream & os ) const
```

#### 10.16.3.2 Read()

```
std::istream& gdcm::network::AsynchronousOperationsWindowSub::Read (
    std::istream & is )
```

### 10.16.3.3 Size()

```
size_t gdcM::network::AsynchronousOperationsWindowSub::Size ( ) const
```

### 10.16.3.4 Write()

```
const std::ostream& gdcM::network::AsynchronousOperationsWindowSub::Write (
    std::ostream & os ) const
```

The documentation for this class was generated from the following file:

- [gdcMAsynchronousOperationsWindowSub.h](#)

## 10.17 gdcM::Attribute< Group, Element, TVR, TVM > Class Template Reference

[Attribute](#) class This class use template metaprograming tricks to let the user know when the template instantiation does not match the public dictionary.

```
#include <gdcMAttribute.h>
```

Collaboration diagram for gdcM::Attribute< Group, Element, TVR, TVM >:

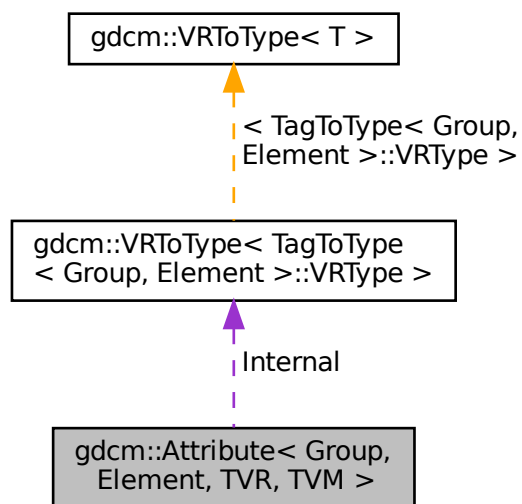

## Public Types

- enum { [VMType](#) = VMToLength<TVM>::Length }
- typedef [VRToType](#)< TVR >::Type [ArrayType](#)

## Public Member Functions

- [GDCM\\_STATIC\\_ASSERT](#) (((((VR::VRType) TVR &VR::VR\_VM1) &&((VM::VMType) TVM==VM::VM1))|!((VR::VRType) TVR &VR::VR\_VM1)))
- [GDCM\\_STATIC\\_ASSERT](#) (((VM::VMType) TVM &(VM::VMType)(TagToType< Group, Element >::VMType)))
- [GDCM\\_STATIC\\_ASSERT](#) (((VR::VRType) TVR &(VR::VRType)(TagToType< Group, Element >::VRType)))
- [DataElement](#) [GetAsDataElement](#) () const
- unsigned int [GetNumberOfValues](#) () const
- [ArrayType](#) & [GetValue](#) (unsigned int idx=0)
- [ArrayType](#) const & [GetValue](#) (unsigned int idx=0) const
- const [ArrayType](#) \* [GetValues](#) () const
- bool [operator!=](#) (const [Attribute](#) &att) const
- bool [operator<](#) (const [Attribute](#) &att) const
- bool [operator==](#) (const [Attribute](#) &att) const
- [ArrayType](#) & [operator\[\]](#) (unsigned int idx)
- [ArrayType](#) const & [operator\[\]](#) (unsigned int idx) const
- void [Print](#) (std::ostream &os) const
- void [Set](#) ([DataSet](#) const &ds)
- void [SetFromDataElement](#) ([DataElement](#) const &de)
- void [SetFromDataSet](#) ([DataSet](#) const &ds)
- void [SetValue](#) ([ArrayType](#) v, unsigned int idx=0)
- void [SetValues](#) (const [ArrayType](#) \*array, unsigned int numel=[VMType](#))

## Static Public Member Functions

- static [VM](#) [GetDictVM](#) ()
- static [VR](#) [GetDictVR](#) ()
- static [Tag](#) [GetTag](#) ()
- static [VM](#) [GetVM](#) ()
- static [VR](#) [GetVR](#) ()

## Public Attributes

- [ArrayType](#) [Internal](#) [[VMToLength](#)< TVM >::Length]

## Protected Member Functions

- void [SetByteValue](#) (const [ByteValue](#) \*bv)
- void [SetByteValueNoSwap](#) (const [ByteValue](#) \*bv)

### 10.17.1 Detailed Description

```
template<uint16_t Group, uint16_t Element, long long TVR = TagToType<Group, Element>::VRType, int TVM = TagToType<Group, Element>::VMType>
class gdcmm::Attribute< Group, Element, TVR, TVM >
```

[Attribute](#) class This class use template metaprograming tricks to let the user know when the template instantiation does not match the public dictionary.

Typical example that compile is: `Attribute<0x0008,0x9007> a = {"ORIGINAL","PRIMARY","T1","NONE"};`

Examples that will NOT compile are:

```
Attribute<0x0018,0x1182, VR::IS, VM::VM1> fd1 = {}; // not enough parameters
Attribute<0x0018,0x1182, VR::IS, VM::VM2> fd2 = {0,1,2}; // too many initializers
Attribute<0x0018,0x1182, VR::IS, VM::VM3> fd3 = {0,1,2}; // VM3 is not valid
Attribute<0x0018,0x1182, VR::UL, VM::VM2> fd3 = {0,1}; // UL is not valid VR
```

#### Examples

[CreateFakeRTDOSE.cxx](#), [CreateJPIPDataSet.cxx](#), [DeriveSeries.cxx](#), [Extracting\\_All\\_Resolution.cxx](#), [Fake\\_Image\\_Using\\_Stream\\_In](#), [FixOrientation.cxx](#), [GenFakeIdentifyFile.cxx](#), [GetSequenceUltrasound.cxx](#), [HelloWorld.cxx](#), [LargeVRDSEExplicit.cxx](#), [PatchFile.cxx](#), [ReadAndDumpDICOMDIR2.cxx](#), [SortImage.cxx](#), [StreamImageReaderTest.cxx](#), [VolumeSorter.cxx](#), [gdcmmrtionplan.cxx](#), [gdcmmrtplan.cxx](#), [pmsct\\_rgb1.cxx](#), and [rle2img.cxx](#).

### 10.17.2 Member Typedef Documentation

#### 10.17.2.1 ArrayType

```
template<uint16_t Group, uint16_t Element, long long TVR = TagToType<Group, Element>::VRType, int TVM = TagToType<Group, Element>::VMType>
typedef VRToType<TVR>::Type gdcmm::Attribute< Group, Element, TVR, TVM >::ArrayType
```

#### Examples

[ReadAndPrintAttributes.cxx](#).

### 10.17.3 Member Enumeration Documentation

#### 10.17.3.1 anonymous enum

```
template<uint16_t Group, uint16_t Element, long long TVR = TagToType<Group, Element>::VRType, int TVM = TagToType<Group, Element>::VMType>
anonymous enum
```

## Enumerator

VMTyPe	
--------	--

## 10.17.4 Member Function Documentation

### 10.17.4.1 GDCM\_STATIC\_ASSERT() [1/3]

```
template<uint16_t Group, uint16_t Element, long long TVR = TagToType<Group, Element>::VRType, int
TVM = TagToType<Group, Element>::VMTyPe>
gdcm::Attribute< Group, Element, TVR, TVM >::GDCM_STATIC_ASSERT (
    (((VR::VRType) TVR &VR::VR_VM1) &&((VM::VMTyPe) TVM==VM::VM1))||!((VR::VRType) TVR
&VR::VR_VM1)) )
```

### 10.17.4.2 GDCM\_STATIC\_ASSERT() [2/3]

```
template<uint16_t Group, uint16_t Element, long long TVR = TagToType<Group, Element>::VRType, int
TVM = TagToType<Group, Element>::VMTyPe>
gdcm::Attribute< Group, Element, TVR, TVM >::GDCM_STATIC_ASSERT (
    ((VM::VMTyPe) TVM &(VM::VMTyPe) (TagToType< Group, Element >::VMTyPe)) )
```

### 10.17.4.3 GDCM\_STATIC\_ASSERT() [3/3]

```
template<uint16_t Group, uint16_t Element, long long TVR = TagToType<Group, Element>::VRType, int
TVM = TagToType<Group, Element>::VMTyPe>
gdcm::Attribute< Group, Element, TVR, TVM >::GDCM_STATIC_ASSERT (
    ((VR::VRType) TVR &(VR::VRType) (TagToType< Group, Element >::VRType)) )
```

### 10.17.4.4 GetAsDataElement()

```
template<uint16_t Group, uint16_t Element, long long TVR = TagToType<Group, Element>::VRType, int
TVM = TagToType<Group, Element>::VMTyPe>
DataElement gdcm::Attribute< Group, Element, TVR, TVM >::GetAsDataElement ( ) const [inline]
```

#### Examples

[CreateFakeRTDOSE.cxx](#), [CreateJPIPDataset.cxx](#), [Extracting\\_All\\_Resolution.cxx](#), [Fake\\_Image\\_Using\\_Stream\\_Image\\_Writer.cxx](#), [FixOrientation.cxx](#), [GenFakeIdentifyFile.cxx](#), [HelloWorld.cxx](#), [LargeVRDSEExplicit.cxx](#), [PatchFile.cxx](#), and [StreamImageReaderTest.cxx](#).

References [gdcm::DataElement::GetVR\(\)](#), [gdcm::DataElement::SetByteValue\(\)](#), and [gdcm::DataElement::SetVR\(\)](#).

#### 10.17.4.5 GetDictVM()

```
template<uint16_t Group, uint16_t Element, long long TVR = TagToType<Group, Element>::VRType, int
TVM = TagToType<Group, Element>::VMType>
static VM gdcM::Attribute< Group, Element, TVR, TVM >::GetDictVM ( ) [inline], [static]
```

#### 10.17.4.6 GetDictVR()

```
template<uint16_t Group, uint16_t Element, long long TVR = TagToType<Group, Element>::VRType, int
TVM = TagToType<Group, Element>::VMType>
static VR gdcM::Attribute< Group, Element, TVR, TVM >::GetDictVR ( ) [inline], [static]
```

#### 10.17.4.7 GetNumberOfValues()

```
template<uint16_t Group, uint16_t Element, long long TVR = TagToType<Group, Element>::VRType, int
TVM = TagToType<Group, Element>::VMType>
unsigned int gdcM::Attribute< Group, Element, TVR, TVM >::GetNumberOfValues ( ) const [inline]
```

#### Examples

[LargeVRDSExplicit.cxx](#).

Referenced by `gdcM::Attribute< Group, Element, TVR, TVM >::operator<()>`, and `gdcM::Attribute< Group, Element, TVR, VM::VM1 >::operator<()>`.

#### 10.17.4.8 GetTag()

```
template<uint16_t Group, uint16_t Element, long long TVR = TagToType<Group, Element>::VRType, int
TVM = TagToType<Group, Element>::VMType>
static Tag gdcM::Attribute< Group, Element, TVR, TVM >::GetTag ( ) [inline], [static]
```

#### Examples

[PatchFile.cxx](#), [gdcMrtionplan.cxx](#), and [gdcMrtplan.cxx](#).

**10.17.4.9 GetValue()** [1/2]

```
template<uint16_t Group, uint16_t Element, long long TVR = TagToType<Group, Element>::VRType, int
TVM = TagToType<Group, Element>::VMType>
ArrayType& gdcm::Attribute< Group, Element, TVR, TVM >::GetValue (
    unsigned int idx = 0 ) [inline]
```

**Examples**

[DeriveSeries.cxx](#), [FixOrientation.cxx](#), [GetSequenceUltrasound.cxx](#), [PatchFile.cxx](#), [ReadAndDumpDICOMDIR2.cxx](#), [gdcmrtionplan.cxx](#), [gdcmrtplan.cxx](#), [pmsct\\_rgb1.cxx](#), and [rle2img.cxx](#).

**10.17.4.10 GetValue()** [2/2]

```
template<uint16_t Group, uint16_t Element, long long TVR = TagToType<Group, Element>::VRType, int
TVM = TagToType<Group, Element>::VMType>
ArrayType const& gdcm::Attribute< Group, Element, TVR, TVM >::GetValue (
    unsigned int idx = 0 ) const [inline]
```

**10.17.4.11 GetValues()**

```
template<uint16_t Group, uint16_t Element, long long TVR = TagToType<Group, Element>::VRType, int
TVM = TagToType<Group, Element>::VMType>
const ArrayType* gdcm::Attribute< Group, Element, TVR, TVM >::GetValues ( ) const [inline]
```

**Examples**

[FixOrientation.cxx](#), [LargeVRDSExplicit.cxx](#), [gdcmrtionplan.cxx](#), and [gdcmrtplan.cxx](#).

Referenced by `gdcm::Attribute< Group, Element, TVR, TVM >::operator!=()`, `gdcm::Attribute< Group, Element, TVR, VM::VM1 >::operator!=()`, `gdcm::Attribute< Group, Element, TVR, TVM >::operator<()`, `gdcm::Attribute< Group, Element, TVR, VM::VM1 >::operator<()`, `gdcm::Attribute< Group, Element, TVR, TVM >::operator==(())`, and `gdcm::Attribute< Group, Element, TVR, VM::VM1 >::operator==(())`.

**10.17.4.12 GetVM()**

```
template<uint16_t Group, uint16_t Element, long long TVR = TagToType<Group, Element>::VRType, int
TVM = TagToType<Group, Element>::VMType>
static VM gdcm::Attribute< Group, Element, TVR, TVM >::GetVM ( ) [inline], [static]
```

**10.17.4.13 GetVR()**

```
template<uint16_t Group, uint16_t Element, long long TVR = TagToType<Group, Element>::VRType, int
TVM = TagToType<Group, Element>::VMType>
static VR gdcM::Attribute< Group, Element, TVR, TVM >::GetVR ( ) [inline], [static]
```

**10.17.4.14 operator"!=(**

```
template<uint16_t Group, uint16_t Element, long long TVR = TagToType<Group, Element>::VRType, int
TVM = TagToType<Group, Element>::VMType>
bool gdcM::Attribute< Group, Element, TVR, TVM >::operator!= (
    const Attribute< Group, Element, TVR, TVM > & att ) const [inline]
```

References `gdcM::Attribute< Group, Element, TVR, TVM >::GetValues()`.

**10.17.4.15 operator<**

```
template<uint16_t Group, uint16_t Element, long long TVR = TagToType<Group, Element>::VRType, int
TVM = TagToType<Group, Element>::VMType>
bool gdcM::Attribute< Group, Element, TVR, TVM >::operator< (
    const Attribute< Group, Element, TVR, TVM > & att ) const [inline]
```

References `gdcM::Attribute< Group, Element, TVR, TVM >::GetNumberOfValues()`, and `gdcM::Attribute< Group, Element, TVR, TVM >::GetValues()`.

**10.17.4.16 operator==**

```
template<uint16_t Group, uint16_t Element, long long TVR = TagToType<Group, Element>::VRType, int
TVM = TagToType<Group, Element>::VMType>
bool gdcM::Attribute< Group, Element, TVR, TVM >::operator== (
    const Attribute< Group, Element, TVR, TVM > & att ) const [inline]
```

References `gdcM::Attribute< Group, Element, TVR, TVM >::GetValues()`.

**10.17.4.17 operator[]** [1/2]

```
template<uint16_t Group, uint16_t Element, long long TVR = TagToType<Group, Element>::VRType, int
TVM = TagToType<Group, Element>::VMType>
ArrayType& gdcM::Attribute< Group, Element, TVR, TVM >::operator[] (
    unsigned int idx ) [inline]
```



#### 10.17.4.18 operator[]() [2/2]

```
template<uint16_t Group, uint16_t Element, long long TVR = TagToType<Group, Element>::VRType, int
TVM = TagToType<Group, Element>::VMType>
ArrayType const& gdcm::Attribute< Group, Element, TVR, TVM >::operator[] (
    unsigned int idx ) const [inline]
```

#### 10.17.4.19 Print()

```
template<uint16_t Group, uint16_t Element, long long TVR = TagToType<Group, Element>::VRType, int
TVM = TagToType<Group, Element>::VMType>
void gdcm::Attribute< Group, Element, TVR, TVM >::Print (
    std::ostream & os ) const [inline]
```

#### 10.17.4.20 Set()

```
template<uint16_t Group, uint16_t Element, long long TVR = TagToType<Group, Element>::VRType, int
TVM = TagToType<Group, Element>::VMType>
void gdcm::Attribute< Group, Element, TVR, TVM >::Set (
    DataSet const & ds ) [inline]
```

#### Examples

[LargeVRDSExplicit.cxx](#), [SortImage.cxx](#), and [VolumeSorter.cxx](#).

References [gdcm::DataSet::GetDataElement\(\)](#).

#### 10.17.4.21 SetByteValue()

```
template<uint16_t Group, uint16_t Element, long long TVR = TagToType<Group, Element>::VRType, int
TVM = TagToType<Group, Element>::VMType>
void gdcm::Attribute< Group, Element, TVR, TVM >::SetByteValue (
    const ByteValue * bv ) [inline], [protected]
```

References [gdcm::ByteValue::GetLength\(\)](#), and [gdcm::ByteValue::GetPointer\(\)](#).

#### 10.17.4.22 SetByteValueNoSwap()

```
template<uint16_t Group, uint16_t Element, long long TVR = TagToType<Group, Element>::VRType, int
TVM = TagToType<Group, Element>::VMType>
void gdcM::Attribute< Group, Element, TVR, TVM >::SetByteValueNoSwap (
    const ByteValue * bv ) [inline], [protected]
```

References `gdcM::ByteValue::GetLength()`, and `gdcM::ByteValue::GetPointer()`.

#### 10.17.4.23 SetFromDataElement()

```
template<uint16_t Group, uint16_t Element, long long TVR = TagToType<Group, Element>::VRType, int
TVM = TagToType<Group, Element>::VMType>
void gdcM::Attribute< Group, Element, TVR, TVM >::SetFromDataElement (
    DataElement const & de ) [inline]
```

##### Examples

[GetSequenceUltrasound.cxx](#), [LargeVRDSExplicit.cxx](#), [PatchFile.cxx](#), [ReadAndDumpDICOMDIR2.cxx](#), [gdcMrtionplan.cxx](#),  
and [gdcMrtplan.cxx](#).

References `gdcM::DataElement::GetByteValue()`, `gdcM::DataElement::GetTag()`, `gdcM::DataElement::GetVR()`, and  
`gdcM::DataElement::IsEmpty()`.

#### 10.17.4.24 SetFromDataSet()

```
template<uint16_t Group, uint16_t Element, long long TVR = TagToType<Group, Element>::VRType, int
TVM = TagToType<Group, Element>::VMType>
void gdcM::Attribute< Group, Element, TVR, TVM >::SetFromDataSet (
    DataSet const & ds ) [inline]
```

##### Examples

[DeriveSeries.cxx](#), [FixOrientation.cxx](#), [pmsct\\_rgb1.cxx](#), and [rle2img.cxx](#).

References `gdcM::DataSet::FindDataElement()`, and `gdcM::DataSet::GetDataElement()`.

#### 10.17.4.25 SetValue()

```
template<uint16_t Group, uint16_t Element, long long TVR = TagToType<Group, Element>::VRType, int
TVM = TagToType<Group, Element>::VMType>
void gdcm::Attribute< Group, Element, TVR, TVM >::SetValue (
    ArrayType v,
    unsigned int idx = 0 ) [inline]
```

##### Examples

[CreateFakeRTDOSE.cxx](#), [CreateJPIPDataSet.cxx](#), [FixOrientation.cxx](#), [HelloWorld.cxx](#), [LargeVRDSExplicit.cxx](#), and [PatchFile.cxx](#).

#### 10.17.4.26 SetValues()

```
template<uint16_t Group, uint16_t Element, long long TVR = TagToType<Group, Element>::VRType, int
TVM = TagToType<Group, Element>::VMType>
void gdcm::Attribute< Group, Element, TVR, TVM >::SetValues (
    const ArrayType * array,
    unsigned int numel = VMType ) [inline]
```

##### Examples

[FixOrientation.cxx](#), and [LargeVRDSExplicit.cxx](#).

### 10.17.5 Member Data Documentation

#### 10.17.5.1 Internal

```
template<uint16_t Group, uint16_t Element, long long TVR = TagToType<Group, Element>::VRType, int
TVM = TagToType<Group, Element>::VMType>
ArrayType gdcm::Attribute< Group, Element, TVR, TVM >::Internal[VMTolength< TVM >::Length]
```

The documentation for this class was generated from the following file:

- [gdcmAttribute.h](#)

## 10.18 `gdcM::Attribute< Group, Element, TVR, VM::VM1 >` Class Template Reference

```
#include <gdcMAttribute.h>
```

Collaboration diagram for `gdcM::Attribute< Group, Element, TVR, VM::VM1 >`:

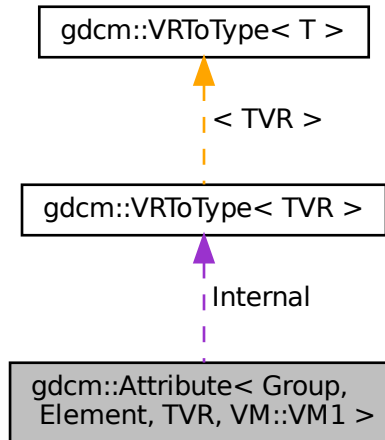

### Public Types

- enum { `VMType` = `VMToLength<VM::VM1>::Length` }
- typedef `VRToType< TVR >::Type` `ArrayType`

### Public Member Functions

- `GDCM_STATIC_ASSERT` (((((VR::VRType) TVR &VR::VR\_VM1) &&((VM::VMType) VM::VM1==VM::VM1))|!((VR::VRType) TVR &VR::VR\_VM1)))
- `GDCM_STATIC_ASSERT` (((VM::VMType) VM::VM1 &(VM::VMType)(TagToType< Group, Element >::VMType)))
- `GDCM_STATIC_ASSERT` (((VR::VRType) TVR &(VR::VRType)(TagToType< Group, Element >::VRType)))
- `GDCM_STATIC_ASSERT` (VMToLength< VM::VM1 >::Length==1)
- `DataElement` `GetAsDataElement` () const
- unsigned int `GetNumberOfValues` () const
- `ArrayType` & `GetValue` ()
- `ArrayType` const & `GetValue` () const
- const `ArrayType` \* `GetValues` () const
- bool `operator!=` (const `Attribute` &att) const
- bool `operator<` (const `Attribute` &att) const
- bool `operator==` (const `Attribute` &att) const

- void [Print](#) (std::ostream &os) const
- void [Set](#) ([DataSet](#) const &ds)
- void [SetFromDataElement](#) ([DataElement](#) const &de)
- void [SetFromDataSet](#) ([DataSet](#) const &ds)
- void [SetValue](#) ([ArrayType](#) v)

## Static Public Member Functions

- static [VM GetDictVM](#) ()
- static [VR GetDictVR](#) ()
- static [Tag GetTag](#) ()
- static [VM GetVM](#) ()
- static [VR GetVR](#) ()

## Public Attributes

- [ArrayType](#) Internal

## Protected Member Functions

- void [SetByteValue](#) (const [ByteValue](#) \*bv)
- void [SetByteValueNoSwap](#) (const [ByteValue](#) \*bv)

## 10.18.1 Member Typedef Documentation

### 10.18.1.1 ArrayType

```
template<uint16_t Group, uint16_t Element, long long TVR>
typedef VRToType<TVR>::Type gdcM::Attribute< Group, Element, TVR, VM::VM1 >::ArrayType
```

## 10.18.2 Member Enumeration Documentation

### 10.18.2.1 anonymous enum

```
template<uint16_t Group, uint16_t Element, long long TVR>
anonymous enum
```

## Enumerator

VMType	
--------	--

### 10.18.3 Member Function Documentation

#### 10.18.3.1 GDCM\_STATIC\_ASSERT() [1/4]

```
template<uint16_t Group, uint16_t Element, long long TVR>
gdcmm::Attribute< Group, Element, TVR, VM::VM1 >::GDCM_STATIC_ASSERT (
    (((VR::VRType) TVR &VR::VR_VM1) &&((VM::VMType) VM::VM1==VM::VM1))||!((VR::VRType)
TVR &VR::VR_VM1)) )
```

#### 10.18.3.2 GDCM\_STATIC\_ASSERT() [2/4]

```
template<uint16_t Group, uint16_t Element, long long TVR>
gdcmm::Attribute< Group, Element, TVR, VM::VM1 >::GDCM_STATIC_ASSERT (
    ((VM::VMType) VM::VM1 &(VM::VMType)(TagToType< Group, Element >::VMType)) )
```

#### 10.18.3.3 GDCM\_STATIC\_ASSERT() [3/4]

```
template<uint16_t Group, uint16_t Element, long long TVR>
gdcmm::Attribute< Group, Element, TVR, VM::VM1 >::GDCM_STATIC_ASSERT (
    ((VR::VRType) TVR &(VR::VRType)(TagToType< Group, Element >::VRType)) )
```

#### 10.18.3.4 GDCM\_STATIC\_ASSERT() [4/4]

```
template<uint16_t Group, uint16_t Element, long long TVR>
gdcmm::Attribute< Group, Element, TVR, VM::VM1 >::GDCM_STATIC_ASSERT (
    VMToLength< VM::VM1 >::Length = =1 )
```

### 10.18.3.5 GetAsDataElement()

```
template<uint16_t Group, uint16_t Element, long long TVR>
DataElement gdcmm::Attribute< Group, Element, TVR, VM::VM1 >::GetAsDataElement ( ) const [inline]
```

References gdcmm::DataElement::GetVR(), gdcmm::DataElement::SetByteValue(), and gdcmm::DataElement::SetVR().

### 10.18.3.6 GetDictVM()

```
template<uint16_t Group, uint16_t Element, long long TVR>
static VM gdcmm::Attribute< Group, Element, TVR, VM::VM1 >::GetDictVM ( ) [inline], [static]
```

### 10.18.3.7 GetDictVR()

```
template<uint16_t Group, uint16_t Element, long long TVR>
static VR gdcmm::Attribute< Group, Element, TVR, VM::VM1 >::GetDictVR ( ) [inline], [static]
```

### 10.18.3.8 GetNumberOfValues()

```
template<uint16_t Group, uint16_t Element, long long TVR>
unsigned int gdcmm::Attribute< Group, Element, TVR, VM::VM1 >::GetNumberOfValues ( ) const [inline]
```

### 10.18.3.9 GetTag()

```
template<uint16_t Group, uint16_t Element, long long TVR>
static Tag gdcmm::Attribute< Group, Element, TVR, VM::VM1 >::GetTag ( ) [inline], [static]
```

### 10.18.3.10 GetValue() [1/2]

```
template<uint16_t Group, uint16_t Element, long long TVR>
ArrayType& gdcmm::Attribute< Group, Element, TVR, VM::VM1 >::GetValue ( ) [inline]
```

**10.18.3.11 GetValue()** [2/2]

```
template<uint16_t Group, uint16_t Element, long long TVR>
ArrayType const& gdcM::Attribute< Group, Element, TVR, VM::VM1 >::GetValue ( ) const [inline]
```

**10.18.3.12 GetValues()**

```
template<uint16_t Group, uint16_t Element, long long TVR>
const ArrayType* gdcM::Attribute< Group, Element, TVR, VM::VM1 >::GetValues ( ) const [inline]
```

**10.18.3.13 GetVM()**

```
template<uint16_t Group, uint16_t Element, long long TVR>
static VM gdcM::Attribute< Group, Element, TVR, VM::VM1 >::GetVM ( ) [inline], [static]
```

**10.18.3.14 GetVR()**

```
template<uint16_t Group, uint16_t Element, long long TVR>
static VR gdcM::Attribute< Group, Element, TVR, VM::VM1 >::GetVR ( ) [inline], [static]
```

**10.18.3.15 operator"!="()**

```
template<uint16_t Group, uint16_t Element, long long TVR>
bool gdcM::Attribute< Group, Element, TVR, VM::VM1 >::operator!= (
    const Attribute< Group, Element, TVR, VM::VM1 > & att ) const [inline]
```

References gdcM::Attribute< Group, Element, TVR, TVM >::GetValues().

**10.18.3.16 operator<()**

```
template<uint16_t Group, uint16_t Element, long long TVR>
bool gdcM::Attribute< Group, Element, TVR, VM::VM1 >::operator< (
    const Attribute< Group, Element, TVR, VM::VM1 > & att ) const [inline]
```

References gdcM::Attribute< Group, Element, TVR, TVM >::GetNumberOfValues(), and gdcM::Attribute< Group, Element, TVR, TVM >::GetValues().



### 10.18.3.17 operator==( )

```
template<uint16_t Group, uint16_t Element, long long TVR>
bool gdcmm::Attribute< Group, Element, TVR, VM::VM1 >::operator==(
    const Attribute< Group, Element, TVR, VM::VM1 > & att ) const [inline]
```

References gdcmm::Attribute< Group, Element, TVR, TVM >::GetValues().

### 10.18.3.18 Print()

```
template<uint16_t Group, uint16_t Element, long long TVR>
void gdcmm::Attribute< Group, Element, TVR, VM::VM1 >::Print (
    std::ostream & os ) const [inline]
```

### 10.18.3.19 Set()

```
template<uint16_t Group, uint16_t Element, long long TVR>
void gdcmm::Attribute< Group, Element, TVR, VM::VM1 >::Set (
    DataSet const & ds ) [inline]
```

References gdcmm::DataSet::GetDataElement().

### 10.18.3.20 SetByteValue()

```
template<uint16_t Group, uint16_t Element, long long TVR>
void gdcmm::Attribute< Group, Element, TVR, VM::VM1 >::SetByteValue (
    const ByteValue * bv ) [inline], [protected]
```

References gdcmm::ByteValue::GetLength(), and gdcmm::ByteValue::GetPointer().

### 10.18.3.21 SetByteValueNoSwap()

```
template<uint16_t Group, uint16_t Element, long long TVR>
void gdcmm::Attribute< Group, Element, TVR, VM::VM1 >::SetByteValueNoSwap (
    const ByteValue * bv ) [inline], [protected]
```

References gdcmm::ByteValue::GetLength(), and gdcmm::ByteValue::GetPointer().

### 10.18.3.22 SetFromDataElement()

```
template<uint16_t Group, uint16_t Element, long long TVR>
void gdcM::Attribute< Group, Element, TVR, VM::VM1 >::SetFromDataElement (
    DataElement const & de ) [inline]
```

References `gdcM::DataElement::GetByteValue()`, `gdcM::DataElement::GetTag()`, `gdcM::DataElement::GetVR()`, and `gdcM::DataElement::IsEmpty()`.

### 10.18.3.23 SetFromDataSet()

```
template<uint16_t Group, uint16_t Element, long long TVR>
void gdcM::Attribute< Group, Element, TVR, VM::VM1 >::SetFromDataSet (
    DataSet const & ds ) [inline]
```

References `gdcM::DataSet::FindDataElement()`, and `gdcM::DataSet::GetDataElement()`.

### 10.18.3.24 SetValue()

```
template<uint16_t Group, uint16_t Element, long long TVR>
void gdcM::Attribute< Group, Element, TVR, VM::VM1 >::SetValue (
    ArrayType v ) [inline]
```

## 10.18.4 Member Data Documentation

### 10.18.4.1 Internal

```
template<uint16_t Group, uint16_t Element, long long TVR>
ArrayType gdcM::Attribute< Group, Element, TVR, VM::VM1 >::Internal
```

The documentation for this class was generated from the following file:

- [gdcMAttribute.h](#)

## 10.19 gdcM::Attribute< Group, Element, TVR, VM::VM1\_3 > Class Template Reference

```
#include <gdcMAttribute.h>
```

Inheritance diagram for gdcM::Attribute< Group, Element, TVR, VM::VM1\_3 >:

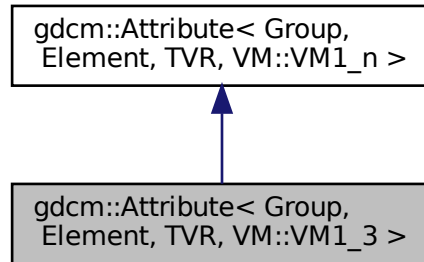

Collaboration diagram for gdcM::Attribute< Group, Element, TVR, VM::VM1\_3 >:

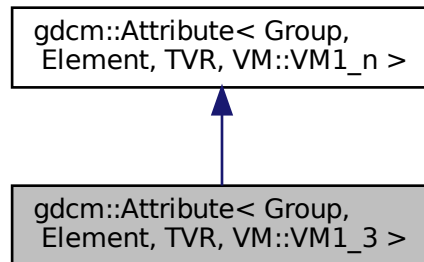

### Public Member Functions

- [VM GetVM](#) () const

### Additional Inherited Members

#### 10.19.1 Member Function Documentation

### 10.19.1.1 GetVM()

```
template<uint16_t Group, uint16_t Element, long long TVR>
VM gdcM::Attribute< Group, Element, TVR, VM::VM1_3 >::GetVM ( ) const [inline]
```

The documentation for this class was generated from the following file:

- [gdcMAttribute.h](#)

## 10.20 gdcM::Attribute< Group, Element, TVR, VM::VM1\_8 > Class Template Reference

```
#include <gdcMAttribute.h>
```

Inheritance diagram for gdcM::Attribute< Group, Element, TVR, VM::VM1\_8 >:

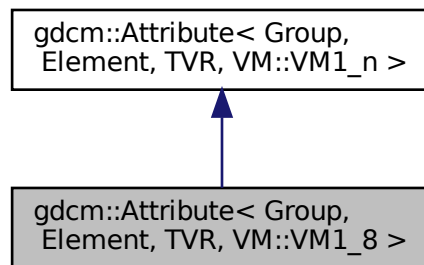

Collaboration diagram for gdcM::Attribute< Group, Element, TVR, VM::VM1\_8 >:

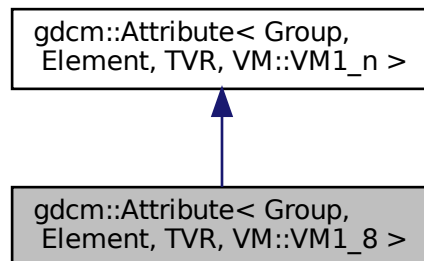

## Public Member Functions

- [VM GetVM \(\)](#) const

## Additional Inherited Members

### 10.20.1 Member Function Documentation

#### 10.20.1.1 GetVM()

```
template<uint16_t Group, uint16_t Element, long long TVR>
VM gdcm::Attribute< Group, Element, TVR, VM::VM1_8 >::GetVM ( ) const [inline]
```

The documentation for this class was generated from the following file:

- [gdcmAttribute.h](#)

## 10.21 gdcm::Attribute< Group, Element, TVR, VM::VM1\_n > Class Template Reference

```
#include <gdcmAttribute.h>
```

Inheritance diagram for gdcm::Attribute< Group, Element, TVR, VM::VM1\_n >:

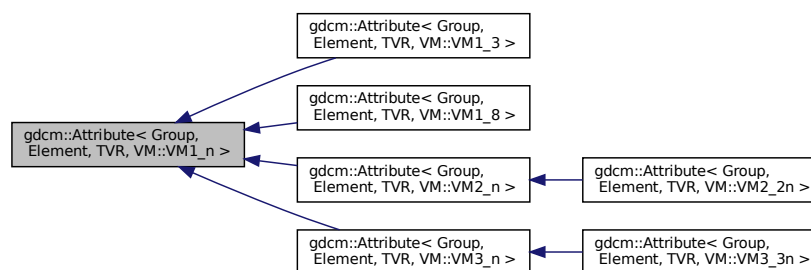

## Public Types

- typedef [VRToType< TVR >::Type ArrayType](#)

## Public Member Functions

- [Attribute](#) ()
- [~Attribute](#) ()
- [GDCM\\_STATIC\\_ASSERT](#) ((((((VR::VRType) TVR &VR::VR\_VM1) &&((VM::VMType) TagToType< Group, [Element](#) >::VMType==VM::VM1))||!((VR::VRType) TVR &VR::VR\_VM1)))
- [GDCM\\_STATIC\\_ASSERT](#) (((VR::VRType) TVR &(VR::VRType)(TagToType< Group, [Element](#) >::VRType)))
- [GDCM\\_STATIC\\_ASSERT](#) ((VM::VM1\_n &(VM::VMType)(TagToType< Group, [Element](#) >::VMType)))
- [DataElement](#) [GetAsDataElement](#) () const
- unsigned int [GetNumberOfValues](#) () const
- [ArrayType](#) & [GetValue](#) (unsigned int idx=0)
- [ArrayType](#) const & [GetValue](#) (unsigned int idx=0) const
- const [ArrayType](#) \* [GetValues](#) () const
- [ArrayType](#) & [operator\[\]](#) (unsigned int idx)
- [ArrayType](#) const & [operator\[\]](#) (unsigned int idx) const
- void [Print](#) (std::ostream &os) const
- void [Set](#) ([DataSet](#) const &ds)
- void [SetFromDataElement](#) ([DataElement](#) const &de)
- void [SetFromDataSet](#) ([DataSet](#) const &ds)
- void [SetNumberOfValues](#) (unsigned int numel)
- void [SetValue](#) ([ArrayType](#) v)
- void [SetValue](#) (unsigned int idx, [ArrayType](#) v)
- void [SetValues](#) (const [ArrayType](#) \*array, unsigned int numel, bool own=false)

## Static Public Member Functions

- static [VM](#) [GetDictVM](#) ()
- static [VR](#) [GetDictVR](#) ()
- static [Tag](#) [GetTag](#) ()
- static [VM](#) [GetVM](#) ()
- static [VR](#) [GetVR](#) ()

## Protected Member Functions

- void [SetByteValue](#) (const [ByteValue](#) \*bv)

### 10.21.1 Member Typedef Documentation

#### 10.21.1.1 ArrayType

```
template<uint16_t Group, uint16_t Element, long long TVR>
typedef VRToType<TVR>::Type gdcM::Attribute< Group, Element, TVR, VM::VM1_n >::ArrayType
```

## 10.21.2 Constructor & Destructor Documentation

### 10.21.2.1 Attribute()

```
template<uint16_t Group, uint16_t Element, long long TVR>
gdcm::Attribute< Group, Element, TVR, VM::VM1_n >::Attribute ( ) [inline], [explicit]
```

### 10.21.2.2 ~Attribute()

```
template<uint16_t Group, uint16_t Element, long long TVR>
gdcm::Attribute< Group, Element, TVR, VM::VM1_n >::~~Attribute ( ) [inline]
```

## 10.21.3 Member Function Documentation

### 10.21.3.1 GDCM\_STATIC\_ASSERT() [1/3]

```
template<uint16_t Group, uint16_t Element, long long TVR>
gdcm::Attribute< Group, Element, TVR, VM::VM1_n >::GDCM_STATIC_ASSERT (
    (((VR::VRType) TVR &VR::VR_VM1) &&((VM::VMType) TagToType< Group, Element >::VMType==VM::VM1))||((VR
TVR &VR::VR_VM1)) )
```

### 10.21.3.2 GDCM\_STATIC\_ASSERT() [2/3]

```
template<uint16_t Group, uint16_t Element, long long TVR>
gdcm::Attribute< Group, Element, TVR, VM::VM1_n >::GDCM_STATIC_ASSERT (
    ((VR::VRType) TVR &(VR::VRType) (TagToType< Group, Element >::VRType)) )
```

### 10.21.3.3 GDCM\_STATIC\_ASSERT() [3/3]

```
template<uint16_t Group, uint16_t Element, long long TVR>
gdcm::Attribute< Group, Element, TVR, VM::VM1_n >::GDCM_STATIC_ASSERT (
    (VM::VM1_n &(VM::VMType) (TagToType< Group, Element >::VMType)) )
```

### 10.21.3.4 GetAsDataElement()

```
template<uint16_t Group, uint16_t Element, long long TVR>
DataElement gdcm::Attribute< Group, Element, TVR, VM::VM1_n >::GetAsDataElement ( ) const [inline]
```

References `gdcm::DataElement::GetVR()`, `gdcm::DataElement::SetByteValue()`, and `gdcm::DataElement::SetVR()`.

### 10.21.3.5 GetDictVM()

```
template<uint16_t Group, uint16_t Element, long long TVR>
static VM gdcm::Attribute< Group, Element, TVR, VM::VM1_n >::GetDictVM ( ) [inline], [static]
```

### 10.21.3.6 GetDictVR()

```
template<uint16_t Group, uint16_t Element, long long TVR>
static VR gdcm::Attribute< Group, Element, TVR, VM::VM1_n >::GetDictVR ( ) [inline], [static]
```

### 10.21.3.7 GetNumberOfValues()

```
template<uint16_t Group, uint16_t Element, long long TVR>
unsigned int gdcm::Attribute< Group, Element, TVR, VM::VM1_n >::GetNumberOfValues ( ) const [inline]
```

### 10.21.3.8 GetTag()

```
template<uint16_t Group, uint16_t Element, long long TVR>
static Tag gdcm::Attribute< Group, Element, TVR, VM::VM1_n >::GetTag ( ) [inline], [static]
```

### 10.21.3.9 GetValue() [1/2]

```
template<uint16_t Group, uint16_t Element, long long TVR>
ArrayType& gdcm::Attribute< Group, Element, TVR, VM::VM1_n >::GetValue (
    unsigned int idx = 0 ) [inline]
```



### 10.21.3.10 GetValue() [2/2]

```
template<uint16_t Group, uint16_t Element, long long TVR>
ArrayType const& gdcm::Attribute< Group, Element, TVR, VM::VM1_n >::GetValue (
    unsigned int idx = 0 ) const [inline]
```

### 10.21.3.11 GetValues()

```
template<uint16_t Group, uint16_t Element, long long TVR>
const ArrayType* gdcm::Attribute< Group, Element, TVR, VM::VM1_n >::GetValues ( ) const [inline]
```

### 10.21.3.12 GetVM()

```
template<uint16_t Group, uint16_t Element, long long TVR>
static VM gdcm::Attribute< Group, Element, TVR, VM::VM1_n >::GetVM ( ) [inline], [static]
```

### 10.21.3.13 GetVR()

```
template<uint16_t Group, uint16_t Element, long long TVR>
static VR gdcm::Attribute< Group, Element, TVR, VM::VM1_n >::GetVR ( ) [inline], [static]
```

### 10.21.3.14 operator[]() [1/2]

```
template<uint16_t Group, uint16_t Element, long long TVR>
ArrayType& gdcm::Attribute< Group, Element, TVR, VM::VM1_n >::operator[] (
    unsigned int idx ) [inline]
```

### 10.21.3.15 operator[]() [2/2]

```
template<uint16_t Group, uint16_t Element, long long TVR>
ArrayType const& gdcm::Attribute< Group, Element, TVR, VM::VM1_n >::operator[] (
    unsigned int idx ) const [inline]
```

### 10.21.3.16 Print()

```
template<uint16_t Group, uint16_t Element, long long TVR>
void gdcM::Attribute< Group, Element, TVR, VM::VM1_n >::Print (
    std::ostream & os ) const [inline]
```

### 10.21.3.17 Set()

```
template<uint16_t Group, uint16_t Element, long long TVR>
void gdcM::Attribute< Group, Element, TVR, VM::VM1_n >::Set (
    DataSet const & ds ) [inline]
```

References `gdcM::DataSet::GetDataElement()`.

### 10.21.3.18 SetByteValue()

```
template<uint16_t Group, uint16_t Element, long long TVR>
void gdcM::Attribute< Group, Element, TVR, VM::VM1_n >::SetByteValue (
    const ByteValue * bv ) [inline], [protected]
```

References `gdcM::ByteValue::GetLength()`, and `gdcM::ByteValue::GetPointer()`.

### 10.21.3.19 SetFromDataElement()

```
template<uint16_t Group, uint16_t Element, long long TVR>
void gdcM::Attribute< Group, Element, TVR, VM::VM1_n >::SetFromDataElement (
    DataElement const & de ) [inline]
```

References `gdcM::DataElement::GetByteValue()`, `gdcM::DataElement::GetTag()`, `gdcM::DataElement::GetVR()`, and `gdcM::DataElement::IsEmpty()`.

### 10.21.3.20 SetFromDataSet()

```
template<uint16_t Group, uint16_t Element, long long TVR>
void gdcM::Attribute< Group, Element, TVR, VM::VM1_n >::SetFromDataSet (
    DataSet const & ds ) [inline]
```

References `gdcM::DataSet::FindDataElement()`, and `gdcM::DataSet::GetDataElement()`.

### 10.21.3.21 SetNumberOfValues()

```
template<uint16_t Group, uint16_t Element, long long TVR>
void gdcM::Attribute< Group, Element, TVR, VM::VM1_n >::SetNumberOfValues (
    unsigned int numel ) [inline]
```

### 10.21.3.22 SetValue() [1/2]

```
template<uint16_t Group, uint16_t Element, long long TVR>
void gdcM::Attribute< Group, Element, TVR, VM::VM1_n >::SetValue (
    ArrayType v ) [inline]
```

References SetValue().

Referenced by SetValue().

### 10.21.3.23 SetValue() [2/2]

```
template<uint16_t Group, uint16_t Element, long long TVR>
void gdcM::Attribute< Group, Element, TVR, VM::VM1_n >::SetValue (
    unsigned int idx,
    ArrayType v ) [inline]
```

### 10.21.3.24 SetValues()

```
template<uint16_t Group, uint16_t Element, long long TVR>
void gdcM::Attribute< Group, Element, TVR, VM::VM1_n >::SetValues (
    const ArrayType * array,
    unsigned int numel,
    bool own = false ) [inline]
```

The documentation for this class was generated from the following file:

- [gdcMAttribute.h](#)

## 10.22 gdcM::Attribute< Group, Element, TVR, VM::VM2\_2n > Class Template Reference

```
#include <gdcMAttribute.h>
```

Inheritance diagram for gdcM::Attribute< Group, Element, TVR, VM::VM2\_2n >:

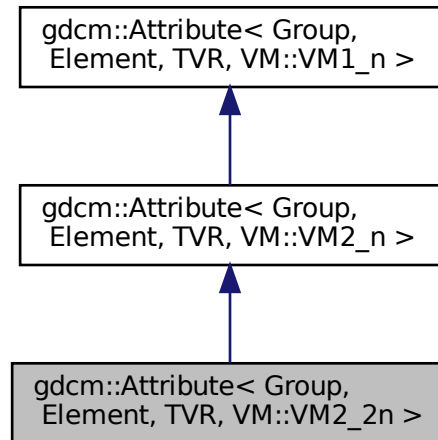

Collaboration diagram for gdcM::Attribute< Group, Element, TVR, VM::VM2\_2n >:

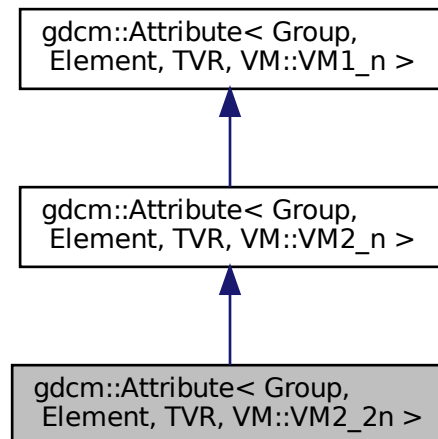

## Static Public Member Functions

- static [VM GetVM \(\)](#)

## Additional Inherited Members

### 10.22.1 Member Function Documentation

#### 10.22.1.1 GetVM()

```
template<uint16_t Group, uint16_t Element, long long TVR>  
static VM gdcM::Attribute< Group, Element, TVR, VM::VM2_2n >::GetVM ( ) [inline], [static]
```

The documentation for this class was generated from the following file:

- [gdcMAttribute.h](#)

## 10.23 gdcM::Attribute< Group, Element, TVR, VM::VM2\_n > Class Template Reference

```
#include <gdcMAttribute.h>
```

Inheritance diagram for gdcM::Attribute< Group, Element, TVR, VM::VM2\_n >:

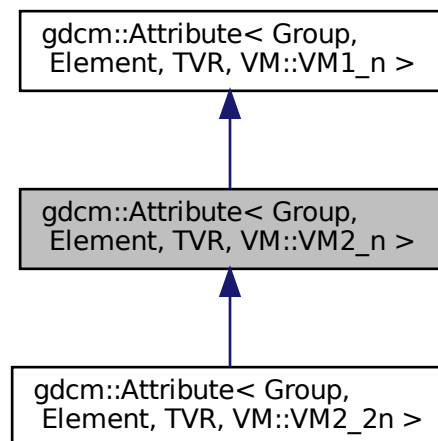

Collaboration diagram for `gdcM::Attribute< Group, Element, TVR, VM::VM2_n >`:

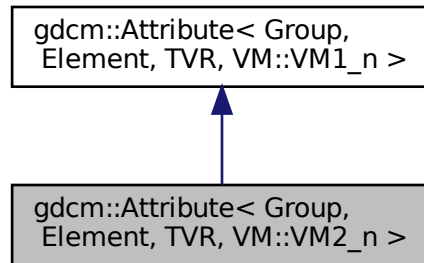

## Public Member Functions

- [VM GetVM](#) () const

## Additional Inherited Members

### 10.23.1 Member Function Documentation

#### 10.23.1.1 GetVM()

```
template<uint16_t Group, uint16_t Element, long long TVR>
VM gdcM::Attribute< Group, Element, TVR, VM::VM2_n >::GetVM ( ) const [inline]
```

The documentation for this class was generated from the following file:

- [gdcMAttribute.h](#)

## 10.24 gdcM::Attribute< Group, Element, TVR, VM::VM3\_3n > Class Template Reference

```
#include <gdcMAttribute.h>
```

Inheritance diagram for gdcM::Attribute< Group, Element, TVR, VM::VM3\_3n >:

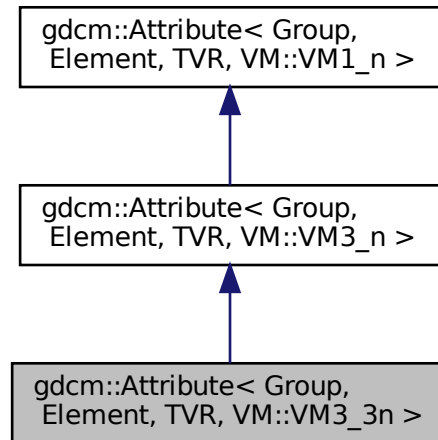

Collaboration diagram for gdcM::Attribute< Group, Element, TVR, VM::VM3\_3n >:

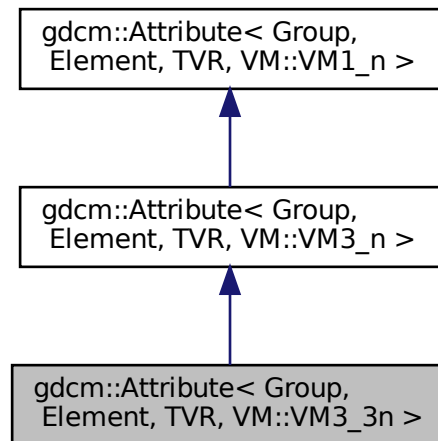

## Static Public Member Functions

- static [VM GetVM](#) ()

## Additional Inherited Members

### 10.24.1 Member Function Documentation

#### 10.24.1.1 GetVM()

```
template<uint16_t Group, uint16_t Element, long long TVR>
static VM gdcM::Attribute< Group, Element, TVR, VM::VM3\_3n >::GetVM ( ) [inline], [static]
```

The documentation for this class was generated from the following file:

- [gdcMAttribute.h](#)

## 10.25 [gdcM::Attribute](#)< Group, Element, TVR, VM::VM3\_n > Class Template Reference

```
#include <gdcMAttribute.h>
```

Inheritance diagram for [gdcM::Attribute](#)< Group, Element, TVR, VM::VM3\_n >:

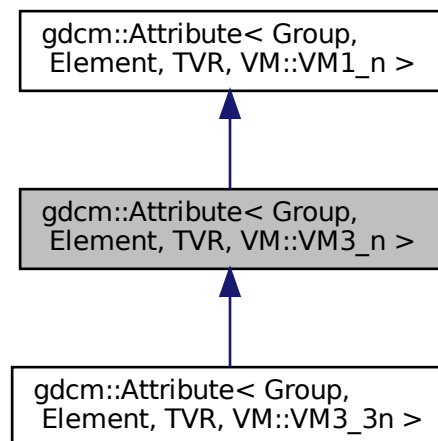



Collaboration diagram for gdcM::Attribute< Group, Element, TVR, VM::VM3\_n >:

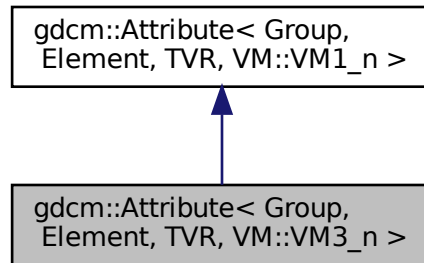

### Static Public Member Functions

- static [VM GetVM](#) ()

### Additional Inherited Members

#### 10.25.1 Member Function Documentation

##### 10.25.1.1 GetVM()

```
template<uint16_t Group, uint16_t Element, long long TVR>
static VM gdcM::Attribute< Group, Element, TVR, VM::VM3_n >::GetVM ( ) [inline], [static]
```

The documentation for this class was generated from the following file:

- [gdcMAttribute.h](#)

## 10.26 gdcM::AudioCodec Class Reference

[AudioCodec](#).

```
#include <gdcMAudioCodec.h>
```

Inheritance diagram for gdcM::AudioCodec:

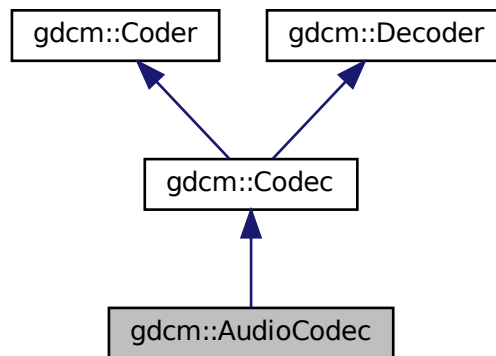

Collaboration diagram for gdcM::AudioCodec:

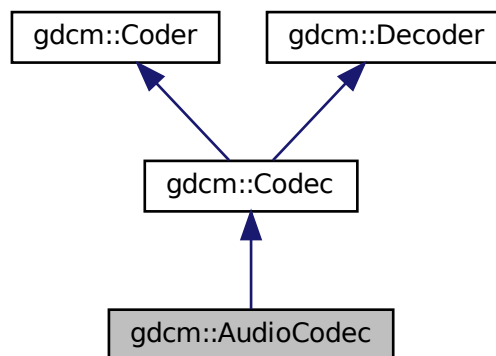

## Public Member Functions

- [AudioCodec](#) ()
- [~AudioCodec](#) () override
- bool [CanCode](#) ([TransferSyntax](#) const &) const override  
*Return whether this coder support this transfer syntax (can code it)*
- bool [CanDecode](#) ([TransferSyntax](#) const &) const override  
*Return whether this decoder support this transfer syntax (can decode it)*
- bool [Decode](#) ([DataElement](#) const &is, [DataElement](#) &os) override  
*Decode.*

## Additional Inherited Members

### 10.26.1 Detailed Description

[AudioCodec](#).

### 10.26.2 Constructor & Destructor Documentation

#### 10.26.2.1 AudioCodec()

```
gdcmm::AudioCodec::AudioCodec ( )
```

#### 10.26.2.2 ~AudioCodec()

```
gdcmm::AudioCodec::~~AudioCodec ( ) [override]
```

### 10.26.3 Member Function Documentation

#### 10.26.3.1 CanCode()

```
bool gdcmm::AudioCodec::CanCode (
    TransferSyntax const & ) const [inline], [override], [virtual]
```

Return whether this coder support this transfer syntax (can code it)

Implements [gdcmm::Coder](#).

### 10.26.3.2 CanDecode()

```
bool gdcM::AudioCodec::CanDecode (
    TransferSyntax const & ) const [inline], [override], [virtual]
```

Return whether this decoder support this transfer syntax (can decode it)

Implements [gdcM::Decoder](#).

### 10.26.3.3 Decode()

```
bool gdcM::AudioCodec::Decode (
    DataElement const & ,
    DataElement & ) [override], [virtual]
```

Decode.

Reimplemented from [gdcM::Decoder](#).

The documentation for this class was generated from the following file:

- [gdcMAudioCodec.h](#)

## 10.27 gdcM::Base64 Class Reference

Class for [Base64](#).

```
#include <gdcMBase64.h>
```

### Public Member Functions

- [Base64](#) (const [Base64](#) &)=delete
- void [operator=](#) (const [Base64](#) &)=delete

### Static Public Member Functions

- static size\_t [Decode](#) (char \*dst, size\_t dlen, const char \*src, size\_t slen)  
*Decode a base64-formatted buffer.*
- static size\_t [Encode](#) (char \*dst, size\_t dlen, const char \*src, size\_t slen)  
*Encode a buffer into base64 format.*
- static size\_t [GetDecodeLength](#) (const char \*src, size\_t len)
- static size\_t [GetEncodeLength](#) (const char \*src, size\_t srclen)

## 10.27.1 Detailed Description

Class for [Base64](#).

## 10.27.2 Constructor & Destructor Documentation

### 10.27.2.1 Base64()

```
gdcmm::Base64::Base64 (
    const Base64 & ) [delete]
```

## 10.27.3 Member Function Documentation

### 10.27.3.1 Decode()

```
static size_t gdcmm::Base64::Decode (
    char * dst,
    size_t dlen,
    const char * src,
    size_t slen ) [static]
```

Decode a base64-formatted buffer.

#### Parameters

<i>dst</i>	destination buffer
<i>dlen</i>	size of the buffer
<i>src</i>	source buffer
<i>slen</i>	amount of data to be decoded

#### Returns

0 if not successful, size of decoded otherwise

#### Examples

[DumpExamCard.cxx](#), and [DumpSiemensBase64.cxx](#).

### 10.27.3.2 Encode()

```
static size_t gdcM::Base64::Encode (
    char * dst,
    size_t dlen,
    const char * src,
    size_t slen ) [static]
```

Encode a buffer into base64 format.

#### Parameters

<i>dst</i>	destination buffer
<i>dlen</i>	size of the buffer
<i>src</i>	source buffer
<i>slen</i>	amount of data to be encoded

#### Returns

0 if not successful, size of encoded otherwise

### 10.27.3.3 GetDecodeLength()

```
static size_t gdcM::Base64::GetDecodeLength (
    const char * src,
    size_t len ) [static]
```

Call this function to obtain the required buffer size

#### Examples

[DumpExamCard.cxx](#), and [DumpSiemensBase64.cxx](#).

### 10.27.3.4 GetEncodeLength()

```
static size_t gdcM::Base64::GetEncodeLength (
    const char * src,
    size_t srclen ) [static]
```

Call this function to obtain the required buffer size

### 10.27.3.5 operator=()

```
void gdcm::Base64::operator= (
    const Base64 & ) [delete]
```

The documentation for this class was generated from the following file:

- [gdcmBase64.h](#)

## 10.28 gdcm::network::BaseCompositeMessage Class Reference

[BaseCompositeMessage](#).

```
#include <gdcmBaseCompositeMessage.h>
```

Inheritance diagram for gdcm::network::BaseCompositeMessage:

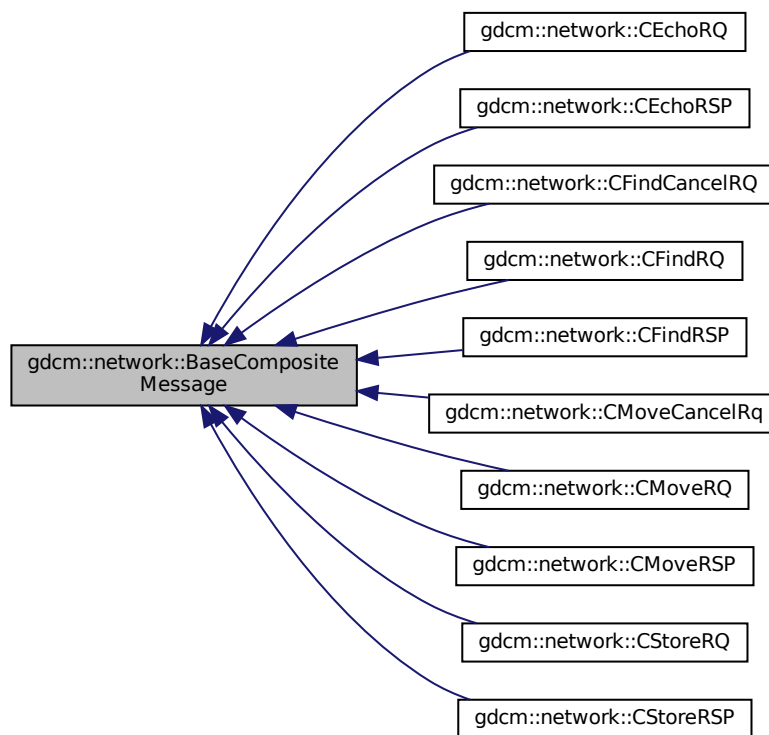

### Public Member Functions

- virtual [~BaseCompositeMessage](#) ()=default
- virtual std::vector< [PresentationDataValue](#) > [ConstructPDV](#) (const [ULConnection](#) &inConnection, const [BaseRootQuery](#) \*inRootQuery)=0

## 10.28.1 Detailed Description

### [BaseCompositeMessage](#).

The Composite events described in section 3.7-2009 of the DICOM standard all use their own messages. These messages are constructed using Presentation Data Values, from section 3.8-2009 of the standard, and then fill in appropriate values in their datasets.

So, for the five composites:

- C-ECHO
- C-FIND
- C-MOVE
- C-GET
- C-STORE there are a series of messages. However, all of these messages are obtained as part of a PDataPDU, and all have to be placed there. Therefore, since they all have shared functionality and construction tropes, that will be put into a base class. Further, the base class will be then returned by the factory class, `gdcmCompositePDUFactory`.

This is an abstract class. It cannot be instantiated on its own.

## 10.28.2 Constructor & Destructor Documentation

### 10.28.2.1 `~BaseCompositeMessage()`

```
virtual gdcm::network::BaseCompositeMessage::~BaseCompositeMessage ( ) [virtual], [default]
```

## 10.28.3 Member Function Documentation

### 10.28.3.1 `ConstructPDV()`

```
virtual std::vector<PresentationDataValue> gdcm::network::BaseCompositeMessage::ConstructPDV (
    const ULConnection & inConnection,
    const BaseRootQuery * inRootQuery ) [pure virtual]
```

Implemented in [gdcm::network::CMoveRQ](#), [gdcm::network::CFindRQ](#), and [gdcm::network::CEchoRQ](#).

The documentation for this class was generated from the following file:

- [gdcmBaseCompositeMessage.h](#)



## 10.29 gdcM::network::BaseNormalizedMessage Class Reference

[BaseNormalizedMessage](#).

```
#include <gdcMBaseNormalizedMessage.h>
```

Inheritance diagram for gdcM::network::BaseNormalizedMessage:

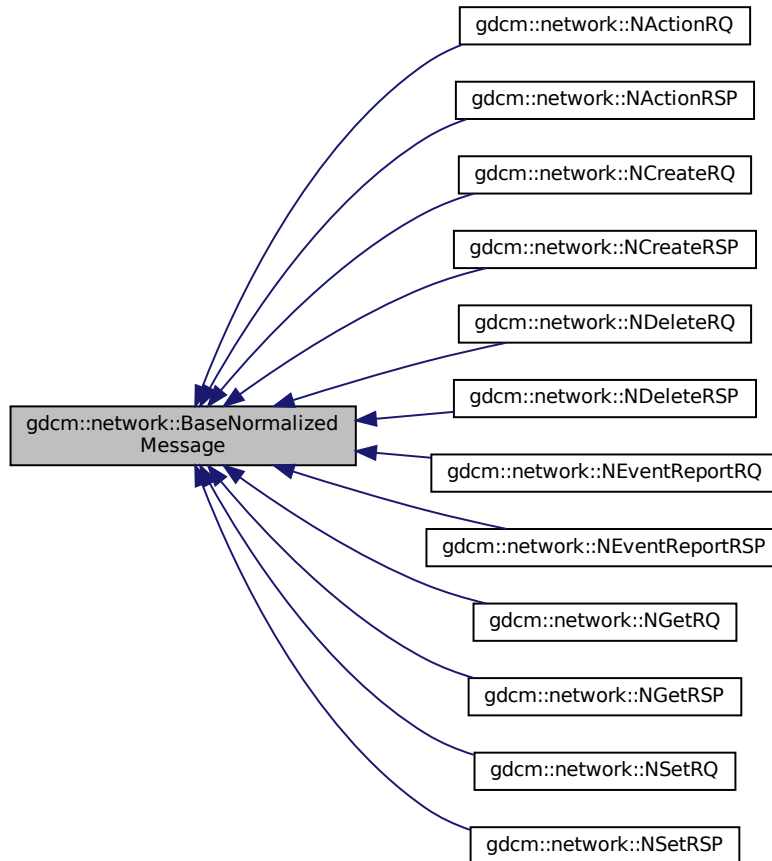

### Public Member Functions

- virtual `~BaseNormalizedMessage()`=default
- virtual `std::vector< PresentationDataValue > ConstructPDV` (const `ULConnection` &inConnection, const `BaseQuery` \*inQuery)=0

## 10.29.1 Detailed Description

### [BaseNormalizedMessage.](#)

The Normalized events described in section 3.7-2011 of the DICOM standard all use their own messages. These messages are constructed using Presentation Data Values, from section 3.8-2011 of the standard, and then fill in appropriate values in their datasets.

So, for the five normalized:

- N-ACTION
- N-CREATE
- N-DELETE
- N-EVENT
- N-GET
- N-SET there are a series of messages. However, all of these messages are obtained as part of a PData↔ PDU, and all have to be placed there. Therefore, since they all have shared functionality and construction tropes, that will be put into a base class. Further, the base class will be then returned by the factory class, [gdcmNormalizedMessageFactory.h](#).

This is an abstract class. It cannot be instantiated on its own.

## 10.29.2 Constructor & Destructor Documentation

### 10.29.2.1 [~BaseNormalizedMessage\(\)](#)

```
virtual gdcm::network::BaseNormalizedMessage::~BaseNormalizedMessage ( ) [virtual], [default]
```

## 10.29.3 Member Function Documentation

### 10.29.3.1 [ConstructPDV\(\)](#)

```
virtual std::vector<PresentationDataValue> gdcm::network::BaseNormalizedMessage::ConstructPDV (
    const ULConnection & inConnection,
    const BaseQuery * inQuery ) [pure virtual]
```

Implemented in [gdcm::network::NSetRQ](#), [gdcm::network::NGetRQ](#), [gdcm::network::NEventReportRQ](#), [gdcm::network::NDeleteRQ](#), [gdcm::network::NCreateRQ](#), and [gdcm::network::NActionRQ](#).

The documentation for this class was generated from the following file:

- [gdcmBaseNormalizedMessage.h](#)

## 10.30 gdcmm::network::BasePDU Class Reference

[BasePDU](#).

```
#include <gdcmmBasePDU.h>
```

Inheritance diagram for gdcmm::network::BasePDU:

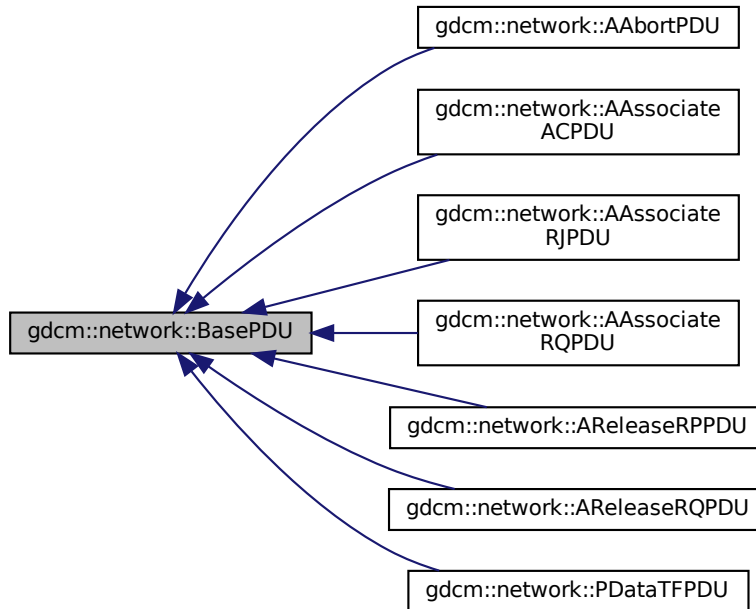

### Public Member Functions

- virtual `~BasePDU()`=default
- virtual bool `IsLastFragment()` const =0
- virtual void `Print(std::ostream &os)` const =0
- virtual `std::istream &Read(std::istream &is)`=0
- virtual `size_t Size()` const =0
- virtual const `std::ostream &Write(std::ostream &os)` const =0

### 10.30.1 Detailed Description

[BasePDU](#).

base class for PDUs

all PDUs start with the first ten bytes as specified: 01 PDU type 02 reserved 3-6 PDU Length (unsigned) 7-10 variable

on some, 7-10 are split (7-8 as protocol version in Associate-RQ, for instance, while associate-rj splits those four bytes differently).

Also common to all the PDUs is their ability to read and write to a stream.

So, let's just get them all bunched together into one (abstract) class, shall we?

Why? 1) so that the [ULEvent](#) can have the PDU stored in it, since the event takes PDUs and not other class structures (other class structures get converted into PDUs) 2) to make reading PDUs in the event loop cleaner

## 10.30.2 Constructor & Destructor Documentation

### 10.30.2.1 ~BasePDU()

```
virtual gdc::network::BasePDU::~BasePDU ( ) [virtual], [default]
```

## 10.30.3 Member Function Documentation

### 10.30.3.1 IsLastFragment()

```
virtual bool gdc::network::BasePDU::IsLastFragment ( ) const [pure virtual]
```

Implemented in [gdc::network::PDataTFPDU](#), [gdc::network::AReleaseRQPDU](#), [gdc::network::AReleaseRPPDU](#), [gdc::network::AAssociateRQPDU](#), [gdc::network::AAssociateRJPDU](#), [gdc::network::AAssociateACPDU](#), and [gdc::network::AAabortPDU](#).

### 10.30.3.2 Print()

```
virtual void gdc::network::BasePDU::Print (
    std::ostream & os ) const [pure virtual]
```

Implemented in [gdc::network::PDataTFPDU](#), [gdc::network::AReleaseRQPDU](#), [gdc::network::AReleaseRPPDU](#), [gdc::network::AAssociateRQPDU](#), [gdc::network::AAssociateRJPDU](#), [gdc::network::AAssociateACPDU](#), and [gdc::network::AAabortPDU](#).

### 10.30.3.3 Read()

```
virtual std::istream& gdcm::network::BasePDU::Read (
    std::istream & is ) [pure virtual]
```

Implemented in [gdcm::network::PDataTFPDU](#), [gdcm::network::AReleaseRQPDU](#), [gdcm::network::AReleaseRPPDU](#), [gdcm::network::AAssociateRQPDU](#), [gdcm::network::AAssociateRJPDU](#), [gdcm::network::AAssociateACPDU](#), and [gdcm::network::AAbortPDU](#).

### 10.30.3.4 Size()

```
virtual size_t gdcm::network::BasePDU::Size ( ) const [pure virtual]
```

Implemented in [gdcm::network::PDataTFPDU](#), [gdcm::network::AReleaseRQPDU](#), [gdcm::network::AReleaseRPPDU](#), [gdcm::network::AAssociateRQPDU](#), [gdcm::network::AAssociateRJPDU](#), [gdcm::network::AAssociateACPDU](#), and [gdcm::network::AAbortPDU](#).

### 10.30.3.5 Write()

```
virtual const std::ostream& gdcm::network::BasePDU::Write (
    std::ostream & os ) const [pure virtual]
```

Implemented in [gdcm::network::PDataTFPDU](#), [gdcm::network::AReleaseRQPDU](#), [gdcm::network::AReleaseRPPDU](#), [gdcm::network::AAssociateRQPDU](#), [gdcm::network::AAssociateRJPDU](#), [gdcm::network::AAssociateACPDU](#), and [gdcm::network::AAbortPDU](#).

The documentation for this class was generated from the following file:

- [gdcmBasePDU.h](#)

## 10.31 gdcm::BaseQuery Class Reference

[BaseQuery](#).

```
#include <gdcmBaseQuery.h>
```

Inheritance diagram for `gdcm::BaseQuery`:

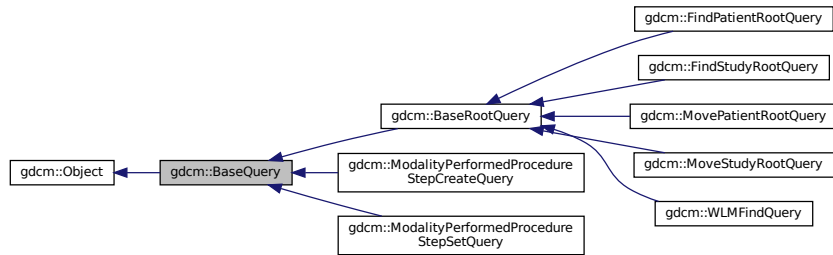

Collaboration diagram for `gdcm::BaseQuery`:

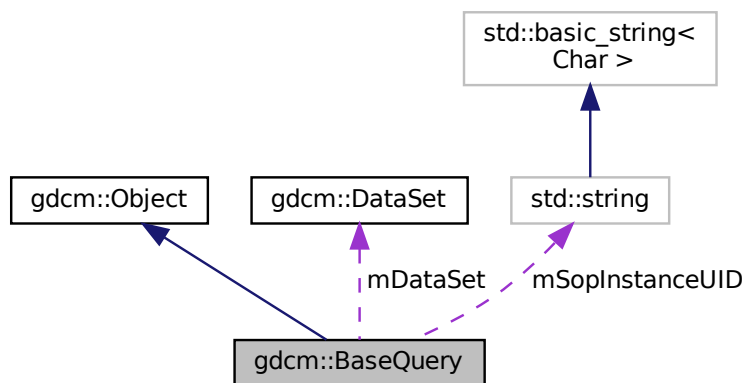

## Public Member Functions

- `~BaseQuery` () override
- void `AddQueryDataSet` (const `DataSet` &ds)
- virtual `UIDs::TSName GetAbstractSyntaxUID` () const =0
- `DataSet` & `GetQueryDataSet` ()
- `DataSet` const & `GetQueryDataSet` () const
- *Set/Get the internal representation of the query as a `DataSet`.*
- `std::string GetSOPInstanceUID` () const
- void `Print` (`std::ostream` &os) const override
- void `SetSearchParameter` (const `std::string` &inKeyword, const `std::string` &inValue)
- void `SetSearchParameter` (const `Tag` &inTag, const `std::string` &inValue)
- void `SetSOPInstanceUID` (const `std::string` &iSopInstanceUID)
- virtual bool `ValidateQuery` (bool inStrict=true) const =0
- const `std::ostream` & `WriteHelpFile` (`std::ostream` &os)
- bool `WriteQuery` (const `std::string` &inFileName)

## Protected Member Functions

- [BaseQuery](#) ()
- void [SetSearchParameter](#) (const [Tag](#) &inTag, const [DictEntry](#) &inDictEntry, const std::string &inValue)
- bool [ValidDataSet](#) (const [DataSet](#) &dataSetToValid, const [DataSet](#) &dataSetReference) const

## Protected Attributes

- [DataSet](#) [mDataSet](#)
- std::string [mSopInstanceUID](#)

## Friends

- class [QueryFactory](#)

### 10.31.1 Detailed Description

[BaseQuery](#).

contains: a baseclass which will produce a dataset for all dimse messages

### 10.31.2 Constructor & Destructor Documentation

#### 10.31.2.1 BaseQuery()

```
gdcm::BaseQuery::BaseQuery ( ) [protected]
```

#### 10.31.2.2 ~BaseQuery()

```
gdcm::BaseQuery::~~BaseQuery ( ) [override]
```

### 10.31.3 Member Function Documentation

### 10.31.3.1 AddQueryDataSet()

```
void gdcM::BaseQuery::AddQueryDataSet (
    const DataSet & ds )
```

### 10.31.3.2 GetAbstractSyntaxUID()

```
virtual UIDs::TSName gdcM::BaseQuery::GetAbstractSyntaxUID ( ) const [pure virtual]
```

Implemented in [gdcM::WLMFindQuery](#), [gdcM::MoveStudyRootQuery](#), [gdcM::MovePatientRootQuery](#), [gdcM::ModalityPerformedProcedureStepCreateQuery](#), [gdcM::FindStudyRootQuery](#), and [gdcM::FindPatientRootQuery](#).

### 10.31.3.3 GetQueryDataSet() [1/2]

```
DataSet& gdcM::BaseQuery::GetQueryDataSet ( )
```

### 10.31.3.4 GetQueryDataSet() [2/2]

```
DataSet const& gdcM::BaseQuery::GetQueryDataSet ( ) const
```

Set/Get the internal representation of the query as a [DataSet](#).

### 10.31.3.5 GetSOPInstanceUID()

```
std::string gdcM::BaseQuery::GetSOPInstanceUID ( ) const [inline]
```

### 10.31.3.6 Print()

```
void gdcM::BaseQuery::Print (
    std::ostream & os ) const [override], [virtual]
```

Reimplemented from [gdcM::Object](#).



### 10.31.3.7 SetSearchParameter() [1/3]

```
void gdcm::BaseQuery::SetSearchParameter (
    const std::string & inKeyword,
    const std::string & inValue )
```

### 10.31.3.8 SetSearchParameter() [2/3]

```
void gdcm::BaseQuery::SetSearchParameter (
    const Tag & inTag,
    const DictEntry & inDictEntry,
    const std::string & inValue ) [protected]
```

### 10.31.3.9 SetSearchParameter() [3/3]

```
void gdcm::BaseQuery::SetSearchParameter (
    const Tag & inTag,
    const std::string & inValue )
```

### 10.31.3.10 SetSOPInstanceUID()

```
void gdcm::BaseQuery::SetSOPInstanceUID (
    const std::string & iSopInstanceUID ) [inline]
```

### 10.31.3.11 ValidateQuery()

```
virtual bool gdcm::BaseQuery::ValidateQuery (
    bool inStrict = true ) const [pure virtual]
```

Implemented in [gdcm::BaseRootQuery](#), [gdcm::WLMFindQuery](#), [gdcm::MoveStudyRootQuery](#), [gdcm::MovePatientRootQuery](#), [gdcm::ModalityPerformedProcedureStepSetQuery](#), [gdcm::ModalityPerformedProcedureStepCreateQuery](#), [gdcm::FindStudyRootQuery](#), and [gdcm::FindPatientRootQuery](#).

### 10.31.3.12 ValidDataSet()

```
bool gdcM::BaseQuery::ValidDataSet (
    const DataSet & dataSetToValid,
    const DataSet & dataSetReference ) const [protected]
```

### 10.31.3.13 WriteHelpFile()

```
const std::ostream& gdcM::BaseQuery::WriteHelpFile (
    std::ostream & os )
```

### 10.31.3.14 WriteQuery()

```
bool gdcM::BaseQuery::WriteQuery (
    const std::string & inFileName )
```

## 10.31.4 Friends And Related Function Documentation

### 10.31.4.1 QueryFactory

```
friend class QueryFactory [friend]
```

## 10.31.5 Member Data Documentation

### 10.31.5.1 mDataSet

```
DataSet gdcM::BaseQuery::mDataSet [protected]
```

## 10.31.5.2 mSopInstanceUID

```
std::string gdcm::BaseQuery::mSopInstanceUID [protected]
```

The documentation for this class was generated from the following file:

- [gdcmBaseQuery.h](#)

## 10.32 gdcm::BaseRootQuery Class Reference

[BaseRootQuery](#).

```
#include <gdcmBaseRootQuery.h>
```

Inheritance diagram for gdcm::BaseRootQuery:

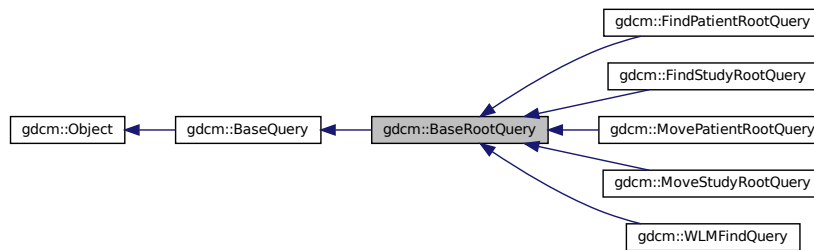

Collaboration diagram for gdcm::BaseRootQuery:

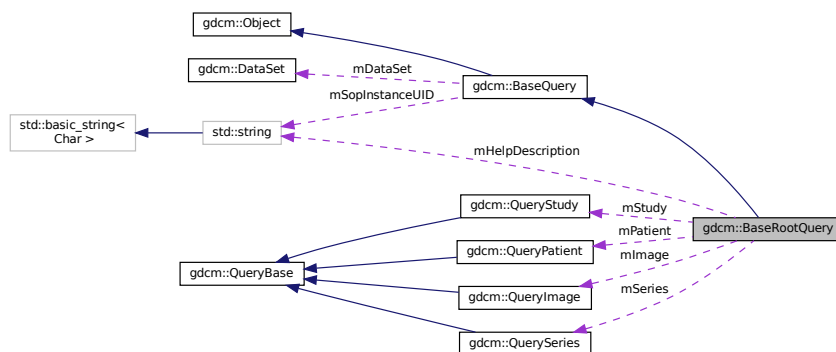

## Public Member Functions

- [~BaseRootQuery](#) () override
- [EQueryLevel](#) [GetQueryLevelFromQueryRoot](#) ([ERootType](#) rootype)
- virtual `std::vector< Tag >` [GetTagListByLevel](#) (const [EQueryLevel](#) &inQueryLevel)=0
- virtual void [InitializeDataSet](#) (const [EQueryLevel](#) &inQueryLevel)=0
- bool [ValidateQuery](#) (bool inStrict=true) const override=0

## Static Public Member Functions

- static [QueryBase](#) \* [Construct](#) ([ERootType](#) inRootType, [EQueryLevel](#) qllevel)
- static int [GetQueryLevelFromString](#) (const char \*str)
- static const char \* [GetQueryLevelString](#) ([EQueryLevel](#) ql)

## Protected Member Functions

- [BaseRootQuery](#) ()

## Protected Attributes

- `std::string` [mHelpDescription](#)
- [QueryImage](#) [mImage](#)
- [QueryPatient](#) [mPatient](#)
- [ERootType](#) [mRootType](#)
- [QuerySeries](#) [mSeries](#)
- [QueryStudy](#) [mStudy](#)

## Friends

- class [QueryFactory](#)

### 10.32.1 Detailed Description

[BaseRootQuery](#).

contains: a baseclass which will produce a dataset for c-find and c-move with patient/study root

This class contains the functionality used in patient c-find and c-move queries. [PatientRootQuery](#) and [StudyRootQuery](#) derive from this class.

Namely: 1) list all tags associated with a particular query type 2) produce a query dataset via tag association

Eventually, it can be used to validate a particular dataset type.

The dataset held by this object (or, really, one of its derivatives) should be passed to a c-find or c-move query.

## 10.32.2 Constructor & Destructor Documentation

### 10.32.2.1 BaseRootQuery()

```
gdcm::BaseRootQuery::BaseRootQuery ( ) [protected]
```

### 10.32.2.2 ~BaseRootQuery()

```
gdcm::BaseRootQuery::~~BaseRootQuery ( ) [override]
```

## 10.32.3 Member Function Documentation

### 10.32.3.1 Construct()

```
static QueryBase* gdcm::BaseRootQuery::Construct (
    ERootType inRootType,
    EQueryLevel qllevel ) [static]
```

### 10.32.3.2 GetQueryLevelFromQueryRoot()

```
EQueryLevel gdcm::BaseRootQuery::GetQueryLevelFromQueryRoot (
    ERootType roottype )
```

### 10.32.3.3 GetQueryLevelFromString()

```
static int gdcm::BaseRootQuery::GetQueryLevelFromString (
    const char * str ) [static]
```

#### 10.32.3.4 GetQueryLevelString()

```
static const char* gdcM::BaseRootQuery::GetQueryLevelString (
    EQueryLevel ql ) [static]
```

#### 10.32.3.5 GetTagListByLevel()

```
virtual std::vector<Tag> gdcM::BaseRootQuery::GetTagListByLevel (
    const EQueryLevel & inQueryLevel ) [pure virtual]
```

this function will return all tags at a given query level, so that they maybe selected for searching. The boolean forFind is true if the query is a find query, or false for a move query.

Implemented in [gdcM::WLMFindQuery](#), [gdcM::MoveStudyRootQuery](#), [gdcM::MovePatientRootQuery](#), [gdcM::FindStudyRootQuery](#), and [gdcM::FindPatientRootQuery](#).

#### 10.32.3.6 InitializeDataSet()

```
virtual void gdcM::BaseRootQuery::InitializeDataSet (
    const EQueryLevel & inQueryLevel ) [pure virtual]
```

this function sets tag 8,52 to the appropriate value based on query level also fills in the right unique tags, as per the standard's requirements should allow for connection with dcmTk

Implemented in [gdcM::WLMFindQuery](#), [gdcM::MoveStudyRootQuery](#), [gdcM::MovePatientRootQuery](#), [gdcM::FindStudyRootQuery](#), and [gdcM::FindPatientRootQuery](#).

#### 10.32.3.7 ValidateQuery()

```
bool gdcM::BaseRootQuery::ValidateQuery (
    bool inStrict = true ) const [override], [pure virtual]
```

have to be able to ensure that 0x8,0x52 is set (which will be true if InitializeDataSet is called...) that the level is appropriate (ie, not setting PATIENT for a study query that the tags in the query match the right level (either required, unique, optional) by default, this function checks to see if the query is for finding, which is more permissive than for moving. For moving, only the unique tags are allowed. 10 Jan 2011: adding in the 'strict' mode. according to the standard (at least, how I've read it), only tags for a particular level should be allowed in a particular query (ie, just series level tags in a series level query). However, it seems that dcm4chee doesn't share that interpretation. So, if 'inStrict' is false, then tags from the current level and all higher levels are now considered valid. So, if you're doing a non-strict series-level query, tags from the patient and study level can be passed along as well.

Implements [gdcM::BaseQuery](#).

Implemented in [gdcM::WLMFindQuery](#), [gdcM::MoveStudyRootQuery](#), [gdcM::MovePatientRootQuery](#), [gdcM::FindStudyRootQuery](#), and [gdcM::FindPatientRootQuery](#).

## 10.32.4 Friends And Related Function Documentation

### 10.32.4.1 QueryFactory

friend class [QueryFactory](#) [friend]

## 10.32.5 Member Data Documentation

### 10.32.5.1 mHelpDescription

std::string gdcm::BaseRootQuery::mHelpDescription [protected]

### 10.32.5.2 mImage

[QueryImage](#) gdcm::BaseRootQuery::mImage [protected]

### 10.32.5.3 mPatient

[QueryPatient](#) gdcm::BaseRootQuery::mPatient [protected]

### 10.32.5.4 mRootType

[ERootType](#) gdcm::BaseRootQuery::mRootType [protected]

### 10.32.5.5 mSeries

[QuerySeries](#) gdcm::BaseRootQuery::mSeries [protected]

### 10.32.5.6 mStudy

`QueryStudy` `gdcm::BaseRootQuery::mStudy` [protected]

The documentation for this class was generated from the following file:

- [gdcmBaseRootQuery.h](#)

## 10.33 gdcm::SegmentHelper::BasicCodedEntry Struct Reference

This structure defines a basic coded entry with all of its attributes.

```
#include <gdcmSegmentHelper.h>
```

Collaboration diagram for `gdcm::SegmentHelper::BasicCodedEntry`:

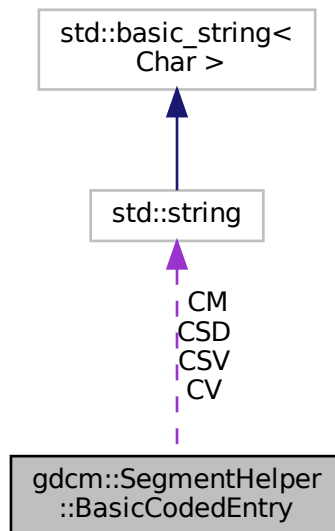

### Public Member Functions

- [BasicCodedEntry](#) ()  
*Constructor.*
- [BasicCodedEntry](#) (const char \*a\_CV, const char \*a\_CSD, const char \*a\_CM)  
*constructor which defines type 1 attributes.*
- [BasicCodedEntry](#) (const char \*a\_CV, const char \*a\_CSD, const char \*a\_CSV, const char \*a\_CM)  
*constructor which defines attributes.*
- bool [IsEmpty](#) (const bool checkOptionalAttributes=false) const  
*Check if each attributes of the basic coded entry is defined.*



## Public Attributes

- std::string [CM](#)  
*Coding Scheme [Version](#) attribute.*
- std::string [CSD](#)  
*Code [Value](#) attribute.*
- std::string [CSV](#)  
*Coding Scheme [Designator](#) attribute.*
- std::string [CV](#)

### 10.33.1 Detailed Description

This structure defines a basic coded entry with all of its attributes.

See also

PS 3.3 section 8.8.

### 10.33.2 Constructor & Destructor Documentation

#### 10.33.2.1 BasicCodedEntry() [1/3]

```
gdcm::SegmentHelper::BasicCodedEntry::BasicCodedEntry ( ) [inline]
```

Constructor.

#### 10.33.2.2 BasicCodedEntry() [2/3]

```
gdcm::SegmentHelper::BasicCodedEntry::BasicCodedEntry (
    const char * a_CV,
    const char * a_CSD,
    const char * a_CM ) [inline]
```

constructor which defines type 1 attributes.

### 10.33.2.3 BasicCodedEntry() [3/3]

```
gdcM::SegmentHelper::BasicCodedEntry::BasicCodedEntry (
    const char * a_CV,
    const char * a_CSD,
    const char * a_CSV,
    const char * a_CM ) [inline]
```

constructor which defines attributes.

## 10.33.3 Member Function Documentation

### 10.33.3.1 IsEmpty()

```
bool gdcM::SegmentHelper::BasicCodedEntry::IsEmpty (
    const bool checkOptionalAttributes = false ) const
```

Check if each attributes of the basic coded entry is defined.

#### Parameters

<i>checkOptionalAttributes</i>	Check also type 1C attributes.
--------------------------------	--------------------------------

## 10.33.4 Member Data Documentation

### 10.33.4.1 CM

```
std::string gdcM::SegmentHelper::BasicCodedEntry::CM
```

Coding Scheme [Version](#) attribute.

### 10.33.4.2 CSD

```
std::string gdcM::SegmentHelper::BasicCodedEntry::CSD
```

Code [Value](#) attribute.

### 10.33.4.3 CSV

```
std::string gdcM::SegmentHelper::BasicCodedEntry::CSV
```

Coding Scheme Designator attribute.

### 10.33.4.4 CV

```
std::string gdcM::SegmentHelper::BasicCodedEntry::CV
```

The documentation for this struct was generated from the following file:

- [gdcMSegmentHelper.h](#)

## 10.34 gdcM::BasicOffsetTable Class Reference

Class to represent a [BasicOffsetTable](#).

```
#include <gdcMBasicOffsetTable.h>
```

Inheritance diagram for gdcM::BasicOffsetTable:

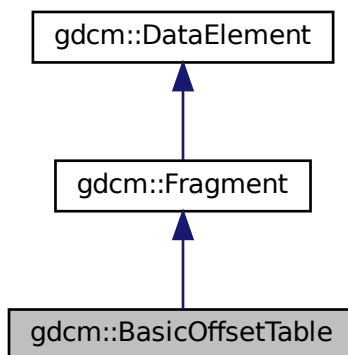

Collaboration diagram for `gdcM::BasicOffsetTable`:

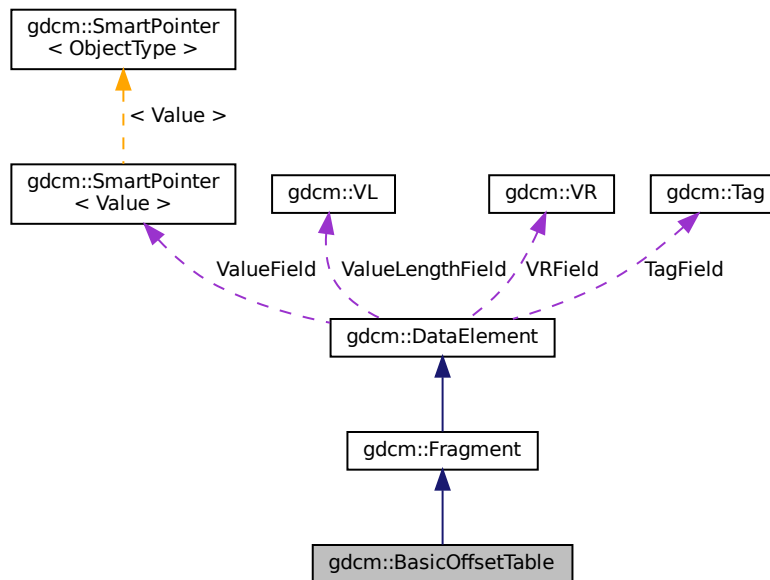

## Public Member Functions

- [BasicOffsetTable](#) ()
- `template<typename TSwap >`  
`std::istream & Read (std::istream &is)`

## Friends

- `std::ostream & operator<< (std::ostream &os, const BasicOffsetTable &val)`

## Additional Inherited Members

### 10.34.1 Detailed Description

Class to represent a [BasicOffsetTable](#).

### 10.34.2 Constructor & Destructor Documentation

### 10.34.2.1 BasicOffsetTable()

```
gdcm::BasicOffsetTable::BasicOffsetTable ( ) [inline]
```

## 10.34.3 Member Function Documentation

### 10.34.3.1 Read()

```
template<typename TSwap >  
std::istream& gdcm::BasicOffsetTable::Read (  
    std::istream & is ) [inline]
```

References `gdcmAssertAlwaysMacro`, and `gdcm::ParseException::SetLastElement()`.

## 10.34.4 Friends And Related Function Documentation

### 10.34.4.1 operator<<

```
std::ostream& operator<< (  
    std::ostream & os,  
    const BasicOffsetTable & val ) [friend]
```

The documentation for this class was generated from the following file:

- [gdcmBasicOffsetTable.h](#)

## 10.35 gdcm::Bitmap Class Reference

[Bitmap](#) class.

```
#include <gdcmBitmap.h>
```

Inheritance diagram for gdcm::Bitmap:

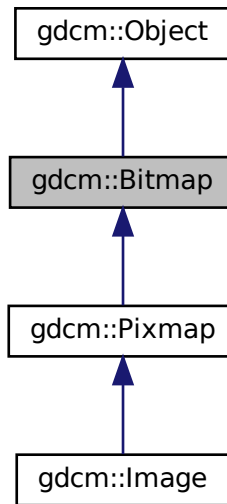

Collaboration diagram for gdcm::Bitmap:

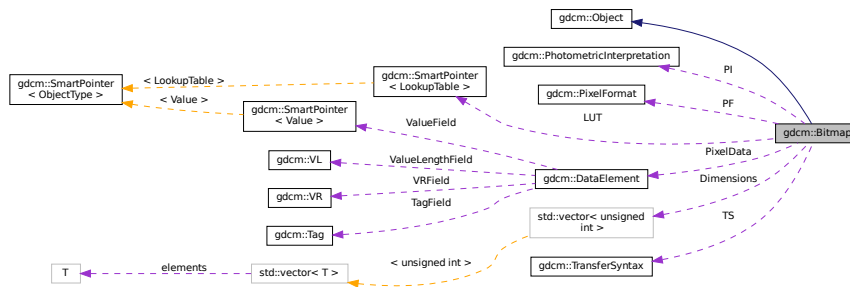

### Public Member Functions

- [Bitmap](#) ()

- [~Bitmap](#) () override
- virtual bool [AreOverlaysInPixelData](#) () const
- void [Clear](#) ()
- bool [GetBuffer](#) (char \*buffer) const  
*Access the raw data.*
- unsigned long [GetBufferLength](#) () const
- unsigned int [GetColumns](#) () const
- [DataElement](#) & [GetDataElement](#) ()
- const [DataElement](#) & [GetDataElement](#) () const
- unsigned int [GetDimension](#) (unsigned int idx) const
- const unsigned int \* [GetDimensions](#) () const  
*Return the dimension of the pixel data, first dimension (x), then 2nd (y), then 3rd (z)...*
- [LookupTable](#) & [GetLUT](#) ()
- const [LookupTable](#) & [GetLUT](#) () const
- bool [GetNeedByteSwap](#) () const  
*INTERNAL do not use.*
- unsigned int [GetNumberOfDimensions](#) () const  
*Return the number of dimension of the pixel data bytes; for example 2 for a 2D matrices of values.*
- const [PhotometricInterpretation](#) & [GetPhotometricInterpretation](#) () const  
*return the photometric interpretation*
- [PixelFormat](#) & [GetPixelFormat](#) ()
- const [PixelFormat](#) & [GetPixelFormat](#) () const  
*Get/Set PixelFormat.*
- unsigned int [GetPlanarConfiguration](#) () const  
*return the planar configuration*
- unsigned int [GetRows](#) () const
- const [TransferSyntax](#) & [GetTransferSyntax](#) () const
- bool [IsEmpty](#) () const
- bool [IsLossy](#) () const  
*Return whether or not the image was compressed using a lossy compressor or not.*
- bool [IsTransferSyntaxCompatible](#) ([TransferSyntax](#) const &ts) const
- void [Print](#) (std::ostream &) const override
- void [SetColumns](#) (unsigned int col)
- void [SetDataElement](#) ([DataElement](#) const &de)
- void [SetDimension](#) (unsigned int idx, unsigned int dim)
- void [SetDimensions](#) (const unsigned int dims[3])
- void [SetLossyFlag](#) (bool f)  
*Specifically set that the image was compressed using a lossy compression mechanism.*
- void [SetLUT](#) ([LookupTable](#) const &lut)  
*Set/Get LUT.*
- void [SetNeedByteSwap](#) (bool b)
- void [SetNumberOfDimensions](#) (unsigned int dim)
- void [SetPhotometricInterpretation](#) ([PhotometricInterpretation](#) const &pi)
- void [SetPixelFormat](#) ([PixelFormat](#) const &pf)
- void [SetPlanarConfiguration](#) (unsigned int pc)
- void [SetRows](#) (unsigned int rows)
- void [SetTransferSyntax](#) ([TransferSyntax](#) const &ts)  
*Transfer syntax.*
- virtual bool [UnusedBitsPresentInPixelData](#) () const

## Protected Types

- typedef [SmartPointer](#)< [LookupTable](#) > [LUTPtr](#)

## Protected Member Functions

- bool [ComputeLossyFlag](#) ()
- bool [GetBuffer2](#) (std::ostream &os) const
- bool [TryJPEG2000Codec](#) (char \*buffer, bool &lossyflag) const
- bool [TryJPEG2000Codec2](#) (std::ostream &os) const
- bool [TryJPEGCodec](#) (char \*buffer, bool &lossyflag) const
- bool [TryJPEGCodec2](#) (std::ostream &os) const
- bool [TryJPEGLSCCodec](#) (char \*buffer, bool &lossyflag) const
- bool [TryKAKADUCodec](#) (char \*buffer, bool &lossyflag) const
- bool [TryPVRGCodec](#) (char \*buffer, bool &lossyflag) const
- bool [TryRAWCodec](#) (char \*buffer, bool &lossyflag) const
- bool [TryRLECodec](#) (char \*buffer, bool &lossyflag) const

## Protected Attributes

- std::vector< unsigned int > [Dimensions](#)
- bool [LossyFlag](#)
- [LUTPtr](#) [LUT](#)
- bool [NeedByteSwap](#)
- unsigned int [NumberOfDimensions](#)
- [PixelFormat](#) [PF](#)
- [PhotometricInterpretation](#) [PI](#)
- [DataElement](#) [PixelData](#)
- unsigned int [PlanarConfiguration](#)
- [TransferSyntax](#) [TS](#)

## Friends

- class [ImageChangeTransferSyntax](#)
- class [PixmapReader](#)

### 10.35.1 Detailed Description

[Bitmap](#) class.

A bitmap based image. Used as parent for both [IconImage](#) and the main Pixel Data [Image](#) It does not contains any World Space information (IPP, IOP)

#### Examples

[ExtractIconFromFile.cxx](#).



## 10.35.2 Member Typedef Documentation

### 10.35.2.1 LUTPtr

```
typedef SmartPointer<LookupTable> gdcm::Bitmap::LUTPtr [protected]
```

## 10.35.3 Constructor & Destructor Documentation

### 10.35.3.1 Bitmap()

```
gdcm::Bitmap::Bitmap ( )
```

### 10.35.3.2 ~Bitmap()

```
gdcm::Bitmap::~Bitmap ( ) [override]
```

## 10.35.4 Member Function Documentation

### 10.35.4.1 AreOverlaysInPixelData()

```
virtual bool gdcm::Bitmap::AreOverlaysInPixelData ( ) const [inline], [virtual]
```

Reimplemented in [gdcm::Pixmap](#).

### 10.35.4.2 Clear()

```
void gdcm::Bitmap::Clear ( )
```

### 10.35.4.3 ComputeLossyFlag()

```
bool gdcm::Bitmap::ComputeLossyFlag ( ) [protected]
```

### 10.35.4.4 GetBuffer()

```
bool gdcm::Bitmap::GetBuffer (
    char * buffer ) const
```

Access the raw data.

#### Examples

[ConvertToQImage.cxx](#), [ReadMultiTimesException.cxx](#), and [threadgdcm.cxx](#).

### 10.35.4.5 GetBuffer2()

```
bool gdcm::Bitmap::GetBuffer2 (
    std::ostream & os ) const [protected]
```

### 10.35.4.6 GetBufferLength()

```
unsigned long gdcm::Bitmap::GetBufferLength ( ) const
```

Return the length of the image after decompression WARNING for palette color: It will NOT take into account the Palette Color thus you need to multiply this length by 3 if computing the size of equivalent RGB image

#### Examples

[ConvertToQImage.cxx](#), [GenFakelImage.cxx](#), [GetSubSequenceData.cxx](#), [PatchFile.cxx](#), [ReadMultiTimesException.cxx](#), and [threadgdcm.cxx](#).

### 10.35.4.7 GetColumns()

```
unsigned int gdcm::Bitmap::GetColumns ( ) const [inline]
```

#### 10.35.4.8 GetDataElement() [1/2]

```
DataElement& gdcm::Bitmap::GetDataElement ( ) [inline]
```

#### 10.35.4.9 GetDataElement() [2/2]

```
const DataElement& gdcm::Bitmap::GetDataElement ( ) const [inline]
```

#### Examples

[ExtractIconFromFile.cxx](#).

#### 10.35.4.10 GetDimension()

```
unsigned int gdcm::Bitmap::GetDimension (
    unsigned int idx ) const
```

#### 10.35.4.11 GetDimensions()

```
const unsigned int* gdcm::Bitmap::GetDimensions ( ) const
```

Return the dimension of the pixel data, first dimension (x), then 2nd (y), then 3rd (z)...

#### Examples

[ConvertToQImage.cxx](#), [ExtractIconFromFile.cxx](#), [FixJAIBugJPEGLS.cxx](#), [HelloVizWorld.cxx](#), and [threadgdcm.cxx](#).

#### 10.35.4.12 GetLUT() [1/2]

```
LookupTable& gdcm::Bitmap::GetLUT ( ) [inline]
```

#### 10.35.4.13 GetLUT() [2/2]

```
const LookupTable& gdcm::Bitmap::GetLUT ( ) const [inline]
```

##### Examples

[ExtractIconFromFile.cxx](#), and [PrintLUT.cxx](#).

#### 10.35.4.14 GetNeedByteSwap()

```
bool gdcm::Bitmap::GetNeedByteSwap ( ) const [inline]
```

INTERNAL do not use.

#### 10.35.4.15 GetNumberOfDimensions()

```
unsigned int gdcm::Bitmap::GetNumberOfDimensions ( ) const
```

Return the number of dimension of the pixel data bytes; for example 2 for a 2D matrices of values.

##### Examples

[HelloVizWorld.cxx](#), and [threadgdcm.cxx](#).

#### 10.35.4.16 GetPhotometricInterpretation()

```
const PhotometricInterpretation& gdcm::Bitmap::GetPhotometricInterpretation ( ) const
```

return the photometric interpretation

##### Examples

[ConvertToQImage.cxx](#), [ExtractIconFromFile.cxx](#), and [HelloVizWorld.cxx](#).

#### 10.35.4.17 GetPixelFormat() [1/2]

```
PixelFormat& gdcm::Bitmap::GetPixelFormat ( ) [inline]
```

#### 10.35.4.18 GetPixelFormat() [2/2]

```
const PixelFormat& gdcm::Bitmap::GetPixelFormat ( ) const [inline]
```

Get/Set [PixelFormat](#).

#### Examples

[ConvertToQImage.cxx](#), [ExtractIconFromFile.cxx](#), [FixJAIBugJPEGLS.cxx](#), [GenFakeImage.cxx](#), [GetJPEGSamplePrecision.cxx](#), [TemplateEmptyImage.cxx](#), and [threadgdcm.cxx](#).

#### 10.35.4.19 GetPlanarConfiguration()

```
unsigned int gdcm::Bitmap::GetPlanarConfiguration ( ) const
```

return the planar configuration

#### 10.35.4.20 GetRows()

```
unsigned int gdcm::Bitmap::GetRows ( ) const [inline]
```

#### 10.35.4.21 GetTransferSyntax()

```
const TransferSyntax& gdcm::Bitmap::GetTransferSyntax ( ) const [inline]
```

#### Examples

[ExtractIconFromFile.cxx](#).

#### 10.35.4.22 IsEmpty()

```
bool gdcM::Bitmap::IsEmpty ( ) const [inline]
```

#### 10.35.4.23 IsLossy()

```
bool gdcM::Bitmap::IsLossy ( ) const
```

Return whether or not the image was compressed using a lossy compressor or not.

#### 10.35.4.24 IsTransferSyntaxCompatible()

```
bool gdcM::Bitmap::IsTransferSyntaxCompatible (
    TransferSyntax const & ts ) const
```

#### 10.35.4.25 Print()

```
void gdcM::Bitmap::Print (
    std::ostream & ) const [override], [virtual]
```

Reimplemented from [gdcM::Object](#).

Reimplemented in [gdcM::Image](#), and [gdcM::Pixmap](#).

#### Examples

[ExtractIconFromFile.cxx](#).

#### 10.35.4.26 SetColumns()

```
void gdcM::Bitmap::SetColumns (
    unsigned int col ) [inline]
```

#### 10.35.4.27 SetDataElement()

```
void gdcm::Bitmap::SetDataElement (
    DataElement const & de ) [inline]
```

##### Examples

[CreateARGBImage.cxx](#), [CreateCMYKImage.cxx](#), [GenFakeImage.cxx](#), [GetSubSequenceData.cxx](#), [csa2img.cxx](#), and [iU22tomultisc.cxx](#).

#### 10.35.4.28 SetDimension()

```
void gdcm::Bitmap::SetDimension (
    unsigned int idx,
    unsigned int dim )
```

##### Examples

[GenFakeImage.cxx](#), [GetSubSequenceData.cxx](#), [csa2img.cxx](#), and [iU22tomultisc.cxx](#).

#### 10.35.4.29 SetDimensions()

```
void gdcm::Bitmap::SetDimensions (
    const unsigned int dims[3] )
```

##### Examples

[CreateARGBImage.cxx](#), and [CreateCMYKImage.cxx](#).

#### 10.35.4.30 SetLossyFlag()

```
void gdcm::Bitmap::SetLossyFlag (
    bool f ) [inline]
```

Specifically set that the image was compressed using a lossy compression mechanism.

#### 10.35.4.31 SetLUT()

```
void gdcM::Bitmap::SetLUT (
    LookupTable const & lut ) [inline]
```

Set/Get LUT.

#### 10.35.4.32 SetNeedByteSwap()

```
void gdcM::Bitmap::SetNeedByteSwap (
    bool b ) [inline]
```

#### 10.35.4.33 SetNumberOfDimensions()

```
void gdcM::Bitmap::SetNumberOfDimensions (
    unsigned int dim )
```

##### Examples

[CreateARGBImage.cxx](#), [CreateCMYKImage.cxx](#), [FileChangeTS.cs](#), [FileChangeTSLossy.cs](#), [GenFakeImage.cxx](#), [GetSubSequenceData.cxx](#), [csa2img.cxx](#), and [iU22tomultisc.cxx](#).

#### 10.35.4.34 SetPhotometricInterpretation()

```
void gdcM::Bitmap::SetPhotometricInterpretation (
    PhotometricInterpretation const & pi )
```

##### Examples

[CreateARGBImage.cxx](#), [CreateCMYKImage.cxx](#), [GenFakeImage.cxx](#), [GetSubSequenceData.cxx](#), [csa2img.cxx](#), and [iU22tomultisc.cxx](#).



#### 10.35.4.35 SetPixelFormat()

```
void gdcm::Bitmap::SetPixelFormat (
    PixelFormat const & pf ) [inline]
```

##### Examples

[CreateARGBImage.cxx](#), [CreateCMYKImage.cxx](#), [csa2img.cxx](#), and [iU22tomultisc.cxx](#).

References `gdcm::PixelFormat::Validate()`.

#### 10.35.4.36 SetPlanarConfiguration()

```
void gdcm::Bitmap::SetPlanarConfiguration (
    unsigned int pc )
```

##### Warning

you need to call `SetPixelFormat` first (before `SetPlanarConfiguration`) for consistency checking

#### 10.35.4.37 SetRows()

```
void gdcm::Bitmap::SetRows (
    unsigned int rows ) [inline]
```

#### 10.35.4.38 SetTransferSyntax()

```
void gdcm::Bitmap::SetTransferSyntax (
    TransferSyntax const & ts ) [inline]
```

Transfer syntax.

##### Examples

[CreateARGBImage.cxx](#), [CreateCMYKImage.cxx](#), and [MergeTwoFiles.cxx](#).

#### 10.35.4.39 TryJPEG2000Codec()

```
bool gdcM::Bitmap::TryJPEG2000Codec (
    char * buffer,
    bool & lossyflag ) const [protected]
```

#### 10.35.4.40 TryJPEG2000Codec2()

```
bool gdcM::Bitmap::TryJPEG2000Codec2 (
    std::ostream & os ) const [protected]
```

#### 10.35.4.41 TryJPEGCodec()

```
bool gdcM::Bitmap::TryJPEGCodec (
    char * buffer,
    bool & lossyflag ) const [protected]
```

#### 10.35.4.42 TryJPEGCodec2()

```
bool gdcM::Bitmap::TryJPEGCodec2 (
    std::ostream & os ) const [protected]
```

#### 10.35.4.43 TryJPEGLSCodec()

```
bool gdcM::Bitmap::TryJPEGLSCodec (
    char * buffer,
    bool & lossyflag ) const [protected]
```

#### 10.35.4.44 TryKAKADUCodec()

```
bool gdcM::Bitmap::TryKAKADUCodec (
    char * buffer,
    bool & lossyflag ) const [protected]
```

#### 10.35.4.45 TryPVRGCodec()

```
bool gdcm::Bitmap::TryPVRGCodec (
    char * buffer,
    bool & lossyflag ) const [protected]
```

#### 10.35.4.46 TryRAWCodec()

```
bool gdcm::Bitmap::TryRAWCodec (
    char * buffer,
    bool & lossyflag ) const [protected]
```

#### 10.35.4.47 TryRLECodec()

```
bool gdcm::Bitmap::TryRLECodec (
    char * buffer,
    bool & lossyflag ) const [protected]
```

#### 10.35.4.48 UnusedBitsPresentInPixelData()

```
virtual bool gdcm::Bitmap::UnusedBitsPresentInPixelData ( ) const [inline], [virtual]
```

Reimplemented in [gdcm::Pixmap](#).

### 10.35.5 Friends And Related Function Documentation

#### 10.35.5.1 ImageChangeTransferSyntax

```
friend class ImageChangeTransferSyntax [friend]
```

#### 10.35.5.2 PixmapReader

```
friend class PixmapReader [friend]
```

## 10.35.6 Member Data Documentation

### 10.35.6.1 Dimensions

`std::vector<unsigned int> gdcM::Bitmap::Dimensions` [protected]

### 10.35.6.2 LossyFlag

`bool gdcM::Bitmap::LossyFlag` [protected]

### 10.35.6.3 LUT

`LUTPtr gdcM::Bitmap::LUT` [protected]

### 10.35.6.4 NeedByteSwap

`bool gdcM::Bitmap::NeedByteSwap` [protected]

### 10.35.6.5 NumberOfDimensions

`unsigned int gdcM::Bitmap::NumberOfDimensions` [protected]

### 10.35.6.6 PF

`PixelFormat gdcM::Bitmap::PF` [protected]

### 10.35.6.7 PI

[PhotometricInterpretation](#) gdcm::Bitmap::PI [protected]

### 10.35.6.8 PixelData

[DataElement](#) gdcm::Bitmap::PixelData [protected]

### 10.35.6.9 PlanarConfiguration

unsigned int gdcm::Bitmap::PlanarConfiguration [protected]

### 10.35.6.10 TS

[TransferSyntax](#) gdcm::Bitmap::TS [protected]

The documentation for this class was generated from the following file:

- [gdcmBitmap.h](#)

## 10.36 gdcm::BitmapToBitmapFilter Class Reference

[BitmapToBitmapFilter](#) class.

```
#include <gdcmBitmapToBitmapFilter.h>
```

Inheritance diagram for gdcm::BitmapToBitmapFilter:

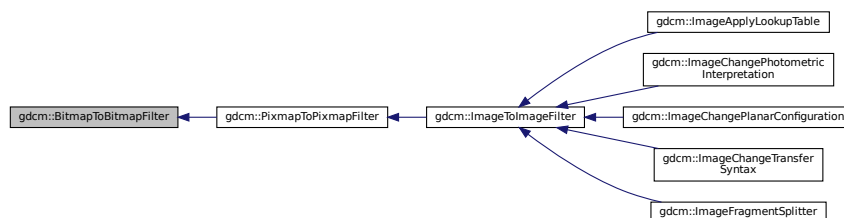

Collaboration diagram for `gdcm::BitmapToBitmapFilter`:

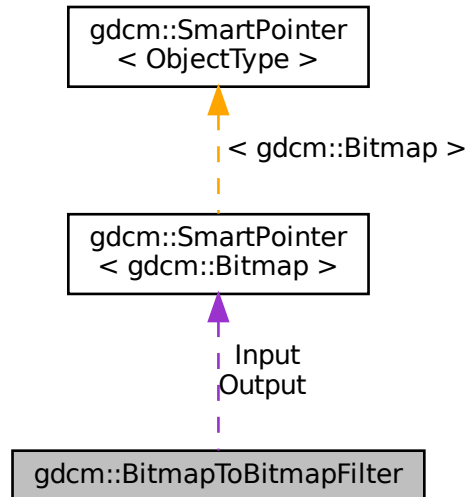

## Public Member Functions

- [BitmapToBitmapFilter](#) ()
- [~BitmapToBitmapFilter](#) ()=default
- const [Bitmap](#) & [GetOutput](#) () const  
*Get Output image.*
- const [Bitmap](#) & [GetOutputAsBitmap](#) () const
- void [SetInput](#) (const [Bitmap](#) &image)  
*Set input image.*

## Protected Attributes

- [SmartPointer](#)< [Bitmap](#) > [Input](#)
- [SmartPointer](#)< [Bitmap](#) > [Output](#)

### 10.36.1 Detailed Description

[BitmapToBitmapFilter](#) class.

Super class for all filter taking an image and producing an output image

## 10.36.2 Constructor & Destructor Documentation

### 10.36.2.1 BitmapToBitmapFilter()

```
gdcm::BitmapToBitmapFilter::BitmapToBitmapFilter ( )
```

### 10.36.2.2 ~BitmapToBitmapFilter()

```
gdcm::BitmapToBitmapFilter::~~BitmapToBitmapFilter ( ) [default]
```

## 10.36.3 Member Function Documentation

### 10.36.3.1 GetOutput()

```
const Bitmap& gdcm::BitmapToBitmapFilter::GetOutput ( ) const [inline]
```

Get Output image.

### 10.36.3.2 GetOutputAsBitmap()

```
const Bitmap& gdcm::BitmapToBitmapFilter::GetOutputAsBitmap ( ) const
```

### 10.36.3.3 SetInput()

```
void gdcm::BitmapToBitmapFilter::SetInput (
    const Bitmap & image )
```

Set input image.

#### Examples

[CompressImage.cxx](#).

## 10.36.4 Member Data Documentation

### 10.36.4.1 Input

`SmartPointer<Bitmap>` `gdcM::BitmapToBitmapFilter::Input` [protected]

### 10.36.4.2 Output

`SmartPointer<Bitmap>` `gdcM::BitmapToBitmapFilter::Output` [protected]

The documentation for this class was generated from the following file:

- [gdcMBitmapToBitmapFilter.h](#)

## 10.37 gdcM::BoxRegion Class Reference

Class for manipulation box region.

```
#include <gdcMBoxRegion.h>
```

Inheritance diagram for `gdcM::BoxRegion`:

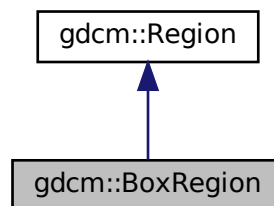



Collaboration diagram for gdcm::BoxRegion:

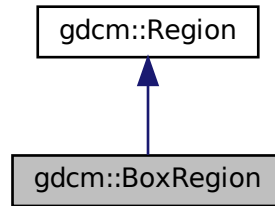

## Public Member Functions

- [BoxRegion](#) ()
- [BoxRegion](#) (const [BoxRegion](#) &)  
*copy/cstor and al.*
- [~BoxRegion](#) () override
- [size\\_t Area](#) () const override  
*compute the area*
- [Region \\* Clone](#) () const override
- [BoxRegion ComputeBoundingBox](#) () override  
*Return the Axis-Aligned minimum bounding box for all regions.*
- [bool Empty](#) () const override  
*return whether this domain is empty:*
- [unsigned int GetXMax](#) () const
- [unsigned int GetXMin](#) () const  
*Get domain.*
- [unsigned int GetYMax](#) () const
- [unsigned int GetYMin](#) () const
- [unsigned int GetZMax](#) () const
- [unsigned int GetZMin](#) () const
- [bool IsValid](#) () const override  
*return whether this is valid domain*
- [void operator=](#) (const [BoxRegion](#) &)
- [void Print](#) (std::ostream &os=std::cout) const override  
*Print.*
- [void SetDomain](#) (unsigned int xmin, unsigned int xmax, unsigned int ymin, unsigned int ymax, unsigned int zmin, unsigned int zmax)  
*Set domain.*

## Static Public Member Functions

- [static BoxRegion BoundingBox](#) ([BoxRegion](#) const &b1, [BoxRegion](#) const &b2)  
*Helper class to compute the bounding box of two [BoxRegion](#).*

### 10.37.1 Detailed Description

Class for manipulation box region.

This is a very simple implementation of the [Region](#) class. It only support 3D box type region. It assumes the 3D Box does not have a tilt Origin is as (0,0,0)

### 10.37.2 Constructor & Destructor Documentation

#### 10.37.2.1 [BoxRegion\(\)](#) [1/2]

```
gdcM::BoxRegion::BoxRegion ( )
```

#### 10.37.2.2 [~BoxRegion\(\)](#)

```
gdcM::BoxRegion::~~BoxRegion ( ) [override]
```

#### 10.37.2.3 [BoxRegion\(\)](#) [2/2]

```
gdcM::BoxRegion::BoxRegion (
    const BoxRegion & )
```

copy/cstor and al.

### 10.37.3 Member Function Documentation

#### 10.37.3.1 [Area\(\)](#)

```
size_t gdcM::BoxRegion::Area ( ) const [override], [virtual]
```

compute the area

Implements [gdcM::Region](#).

### 10.37.3.2 BoundingBox()

```
static BoxRegion gdcm::BoxRegion::BoundingBox (
    BoxRegion const & b1,
    BoxRegion const & b2 ) [static]
```

Helper class to compute the bounding box of two [BoxRegion](#).

### 10.37.3.3 Clone()

```
Region\* gdcm::BoxRegion::Clone ( ) const [override], [virtual]
```

Implements [gdcm::Region](#).

### 10.37.3.4 ComputeBoundingBox()

```
BoxRegion gdcm::BoxRegion::ComputeBoundingBox ( ) [override], [virtual]
```

Return the Axis-Aligned minimum bounding box for all regions.

Implements [gdcm::Region](#).

### 10.37.3.5 Empty()

```
bool gdcm::BoxRegion::Empty ( ) const [override], [virtual]
```

return whether this domain is empty:

Implements [gdcm::Region](#).

### 10.37.3.6 GetXMax()

```
unsigned int gdcm::BoxRegion::GetXMax ( ) const
```

### 10.37.3.7 GetXMin()

```
unsigned int gdcm::BoxRegion::GetXMin ( ) const
```

Get domain.

### 10.37.3.8 GetYMax()

```
unsigned int gdcm::BoxRegion::GetYMax ( ) const
```

### 10.37.3.9 GetYMin()

```
unsigned int gdcm::BoxRegion::GetYMin ( ) const
```

### 10.37.3.10 GetZMax()

```
unsigned int gdcm::BoxRegion::GetZMax ( ) const
```

### 10.37.3.11 GetZMin()

```
unsigned int gdcm::BoxRegion::GetZMin ( ) const
```

### 10.37.3.12 IsValid()

```
bool gdcm::BoxRegion::IsValid ( ) const [override], [virtual]
```

return whether this is valid domain

Implements [gdcm::Region](#).

### 10.37.3.13 operator=()

```
void gdcmm::BoxRegion::operator= (
    const BoxRegion & )
```

### 10.37.3.14 Print()

```
void gdcmm::BoxRegion::Print (
    std::ostream & os = std::cout ) const [override], [virtual]
```

Print.

Reimplemented from [gdcmm::Region](#).

### 10.37.3.15 SetDomain()

```
void gdcmm::BoxRegion::SetDomain (
    unsigned int xmin,
    unsigned int xmax,
    unsigned int ymin,
    unsigned int ymax,
    unsigned int zmin,
    unsigned int zmax )
```

Set domain.

The documentation for this class was generated from the following file:

- [gdcmmBoxRegion.h](#)

## 10.38 gdcmm::ByteBuffer Class Reference

[ByteBuffer](#).

```
#include <gdcmmByteBuffer.h>
```

### Public Member Functions

- [ByteBuffer](#) ()
- char \* [Get](#) (int len)
- const char \* [GetStart](#) () const
- void [ShiftEnd](#) (int len)
- void [UpdatePosition](#) ()

## 10.38.1 Detailed Description

[ByteBuffer](#).

Detailed description here

### Note

looks like a `std::streambuf` or `std::filebuf` class with the `get` and `peek` pointer

## 10.38.2 Constructor & Destructor Documentation

### 10.38.2.1 ByteBuffer()

```
gdcmm::ByteBuffer::ByteBuffer ( ) [inline]
```

## 10.38.3 Member Function Documentation

### 10.38.3.1 Get()

```
char* gdcmm::ByteBuffer::Get (
    int len ) [inline]
```

### 10.38.3.2 GetStart()

```
const char* gdcmm::ByteBuffer::GetStart ( ) const [inline]
```

### 10.38.3.3 ShiftEnd()

```
void gdcmm::ByteBuffer::ShiftEnd (
    int len ) [inline]
```

### 10.38.3.4 UpdatePosition()

```
void gdcm::ByteBuffer::UpdatePosition ( ) [inline]
```

The documentation for this class was generated from the following file:

- [gdcmByteBuffer.h](#)

## 10.39 gdcm::ByteSwap< T > Class Template Reference

[ByteSwap](#).

```
#include <gdcmByteSwap.h>
```

### Static Public Member Functions

- static void [Swap](#) (T &p)
- static void [SwapFromSwapCodeIntoSystem](#) (T &p, [SwapCode](#) const &sc)
- static void [SwapRange](#) (T \*p, unsigned int num)
- static void [SwapRangeFromSwapCodeIntoSystem](#) (T \*p, [SwapCode](#) const &sc, std::streamoff num)
- static bool [SystemIsBigEndian](#) ()
- static bool [SystemIsLittleEndian](#) ()

### 10.39.1 Detailed Description

```
template<class T>  
class gdcm::ByteSwap< T >
```

[ByteSwap](#).

Perform machine dependent byte swapping (Little Endian, Big Endian, Bad Little Endian, Bad Big Endian). TODO: bswap\_32 / bswap\_64 ...

Examples

[TestByteSwap.cxx](#).

### 10.39.2 Member Function Documentation

### 10.39.2.1 Swap()

```
template<class T >
static void gdcm::ByteSwap< T >::Swap (
    T & p ) [static]
```

### 10.39.2.2 SwapFromSwapCodeIntoSystem()

```
template<class T >
static void gdcm::ByteSwap< T >::SwapFromSwapCodeIntoSystem (
    T & p,
    SwapCode const & sc ) [static]
```

#### Examples

[TestByteSwap.cxx](#).

### 10.39.2.3 SwapRange()

```
template<class T >
static void gdcm::ByteSwap< T >::SwapRange (
    T * p,
    unsigned int num ) [static]
```

### 10.39.2.4 SwapRangeFromSwapCodeIntoSystem()

```
template<class T >
static void gdcm::ByteSwap< T >::SwapRangeFromSwapCodeIntoSystem (
    T * p,
    SwapCode const & sc,
    std::streamoff num ) [static]
```

#### Examples

[TestByteSwap.cxx](#).



### 10.39.2.5 SystemIsBigEndian()

```
template<class T >
static bool gdcm::ByteSwap< T >::SystemIsBigEndian ( ) [static]
```

Query the machine Endian-ness.

### 10.39.2.6 SystemIsLittleEndian()

```
template<class T >
static bool gdcm::ByteSwap< T >::SystemIsLittleEndian ( ) [static]
```

The documentation for this class was generated from the following file:

- [gdcmByteSwap.h](#)

## 10.40 gdcm::ByteSwapFilter Class Reference

[ByteSwapFilter](#).

```
#include <gdcmByteSwapFilter.h>
```

### Public Member Functions

- [ByteSwapFilter](#) (const [ByteSwapFilter](#) &)=delete
- [ByteSwapFilter](#) ([DataSet](#) &ds)
- [~ByteSwapFilter](#) ()
- bool [ByteSwap](#) ()
- [ByteSwapFilter](#) & [operator=](#) (const [ByteSwapFilter](#) &)=delete
- void [SetByteSwapTag](#) (bool b)

### 10.40.1 Detailed Description

[ByteSwapFilter](#).

In place byte-swapping of a dataset FIXME: FL status ??

### 10.40.2 Constructor & Destructor Documentation

#### 10.40.2.1 ByteSwapFilter() [1/2]

```
gdcM::ByteSwapFilter::ByteSwapFilter (
    DataSet & ds ) [inline]
```

#### 10.40.2.2 ~ByteSwapFilter()

```
gdcM::ByteSwapFilter::~~ByteSwapFilter ( )
```

#### 10.40.2.3 ByteSwapFilter() [2/2]

```
gdcM::ByteSwapFilter::ByteSwapFilter (
    const ByteSwapFilter & ) [delete]
```

### 10.40.3 Member Function Documentation

#### 10.40.3.1 ByteSwap()

```
bool gdcM::ByteSwapFilter::ByteSwap ( )
```

Referenced by `gdcM::Item::Read()`.

#### 10.40.3.2 operator=()

```
ByteSwapFilter& gdcM::ByteSwapFilter::operator= (
    const ByteSwapFilter & ) [delete]
```

#### 10.40.3.3 SetByteSwapTag()

```
void gdcM::ByteSwapFilter::SetByteSwapTag (
    bool b ) [inline]
```

Referenced by `gdcM::Item::Read()`.

The documentation for this class was generated from the following file:

- [gdcMByteSwapFilter.h](#)

## 10.41 gdcm::ByteValue Class Reference

Class to represent binary value (array of bytes)

```
#include <gdcmByteValue.h>
```

Inheritance diagram for gdcm::ByteValue:

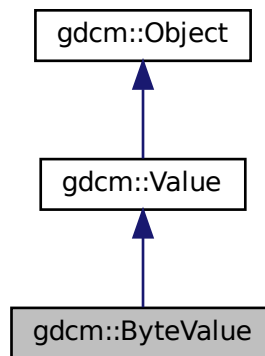

Collaboration diagram for gdcm::ByteValue:

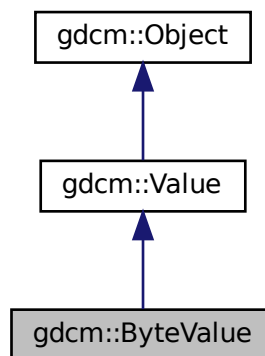

## Public Member Functions

- [ByteValue](#) (const char \*array=nullptr, VL const &vl=0)
- [ByteValue](#) (std::vector< char > &v)
- [~ByteValue](#) () override
- void [Append](#) ([ByteValue](#) const &bv)
- void [Clear](#) () override
- [VL ComputeLength](#) () const
- void [Fill](#) (char c)
- bool [GetBuffer](#) (char \*buffer, unsigned long length) const
- [VL GetLength](#) () const override
- const char \* [GetPointer](#) () const
- void \* [GetVoidPointer](#) ()
- const void \* [GetVoidPointer](#) () const
- bool [IsEmpty](#) () const
- bool [IsPrintable](#) (VL length) const

*Checks whether a 'ByteValue' is printable or not (in order to avoid corrupting the terminal of invocation when printing) I don't think this function is working since it does not handle UNICODE or character set...*

- [operator const std::vector< char > & \(\)](#) const
- [ByteValue & operator=](#) (const [ByteValue](#) &val)
- bool [operator==](#) (const [ByteValue](#) &val) const
- bool [operator==](#) (const [Value](#) &val) const override
- void [PrintASCII](#) (std::ostream &os, VL maxlength) const
- void [PrintASCIIXML](#) (std::ostream &os) const
- void [PrintGroupLength](#) (std::ostream &os)
- void [PrintHex](#) (std::ostream &os, VL maxlength) const
- void [PrintHexXML](#) (std::ostream &os) const
- void [PrintPNXML](#) (std::ostream &os) const
- template<typename TSwap >  
std::istream & [Read](#) (std::istream &is)
- template<typename TSwap, typename TType >  
std::istream & [Read](#) (std::istream &is, bool readvalues=true)
- void [SetLength](#) (VL vl) override
- template<typename TSwap, typename TType >  
std::ostream const & [Write](#) (std::ostream &os) const
- template<typename TSwap >  
std::ostream const & [Write](#) (std::ostream &os) const
- bool [WriteBuffer](#) (std::ostream &os) const

## Protected Member Functions

- void [Print](#) (std::ostream &os) const override
- void [SetLengthOnly](#) (VL vl) override

## 10.41.1 Detailed Description

Class to represent binary value (array of bytes)

Note

Examples

[DumpADAC.cxx](#), [DumpExamCard.cxx](#), [DumpGEMSMovieGroup.cxx](#), [DumpImageHeaderInfo.cxx](#), [DumpSiemensBase64.cxx](#), [DumpToshibaDTI.cxx](#), [DumpToshibaDTI2.cxx](#), [DuplicatePCDE.cxx](#), [ELSCINT1WaveToText.cxx](#), [ExtractEncryptedContent.cxx](#), [ExtractIconFromFile.cxx](#), [FixBrokenJ2K.cxx](#), [FixJAIBugJPEGSL.cxx](#), [MrProtocol.cxx](#), [PatchFile.cxx](#), [pmsct\\_rgb1.cxx](#), and [rle2img.cxx](#).

## 10.41.2 Constructor & Destructor Documentation

### 10.41.2.1 ByteValue() [1/2]

```
gdcmm::ByteValue::ByteValue (
    const char * array = nullptr,
    VL const & vl = 0 ) [inline]
```

References [gdcmmDebugMacro](#).

### 10.41.2.2 ByteValue() [2/2]

```
gdcmm::ByteValue::ByteValue (
    std::vector< char > & v ) [inline]
```

Warning

casting to `uint32_t`

### 10.41.2.3 ~ByteValue()

```
gdcmm::ByteValue::~~ByteValue ( ) [inline], [override]
```

## 10.41.3 Member Function Documentation

### 10.41.3.1 Append()

```
void gdcM::ByteValue::Append (
    ByteValue const & bv )
```

### 10.41.3.2 Clear()

```
void gdcM::ByteValue::Clear ( ) [inline], [override], [virtual]
```

Implements [gdcM::Value](#).

### 10.41.3.3 ComputeLength()

```
VL gdcM::ByteValue::ComputeLength ( ) const [inline]
```

Referenced by [gdcM::Fragment::Write\(\)](#).

### 10.41.3.4 Fill()

```
void gdcM::ByteValue::Fill (
    char c ) [inline]
```

#### Examples

[DuplicatePCDE.cxx](#).

### 10.41.3.5 GetBuffer()

```
bool gdcM::ByteValue::GetBuffer (
    char * buffer,
    unsigned long length ) const
```

#### Examples

[FixJAIBugJPEGSL.cxx](#).

### 10.41.3.6 GetLength()

```
VL gdcm::ByteValue::GetLength ( ) const [inline], [override], [virtual]
```

Implements [gdcm::Value](#).

#### Examples

[DumpADAC.cxx](#), [DumpExamCard.cxx](#), [DumpGEMSMovieGroup.cxx](#), [DumpImageHeaderInfo.cxx](#), [DumpSiemensBase64.cxx](#), [DumpToshibaDTI.cxx](#), [DumpToshibaDTI2.cxx](#), [ELSCINT1WaveToText.cxx](#), [ExtractEncryptedContent.cxx](#), [ExtractIconFromFile.cxx](#), [FixBrokenJ2K.cxx](#), [FixJAIBugJPEGLS.cxx](#), [MrProtocol.cxx](#), [PatchFile.cxx](#), [pmsct\\_rgb1.cxx](#), and [rle2img.cxx](#).

Referenced by [gdcm::SequenceOfFragments::ReadValue\(\)](#), [gdcm::Element< TVR, TVM >::Set\(\)](#), [gdcm::Element< TVR, VM::VM1\\_n >::Set\(\)](#), [gdcm::Attribute< Group, Element, TVR, TVM >::SetByteValue\(\)](#), [gdcm::Attribute< Group, Element, TVR, VM::VM1 >::SetByteValue\(\)](#), [gdcm::Attribute< Group, Element, TVR, VM::VM1\\_n >::SetByteValue\(\)](#), [gdcm::Attribute< Group, Element, TVR, TVM >::SetByteValueNoSwap\(\)](#), [gdcm::Attribute< Group, Element, TVR, VM::VM1 >::SetByteValueNoSwap\(\)](#), [gdcm::Element< TVR, TVM >::SetNoSwap\(\)](#), [gdcm::Element< TVR, VM::VM1↵\\_n >::SetNoSwap\(\)](#), and [gdcm::Fragment::Write\(\)](#).

### 10.41.3.7 GetPointer()

```
const char* gdcm::ByteValue::GetPointer ( ) const [inline]
```

#### Examples

[DumpADAC.cxx](#), [DumpExamCard.cxx](#), [DumpGEMSMovieGroup.cxx](#), [DumpImageHeaderInfo.cxx](#), [DumpSiemensBase64.cxx](#), [DumpToshibaDTI.cxx](#), [DumpToshibaDTI2.cxx](#), [ELSCINT1WaveToText.cxx](#), [ExtractEncryptedContent.cxx](#), [ExtractIconFromFile.cxx](#), [MrProtocol.cxx](#), [pmsct\\_rgb1.cxx](#), and [rle2img.cxx](#).

Referenced by [gdcm::SequenceOfFragments::ReadValue\(\)](#), [gdcm::Element< TVR, TVM >::Set\(\)](#), [gdcm::Element< TVR, VM::VM1\\_n >::Set\(\)](#), [gdcm::Attribute< Group, Element, TVR, TVM >::SetByteValue\(\)](#), [gdcm::Attribute< Group, Element, TVR, VM::VM1 >::SetByteValue\(\)](#), [gdcm::Attribute< Group, Element, TVR, VM::VM1\\_n >::SetByteValue\(\)](#), [gdcm::Attribute< Group, Element, TVR, TVM >::SetByteValueNoSwap\(\)](#), [gdcm::Attribute< Group, Element, TVR, VM::VM1 >::SetByteValueNoSwap\(\)](#), [gdcm::Element< TVR, TVM >::SetNoSwap\(\)](#), and [gdcm::Element< TVR, VM↵::VM1\\_n >::SetNoSwap\(\)](#).

### 10.41.3.8 GetVoidPointer() [1/2]

```
void* gdcm::ByteValue::GetVoidPointer ( ) [inline]
```

### 10.41.3.9 GetVoidPointer() [2/2]

```
const void* gdcM::ByteValue::GetVoidPointer ( ) const [inline]
```

#### Examples

[FixBrokenJ2K.cxx](#).

Referenced by `gdcM::Element< TVR, VM::VM1_n >::Set()`.

### 10.41.3.10 IsEmpty()

```
bool gdcM::ByteValue::IsEmpty ( ) const [inline]
```

### 10.41.3.11 IsPrintable()

```
bool gdcM::ByteValue::IsPrintable (
    VL length ) const [inline]
```

Checks whether a 'ByteValue' is printable or not (in order to avoid corrupting the terminal of invocation when printing) I don't think this function is working since it does not handle UNICODE or character set...

### 10.41.3.12 operator const std::vector< char > &()

```
gdcM::ByteValue::operator const std::vector< char > & ( ) const [inline]
```

### 10.41.3.13 operator=()

```
ByteValue& gdcM::ByteValue::operator= (
    const ByteValue & val ) [inline]
```



#### 10.41.3.14 operator==( ) [1/2]

```
bool gdcmm::ByteValue::operator==(
    const ByteValue & val ) const [inline]
```

#### 10.41.3.15 operator==( ) [2/2]

```
bool gdcmm::ByteValue::operator==(
    const Value & val ) const [inline], [override], [virtual]
```

Implements [gdcmm::Value](#).

#### 10.41.3.16 Print()

```
void gdcmm::ByteValue::Print (
    std::ostream & os ) const [inline], [override], [protected], [virtual]
```

Reimplemented from [gdcmm::Object](#).

#### 10.41.3.17 PrintASCII()

```
void gdcmm::ByteValue::PrintASCII (
    std::ostream & os,
    VL maxlength ) const
```

#### 10.41.3.18 PrintASCIIXML()

```
void gdcmm::ByteValue::PrintASCIIXML (
    std::ostream & os ) const
```

#### 10.41.3.19 PrintGroupLength()

```
void gdcmm::ByteValue::PrintGroupLength (
    std::ostream & os ) [inline]
```

#### 10.41.3.20 PrintHex()

```
void gdcM::ByteValue::PrintHex (
    std::ostream & os,
    VL maxlength ) const
```

#### 10.41.3.21 PrintHexXML()

```
void gdcM::ByteValue::PrintHexXML (
    std::ostream & os ) const
```

#### 10.41.3.22 PrintPXML()

```
void gdcM::ByteValue::PrintPXML (
    std::ostream & os ) const
```

To Print Values in Native DICOM format

#### 10.41.3.23 Read() [1/2]

```
template<typename TSwap >
std::istream& gdcM::ByteValue::Read (
    std::istream & is ) [inline]
```

#### 10.41.3.24 Read() [2/2]

```
template<typename TSwap , typename TType >
std::istream& gdcM::ByteValue::Read (
    std::istream & is,
    bool readvalues = true ) [inline]
```

#### 10.41.3.25 SetLength()

```
void gdcM::ByteValue::SetLength (
    VL vl ) [override], [virtual]
```

Implements [gdcM::Value](#).

#### Examples

[ReadExplicitLengthSQIVR.cxx](#).

### 10.41.3.26 SetLengthOnly()

```
void gdcM::ByteValue::SetLengthOnly (
    VL vl ) [inline], [override], [protected], [virtual]
```

Reimplemented from [gdcM::Value](#).

### 10.41.3.27 Write() [1/2]

```
template<typename TSwap , typename TType >
std::ostream const& gdcM::ByteValue::Write (
    std::ostream & os ) const [inline]
```

Referenced by [gdcM::Fragment::Write\(\)](#).

### 10.41.3.28 Write() [2/2]

```
template<typename TSwap >
std::ostream const& gdcM::ByteValue::Write (
    std::ostream & os ) const [inline]
```

### 10.41.3.29 WriteBuffer()

```
bool gdcM::ByteValue::WriteBuffer (
    std::ostream & os ) const [inline]
```

The documentation for this class was generated from the following file:

- [gdcMByteValue.h](#)

## 10.42 gdcm::CAPICryptoFactory Class Reference

```
#include <gdcmCAPICryptoFactory.h>
```

Inheritance diagram for gdcm::CAPICryptoFactory:

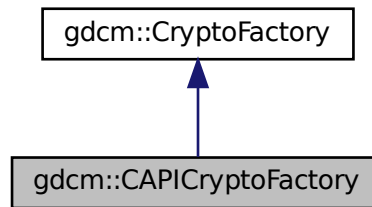

Collaboration diagram for gdcm::CAPICryptoFactory:

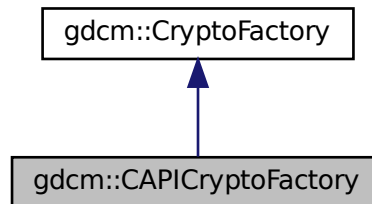

### Public Member Functions

- [CAPICryptoFactory](#) ([CryptoLib](#) id)
- [CryptographicMessageSyntax](#) \* [CreateCMSProvider](#) ()

### Additional Inherited Members

#### 10.42.1 Constructor & Destructor Documentation

### 10.42.1.1 CAPICryptoFactory()

```
gdcM::CAPICryptoFactory::CAPICryptoFactory (
    CryptoLib id )
```

## 10.42.2 Member Function Documentation

### 10.42.2.1 CreateCMSProvider()

```
CryptographicMessageSyntax* gdcM::CAPICryptoFactory::CreateCMSProvider ( ) [virtual]
```

Implements [gdcM::CryptoFactory](#).

The documentation for this class was generated from the following file:

- [gdcMCAPICryptoFactory.h](#)

## 10.43 gdcM::CAPICryptographicMessageSyntax Class Reference

```
#include <gdcMCAPICryptographicMessageSyntax.h>
```

Inheritance diagram for gdcM::CAPICryptographicMessageSyntax:

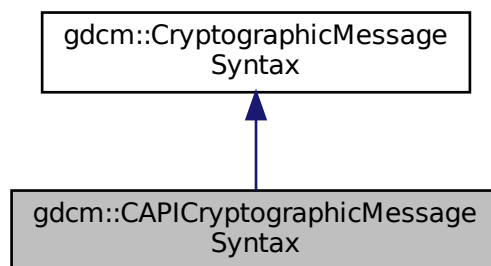

Collaboration diagram for `gdcM::CAPICryptographicMessageSyntax`:

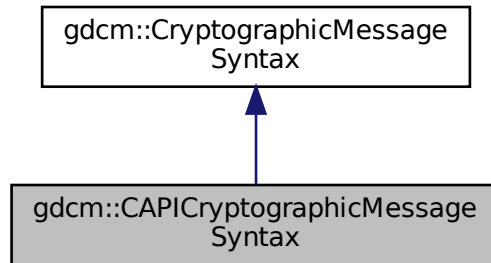

## Public Member Functions

- [CAPICryptographicMessageSyntax](#) ()
- [~CAPICryptographicMessageSyntax](#) ()
- bool [Decrypt](#) (char \*output, size\_t &outlen, const char \*array, size\_t len) const  
*decrypt content from a CMS envelopedData structure*
- bool [Encrypt](#) (char \*output, size\_t &outlen, const char \*array, size\_t len) const  
*create a CMS envelopedData structure*
- [CipherTypes GetCipherType](#) () const
- bool [GetInitialized](#) () const
- bool [ParseCertificateFile](#) (const char \*filename)
- bool [ParseKeyFile](#) (const char \*filename)
- void [SetCipherType](#) ([CipherTypes](#) type)
- bool [SetPassword](#) (const char \*pass, size\_t passLen)

## Additional Inherited Members

### 10.43.1 Constructor & Destructor Documentation

#### 10.43.1.1 CAPICryptographicMessageSyntax()

```
gdcM::CAPICryptographicMessageSyntax::CAPICryptographicMessageSyntax ( )
```

### 10.43.1.2 ~CAPICryptographicMessageSyntax()

```
gdcM::CAPICryptographicMessageSyntax::~~CAPICryptographicMessageSyntax ( )
```

## 10.43.2 Member Function Documentation

### 10.43.2.1 Decrypt()

```
bool gdcM::CAPICryptographicMessageSyntax::Decrypt (
    char * output,
    size_t & outlen,
    const char * array,
    size_t len ) const [virtual]
```

decrypt content from a CMS envelopedData structure

Implements [gdcM::CryptographicMessageSyntax](#).

### 10.43.2.2 Encrypt()

```
bool gdcM::CAPICryptographicMessageSyntax::Encrypt (
    char * output,
    size_t & outlen,
    const char * array,
    size_t len ) const [virtual]
```

create a CMS envelopedData structure

Implements [gdcM::CryptographicMessageSyntax](#).

### 10.43.2.3 GetCipherType()

```
CipherTypes gdcM::CAPICryptographicMessageSyntax::GetCipherType ( ) const [virtual]
```

Implements [gdcM::CryptographicMessageSyntax](#).

#### 10.43.2.4 GetInitialized()

```
bool gdcM::CAPICryptographicMessageSyntax::GetInitialized ( ) const [inline]
```

#### 10.43.2.5 ParseCertificateFile()

```
bool gdcM::CAPICryptographicMessageSyntax::ParseCertificateFile (
    const char * filename ) [virtual]
```

Implements [gdcM::CryptographicMessageSyntax](#).

#### 10.43.2.6 ParseKeyFile()

```
bool gdcM::CAPICryptographicMessageSyntax::ParseKeyFile (
    const char * filename ) [virtual]
```

Implements [gdcM::CryptographicMessageSyntax](#).

#### 10.43.2.7 SetCipherType()

```
void gdcM::CAPICryptographicMessageSyntax::SetCipherType (
    CipherTypes type ) [virtual]
```

Implements [gdcM::CryptographicMessageSyntax](#).

#### 10.43.2.8 SetPassword()

```
bool gdcM::CAPICryptographicMessageSyntax::SetPassword (
    const char * pass,
    size_t passLen ) [virtual]
```

Implements [gdcM::CryptographicMessageSyntax](#).

The documentation for this class was generated from the following file:

- [gdcMCAPICryptographicMessageSyntax.h](#)



## 10.44 gdcm::network::CEchoRQ Class Reference

[CEchoRQ](#).

```
#include <gdcmCEchoMessages.h>
```

Inheritance diagram for gdcm::network::CEchoRQ:

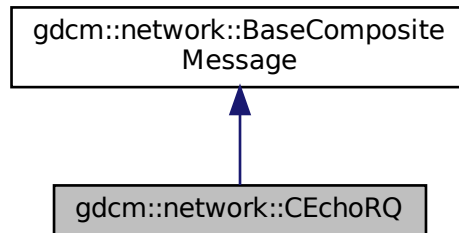

Collaboration diagram for gdcm::network::CEchoRQ:

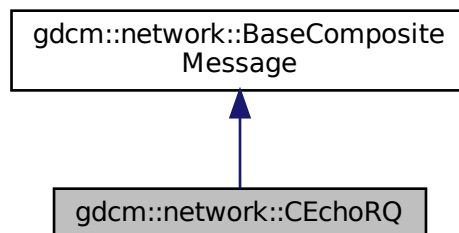

### Public Member Functions

- `std::vector< PresentationDataValue > ConstructPDV` (const [ULConnection](#) &inConnection, const [BaseRootQuery](#) \*inRootQuery) override

### Public Attributes

- [UIComp AffectedSOPClassUID](#)
- `uint16_t` [MessageID](#)

### 10.44.1 Detailed Description

[CEchoRQ](#).

this file defines the messages for the cecho action

### 10.44.2 Member Function Documentation

#### 10.44.2.1 ConstructPDV()

```
std::vector<PresentationDataValue> gdcM::network::CEchoRQ::ConstructPDV (
    const ULConnection & inConnection,
    const BaseRootQuery * inRootQuery ) [override], [virtual]
```

Implements [gdcM::network::BaseCompositeMessage](#).

### 10.44.3 Member Data Documentation

#### 10.44.3.1 AffectedSOPClassUID

[UIComp](#) gdcM::network::CEchoRQ::AffectedSOPClassUID

#### 10.44.3.2 MessageID

uint16\_t gdcM::network::CEchoRQ::MessageID

The documentation for this class was generated from the following files:

- [gdcMCEchoMessages.h](#)
- [gdcMDIMSE.h](#)

## 10.45 gdcM::network::CEchoRSP Class Reference

[CEchoRSP](#) this file defines the messages for the cecho action.

```
#include <gdcMCEchoMessages.h>
```

Inheritance diagram for gdcM::network::CEchoRSP:

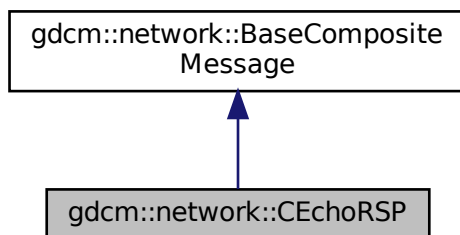

Collaboration diagram for gdcM::network::CEchoRSP:

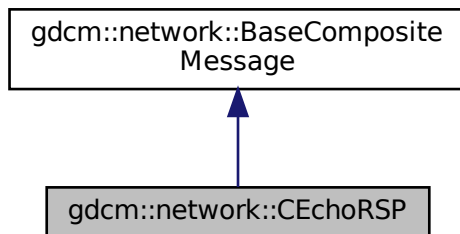

### Public Member Functions

- `std::vector< PresentationDataValue > ConstructPDVByDataSet (const DataSet *inDataSet)`

#### 10.45.1 Detailed Description

[CEchoRSP](#) this file defines the messages for the cecho action.

## 10.45.2 Member Function Documentation

### 10.45.2.1 ConstructPDVByDataSet()

```
std::vector<PresentationDataValue> gdcM::network::CEchoRSP::ConstructPDVByDataSet (
    const DataSet * inDataSet )
```

The documentation for this class was generated from the following file:

- [gdcMCEchoMessages.h](#)

## 10.46 gdcM::network::CFind Class Reference

```
#include <gdcMDIMSE.h>
```

### 10.46.1 Detailed Description

PS 3.4 - 2009 [Table B.2-1 C-STORE STATUS](#)

The documentation for this class was generated from the following file:

- [gdcMDIMSE.h](#)

## 10.47 gdcM::network::CFindCancelRQ Class Reference

[CFindCancelRQ](#) this file defines the messages for the cfind action.

```
#include <gdcMCFindMessages.h>
```

Inheritance diagram for gdcM::network::CFindCancelRQ:

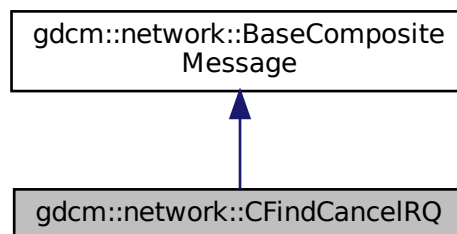

Collaboration diagram for gdcm::network::CFindCancelRQ:

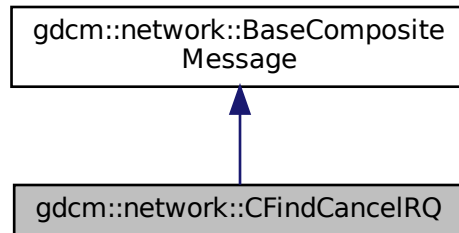

## Public Member Functions

- `std::vector< PresentationDataValue > ConstructPDVByDataSet` (const `DataSet *inDataSet`)

### 10.47.1 Detailed Description

[CFindCancelRQ](#) this file defines the messages for the cfind action.

### 10.47.2 Member Function Documentation

#### 10.47.2.1 ConstructPDVByDataSet()

```
std::vector<PresentationDataValue> gdcm::network::CFindCancelRQ::ConstructPDVByDataSet (
    const DataSet * inDataSet )
```

The documentation for this class was generated from the following file:

- [gdcmCFindMessages.h](#)

## 10.48 gdcm::network::CFindRQ Class Reference

[CFindRQ](#).

```
#include <gdcmCFindMessages.h>
```

Inheritance diagram for gdcm::network::CFindRQ:

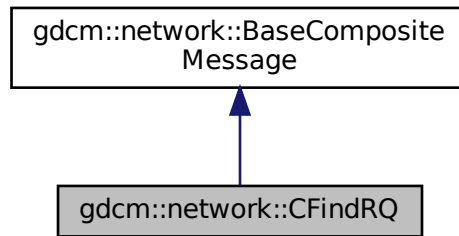

Collaboration diagram for gdcm::network::CFindRQ:

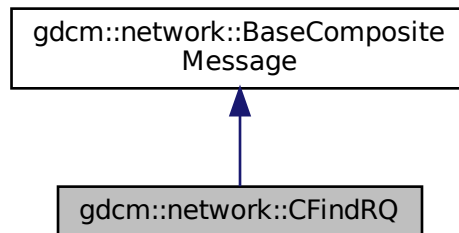

### Public Member Functions

- `std::vector< PresentationDataValue > ConstructPDV` (const [ULConnection](#) &inConnection, const [BaseRootQuery](#) \*inRootQuery) override

### 10.48.1 Detailed Description

[CFindRQ](#).

this file defines the messages for the cfind action

## 10.48.2 Member Function Documentation

### 10.48.2.1 ConstructPDV()

```
std::vector<PresentationDataValue> gdcm::network::CFindRQ::ConstructPDV (
    const ULConnection & inConnection,
    const BaseRootQuery * inRootQuery ) [override], [virtual]
```

Implements [gdcm::network::BaseCompositeMessage](#).

The documentation for this class was generated from the following file:

- [gdcmCFindMessages.h](#)

## 10.49 gdcm::network::CFindRSP Class Reference

[CFindRSP](#) this file defines the messages for the cfind action.

```
#include <gdcmCFindMessages.h>
```

Inheritance diagram for `gdcm::network::CFindRSP`:

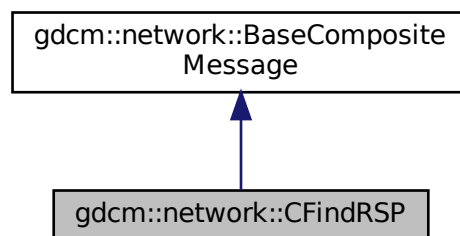

Collaboration diagram for `gdcm::network::CFindRSP`:

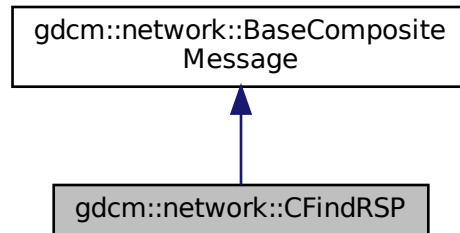

## Public Member Functions

- `std::vector< PresentationDataValue > ConstructPDVByDataSet` (`const DataSet *inDataSet`)

### 10.49.1 Detailed Description

[CFindRSP](#) this file defines the messages for the cfind action.

### 10.49.2 Member Function Documentation

#### 10.49.2.1 ConstructPDVByDataSet()

```
std::vector<PresentationDataValue> gdcm::network::CFindRSP::ConstructPDVByDataSet (
    const DataSet * inDataSet )
```

The documentation for this class was generated from the following file:

- [gdcmCFindMessages.h](#)



## 10.50 gdcM::network::CMoveCancelRq Class Reference

```
#include <gdcMCMoveMessages.h>
```

Inheritance diagram for gdcM::network::CMoveCancelRq:

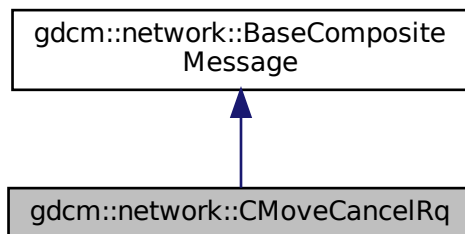

Collaboration diagram for gdcM::network::CMoveCancelRq:

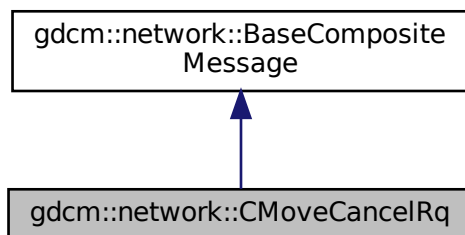

### Public Member Functions

- `std::vector< PresentationDataValue > ConstructPDVByDataSet` (const [DataSet](#) \*inDataSet)

### 10.50.1 Member Function Documentation

### 10.50.1.1 ConstructPDVByDataSet()

```
std::vector<PresentationDataValue> gdcM::network::CMoveCancelRq::ConstructPDVByDataSet (
    const DataSet * inDataSet )
```

The documentation for this class was generated from the following file:

- [gdcMCMoveMessages.h](#)

## 10.51 gdcM::network::CMoveRQ Class Reference

[CMoveRQ](#).

```
#include <gdcMCMoveMessages.h>
```

Inheritance diagram for gdcM::network::CMoveRQ:

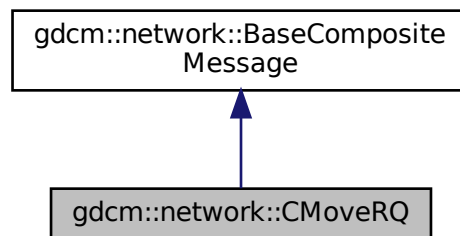

Collaboration diagram for gdcM::network::CMoveRQ:

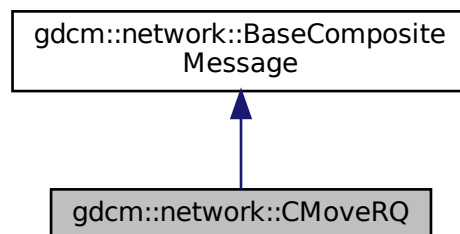

## Public Member Functions

- `std::vector< PresentationDataValue > ConstructPDV` (const [ULConnection](#) &*inConnection*, const [BaseRootQuery](#) \**inRootQuery*) override

### 10.51.1 Detailed Description

[CMoveRQ](#).

this file defines the messages for the cmove action

### 10.51.2 Member Function Documentation

#### 10.51.2.1 ConstructPDV()

```
std::vector<PresentationDataValue> gdcm::network::CMoveRQ::ConstructPDV (
    const ULConnection & inConnection,
    const BaseRootQuery * inRootQuery ) [override], [virtual]
```

Implements [gdcm::network::BaseCompositeMessage](#).

The documentation for this class was generated from the following file:

- [gdcmCMoveMessages.h](#)

## 10.52 gdcm::network::CMoveRSP Class Reference

[CMoveRSP](#) this file defines the messages for the cmove action.

```
#include <gdcmCMoveMessages.h>
```

Inheritance diagram for `gdcm::network::CMoveRSP`:

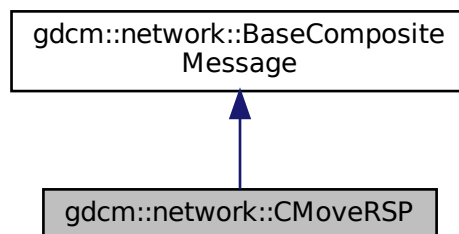

Collaboration diagram for `gdc::network::CMoveRSP`:

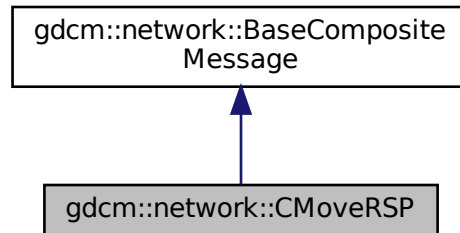

## Public Member Functions

- `std::vector< PresentationDataValue > ConstructPDVByDataSet (const DataSet *inDataSet)`

### 10.52.1 Detailed Description

[CMoveRSP](#) this file defines the messages for the cmove action.

### 10.52.2 Member Function Documentation

#### 10.52.2.1 ConstructPDVByDataSet()

```
std::vector<PresentationDataValue> gdc::network::CMoveRSP::ConstructPDVByDataSet (
    const DataSet * inDataSet )
```

The documentation for this class was generated from the following file:

- [gdcCMoveMessages.h](#)

## 10.53 gdcm::Codec Class Reference

[Codec](#) class.

```
#include <gdcmCodec.h>
```

Inheritance diagram for gdcm::Codec:

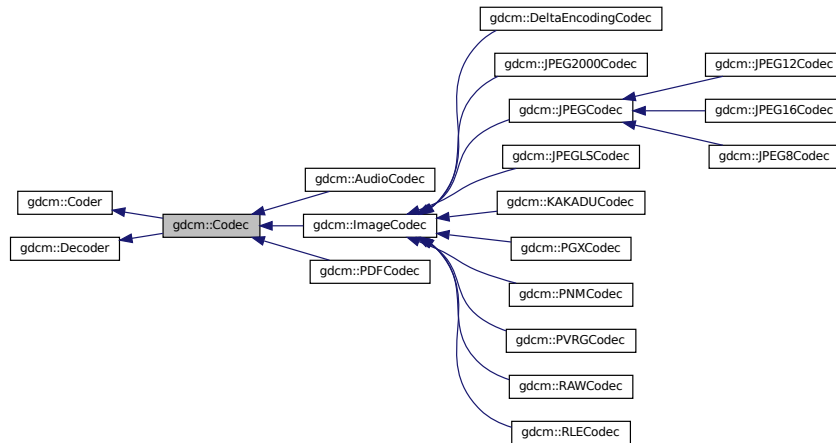

Collaboration diagram for gdcm::Codec:

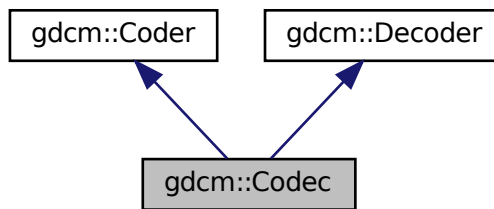

### Additional Inherited Members

#### 10.53.1 Detailed Description

[Codec](#) class.

The documentation for this class was generated from the following file:

- [gdcmCodec.h](#)

## 10.54 gdcm::Coder Class Reference

[Coder.](#)

```
#include <gdcmCoder.h>
```

Inheritance diagram for gdcm::Coder:

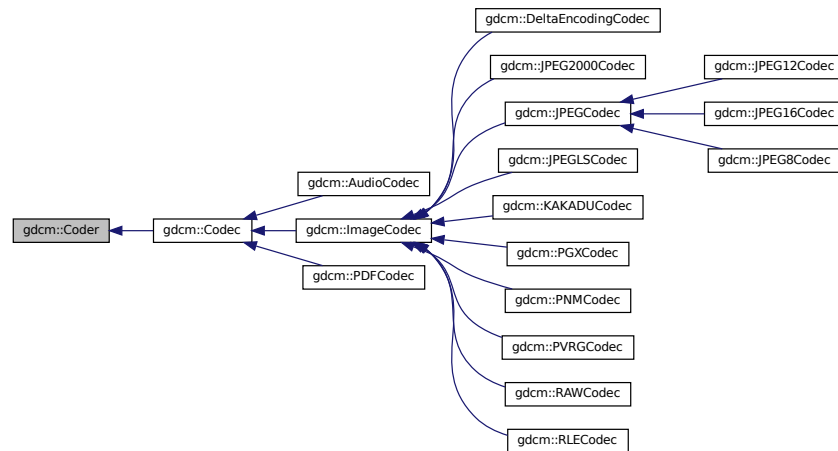

### Public Member Functions

- virtual `~Coder()`=default
- virtual bool `CanCode(TransferSyntax const &)` const =0  
*Return whether this coder support this transfer syntax (can code it)*
- virtual bool `Code(DataElement const &in_, DataElement &out_)`  
*Code.*

### Protected Member Functions

- virtual bool `InternalCode(const char *bv, unsigned long len, std::ostream &os)`

#### 10.54.1 Detailed Description

[Coder.](#)

#### 10.54.2 Constructor & Destructor Documentation

### 10.54.2.1 ~Coder()

```
virtual gdcm::Coder::~Coder ( ) [virtual], [default]
```

## 10.54.3 Member Function Documentation

### 10.54.3.1 CanCode()

```
virtual bool gdcm::Coder::CanCode (
    TransferSyntax const & ) const [pure virtual]
```

Return whether this coder support this transfer syntax (can code it)

Implemented in [gdcm::RLECodec](#), [gdcm::RAWCodec](#), [gdcm::PVRGCodec](#), [gdcm::PNMCodec](#), [gdcm::PGXCodec](#), [gdcm::KAKADUCodec](#), [gdcm::JPEGLSCodec](#), [gdcm::JPEGCodec](#), [gdcm::JPEG2000Codec](#), [gdcm::PDFCodec](#), [gdcm::ImageCodec](#), and [gdcm::AudioCodec](#).

### 10.54.3.2 Code()

```
virtual bool gdcm::Coder::Code (
    DataElement const & in_,
    DataElement & out_ ) [inline], [virtual]
```

Code.

Reimplemented in [gdcm::RLECodec](#), [gdcm::RAWCodec](#), [gdcm::PVRGCodec](#), [gdcm::KAKADUCodec](#), [gdcm::JPEGLSCodec](#), [gdcm::JPEGCodec](#), and [gdcm::JPEG2000Codec](#).

### 10.54.3.3 InternalCode()

```
virtual bool gdcm::Coder::InternalCode (
    const char * bv,
    unsigned long len,
    std::ostream & os ) [inline], [protected], [virtual]
```

Reimplemented in [gdcm::JPEG8Codec](#), [gdcm::JPEG16Codec](#), and [gdcm::JPEG12Codec](#).

The documentation for this class was generated from the following file:

- [gdcmCoder.h](#)

## 10.55 gdcm::CodeString Class Reference

[CodeString](#).

```
#include <gdcmCodeString.h>
```

### Public Types

- typedef [InternalClass::const\\_iterator](#) [const\\_iterator](#)
- typedef [InternalClass::const\\_reference](#) [const\\_reference](#)
- typedef [InternalClass::const\\_reverse\\_iterator](#) [const\\_reverse\\_iterator](#)
- typedef [InternalClass::difference\\_type](#) [difference\\_type](#)
- typedef [InternalClass::iterator](#) [iterator](#)
- typedef [InternalClass::pointer](#) [pointer](#)
- typedef [InternalClass::reference](#) [reference](#)
- typedef [InternalClass::reverse\\_iterator](#) [reverse\\_iterator](#)
- typedef [InternalClass::size\\_type](#) [size\\_type](#)
- typedef [InternalClass::value\\_type](#) [value\\_type](#)

### Public Member Functions

- [CodeString](#) ()  
*CodeString constructors.*
- [CodeString](#) (const [InternalClass](#) &s, [size\\_type](#) pos=0, [size\\_type](#) n=[InternalClass::npos](#))
- [CodeString](#) (const [value\\_type](#) \*s)
- [CodeString](#) (const [value\\_type](#) \*s, [size\\_type](#) n)
- [std::string](#) [GetAsString](#) () const  
*Return the full code string as std::string.*
- bool [IsValid](#) () const  
*Check if CodeString obj is correct..*
- [size\\_type](#) [Size](#) () const  
*Return the size of the string.*

### Protected Member Functions

- [std::string](#) [TrimInternal](#) () const

### Friends

- bool [operator!=](#) (const [CodeString](#) &ref, const [CodeString](#) &cs)
- [std::ostream](#) & [operator<<](#) ([std::ostream](#) &os, const [CodeString](#) &str)
- bool [operator==](#) (const [CodeString](#) &ref, const [CodeString](#) &cs)



## 10.55.1 Detailed Description

### [CodeString](#).

This is an implementation of DICOM [VR](#): CS The ctor will properly Trim so that operator== is correct.

#### Note

the ctor of [CodeString](#) will Trim the string on the fly so as to remove the extra leading and ending spaces. However it will not perform validation on the fly ([CodeString](#) obj can contains invalid char such as lower cases). This design was chosen to be a little tolerant to broken DICOM implementation, and thus allow user to compare lower case CS from there input file without the need to first rewrite them to get rid of invalid character (validation is a different operation from searching, querying).

#### Warning

when writing out DICOM file it is highly recommended to perform the [IsValid\(\)](#) call, at least to check that the length of the string match the definition in the standard.

## 10.55.2 Member Typedef Documentation

### 10.55.2.1 `const_iterator`

```
typedef InternalClass::const\_iterator gdcm::CodeString::const_iterator
```

### 10.55.2.2 `const_reference`

```
typedef InternalClass::const\_reference gdcm::CodeString::const_reference
```

### 10.55.2.3 `const_reverse_iterator`

```
typedef InternalClass::const\_reverse\_iterator gdcm::CodeString::const_reverse_iterator
```

### 10.55.2.4 `difference_type`

```
typedef InternalClass::difference\_type gdcm::CodeString::difference_type
```

#### 10.55.2.5 iterator

```
typedef InternalClass::iterator gdcM::CodeString::iterator
```

#### 10.55.2.6 pointer

```
typedef InternalClass::pointer gdcM::CodeString::pointer
```

#### 10.55.2.7 reference

```
typedef InternalClass::reference gdcM::CodeString::reference
```

#### 10.55.2.8 reverse\_iterator

```
typedef InternalClass::reverse_iterator gdcM::CodeString::reverse_iterator
```

#### 10.55.2.9 size\_type

```
typedef InternalClass::size_type gdcM::CodeString::size_type
```

#### 10.55.2.10 value\_type

```
typedef InternalClass::value_type gdcM::CodeString::value_type
```

### 10.55.3 Constructor & Destructor Documentation

### 10.55.3.1 CodeString() [1/4]

```
gdcM::CodeString::CodeString ( ) [inline]
```

[CodeString](#) constructors.

### 10.55.3.2 CodeString() [2/4]

```
gdcM::CodeString::CodeString (
    const value_type * s ) [inline]
```

### 10.55.3.3 CodeString() [3/4]

```
gdcM::CodeString::CodeString (
    const value_type * s,
    size_type n ) [inline]
```

### 10.55.3.4 CodeString() [4/4]

```
gdcM::CodeString::CodeString (
    const InternalClass & s,
    size_type pos = 0,
    size_type n = InternalClass::npos ) [inline]
```

## 10.55.4 Member Function Documentation

### 10.55.4.1 GetAsString()

```
std::string gdcM::CodeString::GetAsString ( ) const [inline]
```

Return the full code string as std::string.

#### 10.55.4.2 IsValid()

```
bool gdcM::CodeString::IsValid ( ) const
```

Check if [CodeString](#) obj is correct..

#### 10.55.4.3 Size()

```
size_type gdcM::CodeString::Size ( ) const [inline]
```

Return the size of the string.

#### 10.55.4.4 TrimInternal()

```
std::string gdcM::CodeString::TrimInternal ( ) const [inline], [protected]
```

### 10.55.5 Friends And Related Function Documentation

#### 10.55.5.1 operator"!=

```
bool operator!= (
    const CodeString & ref,
    const CodeString & cs ) [friend]
```

#### 10.55.5.2 operator<<

```
std::ostream& operator<< (
    std::ostream & os,
    const CodeString & str ) [friend]
```

### 10.55.5.3 operator==

```
bool operator== (
    const CodeString & ref,
    const CodeString & cs ) [friend]
```

The documentation for this class was generated from the following file:

- [gdcMCodeString.h](#)

## 10.56 gdcM::Command Class Reference

[Command](#) superclass for callback/observer methods.

```
#include <gdcMCommand.h>
```

Inheritance diagram for gdcM::Command:

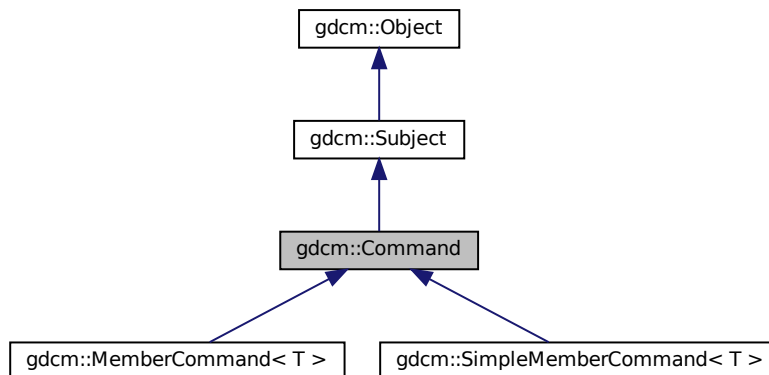

Collaboration diagram for `gdcm::Command`:

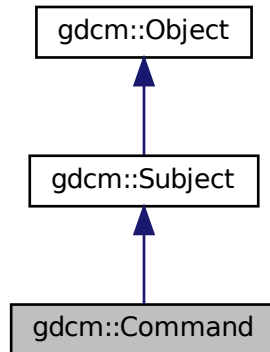

## Public Member Functions

- `Command` (const `Command` &)=delete
- virtual void `Execute` (const `Subject` \*caller, const `Event` &event)=0
- virtual void `Execute` (`Subject` \*caller, const `Event` &event)=0  
*Abstract method that defines the action to be taken by the command.*
- void `operator=` (const `Command` &)=delete

## Protected Member Functions

- `Command` ()
- `~Command` () override

### 10.56.1 Detailed Description

`Command` superclass for callback/observer methods.

See also

[Subject](#)

### 10.56.2 Constructor & Destructor Documentation

### 10.56.2.1 Command() [1/2]

```
gdcmm::Command::Command (
    const Command & ) [delete]
```

### 10.56.2.2 Command() [2/2]

```
gdcmm::Command::Command ( ) [protected]
```

### 10.56.2.3 ~Command()

```
gdcmm::Command::~~Command ( ) [override], [protected]
```

## 10.56.3 Member Function Documentation

### 10.56.3.1 Execute() [1/2]

```
virtual void gdcmm::Command::Execute (
    const Subject * caller,
    const Event & event ) [pure virtual]
```

Abstract method that defines the action to be taken by the command. This variant is expected to be used when requests comes from a const [Object](#)

Implemented in [gdcmm::MemberCommand< T >](#), and [gdcmm::SimpleMemberCommand< T >](#).

### 10.56.3.2 Execute() [2/2]

```
virtual void gdcmm::Command::Execute (
    Subject * caller,
    const Event & event ) [pure virtual]
```

Abstract method that defines the action to be taken by the command.

Implemented in [gdcmm::MemberCommand< T >](#), and [gdcmm::SimpleMemberCommand< T >](#).

### 10.56.3.3 operator=()

```
void gdcM::Command::operator= (
    const Command & ) [delete]
```

The documentation for this class was generated from the following file:

- [gdcMCommand.h](#)

## 10.57 gdcM::CommandDataSet Class Reference

Class to represent a [Command DataSet](#).

```
#include <gdcMCommandDataSet.h>
```

Inheritance diagram for gdcM::CommandDataSet:

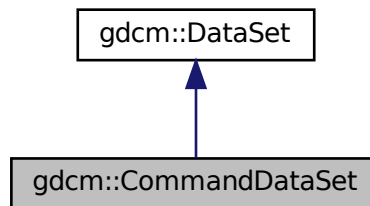

Collaboration diagram for gdcM::CommandDataSet:

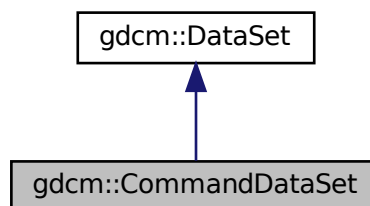



## Public Member Functions

- [CommandDataSet](#) ()=default
- [~CommandDataSet](#) ()=default
- void [Insert](#) (const [DataElement](#) &de)
- std::istream & [Read](#) (std::istream &is)  
*Read.*
- void [Replace](#) (const [DataElement](#) &de)
- std::ostream & [Write](#) (std::ostream &os) const  
*Write.*

## Friends

- std::ostream & [operator<<](#) (std::ostream &\_os, const [CommandDataSet](#) &\_val)

## Additional Inherited Members

### 10.57.1 Detailed Description

Class to represent a [Command DataSet](#).

See also

[DataSet](#)

### 10.57.2 Constructor & Destructor Documentation

#### 10.57.2.1 CommandDataSet()

```
gdcm::CommandDataSet::CommandDataSet ( ) [default]
```

#### 10.57.2.2 ~CommandDataSet()

```
gdcm::CommandDataSet::~~CommandDataSet ( ) [default]
```

### 10.57.3 Member Function Documentation

### 10.57.3.1 Insert()

```
void gdcM::CommandDataSet::Insert (
    const DataElement & de ) [inline]
```

References [gdcMErrorMacro](#), [gdcM::Tag::GetGroup\(\)](#), and [gdcM::DataElement::GetTag\(\)](#).

### 10.57.3.2 Read()

```
std::istream& gdcM::CommandDataSet::Read (
    std::istream & is )
```

Read.

### 10.57.3.3 Replace()

```
void gdcM::CommandDataSet::Replace (
    const DataElement & de ) [inline]
```

References [gdcM::DataElement::GetTag\(\)](#).

### 10.57.3.4 Write()

```
std::ostream& gdcM::CommandDataSet::Write (
    std::ostream & os ) const
```

Write.

## 10.57.4 Friends And Related Function Documentation

### 10.57.4.1 operator<<

```
std::ostream& operator<< (
    std::ostream & _os,
    const CommandDataSet & _val ) [friend]
```

The documentation for this class was generated from the following file:

- [gdcMCommandDataSet.h](#)

## 10.58 gdcM::network::CompositeMessageFactory Class Reference

[CompositeMessageFactory](#).

```
#include <gdcMCompositeMessageFactory.h>
```

### Static Public Member Functions

- static std::vector< [PresentationDataValue](#) > [ConstructCEchoRQ](#) (const [ULConnection](#) &inConnection)
- static std::vector< [PresentationDataValue](#) > [ConstructCFindRQ](#) (const [ULConnection](#) &inConnection, const [BaseRootQuery](#) \*inRootQuery)
- static std::vector< [PresentationDataValue](#) > [ConstructCMoveRQ](#) (const [ULConnection](#) &inConnection, const [BaseRootQuery](#) \*inRootQuery)
- static std::vector< [PresentationDataValue](#) > [ConstructCStoreRQ](#) (const [ULConnection](#) &inConnection, const [File](#) &file, bool writeDataSet=true)
- static std::vector< [PresentationDataValue](#) > [ConstructCStoreRSP](#) (const [DataSet](#) \*inDataSet, const [BasePDU](#) \*inPC)

### 10.58.1 Detailed Description

[CompositeMessageFactory](#).

This class constructs PDataPDUs, but that have been specifically constructed for the composite DICOM services (C-Echo, C-Find, C-Get, C-Move, and C-Store). It will also handle parsing the incoming data to determine which of the CompositePDUs the incoming data is, and so therefore allowing the scu to determine what to do with incoming data (if acting as a storescp server, for instance).

### 10.58.2 Member Function Documentation

#### 10.58.2.1 ConstructCEchoRQ()

```
static std::vector<PresentationDataValue> gdcM::network::CompositeMessageFactory::Construct←
CEchoRQ (
    const ULConnection & inConnection ) [static]
```

#### 10.58.2.2 ConstructCFindRQ()

```
static std::vector<PresentationDataValue> gdcM::network::CompositeMessageFactory::Construct←
CFindRQ (
    const ULConnection & inConnection,
    const BaseRootQuery * inRootQuery ) [static]
```

### 10.58.2.3 ConstructCMoveRQ()

```
static std::vector<PresentationDataValue> gdcM::network::CompositeMessageFactory::ConstructCMoveRQ (
    const ULConnection & inConnection,
    const BaseRootQuery * inRootQuery ) [static]
```

### 10.58.2.4 ConstructCStoreRQ()

```
static std::vector<PresentationDataValue> gdcM::network::CompositeMessageFactory::ConstructCStoreRQ (
    const ULConnection & inConnection,
    const File & file,
    bool writeDataSet = true ) [static]
```

### 10.58.2.5 ConstructCStoreRSP()

```
static std::vector<PresentationDataValue> gdcM::network::CompositeMessageFactory::ConstructCStoreRSP (
    const DataSet * inDataSet,
    const BasePDU * inPC ) [static]
```

The documentation for this class was generated from the following file:

- [gdcMCompositeMessageFactory.h](#)

## 10.59 gdcM::CompositeNetworkFunctions Class Reference

Composite Network Functions.

```
#include <gdcMCompositeNetworkFunctions.h>
```

### Public Types

- typedef std::vector< [KeyValuePairType](#) > [KeyValuePairArrayType](#)
- typedef std::pair< [Tag](#), std::string > [KeyValuePairType](#)

## Static Public Member Functions

- static bool [CEcho](#) (const char \*remote, uint16\_t portno, const char \*aetitle=nullptr, const char \*call=nullptr)
- static bool [CFind](#) (const char \*remote, uint16\_t portno, const [BaseRootQuery](#) \*query, std::vector< [DataSet](#) > &retDataSets, const char \*aetitle=nullptr, const char \*call=nullptr)
- static bool [CMove](#) (const char \*remote, uint16\_t portno, const [BaseRootQuery](#) \*query, uint16\_t portscp, const char \*aetitle=nullptr, const char \*call=nullptr, const char \*outputdir=nullptr)
- static [BaseRootQuery](#) \* [ConstructQuery](#) ([ERootType](#) inRootType, [EQueryLevel](#) inQueryLevel, const [DataSet](#) &queryds, [EQueryType](#) queryType=eFind)
- static [BaseRootQuery](#) \* [ConstructQuery](#) ([ERootType](#) inRootType, [EQueryLevel](#) inQueryLevel, const [KeyValuePairArrayType](#) &keys, [EQueryType](#) queryType=eFind)
- static bool [CStore](#) (const char \*remote, uint16\_t portno, const [Directory::FileNamesType](#) &filenames, const char \*aetitle=nullptr, const char \*call=nullptr)

### 10.59.1 Detailed Description

Composite Network Functions.

These functions provide a generic API to the DICOM functions implemented in GDCM. Advanced users can use this code as a template for building their own versions of these functions (for instance, to provide progress bars or some other way of handling returned query information), but for most users, these functions should be sufficient to interface with a PACS to a local machine. Note that these functions are not contained within a static class or some other class-style interface, because multiple connections can be instantiated in the same program. The DICOM standard is much more function oriented rather than class oriented in this instance, so the design of this API reflects that functional approach. These functions implements the following SCU operations:

- C-ECHO SCU
- C-FIND SCU
- C-STORE SCU
- C-MOVE SCU (+internal C-STORE SCP)

### 10.59.2 Member Typedef Documentation

#### 10.59.2.1 KeyValuePairArrayType

```
typedef std::vector< KeyValuePairType > gdcmm::CompositeNetworkFunctions::KeyValuePairArrayType
```

#### 10.59.2.2 KeyValuePairType

```
typedef std::pair<Tag, std::string> gdcmm::CompositeNetworkFunctions::KeyValuePairType
```

### 10.59.3 Member Function Documentation

#### 10.59.3.1 CEcho()

```
static bool gdcM::CompositeNetworkFunctions::CEcho (
    const char * remote,
    uint16_t portno,
    const char * aetitle = nullptr,
    const char * call = nullptr ) [static]
```

The most basic network function. Use this function to ensure that the remote server is responding on the given IP and port number as expected.

##### Parameters

<i>aetitle</i>	when not set will default to 'GDCMSCU'
<i>call</i>	when not set will default to 'ANY-SCP'

##### Warning

This is an error to set remote to NULL or portno to 0

##### Returns

true if it worked.

#### 10.59.3.2 CFind()

```
static bool gdcM::CompositeNetworkFunctions::CFind (
    const char * remote,
    uint16_t portno,
    const BaseRootQuery * query,
    std::vector< DataSet > & retDataSets,
    const char * aetitle = nullptr,
    const char * call = nullptr ) [static]
```

This function will use the provided query to determine what files a remote server contains that match the query strings. The return is a vector of datasets that contain tags as reported by the server. If the dataset is empty, then it is possible that an error condition was encountered; in which case, the user should monitor the error and warning streams.

##### Parameters

<i>aetitle</i>	when not set will default to 'GDCMSCU'
<i>call</i>	when not set will default to 'ANY-SCP'

**Warning**

This is an error to set remote to NULL or portno to 0

**Returns**

true if it worked.

**10.59.3.3 CMove()**

```
static bool gdcm::CompositeNetworkFunctions::CMove (
    const char * remote,
    uint16_t portno,
    const BaseRootQuery * query,
    uint16_t portscp,
    const char * aetitle = nullptr,
    const char * call = nullptr,
    const char * outputdir = nullptr ) [static]
```

This function will use the provided query to get files from a remote server. NOTE that this functionality is essentially equivalent to C-GET in the DICOM standard; however, C-GET has been deprecated, so this function allows for the user to ask a remote server for files matching a query and return them to the local machine. Files will be written to the given output directory. If the operation succeeds, the function returns true. This function is a prime candidate for being overwritten by expert users; if the datasets should remain in memory, for instance, that behavior can be changed by creating a user-level version of this function.

**Parameters**

<i>aetitle</i>	when not set will default to 'GDCMSCU'
<i>call</i>	when not set will default to 'ANY-SCP' This is an error to set remote to NULL or portno to 0 when
<i>outputdir</i>	is not set default to current dir ('.')

**Returns**

true if it worked.

**10.59.3.4 ConstructQuery() [1/2]**

```
static BaseRootQuery* gdcm::CompositeNetworkFunctions::ConstructQuery (
    ERootType inRootType,
    EQueryLevel inQueryLevel,
    const DataSet & queryds,
    EQueryType queryType = eFind ) [static]
```

This function will take a list of strings and tags and fill in a query that can be used for either CFind or CMove (depending on the input boolean

## Parameters

<i>inMove</i> ).	Note that the caller is responsible for deleting the constructed query. This function is used to build both a move and a find query (true for inMove if it's move, false if it's find)
------------------	--

**10.59.3.5 ConstructQuery()** [2/2]

```
static BaseRootQuery* gdcM::CompositeNetworkFunctions::ConstructQuery (
    ERootType inRootType,
    EQueryLevel inQueryLevel,
    const KeyValuePairArrayType & keys,
    EQueryType queryType = eFind ) [static]
```

**Deprecated****10.59.3.6 CStore()**

```
static bool gdcM::CompositeNetworkFunctions::CStore (
    const char * remote,
    uint16_t portno,
    const Directory::FileNamesType & filenames,
    const char * aetitle = nullptr,
    const char * call = nullptr ) [static]
```

This function will place the provided files into the remote server. The function returns true if it worked for all files.

**Warning**

the server side can refuse an association on a given file

## Parameters

<i>aetitle</i>	when not set will default to 'GDCMSCU'
<i>call</i>	when not set will default to 'ANY-SCP'

**Warning**

This is an error to set remote to NULL or portno to 0



**Returns**

true if it worked for all files

The documentation for this class was generated from the following file:

- [gdcmCompositeNetworkFunctions.h](#)

## 10.60 gdcm::ConstCharWrapper Class Reference

Do not use me.

```
#include <gdcmConstCharWrapper.h>
```

### Public Member Functions

- [ConstCharWrapper](#) (const char \*i=0)
- [operator const char \\* \(\)](#) const

#### 10.60.1 Detailed Description

Do not use me.

#### 10.60.2 Constructor & Destructor Documentation

##### 10.60.2.1 ConstCharWrapper()

```
gdcm::ConstCharWrapper::ConstCharWrapper (  
    const char * i = 0 ) [inline]
```

#### 10.60.3 Member Function Documentation

##### 10.60.3.1 operator const char \*()

```
gdcm::ConstCharWrapper::operator const char * ( ) const [inline]
```

The documentation for this class was generated from the following file:

- [gdcmConstCharWrapper.h](#)

## 10.61 gdcm::CP246ExplicitDataElement Class Reference

Class to read/write a [DataElement](#) as CP246Explicit Data [Element](#).

```
#include <gdcmCP246ExplicitDataElement.h>
```

Inheritance diagram for gdcm::CP246ExplicitDataElement:

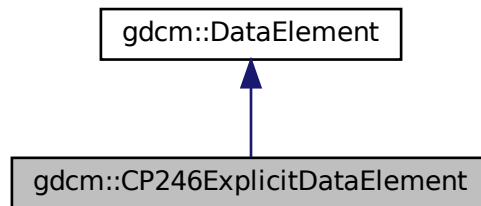

Collaboration diagram for gdcm::CP246ExplicitDataElement:

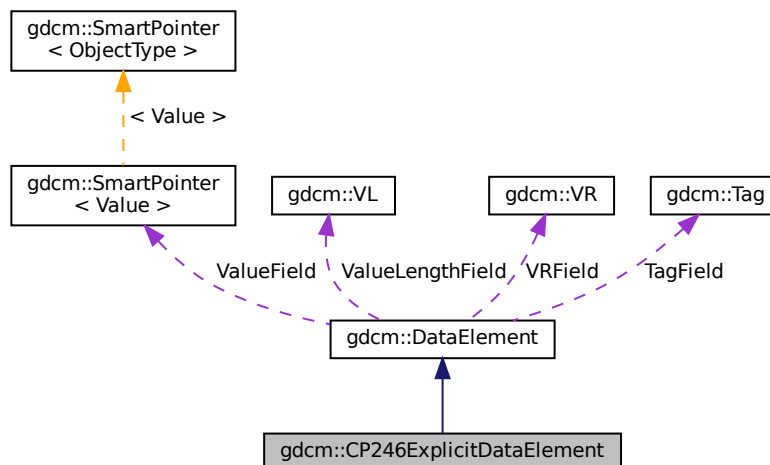

### Public Member Functions

- [VL GetLength](#) () const
- template<typename TSwap >  
std::istream & [Read](#) (std::istream &is)

- `template<typename TSwap >`  
`std::istream & ReadPreValue (std::istream &is)`
- `template<typename TSwap >`  
`std::istream & ReadValue (std::istream &is, bool readvalues=true)`
- `template<typename TSwap >`  
`std::istream & ReadWithLength (std::istream &is, VL &length)`

## Additional Inherited Members

### 10.61.1 Detailed Description

Class to read/write a [DataElement](#) as CP246Explicit Data [Element](#).

#### Note

Some system are producing SQ, declare them as UN, but encode the SQ as 'Explicit' instead of Implicit

### 10.61.2 Member Function Documentation

#### 10.61.2.1 GetLength()

```
VL gdcm::CP246ExplicitDataElement::GetLength ( ) const
```

#### 10.61.2.2 Read()

```
template<typename TSwap >  
std::istream& gdcm::CP246ExplicitDataElement::Read (  
    std::istream & is )
```

#### 10.61.2.3 ReadPreValue()

```
template<typename TSwap >  
std::istream& gdcm::CP246ExplicitDataElement::ReadPreValue (  
    std::istream & is )
```

### 10.61.2.4 ReadValue()

```
template<typename TSwap >
std::istream& gdcM::CP246ExplicitDataElement::ReadValue (
    std::istream & is,
    bool readvalues = true )
```

### 10.61.2.5 ReadWithLength()

```
template<typename TSwap >
std::istream& gdcM::CP246ExplicitDataElement::ReadWithLength (
    std::istream & is,
    VL & length )
```

The documentation for this class was generated from the following file:

- [gdcMCP246ExplicitDataElement.h](#)

## 10.62 gdcM::CryptoFactory Class Reference

Class to do handle the crypto factory.

```
#include <gdcMCryptoFactory.h>
```

Inheritance diagram for gdcM::CryptoFactory:

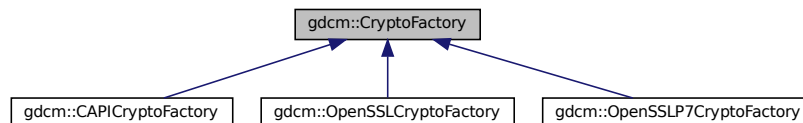

### Public Types

- enum `CryptoLib` {  
`DEFAULT = 0` ,  
`OPENSSL = 1` ,  
`CAPI = 2` ,  
`OPENSSL7 = 3` }

## Public Member Functions

- virtual [CryptographicMessageSyntax](#) \* [CreateCMSProvider](#) ()=0

## Static Public Member Functions

- static [CryptoFactory](#) \* [GetFactoryInstance](#) ([CryptoLib](#) id=DEFAULT)

## Protected Member Functions

- [CryptoFactory](#) ()=default
- [CryptoFactory](#) ([CryptoLib](#) id)
- [~CryptoFactory](#) ()=default

### 10.62.1 Detailed Description

Class to do handle the crypto factory.

GDCM needs to access in a platform independent way the user specified crypto engine. It can be:

- CAPI (windows only)
- OPENSSL (portable)
- OPENSSLP7 (portable) By default the factory will try: CAPI if on windows OPENSSL if possible OPENSSLP7 when older OpenSSL is used.

### 10.62.2 Member Enumeration Documentation

#### 10.62.2.1 CryptoLib

```
enum gdcmm::CryptoFactory::CryptoLib
```

Enumerator

DEFAULT	
OPENSSL	
CAPI	
OPENSSLP7	

## 10.62.3 Constructor & Destructor Documentation

### 10.62.3.1 CryptoFactory() [1/2]

```
gdcM::CryptoFactory::CryptoFactory (
    CryptoLib id ) [inline], [protected]
```

### 10.62.3.2 CryptoFactory() [2/2]

```
gdcM::CryptoFactory::CryptoFactory ( ) [protected], [default]
```

### 10.62.3.3 ~CryptoFactory()

```
gdcM::CryptoFactory::~~CryptoFactory ( ) [protected], [default]
```

## 10.62.4 Member Function Documentation

### 10.62.4.1 CreateCMSProvider()

```
virtual CryptographicMessageSyntax* gdcM::CryptoFactory::CreateCMSProvider ( ) [pure virtual]
```

Implemented in [gdcM::OpenSSLP7CryptoFactory](#), [gdcM::OpenSSLCryptoFactory](#), and [gdcM::CAPICryptoFactory](#).

### 10.62.4.2 GetFactoryInstance()

```
static CryptoFactory* gdcM::CryptoFactory::GetFactoryInstance (
    CryptoLib id = DEFAULT ) [static]
```

#### Examples

[BasicAnonymizer.cs](#), and [ClinicalTrialIdentificationWorkflow.cs](#).

The documentation for this class was generated from the following file:

- [gdcMCryptoFactory.h](#)

## 10.63 gdcM::CryptographicMessageSyntax Class Reference

```
#include <gdcMCryptographicMessageSyntax.h>
```

Inheritance diagram for gdcM::CryptographicMessageSyntax:

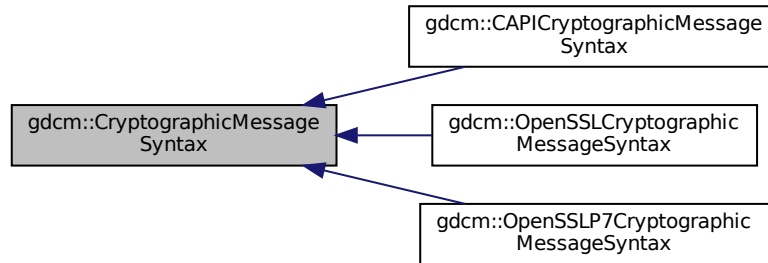

### Public Types

- enum [CipherTypes](#) {  
[DES3\\_CIPHER](#) ,  
[AES128\\_CIPHER](#) ,  
[AES192\\_CIPHER](#) ,  
[AES256\\_CIPHER](#) }

### Public Member Functions

- [CryptographicMessageSyntax](#) ()=default
- [CryptographicMessageSyntax](#) (const [CryptographicMessageSyntax](#) &)=delete
- virtual [~CryptographicMessageSyntax](#) ()=default
- virtual bool [Decrypt](#) (char \*output, size\_t &outlen, const char \*array, size\_t len) const =0  
*decrypt content from a CMS envelopedData structure*
- virtual bool [Encrypt](#) (char \*output, size\_t &outlen, const char \*array, size\_t len) const =0  
*create a CMS envelopedData structure*
- virtual [CipherTypes](#) [GetCipherType](#) () const =0
- void [operator=](#) (const [CryptographicMessageSyntax](#) &)=delete
- virtual bool [ParseCertificateFile](#) (const char \*filename)=0
- virtual bool [ParseKeyFile](#) (const char \*filename)=0
- virtual void [SetCipherType](#) ([CipherTypes](#) type)=0
- virtual bool [SetPassword](#) (const char \*pass, size\_t passLen)=0

### 10.63.1 Member Enumeration Documentation

#### 10.63.1.1 CipherTypes

```
enum gdcM::CryptographicMessageSyntax::CipherTypes
```

## Enumerator

DES3_CIPHER	
AES128_CIPHER	
AES192_CIPHER	
AES256_CIPHER	

## 10.63.2 Constructor & Destructor Documentation

### 10.63.2.1 CryptographicMessageSyntax() [1/2]

```
gdcM::CryptographicMessageSyntax::CryptographicMessageSyntax ( ) [default]
```

### 10.63.2.2 ~CryptographicMessageSyntax()

```
virtual gdcM::CryptographicMessageSyntax::~~CryptographicMessageSyntax ( ) [virtual], [default]
```

### 10.63.2.3 CryptographicMessageSyntax() [2/2]

```
gdcM::CryptographicMessageSyntax::CryptographicMessageSyntax (
    const CryptographicMessageSyntax & ) [delete]
```

## 10.63.3 Member Function Documentation

### 10.63.3.1 Decrypt()

```
virtual bool gdcM::CryptographicMessageSyntax::Decrypt (
    char * output,
    size_t & outlen,
    const char * array,
    size_t len ) const [pure virtual]
```

decrypt content from a CMS envelopedData structure

Implemented in [gdcM::OpenSSLP7CryptographicMessageSyntax](#), [gdcM::OpenSSLCryptographicMessageSyntax](#), and [gdcM::CAPICryptographicMessageSyntax](#).



### 10.63.3.2 Encrypt()

```
virtual bool gdcM::CryptographicMessageSyntax::Encrypt (
    char * output,
    size_t & outlen,
    const char * array,
    size_t len ) const [pure virtual]
```

create a CMS envelopedData structure

Implemented in [gdcM::OpenSSLP7CryptographicMessageSyntax](#), [gdcM::OpenSSLCryptographicMessageSyntax](#), and [gdcM::CAPICryptographicMessageSyntax](#).

### 10.63.3.3 GetCipherType()

```
virtual CipherTypes gdcM::CryptographicMessageSyntax::GetCipherType ( ) const [pure virtual]
```

Implemented in [gdcM::OpenSSLP7CryptographicMessageSyntax](#), [gdcM::OpenSSLCryptographicMessageSyntax](#), and [gdcM::CAPICryptographicMessageSyntax](#).

### 10.63.3.4 operator=()

```
void gdcM::CryptographicMessageSyntax::operator= (
    const CryptographicMessageSyntax & ) [delete]
```

### 10.63.3.5 ParseCertificateFile()

```
virtual bool gdcM::CryptographicMessageSyntax::ParseCertificateFile (
    const char * filename ) [pure virtual]
```

Implemented in [gdcM::OpenSSLP7CryptographicMessageSyntax](#), [gdcM::OpenSSLCryptographicMessageSyntax](#), and [gdcM::CAPICryptographicMessageSyntax](#).

### 10.63.3.6 ParseKeyFile()

```
virtual bool gdcM::CryptographicMessageSyntax::ParseKeyFile (
    const char * filename ) [pure virtual]
```

Implemented in [gdcM::OpenSSLP7CryptographicMessageSyntax](#), [gdcM::OpenSSLCryptographicMessageSyntax](#), and [gdcM::CAPICryptographicMessageSyntax](#).

### 10.63.3.7 SetCipherType()

```
virtual void gdcM::CryptographicMessageSyntax::SetCipherType (
    CipherTypes type ) [pure virtual]
```

Implemented in [gdcM::OpenSSLP7CryptographicMessageSyntax](#), [gdcM::OpenSSLCryptographicMessageSyntax](#), and [gdcM::CAPICryptographicMessageSyntax](#).

### 10.63.3.8 SetPassword()

```
virtual bool gdcM::CryptographicMessageSyntax::SetPassword (
    const char * pass,
    size_t passLen ) [pure virtual]
```

Implemented in [gdcM::OpenSSLCryptographicMessageSyntax](#), [gdcM::CAPICryptographicMessageSyntax](#), and [gdcM::OpenSSLP7CryptographicMessageSyntax](#).

The documentation for this class was generated from the following file:

- [gdcMCryptographicMessageSyntax.h](#)

## 10.64 gdcM::CSAElement Class Reference

Class to represent a CSA [Element](#).

```
#include <gdcMCSAElement.h>
```

Collaboration diagram for gdcM::CSAElement:

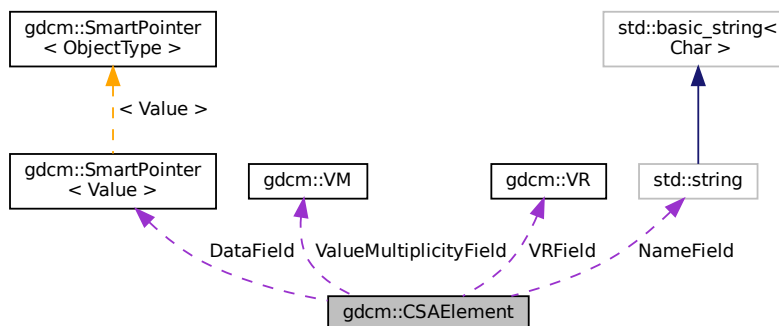

## Public Member Functions

- [CSAElement](#) (const [CSAElement](#) &\_val)
- [CSAElement](#) (unsigned int kf=0)
- const [ByteValue](#) \* [GetByteValue](#) () const
- unsigned int [GetKey](#) () const  
*Set/Get Key.*
- const char \* [GetName](#) () const  
*Set/Get Name.*
- unsigned int [GetNoOfItems](#) () const  
*Set/Get NoOfItems.*
- unsigned int [GetSyngoDT](#) () const  
*Set/Get SyngoDT.*
- [Value](#) & [GetValue](#) ()
- [Value](#) const & [GetValue](#) () const  
*Set/Get Value (bytes array, SQ of items, SQ of fragments):*
- const [VM](#) & [GetVM](#) () const  
*Set/Get VM.*
- [VR](#) const & [GetVR](#) () const  
*Set/Get VR.*
- bool [IsEmpty](#) () const  
*Check if CSA Element is empty.*
- bool [operator<](#) (const [CSAElement](#) &de) const
- [CSAElement](#) & [operator=](#) (const [CSAElement](#) &de)=default
- bool [operator==](#) (const [CSAElement](#) &de) const
- void [SetByteValue](#) (const char \*array, [VL](#) length)  
*Set.*
- void [SetKey](#) (unsigned int key)
- void [SetName](#) (const char \*name)
- void [SetNoOfItems](#) (unsigned int items)
- void [SetSyngoDT](#) (unsigned int syngodt)
- void [SetValue](#) ([Value](#) const &vl)
- void [SetVM](#) (const [VM](#) &vm)
- void [SetVR](#) ([VR](#) const &vr)

## Protected Types

- typedef [SmartPointer](#)< [Value](#) > [DataPtr](#)

## Protected Attributes

- [DataPtr](#) [DataField](#)
- unsigned int [KeyField](#)
- std::string [NameField](#)
- unsigned int [NoOfItemsField](#)
- unsigned int [SyngoDTField](#)
- [VM](#) [ValueMultiplicityField](#)
- [VR](#) [VRField](#)

## Friends

- `std::ostream & operator<<` (`std::ostream &os, const CSAElement &val`)

### 10.64.1 Detailed Description

Class to represent a CSA [Element](#).

See also

[CSAHeader](#)

Examples

[DumpSiemensBase64.cxx](#), [MrProtocol.cxx](#), and [csa2img.cxx](#).

### 10.64.2 Member Typedef Documentation

#### 10.64.2.1 DataPtr

```
typedef SmartPointer<Value> gdcm::CSAElement::DataPtr [protected]
```

### 10.64.3 Constructor & Destructor Documentation

#### 10.64.3.1 CSAElement() [1/2]

```
gdcm::CSAElement::CSAElement (  
    unsigned int kf = 0 ) [inline]
```

#### 10.64.3.2 CSAElement() [2/2]

```
gdcm::CSAElement::CSAElement (  
    const CSAElement & _val ) [inline]
```

## 10.64.4 Member Function Documentation

### 10.64.4.1 GetByteValue()

```
const ByteValue* gdcM::CSAElement::GetByteValue ( ) const [inline]
```

Return the [Value](#) of [CSAElement](#) as a [ByteValue](#) (if possible)

#### Warning

: You need to check for NULL return value

#### Examples

[DumpSiemensBase64.cxx](#), and [MrProtocol.cxx](#).

### 10.64.4.2 GetKey()

```
unsigned int gdcM::CSAElement::GetKey ( ) const [inline]
```

Set/Get Key.

Referenced by operator<().

### 10.64.4.3 GetName()

```
const char* gdcM::CSAElement::GetName ( ) const [inline]
```

Set/Get Name.

### 10.64.4.4 GetNoOfItems()

```
unsigned int gdcM::CSAElement::GetNoOfItems ( ) const [inline]
```

Set/Get NoOfItems.

#### 10.64.4.5 GetSyngoDT()

```
unsigned int gdcm::CSAElement::GetSyngoDT ( ) const [inline]
```

Set/Get SyngoDT.

#### 10.64.4.6 GetValue() [1/2]

```
Value& gdcm::CSAElement::GetValue ( ) [inline]
```

#### 10.64.4.7 GetValue() [2/2]

```
Value const& gdcm::CSAElement::GetValue ( ) const [inline]
```

Set/Get [Value](#) (bytes array, SQ of items, SQ of fragments):

#### Examples

[csa2img.cxx](#).

#### 10.64.4.8 GetVM()

```
const VM& gdcm::CSAElement::GetVM ( ) const [inline]
```

Set/Get [VM](#).

#### 10.64.4.9 GetVR()

```
VR const& gdcm::CSAElement::GetVR ( ) const [inline]
```

Set/Get [VR](#).

#### 10.64.4.10 IsEmpty()

```
bool gdcm::CSAElement::IsEmpty ( ) const [inline]
```

Check if CSA [Element](#) is empty.

#### Examples

[csa2img.cxx](#).

#### 10.64.4.11 operator<()

```
bool gdcm::CSAElement::operator< (
    const CSAElement & de ) const [inline]
```

References [GetKey\(\)](#).

#### 10.64.4.12 operator=()

```
CSAElement& gdcm::CSAElement::operator= (
    const CSAElement & de ) [default]
```

#### 10.64.4.13 operator==( )

```
bool gdcm::CSAElement::operator==(
    const CSAElement & de ) const [inline]
```

References [KeyField](#), [NameField](#), [SyngoDTField](#), [ValueMultiplicityField](#), and [VRField](#).

#### 10.64.4.14 SetByteValue()

```
void gdcm::CSAElement::SetByteValue (
    const char * array,
    VL length ) [inline]
```

Set.

**10.64.4.15 SetKey()**

```
void gdcM::CSAElement::SetKey (
    unsigned int key ) [inline]
```

**10.64.4.16 SetName()**

```
void gdcM::CSAElement::SetName (
    const char * name ) [inline]
```

**10.64.4.17 SetNoOfItems()**

```
void gdcM::CSAElement::SetNoOfItems (
    unsigned int items ) [inline]
```

**10.64.4.18 SetSyngoDT()**

```
void gdcM::CSAElement::SetSyngoDT (
    unsigned int syngodt ) [inline]
```

**10.64.4.19 SetValue()**

```
void gdcM::CSAElement::SetValue (
    Value const & vl ) [inline]
```

**10.64.4.20 SetVM()**

```
void gdcM::CSAElement::SetVM (
    const VM & vm ) [inline]
```



#### 10.64.4.21 SetVR()

```
void gdcM::CSAElement::SetVR (
    VR const & vr ) [inline]
```

### 10.64.5 Friends And Related Function Documentation

#### 10.64.5.1 operator<<

```
std::ostream& operator<< (
    std::ostream & os,
    const CSAElement & val ) [friend]
```

### 10.64.6 Member Data Documentation

#### 10.64.6.1 DataField

```
DataPtr gdcM::CSAElement::DataField [protected]
```

#### 10.64.6.2 KeyField

```
unsigned int gdcM::CSAElement::KeyField [protected]
```

Referenced by operator==().

#### 10.64.6.3 NameField

```
std::string gdcM::CSAElement::NameField [protected]
```

Referenced by operator==().

#### 10.64.6.4 NoOfItemsField

```
unsigned int gdcm::CSAElement::NoOfItemsField [protected]
```

#### 10.64.6.5 SyngoDTField

```
unsigned int gdcm::CSAElement::SyngoDTField [protected]
```

Referenced by operator==().

#### 10.64.6.6 ValueMultiplicityField

```
VM gdcm::CSAElement::ValueMultiplicityField [protected]
```

Referenced by operator==().

#### 10.64.6.7 VRField

```
VR gdcm::CSAElement::VRField [protected]
```

Referenced by operator==().

The documentation for this class was generated from the following file:

- [gdcmCSAElement.h](#)

## 10.65 gdcm::CSAHeader Class Reference

Class for [CSAHeader](#).

```
#include <gdcmCSAHeader.h>
```

### Public Types

- enum [CSAHeaderType](#) {  
    [UNKNOWN](#) = 0 ,  
    [SV10](#) ,  
    [NOMAGIC](#) ,  
    [DATASET\\_FORMAT](#) ,  
    [INTERFILE](#) ,  
    [ZEROED\\_OUT](#) }

*Divers format of [CSAHeader](#) as found 'in the wild'.*

## Public Member Functions

- [CSAHeader](#) ()
- [~CSAHeader](#) ()=default
- bool [FindCSAElementByName](#) (const char \*name)
- const [CSAElement](#) & [GetCSAElementByName](#) (const char \*name)
- const [DataSet](#) & [GetDataSet](#) () const  
*Return the [DataSet](#) output (use only if Format == DATASET\_FORMAT)*
- [CSAHeaderType](#) [GetFormat](#) () const
- const char \* [GetInterfile](#) () const  
*Return the string output (use only if Format == Interfile)*
- bool [GetMrProtocol](#) (const [DataSet](#) &ds, [MrProtocol](#) &mrProtocol)  
*Retrieve the ASCII portion stored within the MrProtocol/MrPhoenixProtocol:*
- bool [LoadFromDataElement](#) ([DataElement](#) const &de)  
*Decode the [CSAHeader](#) from element 'de'.*
- void [Print](#) (std::ostream &os) const  
*Print the [CSAHeader](#) (use only if Format == SV10 or NOMAGIC)*

## Static Public Member Functions

- static const [PrivateTag](#) & [GetCSADataInfo](#) ()
- static const [PrivateTag](#) & [GetCSAImageHeaderInfoTag](#) ()
- static const [PrivateTag](#) & [GetCSASeriesHeaderInfoTag](#) ()

## Protected Member Functions

- const [CSAElement](#) & [GetCSAEEnd](#) () const

## Friends

- std::ostream & [operator<<](#) (std::ostream &\_os, const [CSAHeader](#) &d)

### 10.65.1 Detailed Description

Class for [CSAHeader](#).

SIEMENS store private information in tag (0x0029,0x10,"SIEMENS CSA HEADER") this class is meant for user wishing to access values stored within this private attribute. There are basically two main 'format' for this attribute : SV10/↔ NOMAGIC and DATASET\_FORMAT SV10 and NOMAGIC are from a user prospective identical, see [CSAHeader.xml](#) for possible name / value stored in this format. DATASET\_FORMAT is in fact simply just another DICOM dataset (implicit) with -currently unknown- value. This can be only be printed for now.

**Warning**

Everything you do with this code is at your own risk, since decoding process was not written from specification documents.

the API of this class might change.

**Todo** MrEvaProtocol in 29,1020 contains ^M that would be nice to get rid of on UNIX system...

**See also**

[PDBHeader](#)

External references: 5.1.3.2.4.1 MEDCOM History Information and 5.1.4.3 CSA Non-Image [Module](#) in [http://tamsinfo.toshiba.com/docrequest/pdf/E.Soft\\_v2.0.pdf](http://tamsinfo.toshiba.com/docrequest/pdf/E.Soft_v2.0.pdf)

**Examples**

[DumpSiemensBase64.cxx](#), [MrProtocol.cxx](#), and [csa2img.cxx](#).

**10.65.2 Member Enumeration Documentation****10.65.2.1 CSAHeaderType**

enum [gdcm::CSAHeader::CSAHeaderType](#)

Divers format of [CSAHeader](#) as found 'in the wild'.

**Enumerator**

UNKNOWN	
SV10	
NOMAGIC	
DATASET_FORMAT	
INTERFILE	
ZEROED_OUT	

**10.65.3 Constructor & Destructor Documentation**

### 10.65.3.1 CSAHeader()

```
gdcm::CSAHeader::CSAHeader ( ) [inline]
```

### 10.65.3.2 ~CSAHeader()

```
gdcm::CSAHeader::~~CSAHeader ( ) [default]
```

## 10.65.4 Member Function Documentation

### 10.65.4.1 FindCSAElementByName()

```
bool gdcm::CSAHeader::FindCSAElementByName (
    const char * name )
```

Return true if the CSA element matching 'name' is found or not

#### Warning

Case Sensitive

#### Examples

[DumpSiemensBase64.cxx](#), [MrProtocol.cxx](#), and [csa2img.cxx](#).

### 10.65.4.2 GetCSADataInfo()

```
static const PrivateTag& gdcm::CSAHeader::GetCSADataInfo ( ) [static]
```

Return the private tag used by SIEMENS to store the CSA Data Info This is: [PrivateTag\(0x0029,0x0010,"SIEMENS CSA NON-IMAGE"\)](#);

### 10.65.4.3 GetCSAEEnd()

```
const CSAElement& gdcm::CSAHeader::GetCSAEEnd ( ) const [protected]
```

#### 10.65.4.4 GetCSAElementByName()

```
const CSAElement& gdcm::CSAHeader::GetCSAElementByName (
    const char * name )
```

Return the [CSAElement](#) corresponding to name 'name'

##### Warning

Case Sensitive

##### Examples

[DumpSiemensBase64.cxx](#), [MrProtocol.cxx](#), and [csa2img.cxx](#).

#### 10.65.4.5 GetCSAImageHeaderInfoTag()

```
static const PrivateTag& gdcm::CSAHeader::GetCSAImageHeaderInfoTag ( ) [static]
```

Return the private tag used by SIEMENS to store the CSA [Image](#) Header This is: [PrivateTag](#)(0x0029,0x0010,"SIEMENS CSA HEADER");

##### Examples

[DumpSiemensBase64.cxx](#), [PublicDict.cxx](#), and [csa2img.cxx](#).

#### 10.65.4.6 GetCSASeriesHeaderInfoTag()

```
static const PrivateTag& gdcm::CSAHeader::GetCSASeriesHeaderInfoTag ( ) [static]
```

Return the private tag used by SIEMENS to store the CSA [Series](#) Header This is: [PrivateTag](#)(0x0029,0x0020,"SIEMENS CSA HEADER");

##### Examples

[MrProtocol.cxx](#).

#### 10.65.4.7 GetDataSet()

```
const DataSet& gdcm::CSAHeader::GetDataSet ( ) const [inline]
```

Return the [DataSet](#) output (use only if Format == DATASET\_FORMAT )

#### 10.65.4.8 GetFormat()

```
CSAHeaderType gdcm::CSAHeader::GetFormat ( ) const
```

return the format of the [CSAHeader](#) SV10 and NOMAGIC are equivalent.

#### 10.65.4.9 GetInterfile()

```
const char* gdcm::CSAHeader::GetInterfile ( ) const [inline]
```

Return the string output (use only if Format == Interfile)

#### 10.65.4.10 GetMrProtocol()

```
bool gdcm::CSAHeader::GetMrProtocol (
    const DataSet & ds,
    MrProtocol & mrProtocol )
```

Retrieve the ASCII portion stored within the MrProtocol/MrPhoenixProtocol:

##### Examples

[MrProtocol.cxx](#).

#### 10.65.4.11 LoadFromDataElement()

```
bool gdcm::CSAHeader::LoadFromDataElement (
    DataElement const & de )
```

Decode the [CSAHeader](#) from element 'de'.

##### Examples

[DumpSiemensBase64.cxx](#), [MrProtocol.cxx](#), and [csa2img.cxx](#).

### 10.65.4.12 Print()

```
void gdcM::CSAHeader::Print (
    std::ostream & os ) const
```

Print the [CSAHeader](#) (use only if Format == SV10 or NOMAGIC)

#### Examples

[csa2img.cxx](#).

## 10.65.5 Friends And Related Function Documentation

### 10.65.5.1 operator<<

```
std::ostream& operator<< (
    std::ostream & _os,
    const CSAHeader & d ) [friend]
```

The documentation for this class was generated from the following file:

- [gdcMCSAHeader.h](#)

## 10.66 gdcM::CSAHeaderDict Class Reference

Class to represent a map of [CSAHeaderDictEntry](#).

```
#include <gdcMCSAHeaderDict.h>
```

### Public Types

- typedef MapCSAHeaderDictEntry::const\_iterator [ConstIterator](#)
- typedef MapCSAHeaderDictEntry::iterator [Iterator](#)
- typedef std::set< [CSAHeaderDictEntry](#) > [MapCSAHeaderDictEntry](#)

### Public Member Functions

- [CSAHeaderDict](#) ()
- [CSAHeaderDict](#) (const [CSAHeaderDict](#) &\_val)=delete
- void [AddCSAHeaderDictEntry](#) (const [CSAHeaderDictEntry](#) &de)
- [ConstIterator](#) [Begin](#) () const
- [ConstIterator](#) [End](#) () const
- const [CSAHeaderDictEntry](#) & [GetCSAHeaderDictEntry](#) (const char \*name) const
- bool [IsEmpty](#) () const
- [CSAHeaderDict](#) & [operator=](#) (const [CSAHeaderDict](#) &\_val)=delete



## Protected Member Functions

- void [LoadDefault](#) ()

## Friends

- class [Dicts](#)
- `std::ostream & operator<<` (`std::ostream &_os`, `const CSAHeaderDict &_val`)

### 10.66.1 Detailed Description

Class to represent a map of [CSAHeaderDictEntry](#).

Examples

[MrProtocol.cxx](#).

### 10.66.2 Member Typedef Documentation

#### 10.66.2.1 ConstIterator

```
typedef MapCSAHeaderDictEntry::const_iterator gdcmm::CSAHeaderDict::ConstIterator
```

#### 10.66.2.2 Iterator

```
typedef MapCSAHeaderDictEntry::iterator gdcmm::CSAHeaderDict::Iterator
```

#### 10.66.2.3 MapCSAHeaderDictEntry

```
typedef std::set<CSAHeaderDictEntry> gdcmm::CSAHeaderDict::MapCSAHeaderDictEntry
```

### 10.66.3 Constructor & Destructor Documentation

### 10.66.3.1 CSAHeaderDict() [1/2]

```
gdcM::CSAHeaderDict::CSAHeaderDict ( ) [inline]
```

### 10.66.3.2 CSAHeaderDict() [2/2]

```
gdcM::CSAHeaderDict::CSAHeaderDict (
    const CSAHeaderDict & _val ) [delete]
```

## 10.66.4 Member Function Documentation

### 10.66.4.1 AddCSAHeaderDictEntry()

```
void gdcM::CSAHeaderDict::AddCSAHeaderDictEntry (
    const CSAHeaderDictEntry & de ) [inline]
```

### 10.66.4.2 Begin()

```
ConstIterator gdcM::CSAHeaderDict::Begin ( ) const [inline]
```

### 10.66.4.3 End()

```
ConstIterator gdcM::CSAHeaderDict::End ( ) const [inline]
```

### 10.66.4.4 GetCSAHeaderDictEntry()

```
const CSAHeaderDictEntry& gdcM::CSAHeaderDict::GetCSAHeaderDictEntry (
    const char * name ) const [inline]
```

## Examples

[MrProtocol.cxx](#).

#### 10.66.4.5 IsEmpty()

```
bool gdcm::CSAHeaderDict::IsEmpty ( ) const [inline]
```

#### 10.66.4.6 LoadDefault()

```
void gdcm::CSAHeaderDict::LoadDefault ( ) [protected]
```

#### 10.66.4.7 operator=()

```
CSAHeaderDict& gdcm::CSAHeaderDict::operator= (
    const CSAHeaderDict & _val ) [delete]
```

### 10.66.5 Friends And Related Function Documentation

#### 10.66.5.1 Dicts

```
friend class Dicts [friend]
```

#### 10.66.5.2 operator<<

```
std::ostream& operator<< (
    std::ostream & _os,
    const CSAHeaderDict & _val ) [friend]
```

The documentation for this class was generated from the following file:

- [gdcmCSAHeaderDict.h](#)

## 10.67 gdcm::CSAHeaderDictEntry Class Reference

Class to represent an Entry in the [Dict](#).

```
#include <gdcmCSAHeaderDictEntry.h>
```

## Public Member Functions

- [CSAHeaderDictEntry](#) (const char \*name="", [VR](#) const &vr=[VR::INVALID](#), [VM](#) const &vm=[VM::VM0](#), const char \*desc="")
- const char \* [GetDescription](#) () const  
*Set/Get Description.*
- const char \* [GetName](#) () const  
*Set/Get Name.*
- const [VM](#) & [GetVM](#) () const  
*Set/Get VM.*
- const [VR](#) & [GetVR](#) () const  
*Set/Get VR.*
- bool [operator<](#) (const [CSAHeaderDictEntry](#) &entry) const
- void [SetDescription](#) (const char \*desc)
- void [SetName](#) (const char \*name)
- void [SetVM](#) ([VM](#) const &vm)
- void [SetVR](#) (const [VR](#) &vr)

## Friends

- std::ostream & [operator<<](#) (std::ostream &\_os, const [CSAHeaderDictEntry](#) &\_val)

### 10.67.1 Detailed Description

Class to represent an Entry in the [Dict](#).

Does not really exist within the DICOM definition, just a way to minimize storage and have a mapping from [gdcm::Tag](#) to the needed information

#### Note

bla TODO FIXME: Need a PublicCSAHeaderDictEntry...indeed [CSAHeaderDictEntry](#) has a notion of retired which does not exist in PrivateCSAHeaderDictEntry...

#### See also

[gdcm::Dict](#)

#### Examples

[MrProtocol.cxx](#).

### 10.67.2 Constructor & Destructor Documentation

### 10.67.2.1 CSAHeaderDictEntry()

```
gdcm::CSAHeaderDictEntry::CSAHeaderDictEntry (
    const char * name = "",
    VR const & vr = VR::INVALID,
    VM const & vm = VM::VMO,
    const char * desc = "" ) [inline]
```

## 10.67.3 Member Function Documentation

### 10.67.3.1 GetDescription()

```
const char* gdcm::CSAHeaderDictEntry::GetDescription ( ) const [inline]
```

Set/Get Description.

### 10.67.3.2 GetName()

```
const char* gdcm::CSAHeaderDictEntry::GetName ( ) const [inline]
```

Set/Get Name.

Referenced by operator<().

### 10.67.3.3 GetVM()

```
const VM& gdcm::CSAHeaderDictEntry::GetVM ( ) const [inline]
```

Set/Get VM.

### 10.67.3.4 GetVR()

```
const VR& gdcm::CSAHeaderDictEntry::GetVR ( ) const [inline]
```

Set/Get VR.

### 10.67.3.5 operator<()

```
bool gdcm::CSAHeaderDictEntry::operator< (
    const CSAHeaderDictEntry & entry ) const [inline]
```

References GetName().

### 10.67.3.6 SetDescription()

```
void gdcm::CSAHeaderDictEntry::SetDescription (
    const char * desc ) [inline]
```

### 10.67.3.7 SetName()

```
void gdcm::CSAHeaderDictEntry::SetName (
    const char * name ) [inline]
```

### 10.67.3.8 SetVM()

```
void gdcm::CSAHeaderDictEntry::SetVM (
    VM const & vm ) [inline]
```

### 10.67.3.9 SetVR()

```
void gdcm::CSAHeaderDictEntry::SetVR (
    const VR & vr ) [inline]
```

## 10.67.4 Friends And Related Function Documentation

### 10.67.4.1 operator<<

```
std::ostream& operator<< (  
    std::ostream & _os,  
    const CSAHeaderDictEntry & _val ) [friend]
```

The documentation for this class was generated from the following file:

- [gdcmCSAHeaderDictEntry.h](#)

## 10.68 gdcm::CSAHeaderDictException Class Reference

```
#include <gdcmCSAHeaderDict.h>
```

Inheritance diagram for gdcm::CSAHeaderDictException:

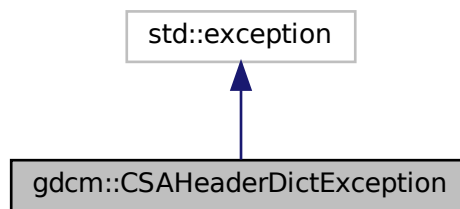

Collaboration diagram for gdcm::CSAHeaderDictException:

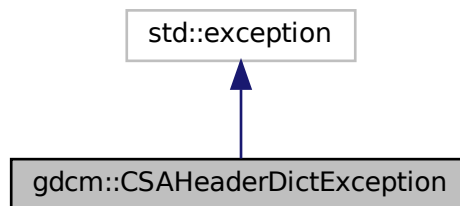

The documentation for this class was generated from the following file:

- [gdcmCSAHeaderDict.h](#)

## 10.69 gdcM::network::CStoreRQ Class Reference

[CStoreRQ](#).

```
#include <gdcMStoreMessages.h>
```

Inheritance diagram for gdcM::network::CStoreRQ:

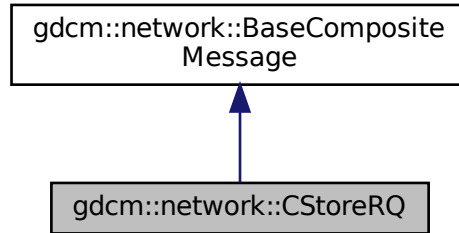

Collaboration diagram for gdcM::network::CStoreRQ:

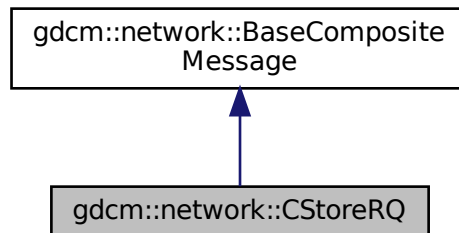

### Public Member Functions

- `std::vector< PresentationDataValue > ConstructPDV` (const [ULConnection](#) &inConnection, const [File](#) &file, bool writeDataSet=true)

### 10.69.1 Detailed Description

[CStoreRQ](#).

this file defines the messages for the cecho action



## 10.69.2 Member Function Documentation

### 10.69.2.1 ConstructPDV()

```
std::vector<PresentationDataValue> gdcm::network::CStoreRQ::ConstructPDV (
    const ULConnection & inConnection,
    const File & file,
    bool writeDataSet = true )
```

The documentation for this class was generated from the following file:

- [gdcmCStoreMessages.h](#)

## 10.70 gdcm::network::CStoreRSP Class Reference

[CStoreRSP](#) this file defines the messages for the cecho action.

```
#include <gdcmCStoreMessages.h>
```

Inheritance diagram for gdcm::network::CStoreRSP:

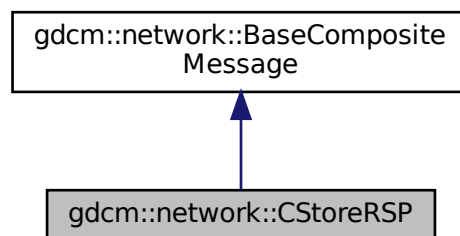

Collaboration diagram for `gdcm::network::CStoreRSP`:

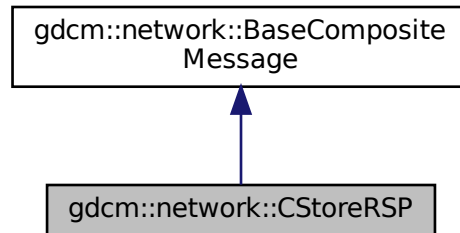

## Public Member Functions

- `std::vector< PresentationDataValue > ConstructPDV` (const [DataSet](#) \*inDataSet, const [BasePDU](#) \*inPC)

### 10.70.1 Detailed Description

[CStoreRSP](#) this file defines the messages for the cecho action.

### 10.70.2 Member Function Documentation

#### 10.70.2.1 ConstructPDV()

```
std::vector<PresentationDataValue> gdcm::network::CStoreRSP::ConstructPDV (
    const DataSet * inDataSet,
    const BasePDU * inPC )
```

The documentation for this class was generated from the following file:

- [gdcmCStoreMessages.h](#)

## 10.71 gdcm::Curve Class Reference

[Curve](#) class to handle element 50xx,3000 [Curve](#) Data.

```
#include <gdcmCurve.h>
```

Inheritance diagram for gdcm::Curve:

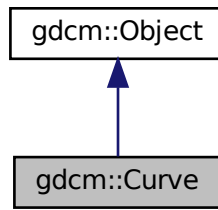

Collaboration diagram for gdcm::Curve:

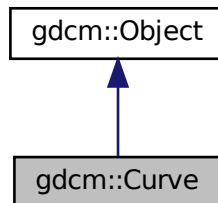

### Public Member Functions

- [Curve](#) ()
- [Curve](#) ([Curve](#) const &ov)
- [~Curve](#) () override
- void [Decode](#) (std::istream &is, std::ostream &os)
- void [GetAsPoints](#) (float \*array) const
- std::vector< unsigned short > const & [GetCurveDataDescriptor](#) () const
- unsigned short [GetDataValueRepresentation](#) () const
- unsigned short [GetDimensions](#) () const

- unsigned short [GetGroup](#) () const
- unsigned short [GetNumberOfPoints](#) () const
- const char \* [GetTypeOfData](#) () const
- const char \* [GetTypeOfDataDescription](#) () const
- bool [IsEmpty](#) () const
- void [Print](#) (std::ostream &) const override
- void [SetCoordinateStartValue](#) (unsigned short v)
- void [SetCoordinateStepValue](#) (unsigned short v)
- void [SetCurve](#) (const char \*array, unsigned int length)
- void [SetCurveDataDescriptor](#) (const uint16\_t \*values, size\_t num)
- void [SetCurveDescription](#) (const char \*curvedescription)
- void [SetDataValueRepresentation](#) (unsigned short datavaluerepresentation)
- void [SetDimensions](#) (unsigned short dimensions)
- void [SetGroup](#) (unsigned short group)
- void [SetNumberOfPoints](#) (unsigned short numberofpoints)
- void [SetTypeOfData](#) (const char \*typeofdata)
- void [Update](#) (const [DataElement](#) &de)

## Static Public Member Functions

- static unsigned int [GetNumberOfCurves](#) ([DataSet](#) const &ds)

## Additional Inherited Members

### 10.71.1 Detailed Description

[Curve](#) class to handle element 50xx,3000 [Curve](#) Data.

WARNING: This is deprecated and lastly defined in PS 3.3 - 2004

Examples:

- GE\_DLX-8-MONO2-Multiframe-Jpeg\_Lossless.dcm
- GE\_DLX-8-MONO2-Multiframe.dcm
- gdcmsampleData/Philips\_Medical\_Images/integriss\_HV\_5000/xa\_integriss.dcm
- TOSHIBA-CurveData[1-3].dcm

### 10.71.2 Constructor & Destructor Documentation

### 10.71.2.1 Curve() [1/2]

```
gdcm::Curve::Curve ( )
```

### 10.71.2.2 ~Curve()

```
gdcm::Curve::~~Curve ( ) [override]
```

### 10.71.2.3 Curve() [2/2]

```
gdcm::Curve::Curve (
    Curve const & ov )
```

## 10.71.3 Member Function Documentation

### 10.71.3.1 Decode()

```
void gdcm::Curve::Decode (
    std::istream & is,
    std::ostream & os )
```

### 10.71.3.2 GetAsPoints()

```
void gdcm::Curve::GetAsPoints (
    float * array ) const
```

### 10.71.3.3 GetCurveDataDescriptor()

```
std::vector<unsigned short> const& gdcm::Curve::GetCurveDataDescriptor ( ) const
```

#### 10.71.3.4 GetDataValueRepresentation()

```
unsigned short gdcM::Curve::GetDataValueRepresentation ( ) const
```

#### 10.71.3.5 GetDimensions()

```
unsigned short gdcM::Curve::GetDimensions ( ) const
```

#### 10.71.3.6 GetGroup()

```
unsigned short gdcM::Curve::GetGroup ( ) const
```

#### 10.71.3.7 GetNumberOfCurves()

```
static unsigned int gdcM::Curve::GetNumberOfCurves (
    DataSet const & ds ) [static]
```

#### 10.71.3.8 GetNumberOfPoints()

```
unsigned short gdcM::Curve::GetNumberOfPoints ( ) const
```

#### 10.71.3.9 GetTypeOfData()

```
const char* gdcM::Curve::GetTypeOfData ( ) const
```

#### 10.71.3.10 GetTypeOfDataDescription()

```
const char* gdcM::Curve::GetTypeOfDataDescription ( ) const
```

### 10.71.3.11 IsEmpty()

```
bool gdcm::Curve::IsEmpty ( ) const
```

### 10.71.3.12 Print()

```
void gdcm::Curve::Print (
    std::ostream & ) const [override], [virtual]
```

Reimplemented from [gdcm::Object](#).

### 10.71.3.13 SetCoordinateStartValue()

```
void gdcm::Curve::SetCoordinateStartValue (
    unsigned short v )
```

### 10.71.3.14 SetCoordinateStepValue()

```
void gdcm::Curve::SetCoordinateStepValue (
    unsigned short v )
```

### 10.71.3.15 SetCurve()

```
void gdcm::Curve::SetCurve (
    const char * array,
    unsigned int length )
```

### 10.71.3.16 SetCurveDataDescriptor()

```
void gdcm::Curve::SetCurveDataDescriptor (
    const uint16_t * values,
    size_t num )
```

**10.71.3.17 SetCurveDescription()**

```
void gdcM::Curve::SetCurveDescription (
    const char * curvedescription )
```

**10.71.3.18 SetDataValueRepresentation()**

```
void gdcM::Curve::SetDataValueRepresentation (
    unsigned short datavaluerepresentation )
```

**10.71.3.19 SetDimensions()**

```
void gdcM::Curve::SetDimensions (
    unsigned short dimensions )
```

**10.71.3.20 SetGroup()**

```
void gdcM::Curve::SetGroup (
    unsigned short group )
```

**10.71.3.21 SetNumberOfPoints()**

```
void gdcM::Curve::SetNumberOfPoints (
    unsigned short numberofpoints )
```

**10.71.3.22 SetTypeOfData()**

```
void gdcM::Curve::SetTypeOfData (
    const char * typeofdata )
```



### 10.71.3.23 Update()

```
void gdcM::Curve::Update (
    const DataElement & de )
```

The documentation for this class was generated from the following file:

- [gdcMCurve.h](#)

## 10.72 gdcM::DataElement Class Reference

Class to represent a Data [Element](#) either Implicit or Explicit.

```
#include <gdcMDataElement.h>
```

Inheritance diagram for gdcM::DataElement:

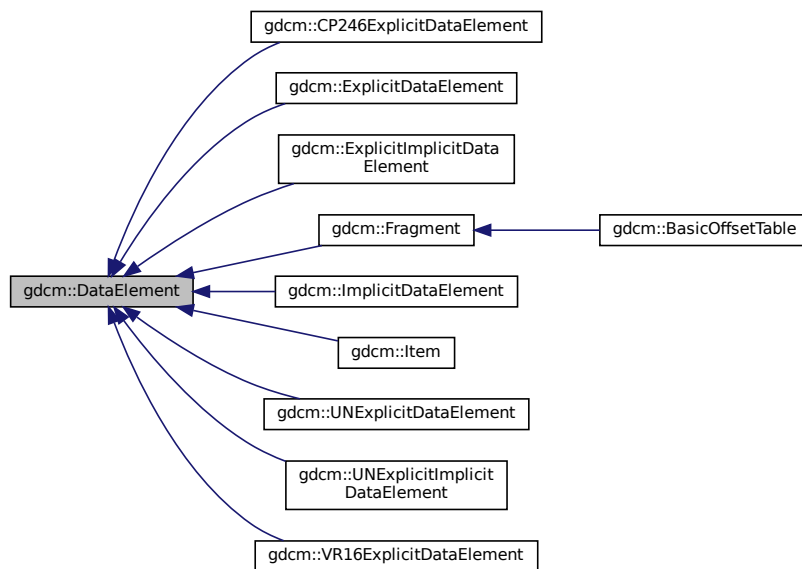

Collaboration diagram for `gdcm::DataElement`:

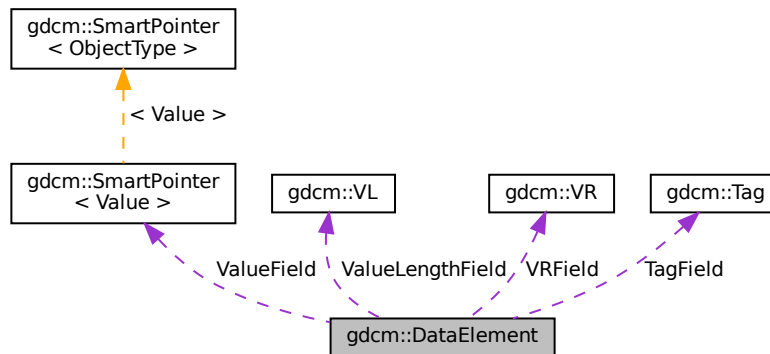

## Public Member Functions

- `DataElement` (const `DataElement` &\_val)
- `DataElement` (const `Tag` &t=`Tag`(0), const `VL` &vl=0, const `VR` &vr=`VR::INVALID`)
- void `Clear` ()
  - Clear Data Element (make Value empty and invalidate Tag & VR)*
- void `Empty` ()
  - Make Data Element empty (no Value)*
- const `ByteValue` \* `GetByteValue` () const
- template<typename TDE >
  - `VL` `GetLength` () const
- `SequenceOfFragments` \* `GetSequenceOfFragments` ()
- const `SequenceOfFragments` \* `GetSequenceOfFragments` () const
- `Tag` & `GetTag` ()
- const `Tag` & `GetTag` () const
  - Get Tag.*
- `Value` & `GetValue` ()
- `Value` const & `GetValue` () const
  - Set/Get Value (bytes array, SQ of items, SQ of fragments):*
- `SmartPointer`< `SequenceOfItems` > `GetValueAsSQ` () const
- `VL` & `GetVL` ()
- const `VL` & `GetVL` () const
  - Get VL.*
- `VR` const & `GetVR` () const
- bool `IsEmpty` () const
  - Check if Data Element is empty.*
- bool `IsUndefinedLength` () const
  - return if Value Length if of undefined length*
- bool `operator<` (const `DataElement` &de) const
- `DataElement` & `operator=` (const `DataElement` &)=default

- bool [operator==](#) (const [DataElement](#) &de) const
- template<typename TDE , typename TSwap >  
std::istream & [Read](#) (std::istream &is)
- template<typename TDE , typename TSwap >  
std::istream & [ReadOrSkip](#) (std::istream &is, std::set< [Tag](#) > const &skiptags)
- template<typename TDE , typename TSwap >  
std::istream & [ReadPreValue](#) (std::istream &is, std::set< [Tag](#) > const &skiptags)
- template<typename TDE , typename TSwap >  
std::istream & [ReadValue](#) (std::istream &is, std::set< [Tag](#) > const &skiptags)
- template<typename TDE , typename TSwap >  
std::istream & [ReadValueWithLength](#) (std::istream &is, [VL](#) &length, std::set< [Tag](#) > const &skiptags)
- template<typename TDE , typename TSwap >  
std::istream & [ReadWithLength](#) (std::istream &is, [VL](#) &length)
- void [SetByteValue](#) (const char \*array, [VL](#) length)
- void [SetTag](#) (const [Tag](#) &t)
- void [SetValue](#) ([Value](#) const &vl)
- void [SetVL](#) (const [VL](#) &vl)
- void [SetVLToUndefined](#) ()
- void [SetVR](#) ([VR](#) const &vr)
- template<typename TDE , typename TSwap >  
const std::ostream & [Write](#) (std::ostream &os) const

## Protected Types

- typedef [SmartPointer](#)< [Value](#) > [ValuePtr](#)

## Protected Member Functions

- void [SetValueFieldLength](#) ([VL](#) vl, bool readvalues)

## Protected Attributes

- [Tag](#) [TagField](#)
- [ValuePtr](#) [ValueField](#)
- [VL](#) [ValueLengthField](#)
- [VR](#) [VRField](#)

## Friends

- std::ostream & [operator<<](#) (std::ostream &\_os, const [DataElement](#) &\_val)

## 10.72.1 Detailed Description

Class to represent a Data [Element](#) either Implicit or Explicit.

DATA ELEMENT: A unit of information as defined by a single entry in the data dictionary. An encoded Information [Object Definition \(IOD\) Attribute](#) that is composed of, at a minimum, three fields: a Data [Element Tag](#), a [Value Length](#), and a [Value Field](#). For some specific Transfer Syntaxes, a Data [Element](#) also contains a [VR Field](#) where the [Value Representation](#) of that Data [Element](#) is specified explicitly.

Design:

- A [DataElement](#) in GDCM always store [VL \(Value Length\)](#) on a 32 bits integer even when [VL](#) is 16 bits
- A [DataElement](#) always store the [VR](#) even for Implicit TS, in which case [VR](#) is defaulted to [VR::INVALID](#)
- For [Item](#) start/end (See 0xfffe tags), [Value](#) is NULL

See also

[ExplicitDataElement](#) [ImplicitDataElement](#)

Examples

[ChangePrivateTags.cxx](#), [ChangeSequenceUltrasound.cxx](#), [CreateARGBImage.cxx](#), [CreateCMYKImage.cxx](#), [DiffFile.cxx](#), [DumpADAC.cxx](#), [DumpExamCard.cxx](#), [DumpGEMSMovieGroup.cxx](#), [DumpImageHeaderInfo.cxx](#), [DumpSiemensBase64.cxx](#), [DumpToshibaDTI.cxx](#), [DumpToshibaDTI2.cxx](#), [DumpVisusChange.cxx](#), [DuplicatePCDE.cxx](#), [ELSCINT1WaveToText.cxx](#), [ExtractEncryptedContent.cxx](#), [ExtractIconFromFile.cxx](#), [Extracting\\_All\\_Resolution.cxx](#), [Fake\\_Image\\_Using\\_Stream\\_Image\\_Writer.cxx](#), [FixBrokenJ2K.cxx](#), [FixJAIBugJPEGLS.cxx](#), [GenAllVR.cxx](#), [GenFakelIdentifyFile.cxx](#), [GenFakelImage.cxx](#), [GenLongSeqs.cxx](#), [GenSeqs.cxx](#), [GetJPEGSamplePrecision.cxx](#), [GetSequenceUltrasound.cxx](#), [GetSubSequenceData.cxx](#), [LargeVRDSExplicit.cxx](#), [ReadAndDumpDICOMDIR.cxx](#), [StreamImageReaderTest.cxx](#), [csa2img.cxx](#), [gdcmrtonplan.cxx](#), [gdcmrtpian.cxx](#), [iU22tomultisc.cxx](#), [pmsct\\_rgb1.cxx](#), and [rle2img.cxx](#).

## 10.72.2 Member Typedef Documentation

### 10.72.2.1 ValuePtr

```
typedef SmartPointer<Value> gdcm::DataElement::ValuePtr [protected]
```

## 10.72.3 Constructor & Destructor Documentation

### 10.72.3.1 DataElement() [1/2]

```
gdcm::DataElement::DataElement (
    const Tag & t = Tag(0),
    const VL & vl = 0,
    const VR & vr = VR::INVALID ) [inline]
```

### 10.72.3.2 DataElement() [2/2]

```
gdcm::DataElement::DataElement (
    const DataElement & _val ) [inline]
```

## 10.72.4 Member Function Documentation

### 10.72.4.1 Clear()

```
void gdcm::DataElement::Clear ( ) [inline]
```

Clear Data [Element](#) (make [Value](#) empty and invalidate [Tag](#) & [VR](#))

### 10.72.4.2 Empty()

```
void gdcm::DataElement::Empty ( ) [inline]
```

Make Data [Element](#) empty (no [Value](#))

### 10.72.4.3 GetByteValue()

```
const ByteValue* gdcm::DataElement::GetByteValue ( ) const [inline]
```

Return the [Value](#) of [DataElement](#) as a [ByteValue](#) (if possible)

#### Warning

: You need to check for NULL return value

#### Examples

[DumpADAC.cxx](#), [DumpExamCard.cxx](#), [DumpGEMSMovieGroup.cxx](#), [DumpImageHeaderInfo.cxx](#), [DumpToshibaDTI.cxx](#), [DumpToshibaDTI2.cxx](#), [DuplicatePCDE.cxx](#), [ELSCINT1WaveToText.cxx](#), [ExtractEncryptedContent.cxx](#), [ExtractIconFromFile.cxx](#), [FixBrokenJ2K.cxx](#), [FixJAIBugJPEGLS.cxx](#), [PatchFile.cxx](#), [ReadExplicitLengthSQIVR.cxx](#), [pmsct\\_rgb1.cxx](#), and [rle2img.cxx](#).

Referenced by [gdcm::Attribute< Group, Element, TVR, TVM >::SetFromDataElement\(\)](#), [gdcm::Attribute< Group, Element, TVR, VM::VM1 >::SetFromDataElement\(\)](#), [gdcm::Attribute< Group, Element, TVR, VM::VM1\\_n >::SetFromDataElement\(\)](#), [gdcm::Element< TVR, TVM >::SetFromDataElement\(\)](#), and [gdcm::Element< TVR, VM::VM1\\_n >::SetFromDataElement\(\)](#).

#### 10.72.4.4 GetLength()

```
template<typename TDE >
VL gdcM::DataElement::GetLength ( ) const [inline]
```

#### 10.72.4.5 GetSequenceOfFragments() [1/2]

```
SequenceOfFragments* gdcM::DataElement::GetSequenceOfFragments ( )
```

#### 10.72.4.6 GetSequenceOfFragments() [2/2]

```
const SequenceOfFragments* gdcM::DataElement::GetSequenceOfFragments ( ) const
```

Return the [Value](#) of [DataElement](#) as a Sequence Of Fragments (if possible)

#### Warning

: You need to check for NULL return value

#### Examples

[FixBrokenJ2K.cxx](#), [FixJAIBugJPEGLS.cxx](#), and [GetJPEGSamplePrecision.cxx](#).

#### 10.72.4.7 GetTag() [1/2]

```
Tag& gdcM::DataElement::GetTag ( ) [inline]
```

#### 10.72.4.8 GetTag() [2/2]

```
const Tag& gdcM::DataElement::GetTag ( ) const [inline]
```

Get [Tag](#).

#### Examples

[DumpGEMSMovieGroup.cxx](#), [DuplicatePCDE.cxx](#), and [pmsct\\_rgb1.cxx](#).

Referenced by [gdcM::DataSet::Insert\(\)](#), [gdcM::FileMetaInformation::Insert\(\)](#), [gdcM::CommandDataSet::Insert\(\)](#), [operator<\(\)](#), [gdcM::SequenceOfItems::Read\(\)](#), [gdcM::SequenceOfFragments::ReadValue\(\)](#), [gdcM::FileMetaInformation::Replace\(\)](#), [gdcM::CommandDataSet::Replace\(\)](#), [gdcM::Attribute< Group, Element, TVR, TVM >::SetFromDataElement\(\)](#), [gdcM::Attribute< Group, Element, TVR, VM::VM1 >::SetFromDataElement\(\)](#), and [gdcM::Attribute< Group, Element, TVR, VM::VM1\\_n >::SetFromDataElement\(\)](#).

### 10.72.4.9 GetValue() [1/2]

```
Value& gdcmm::DataElement::GetValue ( ) [inline]
```

References [gdcmmAssertAlwaysMacro](#).

### 10.72.4.10 GetValue() [2/2]

```
Value const& gdcmm::DataElement::GetValue ( ) const [inline]
```

Set/Get [Value](#) (bytes array, SQ of items, SQ of fragments):

#### Examples

[ReadAndDumpDICOMDIR.cxx](#).

References [gdcmmAssertAlwaysMacro](#).

Referenced by [gdcmm::DataSet::InsertDataElement\(\)](#), [gdcmm::Element< TVR, TVM >::SetFromDataElement\(\)](#), and [gdcmm::Element< TVR, VM::VM1\\_n >::SetFromDataElement\(\)](#).

### 10.72.4.11 GetValueAsSQ()

```
SmartPointer<SequenceOfItems> gdcmm::DataElement::GetValueAsSQ ( ) const
```

Interpret the [Value](#) stored in the [DataElement](#). This is more robust (but also more expensive) to call this function rather than the simplest form: [GetSequenceOfItems\(\)](#) It also return NULL when the [Value](#) is NOT of type [SequenceOfItems](#)

#### Warning

in case [GetSequenceOfItems\(\)](#) succeed the function return this value, otherwise it creates a new [SequenceOfItems](#), you should handle that in your case, for instance: `SmartPointer<SequenceOfItems> sqi = de.GetValueAsSQ();`

#### Examples

[ChangeSequenceUltrasound.cxx](#), [DumpExamCard.cxx](#), [DumpGEMSMovieGroup.cxx](#), [DumpPhilipsECHO.cxx](#), [DumpToshibaDTI.cxx](#), [DumpToshibaDTI2.cxx](#), [DumpVisusChange.cxx](#), [ExtractEncryptedContent.cxx](#), [GetSequenceUltrasound.cxx](#), [GetSubSequenceData.cxx](#), [LargeVRDSExplicit.cxx](#), [ReadAndDumpDICOMDIR.cxx](#), [gdcmmrtionplan.cxx](#), and [gdcmmrtplan.cxx](#).

**10.72.4.12 GetVL()** [1/2]

```
VL& gdcM::DataElement::GetVL ( ) [inline]
```

**10.72.4.13 GetVL()** [2/2]

```
const VL& gdcM::DataElement::GetVL ( ) const [inline]
```

Get [VL](#).

Referenced by [gdcM::DataSet::InsertDataElement\(\)](#), [gdcM::SequenceOfItems::Read\(\)](#), and [gdcM::SequenceOfFragments::ReadValue\(\)](#).

**10.72.4.14 GetVR()**

```
VR const& gdcM::DataElement::GetVR ( ) const [inline]
```

Get [VR](#) do not set [VR::SQ](#) on bytevalue data element

**Examples**

[DuplicatePCDE.cxx](#), and [GenFakeIdentifyFile.cxx](#).

Referenced by [gdcM::Attribute< Group, Element, TVR, TVM >::GetAsDataElement\(\)](#), [gdcM::Attribute< Group, Element, TVR, VM::VM1 >::GetAsDataElement\(\)](#), [gdcM::Attribute< Group, Element, TVR, VM::VM1\\_n >::GetAsDataElement\(\)](#), [gdcM::Element< TVR, TVM >::GetAsDataElement\(\)](#), [gdcM::Element< TVR, VM::VM1\\_n >::GetAsDataElement\(\)](#), [gdcM::Attribute< Group, Element, TVR, TVM >::SetFromDataElement\(\)](#), [gdcM::Attribute< Group, Element, TVR, VM::VM1 >::SetFromDataElement\(\)](#), [gdcM::Attribute< Group, Element, TVR, VM::VM1\\_n >::SetFromDataElement\(\)](#), [gdcM::Element< TVR, TVM >::SetFromDataElement\(\)](#), and [gdcM::Element< TVR, VM::VM1\\_n >::SetFromDataElement\(\)](#).

**10.72.4.15 IsEmpty()**

```
bool gdcM::DataElement::IsEmpty ( ) const [inline]
```

Check if Data [Element](#) is empty.

**Examples**

[DumpADAC.cxx](#), [DumpExamCard.cxx](#), [DumpImageHeaderInfo.cxx](#), [DumpToshibaDTI.cxx](#), [DumpToshibaDTI2.cxx](#), [ELSCINT1WaveToText.cxx](#), [FixJAIBugJPEGLS.cxx](#), [pmsct\\_rgb1.cxx](#), and [rle2img.cxx](#).

Referenced by [gdcM::DataSet::InsertDataElement\(\)](#), [gdcM::Attribute< Group, Element, TVR, TVM >::SetFromDataElement\(\)](#), [gdcM::Attribute< Group, Element, TVR, VM::VM1 >::SetFromDataElement\(\)](#), and [gdcM::Attribute< Group, Element, TVR, VM::VM1\\_n >::SetFromDataElement\(\)](#).



#### 10.72.4.16 IsUndefinedLength()

```
bool gdcm::DataElement::IsUndefinedLength ( ) const [inline]
```

return if [Value](#) Length if of undefined length

#### 10.72.4.17 operator<()

```
bool gdcm::DataElement::operator< (
    const DataElement & de ) const [inline]
```

References [GetTag\(\)](#).

#### 10.72.4.18 operator=()

```
DataElement& gdcm::DataElement::operator= (
    const DataElement & ) [default]
```

#### 10.72.4.19 operator==( )

```
bool gdcm::DataElement::operator==(
    const DataElement & de ) const [inline]
```

References [TagField](#), [ValueField](#), [ValueLengthField](#), and [VRField](#).

#### 10.72.4.20 Read()

```
template<typename TDE , typename TSwap >
std::istream& gdcm::DataElement::Read (
    std::istream & is ) [inline]
```

#### Examples

[DumpSiemensBase64.cxx](#).

#### 10.72.4.21 ReadOrSkip()

```
template<typename TDE , typename TSwap >
std::istream& gdcM::DataElement::ReadOrSkip (
    std::istream & is,
    std::set< Tag > const & skiptags ) [inline]
```

#### 10.72.4.22 ReadPreValue()

```
template<typename TDE , typename TSwap >
std::istream& gdcM::DataElement::ReadPreValue (
    std::istream & is,
    std::set< Tag > const & skiptags ) [inline]
```

#### 10.72.4.23 ReadValue()

```
template<typename TDE , typename TSwap >
std::istream& gdcM::DataElement::ReadValue (
    std::istream & is,
    std::set< Tag > const & skiptags ) [inline]
```

#### 10.72.4.24 ReadValueWithLength()

```
template<typename TDE , typename TSwap >
std::istream& gdcM::DataElement::ReadValueWithLength (
    std::istream & is,
    VL & length,
    std::set< Tag > const & skiptags ) [inline]
```

#### 10.72.4.25 ReadWithLength()

```
template<typename TDE , typename TSwap >
std::istream& gdcM::DataElement::ReadWithLength (
    std::istream & is,
    VL & length ) [inline]
```

#### 10.72.4.26 SetByteValue()

```
void gdcm::DataElement::SetByteValue (
    const char * array,
    VL length ) [inline]
```

Set the byte value

##### Warning

user need to read DICOM standard for an understanding of:

- even padding
- \0 vs space padding By default even padding is achieved using \0 regardless of the of [VR](#)

##### Examples

[ChangePrivateTags.cxx](#), [ChangeSequenceUltrasound.cxx](#), [CreateARGBImage.cxx](#), [CreateCMYKImage.cxx](#), [Fake\\_Image\\_Using\\_Stream\\_Image\\_Writer.cxx](#), [FileChangeTS.cs](#), [FileChangeTSLossy.cs](#), [FixBrokenJ2K.cxx](#), [FixJAIBugJPEGLS.cxx](#), [GenFakelIdentifyFile.cxx](#), [GenFakeImage.cxx](#), [GenLongSeqs.cxx](#), [GenSeqs.cxx](#), [GetSubSequenceData.cxx](#), [NewSequence.cs](#), [StreamImageReaderTest.cxx](#), [iU22tomultisc.cxx](#), and [rle2img.cxx](#).

Referenced by `gdcm::Attribute< Group, Element, TVR, TVM >::GetAsDataElement()`, `gdcm::Attribute< Group, Element, TVR, VM::VM1 >::GetAsDataElement()`, `gdcm::Attribute< Group, Element, TVR, VM::VM1_n >::GetAsDataElement()`, `gdcm::Element< TVR, TVM >::GetAsDataElement()`, and `gdcm::Element< TVR, VM::VM1_n >::GetAsDataElement()`.

#### 10.72.4.27 SetTag()

```
void gdcm::DataElement::SetTag (
    const Tag & t ) [inline]
```

Set [Tag](#) Use with cautious (need to match Part 6)

##### Examples

[Extracting\\_All\\_Resolution.cxx](#), [Fake\\_Image\\_Using\\_Stream\\_Image\\_Writer.cxx](#), [GenFakelIdentifyFile.cxx](#), and [GetSubSequenceData.cxx](#).

#### 10.72.4.28 SetValue()

```
void gdcM::DataElement::SetValue (
    Value const & vl ) [inline]
```

##### Warning

you need to set the ValueLengthField explicitly

##### Examples

[DuplicatePCDE.cxx](#), [Fake\\_Image\\_Using\\_Stream\\_Image\\_Writer.cxx](#), [FixBrokenJ2K.cxx](#), [GenFakeIdentifyFile.cxx](#), [GenLongSeqs.cxx](#), and [GenSeqs.cxx](#).

References [gdcM::Value::GetLength\(\)](#).

#### 10.72.4.29 SetValueFieldLength()

```
void gdcM::DataElement::SetValueFieldLength (
    VL vl,
    bool readvalues ) [protected]
```

#### 10.72.4.30 SetVL()

```
void gdcM::DataElement::SetVL (
    const VL & vl ) [inline]
```

Set [VL](#) Use with cautious (need to match Part 6), advanced user only

##### See also

[SetByteValue](#)

#### 10.72.4.31 SetVLToUndefined()

```
void gdcM::DataElement::SetVLToUndefined ( )
```

##### Examples

[Fake\\_Image\\_Using\\_Stream\\_Image\\_Writer.cxx](#), [GenAllVR.cxx](#), [GenFakeIdentifyFile.cxx](#), [GenLongSeqs.cxx](#), [GenSeqs.cxx](#), and [NewSequence.cs](#).

### 10.72.4.32 SetVR()

```
void gdcm::DataElement::SetVR (
    VR const & vr ) [inline]
```

Set [VR](#) Use with cautious (need to match Part 6), advanced user only

#### Precondition

vr is a [VR::VRALL](#) (not a dual one such as OB\_OW)

#### Examples

[Fake\\_Image\\_Using\\_Stream\\_Image\\_Writer.cxx](#), [FixBrokenJ2K.cxx](#), [FixJAIBugJPEGLS.cxx](#), [GenFakeIdentifyFile.cxx](#), [GenLongSeqs.cxx](#), [GenSeqs.cxx](#), [GetSubSequenceData.cxx](#), [NewSequence.cs](#), [StreamImageReaderTest.cxx](#), [iU22tomultisc.cxx](#), and [rle2img.cxx](#).

References [gdcm::VR::IsVRFile\(\)](#).

Referenced by [gdcm::Attribute< Group, Element, TVR, TVM >::GetAsDataElement\(\)](#), [gdcm::Attribute< Group, Element, TVR, VM::VM1 >::GetAsDataElement\(\)](#), [gdcm::Attribute< Group, Element, TVR, VM::VM1\\_n >::GetAsDataElement\(\)](#), [gdcm::Element< TVR, TVM >::GetAsDataElement\(\)](#), and [gdcm::Element< TVR, VM::VM1\\_n >::GetAsDataElement\(\)](#).

### 10.72.4.33 Write()

```
template<typename TDE , typename TSwap >
const std::ostream& gdcm::DataElement::Write (
    std::ostream & os ) const [inline]
```

## 10.72.5 Friends And Related Function Documentation

### 10.72.5.1 operator<<

```
std::ostream& operator<< (
    std::ostream & _os,
    const DataElement & _val ) [friend]
```

### 10.72.6 Member Data Documentation

### 10.72.6.1 TagField

`Tag` `gdcm::DataElement::TagField` [protected]

Referenced by `operator==()`.

### 10.72.6.2 ValueField

`ValuePtr` `gdcm::DataElement::ValueField` [protected]

Referenced by `operator==()`.

### 10.72.6.3 ValueLengthField

`VL` `gdcm::DataElement::ValueLengthField` [protected]

Referenced by `operator==()`.

### 10.72.6.4 VRField

`VR` `gdcm::DataElement::VRField` [protected]

Referenced by `operator==()`.

The documentation for this class was generated from the following file:

- [gdcmDataElement.h](#)

## 10.73 gdcm::DataElementException Class Reference

```
#include <gdcmDataSet.h>
```

Inheritance diagram for gdcm::DataElementException:

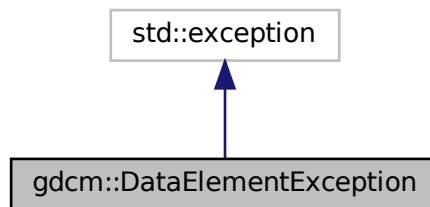

Collaboration diagram for gdcm::DataElementException:

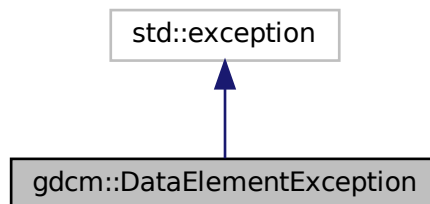

The documentation for this class was generated from the following file:

- [gdcmDataSet.h](#)

## 10.74 gdcm::DataEvent Class Reference

[DataEvent](#).

```
#include <gdcmDataEvent.h>
```

Inheritance diagram for `gdcM::DataEvent`:

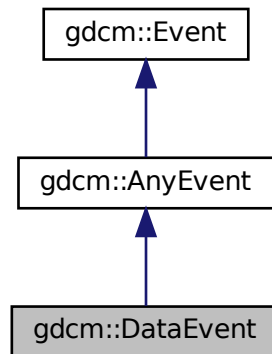

Collaboration diagram for `gdcM::DataEvent`:

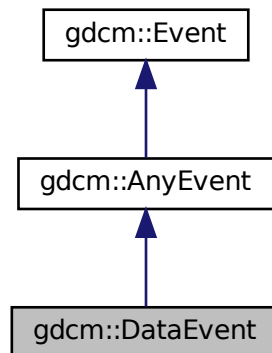

## Public Types

- typedef [DataEvent](#) Self
- typedef [AnyEvent](#) Superclass



## Public Member Functions

- [DataEvent](#) (const char \*bytes=nullptr, size\_t len=0)
- [DataEvent](#) (const [Self](#) &s)
- [~DataEvent](#) () override=default
- bool [CheckEvent](#) (const ::gdcm::Event \*e) const override
- const char \* [GetData](#) () const
- size\_t [GetDataLength](#) () const
- const char \* [GetEventName](#) () const override
- ::gdcm::Event \* [MakeObject](#) () const override
- void [operator=](#) (const [Self](#) &)=delete
- void [SetData](#) (const char \*bytes, size\_t len)

### 10.74.1 Detailed Description

[DataEvent](#).

### 10.74.2 Member Typedef Documentation

#### 10.74.2.1 Self

```
typedef DataEvent gdcm::DataEvent::Self
```

#### 10.74.2.2 Superclass

```
typedef AnyEvent gdcm::DataEvent::Superclass
```

### 10.74.3 Constructor & Destructor Documentation

#### 10.74.3.1 DataEvent() [1/2]

```
gdcm::DataEvent::DataEvent (  
    const char * bytes = nullptr,  
    size_t len = 0 ) [inline]
```

### 10.74.3.2 ~DataEvent()

```
gdcM::DataEvent::~~DataEvent ( ) [override], [default]
```

### 10.74.3.3 DataEvent() [2/2]

```
gdcM::DataEvent::DataEvent (
    const Self & s ) [inline]
```

## 10.74.4 Member Function Documentation

### 10.74.4.1 CheckEvent()

```
bool gdcM::DataEvent::CheckEvent (
    const ::gdcM::Event * e ) const [inline], [override]
```

### 10.74.4.2 GetData()

```
const char* gdcM::DataEvent::GetData ( ) const [inline]
```

### 10.74.4.3 GetDataLength()

```
size_t gdcM::DataEvent::GetDataLength ( ) const [inline]
```

### 10.74.4.4 GetEventName()

```
const char* gdcM::DataEvent::GetEventName ( ) const [inline], [override], [virtual]
```

Return the StringName associated with the event.

Implements [gdcM::Event](#).

#### 10.74.4.5 MakeObject()

```
::gdcm::Event* gdcm::DataEvent::MakeObject ( ) const [inline], [override], [virtual]
```

Create an [Event](#) of this type This method work as a Factory for creating events of each particular type.

Implements [gdcm::Event](#).

#### 10.74.4.6 operator=()

```
void gdcm::DataEvent::operator= (
    const Self & ) [delete]
```

#### 10.74.4.7 SetData()

```
void gdcm::DataEvent::SetData (
    const char * bytes,
    size_t len ) [inline]
```

The documentation for this class was generated from the following file:

- [gdcmDataEvent.h](#)

## 10.75 gdcm::DataSet Class Reference

Class to represent a Data Set (which contains Data Elements)

```
#include <gdcmDataSet.h>
```

Inheritance diagram for gdcm::DataSet:

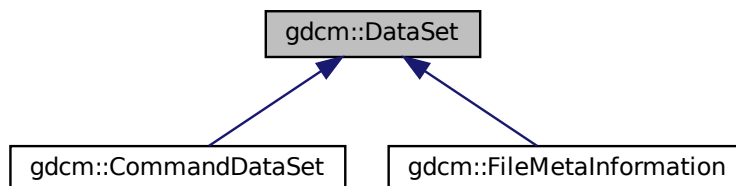

## Public Types

- typedef DataElementSet::const\_iterator [ConstIterator](#)
- typedef std::set< [DataElement](#) > [DataElementSet](#)
- typedef DataElementSet::iterator [Iterator](#)
- typedef DataElementSet::size\_type [SizeType](#)

## Public Member Functions

- [Iterator](#) [Begin](#) ()
- [ConstIterator](#) [Begin](#) () const
- void [Clear](#) ()
- template<typename TDE >  
unsigned int [ComputeGroupLength](#) ([Tag](#) const &tag) const
- [Iterator](#) [End](#) ()
- [ConstIterator](#) [End](#) () const
- bool [FindDataElement](#) (const [PrivateTag](#) &t) const  
*Look up if private tag 't' is present in the dataset:*
- bool [FindDataElement](#) (const [Tag](#) &t) const
- const [DataElement](#) & [FindNextDataElement](#) (const [Tag](#) &t) const
- const [DataElement](#) & [GetDataElement](#) (const [PrivateTag](#) &t) const  
*Return the dataelement.*
- const [DataElement](#) & [GetDataElement](#) (const [Tag](#) &t) const
- [DataElementSet](#) & [GetDES](#) ()
- const [DataElementSet](#) & [GetDES](#) () const
- template<typename TDE >  
[VL](#) [GetLength](#) () const
- [MediaStorage](#) [GetMediaStorage](#) () const
- std::string [GetPrivateCreator](#) (const [Tag](#) &t) const  
*Return the private creator of the private tag 't':*
- void [Insert](#) (const [DataElement](#) &de)
- bool [IsEmpty](#) () const  
*Returns if the dataset is empty.*
- const [DataElement](#) & [operator](#)() (uint16\_t group, uint16\_t element) const
- [DataSet](#) & [operator=](#) ([DataSet](#) const &)=default
- const [DataElement](#) & [operator](#)[] (const [Tag](#) &t) const
- void [Print](#) (std::ostream &os, std::string const &indent="") const
- template<typename TDE , typename TSwap >  
std::istream & [Read](#) (std::istream &is)
- template<typename TDE , typename TSwap >  
std::istream & [ReadNested](#) (std::istream &is)
- template<typename TDE , typename TSwap >  
std::istream & [ReadSelectedPrivateTags](#) (std::istream &is, const std::set< [PrivateTag](#) > &tags, bool readvalues=true)
- template<typename TDE , typename TSwap >  
std::istream & [ReadSelectedPrivateTagsWithLength](#) (std::istream &is, const std::set< [PrivateTag](#) > &tags, [VL](#) &length, bool readvalues=true)
- template<typename TDE , typename TSwap >  
std::istream & [ReadSelectedTags](#) (std::istream &is, const std::set< [Tag](#) > &tags, bool readvalues=true)

- `template<typename TDE , typename TSwap >`  
`std::istream & ReadSelectedTagsWithLength (std::istream &is, const std::set< Tag > &tags, VL &length, bool readvalues=true)`
- `template<typename TDE , typename TSwap >`  
`std::istream & ReadUpToTag (std::istream &is, const Tag &t, std::set< Tag > const &skiptags)`
- `template<typename TDE , typename TSwap >`  
`std::istream & ReadUpToTagWithLength (std::istream &is, const Tag &t, std::set< Tag > const &skiptags, VL &length)`
- `template<typename TDE , typename TSwap >`  
`std::istream & ReadWithLength (std::istream &is, VL &length)`
- `SizeType Remove (const Tag &tag)`  
*Completely remove a dataelement from the dataset.*
- `void Replace (const DataElement &de)`  
*Replace a dataelement with another one.*
- `void ReplaceEmpty (const DataElement &de)`  
*Only replace a DICOM attribute when it is missing or empty.*
- `SizeType Size () const`
- `template<typename TDE , typename TSwap >`  
`std::ostream const & Write (std::ostream &os) const`

## Protected Member Functions

- `Tag ComputeDataElement (const PrivateTag &t) const`
- `const DataElement & GetDEEnd () const`
- `void InsertDataElement (const DataElement &de)`

## Friends

- class `CSAHeader`
- `std::ostream & operator<< (std::ostream &_os, const DataSet &)`

### 10.75.1 Detailed Description

Class to represent a Data Set (which contains Data Elements)

A Data Set represents an instance of a real world Information [Object](#)

#### Note

DATA SET: Exchanged information consisting of a structured set of [Attribute](#) values directly or indirectly related to Information Objects. The value of each [Attribute](#) in a Data Set is expressed as a Data [Element](#). A collection of Data Elements ordered by increasing Data [Element Tag](#) number that is an encoding of the values of Attributes of a real world object.

Implementation note. If one do: `DataSet ds; ds.SetLength(0); ds.Read(is);` setting length to 0 actually means try to read is as if it was a root [DataSet](#). Other value are undefined (nested dataset with undefined length) or defined length (different from 0) means nested dataset with defined length.

## Warning

a [DataSet](#) does not have a Transfer Syntax type, only a [File](#) does.

## Examples

[ChangePrivateTags.cxx](#), [ChangeSequenceUltrasound.cxx](#), [CreateFakeRTDOSE.cxx](#), [CreateJPIPDataSet.cxx](#), [DeriveSeries.cxx](#), [DiffFile.cxx](#), [DumpADAC.cxx](#), [DumpExamCard.cxx](#), [DumpGEMSMovieGroup.cxx](#), [DumpImageHeaderInfo.cxx](#), [DumpPhilipsECHO.cxx](#), [DumpSiemensBase64.cxx](#), [DumpToshibaDTI.cxx](#), [DumpToshibaDTI2.cxx](#), [DumpVisusChange.cxx](#), [DuplicatePCDE.cxx](#), [ELSCINT1WaveToText.cxx](#), [ExtractEncryptedContent.cxx](#), [Extracting\\_All\\_Resolution.cxx](#), [Fake\\_Image\\_Using\\_Stream\\_Image\\_Writer.cxx](#), [FixOrientation.cxx](#), [GenAllVR.cxx](#), [GenFakeIdentifyFile.cxx](#), [GenLongSeqs.cxx](#), [GenSeqs.cxx](#), [GetJPEGSamplePrecision.cxx](#), [GetSequenceUltrasound.cxx](#), [GetSubSequenceData.cxx](#), [HelloWorld.cxx](#), [LargeVRDSExplicit.cxx](#), [MergeTwoFiles.cxx](#), [MrProtocol.cxx](#), [PatchFile.cxx](#), [ReadAndDumpDICOMDIR.cxx](#), [ReadAndPrintAttributes.cxx](#), [SortImage.cxx](#), [StreamImageReaderTest.cxx](#), [TemplateEmptyImage.cxx](#), [VolumeSorter.cxx](#), [csa2img.cxx](#), [gdcmrtonplan.cxx](#), [gdcmrtpplan.cxx](#), [iU22tomultisc.cxx](#), [pmsct\\_rgb1.cxx](#), and [rle2img.cxx](#).

## 10.75.2 Member Typedef Documentation

### 10.75.2.1 ConstIterator

```
typedef DataSet::const_iterator gdcm::DataSet::ConstIterator
```

## Examples

[DumpVisusChange.cxx](#).

### 10.75.2.2 DataSet

```
typedef std::set<DataElement> gdcm::DataSet::DataSet
```

### 10.75.2.3 Iterator

```
typedef DataSet::iterator gdcm::DataSet::Iterator
```

### 10.75.2.4 SizeType

```
typedef DataSet::size_type gdcm::DataSet::SizeType
```

## 10.75.3 Member Function Documentation

### 10.75.3.1 Begin() [1/2]

`Iterator` gdcm::DataSet::Begin ( ) [inline]

### 10.75.3.2 Begin() [2/2]

`ConstIterator` gdcm::DataSet::Begin ( ) const [inline]

#### Examples

[DiffFile.cxx](#), and [DuplicatePCDE.cxx](#).

### 10.75.3.3 Clear()

`void` gdcm::DataSet::Clear ( ) [inline]

Referenced by `gdcm::Item::Read()`.

### 10.75.3.4 ComputeDataElement()

`Tag` gdcm::DataSet::ComputeDataElement (   
const `PrivateTag` & `t` ) const [protected]

### 10.75.3.5 ComputeGroupLength()

```
template<typename TDE >  
unsigned int gdcm::DataSet::ComputeGroupLength (   
    Tag const & tag ) const [inline]
```

References `gdcm::Tag::GetElement()`, and `gdcm::Tag::GetGroup()`.

**10.75.3.6 End()** [1/2]

```
Iterator gdcM::DataSet::End ( ) [inline]
```

**10.75.3.7 End()** [2/2]

```
ConstIterator gdcM::DataSet::End ( ) const [inline]
```

**Examples**

[DiffFile.cxx](#), and [DuplicatePCDE.cxx](#).

**10.75.3.8 FindDataElement()** [1/2]

```
bool gdcM::DataSet::FindDataElement (
    const PrivateTag & t ) const
```

Look up if private tag 't' is present in the dataset:

**Examples**

[ChangePrivateTags.cxx](#), [ChangeSequenceUltrasound.cxx](#), [DumpADAC.cxx](#), [DumpExamCard.cxx](#), [DumpGEMSMovieGroup.cxx](#), [DumpImageHeaderInfo.cxx](#), [DumpPhilipsECHO.cxx](#), [DumpSiemensBase64.cxx](#), [DumpToshibaDTI.cxx](#), [DumpToshibaDTI2.cxx](#), [DumpVisusChange.cxx](#), [ELSCINT1WaveToText.cxx](#), [ExtractEncryptedContent.cxx](#), [GetSequenceUltrasound.cxx](#), [GetSubSequenceData.cxx](#), [LargeVRDSExplicit.cxx](#), [MrProtocol.cxx](#), [ReadAndDumpDICOMDIR.cxx](#), [ReadAndPrintAttributes.cxx](#), [csa2img.cxx](#), [gdcMrtionplan.cxx](#), [gdcMrtplan.cxx](#), [pmsct\\_rgb1.cxx](#), and [rle2img.cxx](#).

Referenced by `gdcM::Attribute< Group, Element, TVR, TVM >::SetFromDataSet()`, `gdcM::Attribute< Group, Element, TVR, VM::VM1 >::SetFromDataSet()`, and `gdcM::Attribute< Group, Element, TVR, VM::VM1_n >::SetFromDataSet()`.

**10.75.3.9 FindDataElement()** [2/2]

```
bool gdcM::DataSet::FindDataElement (
    const Tag & t ) const [inline]
```



### 10.75.3.10 FindNextDataElement()

```
const DataElement& gdcm::DataSet::FindNextDataElement (
    const Tag & t ) const [inline]
```

#### Examples

[DuplicatePCDE.cxx](#).

### 10.75.3.11 GetDataElement() [1/2]

```
const DataElement& gdcm::DataSet::GetDataElement (
    const PrivateTag & t ) const
```

Return the dataelement.

### 10.75.3.12 GetDataElement() [2/2]

```
const DataElement& gdcm::DataSet::GetDataElement (
    const Tag & t ) const [inline]
```

Return the [DataElement](#) with [Tag](#) 't'

#### Warning

: This only search at the 'root level' of the [DataSet](#)

#### Examples

[ChangePrivateTags.cxx](#), [ChangeSequenceUltrasound.cxx](#), [DeriveSeries.cxx](#), [DumpADAC.cxx](#), [DumpExamCard.cxx](#), [DumpGEMSMovieGroup.cxx](#), [DumpImageHeaderInfo.cxx](#), [DumpPhilipsECHO.cxx](#), [DumpSiemensBase64.cxx](#), [DumpToshibaDTI.cxx](#), [DumpToshibaDTI2.cxx](#), [DumpVisusChange.cxx](#), [ELSCINT1WaveToText.cxx](#), [ExtractEncryptedContent.cxx](#), [FixBrokenJ2K.cxx](#), [FixJAIBugJPEGLS.cxx](#), [GetJPEGSamplePrecision.cxx](#), [GetSequenceUltrasound.cxx](#), [GetSubSequenceData.cxx](#), [LargeVRDSExplicit.cxx](#), [MrProtocol.cxx](#), [PatchFile.cxx](#), [ReadAndDumpDICOMDIR.cxx](#), [ReadExplicitLengthSQIVR.cxx](#), [csa2img.cxx](#), [gdcmrtionplan.cxx](#), [gdcmrtplan.cxx](#), [iU22tomultisc.cxx](#), [pmsct\\_rgb1.cxx](#), and [rle2img.cxx](#).

Referenced by [gdcm::Attribute< Group, Element, TVR, TVM >::Set\(\)](#), [gdcm::Attribute< Group, Element, TVR, VM::VM1 >::Set\(\)](#), [gdcm::Attribute< Group, Element, TVR, VM::VM1\\_n >::Set\(\)](#), [gdcm::Attribute< Group, Element, TVR, TVM >::SetFromDataSet\(\)](#), [gdcm::Attribute< Group, Element, TVR, VM::VM1 >::SetFromDataSet\(\)](#), and [gdcm::Attribute< Group, Element, TVR, VM::VM1\\_n >::SetFromDataSet\(\)](#).

### 10.75.3.13 GetDEEnd()

```
const DataElement& gdcM::DataSet::GetDEEnd ( ) const [protected]
```

### 10.75.3.14 GetDES() [1/2]

```
DataElementSet& gdcM::DataSet::GetDES ( ) [inline]
```

### 10.75.3.15 GetDES() [2/2]

```
const DataElementSet& gdcM::DataSet::GetDES ( ) const [inline]
```

#### Examples

[ReadAndDumpDICOMDIR.cxx](#).

### 10.75.3.16 GetLength()

```
template<typename TDE >  
VL gdcM::DataSet::GetLength ( ) const [inline]
```

References [gdcM::VL::GetLength\(\)](#).

### 10.75.3.17 GetMediaStorage()

```
MediaStorage gdcM::DataSet::GetMediaStorage ( ) const
```

### 10.75.3.18 GetPrivateCreator()

```
std::string gdcM::DataSet::GetPrivateCreator (   
    const Tag & t ) const
```

Return the private creator of the private tag 't':

#### Examples

[DuplicatePCDE.cxx](#).

### 10.75.3.19 Insert()

```
void gdcM::DataSet::Insert (
    const DataElement & de ) [inline]
```

Insert a [DataElement](#) in the [DataSet](#).

#### Warning

: [Tag](#) need to be  $\geq 0x8$  to be considered valid data element

#### Examples

[CreateJPIPDataSet.cxx](#), [DumpSiemensBase64.cxx](#), [DuplicatePCDE.cxx](#), [Extracting\\_All\\_Resolution.cxx](#), [Fake\\_Image\\_Using\\_Stream\\_Image\\_Writer.cxx](#), [GenAllVR.cxx](#), [GenFakeIdentifyFile.cxx](#), [GenLongSeqs.cxx](#), [GenSeqs.cxx](#), [NewSequence.cs](#), [StreamImageReaderTest.cxx](#), and [TemplateEmptyImage.cxx](#).

References [gdcMErrorMacro](#), [gdcM::Tag::GetGroup\(\)](#), and [gdcM::DataElement::GetTag\(\)](#).

### 10.75.3.20 InsertDataElement()

```
void gdcM::DataSet::InsertDataElement (
    const DataElement & de ) [inline], [protected]
```

References [gdcMWarningMacro](#), [gdcM::Value::GetLength\(\)](#), [gdcM::DataElement::GetValue\(\)](#), [gdcM::DataElement::↔GetVL\(\)](#), and [gdcM::DataElement::IsEmpty\(\)](#).

### 10.75.3.21 IsEmpty()

```
bool gdcM::DataSet::IsEmpty ( ) const [inline]
```

Returns if the dataset is empty.

Referenced by [gdcM::Item::Read\(\)](#).

### 10.75.3.22 operator()

```
const DataElement& gdcM::DataSet::operator() (
    uint16_t group,
    uint16_t element ) const [inline]
```

### 10.75.3.23 operator=()

```
DataSet& gdcM::DataSet::operator= (
    DataSet const & ) [default]
```

### 10.75.3.24 operator[]()

```
const DataElement& gdcM::DataSet::operator[] (
    const Tag & t ) const [inline]
```

### 10.75.3.25 Print()

```
void gdcM::DataSet::Print (
    std::ostream & os,
    std::string const & indent = "" ) const [inline]
```

### 10.75.3.26 Read()

```
template<typename TDE , typename TSwap >
std::istream& gdcM::DataSet::Read (
    std::istream & is )
```

#### Examples

[DumpToshibaDTI.cxx](#), and [DumpToshibaDTI2.cxx](#).

### 10.75.3.27 ReadNested()

```
template<typename TDE , typename TSwap >
std::istream& gdcM::DataSet::ReadNested (
    std::istream & is )
```

### 10.75.3.28 ReadSelectedPrivateTags()

```
template<typename TDE , typename TSwap >
std::istream& gdcm::DataSet::ReadSelectedPrivateTags (
    std::istream & is,
    const std::set< PrivateTag > & tags,
    bool readvalues = true )
```

### 10.75.3.29 ReadSelectedPrivateTagsWithLength()

```
template<typename TDE , typename TSwap >
std::istream& gdcm::DataSet::ReadSelectedPrivateTagsWithLength (
    std::istream & is,
    const std::set< PrivateTag > & tags,
    VL & length,
    bool readvalues = true )
```

### 10.75.3.30 ReadSelectedTags()

```
template<typename TDE , typename TSwap >
std::istream& gdcm::DataSet::ReadSelectedTags (
    std::istream & is,
    const std::set< Tag > & tags,
    bool readvalues = true )
```

### 10.75.3.31 ReadSelectedTagsWithLength()

```
template<typename TDE , typename TSwap >
std::istream& gdcm::DataSet::ReadSelectedTagsWithLength (
    std::istream & is,
    const std::set< Tag > & tags,
    VL & length,
    bool readvalues = true )
```

### 10.75.3.32 ReadUpToTag()

```
template<typename TDE , typename TSwap >
std::istream& gdcm::DataSet::ReadUpToTag (
    std::istream & is,
    const Tag & t,
    std::set< Tag > const & skiptags )
```

### 10.75.3.33 ReadUpToTagWithLength()

```
template<typename TDE , typename TSwap >
std::istream& gdcM::DataSet::ReadUpToTagWithLength (
    std::istream & is,
    const Tag & t,
    std::set< Tag > const & skiptags,
    VL & length )
```

### 10.75.3.34 ReadWithLength()

```
template<typename TDE , typename TSwap >
std::istream& gdcM::DataSet::ReadWithLength (
    std::istream & is,
    VL & length )
```

### 10.75.3.35 Remove()

```
SizeType gdcM::DataSet::Remove (
    const Tag & tag ) [inline]
```

Completely remove a dataelement from the dataset.

#### Examples

[ClinicalTrialIdentificationWorkflow.cs](#), [GenFakelIdentifyFile.cxx](#), [LargeVRDSExplicit.cxx](#), [MergeTwoFiles.cxx](#), [ReformatFile.cs](#), [StandardizeFiles.cs](#), [pmsct\\_rgb1.cxx](#), and [rle2img.cxx](#).

### 10.75.3.36 Replace()

```
void gdcM::DataSet::Replace (
    const DataElement & de ) [inline]
```

Replace a dataelement with another one.

#### Examples

[ChangePrivateTags.cxx](#), [ChangeSequenceUltrasound.cxx](#), [CreateFakeRTDOSE.cxx](#), [DeriveSeries.cxx](#), [FixBrokenJ2K.cxx](#), [FixJAIBugJPEGLS.cxx](#), [FixOrientation.cxx](#), [GenFakelIdentifyFile.cxx](#), [HelloWorld.cxx](#), [LargeVRDSExplicit.cxx](#), [PatchFile.cxx](#), [iU22tomultisc.cxx](#), [pmsct\\_rgb1.cxx](#), and [rle2img.cxx](#).

References [gdcMAssertAlwaysMacro](#).

### 10.75.3.37 ReplaceEmpty()

```
void gdcm::DataSet::ReplaceEmpty (
    const DataElement & de ) [inline]
```

Only replace a DICOM attribute when it is missing or empty.

#### Examples

[rle2img.cxx](#).

References [gdcmAssertAlwaysMacro](#).

### 10.75.3.38 Size()

```
SizeType gdcm::DataSet::Size ( ) const [inline]
```

#### Examples

[DumpGEMSMovieGroup.cxx](#).

Referenced by [gdcm::SequenceOfItems::Read\(\)](#).

### 10.75.3.39 Write()

```
template<typename TDE , typename TSwap >
std::ostream const& gdcm::DataSet::Write (
    std::ostream & os ) const
```

## 10.75.4 Friends And Related Function Documentation

### 10.75.4.1 CSAHeader

```
friend class CSAHeader [friend]
```

### 10.75.4.2 operator<<

```
std::ostream& operator<< (
    std::ostream & _os,
    const DataSet & val ) [friend]
```

The documentation for this class was generated from the following file:

- [gdcmDataSet.h](#)

## 10.76 gdcm::DataSetEvent Class Reference

[DataSetEvent](#).

```
#include <gdcmDataSetEvent.h>
```

Inheritance diagram for gdcm::DataSetEvent:

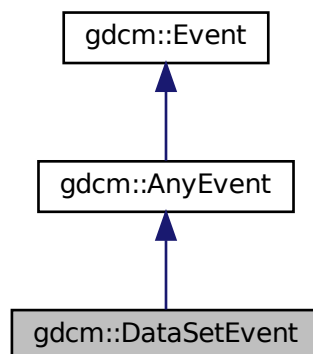



Collaboration diagram for gdcm::DataSetEvent:

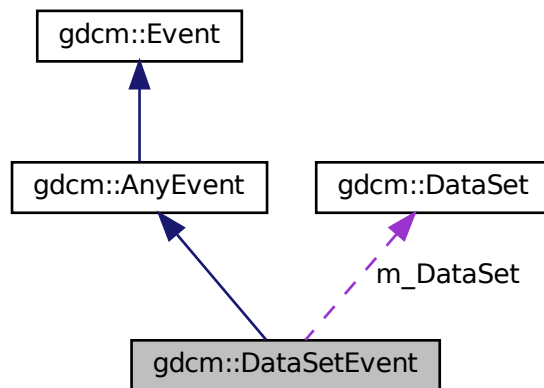

## Public Types

- typedef [DataSetEvent Self](#)
- typedef [AnyEvent Superclass](#)

## Public Member Functions

- [DataSetEvent](#) (const [Self](#) &s)
- [DataSetEvent](#) ([DataSet](#) const \*ds=nullptr)
- [~DataSetEvent](#) () override=default
- bool [CheckEvent](#) (const ::gdcm::Event \*e) const override
- [DataSet](#) const & [GetDataSet](#) () const
- const char \* [GetEventName](#) () const override
- ::gdcm::Event \* [MakeObject](#) () const override
- void [operator=](#) (const [Self](#) &)=delete

## Public Attributes

- const [DataSet](#) \* [m\\_DataSet](#)

### 10.76.1 Detailed Description

[DataSetEvent](#).

Special type of event triggered during the [DataSet](#) store/move process

See also

## 10.76.2 Member Typedef Documentation

### 10.76.2.1 Self

```
typedef DataSetEvent gdcM::DataSetEvent::Self
```

### 10.76.2.2 Superclass

```
typedef AnyEvent gdcM::DataSetEvent::Superclass
```

## 10.76.3 Constructor & Destructor Documentation

### 10.76.3.1 DataSetEvent() [1/2]

```
gdcM::DataSetEvent::DataSetEvent (  
    DataSet const * ds = nullptr ) [inline]
```

### 10.76.3.2 ~DataSetEvent()

```
gdcM::DataSetEvent::~~DataSetEvent ( ) [override], [default]
```

### 10.76.3.3 DataSetEvent() [2/2]

```
gdcM::DataSetEvent::DataSetEvent (  
    const Self & s ) [inline]
```

## 10.76.4 Member Function Documentation

#### 10.76.4.1 CheckEvent()

```
bool gdcM::DataSetEvent::CheckEvent (
    const ::gdcM::Event * e ) const [inline], [override]
```

#### 10.76.4.2 GetDataSet()

```
DataSet const& gdcM::DataSetEvent::GetDataSet ( ) const [inline]
```

References `m_DataSet`.

#### 10.76.4.3 GetEventName()

```
const char* gdcM::DataSetEvent::GetEventName ( ) const [inline], [override], [virtual]
```

Return the `StringName` associated with the event.

Implements `gdcM::Event`.

#### 10.76.4.4 MakeObject()

```
::gdcM::Event* gdcM::DataSetEvent::MakeObject ( ) const [inline], [override], [virtual]
```

Create an `Event` of this type This method work as a Factory for creating events of each particular type.

Implements `gdcM::Event`.

#### 10.76.4.5 operator=()

```
void gdcM::DataSetEvent::operator= (
    const Self & ) [delete]
```

### 10.76.5 Member Data Documentation

### 10.76.5.1 m\_DataSet

```
const DataSet* gdcM::DataSetEvent::m_DataSet
```

Referenced by GetDataSet().

The documentation for this class was generated from the following file:

- [gdcMDataSetEvent.h](#)

## 10.77 gdcM::DataSetHelper Class Reference

[DataSetHelper](#) (internal class, not intended for user level)

```
#include <gdcMDataSetHelper.h>
```

### Static Public Member Functions

- static [VR ComputeVR](#) ([File](#) const &file, [DataSet](#) const &ds, const [Tag](#) &tag)

### 10.77.1 Detailed Description

[DataSetHelper](#) (internal class, not intended for user level)

### 10.77.2 Member Function Documentation

#### 10.77.2.1 ComputeVR()

```
static VR gdcM::DataSetHelper::ComputeVR (  
    File const & file,  
    DataSet const & ds,  
    const Tag & tag ) [static]
```

ds -> current dataset, which is not the same as the root dataset return [VR::INVALID](#) in case of error

The documentation for this class was generated from the following file:

- [gdcMDataSetHelper.h](#)

## 10.78 gdcm::Decoder Class Reference

[Decoder.](#)

```
#include <gdcmDecoder.h>
```

Inheritance diagram for gdcm::Decoder:

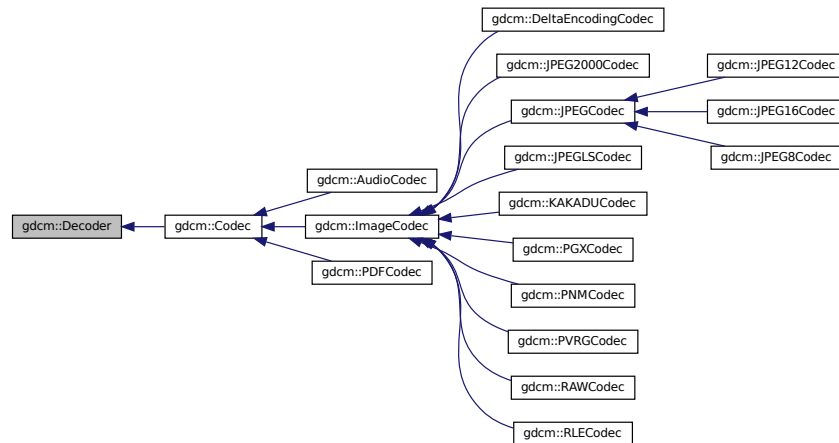

### Public Member Functions

- virtual `~Decoder()`=default
- virtual bool `CanDecode(TransferSyntax const &) const` =0  
*Return whether this decoder support this transfer syntax (can decode it)*
- virtual bool `Decode(DataElement const &, DataElement &)`  
*Decode.*

### Protected Member Functions

- virtual bool `DecodeByStreams(std::istream &, std::ostream &)`

#### 10.78.1 Detailed Description

[Decoder.](#)

#### 10.78.2 Constructor & Destructor Documentation

### 10.78.2.1 ~Decoder()

```
virtual gdcM::Decoder::~~Decoder ( ) [virtual], [default]
```

## 10.78.3 Member Function Documentation

### 10.78.3.1 CanDecode()

```
virtual bool gdcM::Decoder::CanDecode (
    TransferSyntax const & ) const [pure virtual]
```

Return whether this decoder support this transfer syntax (can decode it)

Implemented in [gdcM::RLECodec](#), [gdcM::RAWCodec](#), [gdcM::PVRGCodec](#), [gdcM::PNMCodec](#), [gdcM::PGXCodec](#), [gdcM::KAKADUCodec](#), [gdcM::JPEGLSCodec](#), [gdcM::JPEGCodec](#), [gdcM::JPEG2000Codec](#), [gdcM::PDFCodec](#), [gdcM::ImageCodec](#), and [gdcM::AudioCodec](#).

### 10.78.3.2 Decode()

```
virtual bool gdcM::Decoder::Decode (
    DataElement const & ,
    DataElement & ) [inline], [virtual]
```

Decode.

Reimplemented in [gdcM::ImageCodec](#), [gdcM::RLECodec](#), [gdcM::RAWCodec](#), [gdcM::PVRGCodec](#), [gdcM::PDFCodec](#), [gdcM::KAKADUCodec](#), [gdcM::JPEGLSCodec](#), [gdcM::JPEGCodec](#), [gdcM::JPEG2000Codec](#), [gdcM::AudioCodec](#), and [gdcM::DeltaEncodingCodec](#).

### 10.78.3.3 DecodeByStreams()

```
virtual bool gdcM::Decoder::DecodeByStreams (
    std::istream & ,
    std::ostream & ) [inline], [protected], [virtual]
```

Reimplemented in [gdcM::ImageCodec](#), [gdcM::RLECodec](#), [gdcM::RAWCodec](#), [gdcM::JPEGCodec](#), [gdcM::JPEG8Codec](#), [gdcM::JPEG2000Codec](#), [gdcM::JPEG16Codec](#), and [gdcM::JPEG12Codec](#).

The documentation for this class was generated from the following file:

- [gdcMDecoder.h](#)

## 10.79 gdcM::DefinedTerms Class Reference

Defined Terms are used when the specified explicit Values may be extended by implementors to include additional new Values. These new Values shall be specified in the Conformance Statement (see PS 3.2) and shall not have the same meaning as currently defined Values in this standard. A Data [Element](#) with Defined Terms that does not contain a [Value](#) equivalent to one of the Values currently specified in this standard shall not be considered to have an invalid value. Note: Interpretation [Type ID](#) (4008,0210) is an example of a Data [Element](#) having Defined Terms. It is defined to have a [Value](#) that may be one of the set of standard Values; REPORT or AMENDMENT (see PS 3.3). Because this Data [Element](#) has Defined Terms other Interpretation [Type](#) IDs may be defined by the implementor.

```
#include <gdcMDefinedTerms.h>
```

### Public Member Functions

- [DefinedTerms](#) ()=default

#### 10.79.1 Detailed Description

Defined Terms are used when the specified explicit Values may be extended by implementors to include additional new Values. These new Values shall be specified in the Conformance Statement (see PS 3.2) and shall not have the same meaning as currently defined Values in this standard. A Data [Element](#) with Defined Terms that does not contain a [Value](#) equivalent to one of the Values currently specified in this standard shall not be considered to have an invalid value. Note: Interpretation [Type ID](#) (4008,0210) is an example of a Data [Element](#) having Defined Terms. It is defined to have a [Value](#) that may be one of the set of standard Values; REPORT or AMENDMENT (see PS 3.3). Because this Data [Element](#) has Defined Terms other Interpretation [Type](#) IDs may be defined by the implementor.

#### 10.79.2 Constructor & Destructor Documentation

##### 10.79.2.1 DefinedTerms()

```
gdcM::DefinedTerms::DefinedTerms ( ) [default]
```

The documentation for this class was generated from the following file:

- [gdcMDefinedTerms.h](#)

## 10.80 gdcM::Defs Class Reference

FIXME I do not like the name '[Defs](#)'.

```
#include <gdcMDefs.h>
```

## Public Member Functions

- [Defs](#) ()
- [Defs](#) (const [Defs](#) &val)=delete
- [~Defs](#) ()
- const [IOD](#) & [GetIODFromFile](#) (const [File](#) &file) const
- [IODs](#) & [GetIODs](#) ()
- const [IODs](#) & [GetIODs](#) () const
- [Macros](#) & [GetMacros](#) ()
- const [Macros](#) & [GetMacros](#) () const
- [Modules](#) & [GetModules](#) ()
- const [Modules](#) & [GetModules](#) () const
- [Type](#) [GetTypeFromTag](#) (const [File](#) &file, const [Tag](#) &tag) const
- bool [IsEmpty](#) () const
- [Defs](#) & [operator=](#) (const [Defs](#) &val)=delete
- bool [Verify](#) (const [DataSet](#) &ds) const
- bool [Verify](#) (const [File](#) &file) const

## Static Public Member Functions

- static const char \* [GetIODNameFromMediaStorage](#) ([MediaStorage](#) const &ms)

## Protected Member Functions

- void [LoadDefaults](#) ()
- void [LoadFromFile](#) (const char \*filename)

## Friends

- class [Global](#)

### 10.80.1 Detailed Description

FIXME I do not like the name '[Defs](#)'.

#### Note

bla

#### Examples

[GenerateStandardSOPClasses.cxx](#).

### 10.80.2 Constructor & Destructor Documentation



### 10.80.2.1 Defs() [1/2]

```
gdcm::Defs::Defs ( )
```

### 10.80.2.2 ~Defs()

```
gdcm::Defs::~Defs ( )
```

### 10.80.2.3 Defs() [2/2]

```
gdcm::Defs::Defs (
    const Defs & val ) [delete]
```

## 10.80.3 Member Function Documentation

### 10.80.3.1 GetIODFromFile()

```
const IOD& gdcm::Defs::GetIODFromFile (
    const File & file ) const
```

### 10.80.3.2 GetIODNameFromMediaStorage()

```
static const char* gdcm::Defs::GetIODNameFromMediaStorage (
    MediaStorage const & ms ) [static]
```

#### Examples

[GenerateStandardSOPClasses.cxx](#).

### 10.80.3.3 GetIODs() [1/2]

```
IODs& gdcm::Defs::GetIODs ( ) [inline]
```

#### 10.80.3.4 GetIODs() [2/2]

```
const IODs& gdcm::Defs::GetIODs ( ) const [inline]
```

#### 10.80.3.5 GetMacros() [1/2]

```
Macros& gdcm::Defs::GetMacros ( ) [inline]
```

#### 10.80.3.6 GetMacros() [2/2]

```
const Macros& gdcm::Defs::GetMacros ( ) const [inline]
```

Users should not directly use [Macro](#). [Macro](#) are simply a way for DICOM WG to re-use Tables. [Macros](#) are conveniently wrapped within [Modules](#). See [gdcm::Module](#) API directly

#### 10.80.3.7 GetModules() [1/2]

```
Modules& gdcm::Defs::GetModules ( ) [inline]
```

#### 10.80.3.8 GetModules() [2/2]

```
const Modules& gdcm::Defs::GetModules ( ) const [inline]
```

#### 10.80.3.9 GetTypeFromTag()

```
Type gdcm::Defs::GetTypeFromTag (
    const File & file,
    const Tag & tag ) const
```

#### 10.80.3.10 IsEmpty()

```
bool gdcm::Defs::IsEmpty ( ) const [inline]
```

### 10.80.3.11 LoadDefaults()

```
void gdcm::Defs::LoadDefaults ( ) [protected]
```

### 10.80.3.12 LoadFromFile()

```
void gdcm::Defs::LoadFromFile (
    const char * filename ) [protected]
```

### 10.80.3.13 operator=()

```
Defs& gdcm::Defs::operator= (
    const Defs & val ) [delete]
```

### 10.80.3.14 Verify() [1/2]

```
bool gdcm::Defs::Verify (
    const DataSet & ds ) const
```

### 10.80.3.15 Verify() [2/2]

```
bool gdcm::Defs::Verify (
    const File & file ) const
```

## 10.80.4 Friends And Related Function Documentation

### 10.80.4.1 Global

```
friend class Global [friend]
```

The documentation for this class was generated from the following file:

- [gdcmDefs.h](#)

## 10.81 gdcm::DeltaEncodingCodec Class Reference

[DeltaEncodingCodec](#) compression used by some private vendor.

```
#include <gdcmDeltaEncodingCodec.h>
```

Inheritance diagram for `gdcm::DeltaEncodingCodec`:

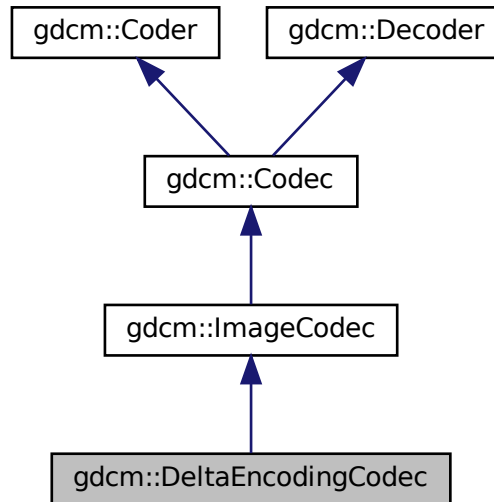

Collaboration diagram for `gdcm::DeltaEncodingCodec`:

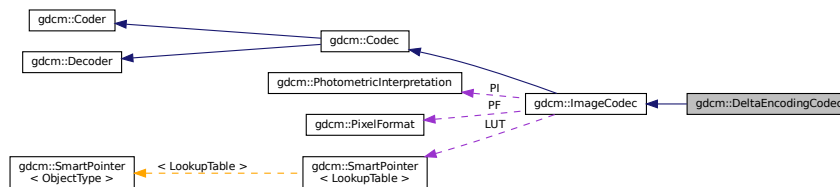

### Public Member Functions

- [DeltaEncodingCodec](#) ()
- [~DeltaEncodingCodec](#) ()
- `bool` [CanDecode](#) ([TransferSyntax](#) const &ts)
- `bool` [Decode](#) ([DataElement](#) const &is, [DataElement](#) &os)

*Decode.*

## Protected Member Functions

- bool [Decode](#) (std::istream &is, std::ostream &os)

## Additional Inherited Members

### 10.81.1 Detailed Description

[DeltaEncodingCodec](#) compression used by some private vendor.

### 10.81.2 Constructor & Destructor Documentation

#### 10.81.2.1 DeltaEncodingCodec()

```
gdcm::DeltaEncodingCodec::DeltaEncodingCodec ( )
```

#### 10.81.2.2 ~DeltaEncodingCodec()

```
gdcm::DeltaEncodingCodec::~~DeltaEncodingCodec ( )
```

### 10.81.3 Member Function Documentation

#### 10.81.3.1 CanDecode()

```
bool gdcm::DeltaEncodingCodec::CanDecode (
    TransferSyntax const & ts )
```

#### 10.81.3.2 Decode() [1/2]

```
bool gdcm::DeltaEncodingCodec::Decode (
    DataElement const & ,
    DataElement & ) [virtual]
```

Decode.

Reimplemented from [gdcm::Decoder](#).

### 10.81.3.3 Decode() [2/2]

```
bool gdcM::DeltaEncodingCodec::Decode (
    std::istream & is,
    std::ostream & os ) [protected]
```

The documentation for this class was generated from the following file:

- [gdcMDeltaEncodingCodec.h](#)

## 10.82 gdcM::DICOMDIR Class Reference

[DICOMDIR](#) class.

```
#include <gdcMDICOMDIR.h>
```

### Public Member Functions

- [DICOMDIR](#) ()=default
- [DICOMDIR](#) (FileSet fs)

### 10.82.1 Detailed Description

[DICOMDIR](#) class.

Structured for handling [DICOMDIR](#)

### 10.82.2 Constructor & Destructor Documentation

#### 10.82.2.1 DICOMDIR() [1/2]

```
gdcM::DICOMDIR::DICOMDIR ( ) [default]
```

#### 10.82.2.2 DICOMDIR() [2/2]

```
gdcM::DICOMDIR::DICOMDIR (
    FileSet fs ) [inline]
```

The documentation for this class was generated from the following file:

- [gdcMDICOMDIR.h](#)

## 10.83 gdcm::DICOMDIRGenerator Class Reference

[DICOMDIRGenerator](#) class.

```
#include <gdcmDICOMDIRGenerator.h>
```

### Public Types

- typedef [Directory::FileNamesType](#) FileNamesType
- typedef [Directory::FilenameType](#) FilenameType

### Public Member Functions

- [DICOMDIRGenerator](#) ()
- [~DICOMDIRGenerator](#) ()
- bool [Generate](#) ()  
*Main function to generate the [DICOMDIR](#).*
- [File](#) & [GetFile](#) ()
- void [SetDescriptor](#) (const char \*d)
- void [SetFile](#) (const [File](#) &f)  
*Set/Get file. The [DICOMDIR](#) file will be valid once a call to [Generate](#) has been done.*
- void [SetFileNames](#) ([FileNamesType](#) const &fns)  
*Set the list of filenames from which the [DICOMDIR](#) should be generated from.*
- void [SetRootDirectory](#) ([FilenameType](#) const &root)  
*Set the root directory from which the filenames should be considered.*

### Protected Member Functions

- bool [AddImageDirectoryRecord](#) ()
- bool [AddPatientDirectoryRecord](#) ()
- bool [AddSeriesDirectoryRecord](#) ()
- bool [AddStudyDirectoryRecord](#) ()
- [Scanner](#) & [GetScanner](#) ()

### 10.83.1 Detailed Description

[DICOMDIRGenerator](#) class.

This is a STD-GEN-CD [DICOMDIR](#) generator. ref: PS 3.11-2008 Annex D (Normative) - General Purpose CD-R and DVD Interchange Profiles

**Note**

PS 3.11 - 2008 / D.3.2 Physical Medium And Medium Format The STD-GEN-CD and STD-GEN-SEC-CD application profiles require the 120 mm CD-R physical medium with the ISO/IEC 9660 Media Format, as defined in PS3.12. See also PS 3.12 - 2008 / Annex F 120mm CD-R Medium (Normative) and PS 3.10 - 2008 / 8 DICOM [File Service / 8.1 FILE-SET](#)

**Warning**

: PS 3.11 - 2008 / D.3.1 SOP Classes and Transfer Syntaxes Composite [Image](#) & Stand-alone Storage are required to be stored as Explicit [VR](#) Little Endian Uncompressed (1.2.840.10008.1.2.1). When a DICOM file is found using another Transfer Syntax the generator will simply stops.

- Input files should be Explicit [VR](#) Little Endian
- filenames should be valid [VR::CS](#) value (16 bytes, upper case ...)

**Bug** : There is a current limitation of not handling Referenced SOP Class UID / Referenced SOP Instance UID simply because the [Scanner](#) does not allow us See PS 3.11 / [Table D.3-2 STD-GEN Additional DICOMDIR Keys](#)

## 10.83.2 Member Typedef Documentation

### 10.83.2.1 FilenamesType

```
typedef Directory::FilenamesType gdcm::DICOMDIRGenerator::FilenamesType
```

### 10.83.2.2 FilenameType

```
typedef Directory::FilenameType gdcm::DICOMDIRGenerator::FilenameType
```

## 10.83.3 Constructor & Destructor Documentation

### 10.83.3.1 DICOMDIRGenerator()

```
gdcm::DICOMDIRGenerator::DICOMDIRGenerator ( )
```



### 10.83.3.2 ~DICOMDIRGenerator()

```
gdcm::DICOMDIRGenerator::~~DICOMDIRGenerator ( )
```

## 10.83.4 Member Function Documentation

### 10.83.4.1 AddImageDirectoryRecord()

```
bool gdcm::DICOMDIRGenerator::AddImageDirectoryRecord ( ) [protected]
```

### 10.83.4.2 AddPatientDirectoryRecord()

```
bool gdcm::DICOMDIRGenerator::AddPatientDirectoryRecord ( ) [protected]
```

### 10.83.4.3 AddSeriesDirectoryRecord()

```
bool gdcm::DICOMDIRGenerator::AddSeriesDirectoryRecord ( ) [protected]
```

### 10.83.4.4 AddStudyDirectoryRecord()

```
bool gdcm::DICOMDIRGenerator::AddStudyDirectoryRecord ( ) [protected]
```

### 10.83.4.5 Generate()

```
bool gdcm::DICOMDIRGenerator::Generate ( )
```

Main function to generate the [DICOMDIR](#).

#### 10.83.4.6 GetFile()

```
File& gdcm::DICOMDIRGenerator::GetFile ( )
```

#### 10.83.4.7 GetScanner()

```
Scanner& gdcm::DICOMDIRGenerator::GetScanner ( ) [protected]
```

#### 10.83.4.8 SetDescriptor()

```
void gdcm::DICOMDIRGenerator::SetDescriptor (
    const char * d )
```

Set the [File](#) Set ID.

##### Warning

this need to be a valid [VR::CS](#) value

#### 10.83.4.9 SetFile()

```
void gdcm::DICOMDIRGenerator::SetFile (
    const File & f )
```

Set/Get file. The [DICOMDIR](#) file will be valid once a call to Generate has been done.

#### 10.83.4.10 SetFileNames()

```
void gdcm::DICOMDIRGenerator::SetFileNames (
    FileNamesType const & fns )
```

Set the list of filenames from which the [DICOMDIR](#) should be generated from.

### 10.83.4.11 SetRootDirectory()

```
void gdcM::DICOMDIRGenerator::SetRootDirectory (
    FilenameType const & root )
```

Set the root directory from which the filenames should be considered.

The documentation for this class was generated from the following file:

- [gdcM::DICOMDIRGenerator.h](#)

## 10.84 gdcM::Dict Class Reference

Class to represent a map of [DictEntry](#).

```
#include <gdcMDict.h>
```

### Public Types

- typedef MapDictEntry::const\_iterator [ConstIterator](#)
- typedef MapDictEntry::iterator [Iterator](#)
- typedef std::map< [Tag](#), [DictEntry](#) > [MapDictEntry](#)

### Public Member Functions

- [Dict](#) ()
- [Dict](#) (const [Dict](#) &\_val)=delete
- void [AddDictEntry](#) (const [Tag](#) &tag, const [DictEntry](#) &de)
- [ConstIterator](#) [Begin](#) () const
- [ConstIterator](#) [End](#) () const
- const [DictEntry](#) & [GetDictEntry](#) (const [Tag](#) &tag) const
- const [DictEntry](#) & [GetDictEntryByKeyword](#) (const char \*keyword, [Tag](#) &tag) const
- const [DictEntry](#) & [GetDictEntryByName](#) (const char \*name, [Tag](#) &tag) const
- const char \* [GetKeywordFromTag](#) ([Tag](#) const &tag) const
 

*Function to return the Keyword from a [Tag](#).*
- bool [IsEmpty](#) () const
- [Dict](#) & [operator=](#) (const [Dict](#) &\_val)=delete

### Protected Member Functions

- void [LoadDefault](#) ()

## Friends

- class [Dicts](#)
- `std::ostream & operator<<` (`std::ostream &_os, const Dict &_val`)

### 10.84.1 Detailed Description

Class to represent a map of [DictEntry](#).

#### Note

bla TODO FIXME: For [Element](#) == 0x0 need to return Name = Group Length ValueRepresentation = UL Value↔  
Multiplicity = 1

#### Examples

[GenAllVR.cxx](#), [GenFakeIdentifyFile.cxx](#), [PublicDict.cxx](#), and [ReadAndPrintAttributes.cxx](#).

### 10.84.2 Member Typedef Documentation

#### 10.84.2.1 ConstIterator

```
typedef MapDictEntry::const_iterator gdcM::Dict::ConstIterator
```

#### 10.84.2.2 Iterator

```
typedef MapDictEntry::iterator gdcM::Dict::Iterator
```

#### 10.84.2.3 MapDictEntry

```
typedef std::map<Tag, DictEntry> gdcM::Dict::MapDictEntry
```

### 10.84.3 Constructor & Destructor Documentation

### 10.84.3.1 Dict() [1/2]

```
gdcmm::Dict::Dict ( ) [inline]
```

### 10.84.3.2 Dict() [2/2]

```
gdcmm::Dict::Dict (
    const Dict & _val ) [delete]
```

## 10.84.4 Member Function Documentation

### 10.84.4.1 AddDictEntry()

```
void gdcmm::Dict::AddDictEntry (
    const Tag & tag,
    const DictEntry & de ) [inline]
```

### 10.84.4.2 Begin()

```
ConstIterator gdcmm::Dict::Begin ( ) const [inline]
```

#### Examples

[GenAllVR.cxx](#), and [GenFakeIdentifyFile.cxx](#).

### 10.84.4.3 End()

```
ConstIterator gdcmm::Dict::End ( ) const [inline]
```

#### Examples

[GenAllVR.cxx](#), and [GenFakeIdentifyFile.cxx](#).

#### 10.84.4.4 GetDictEntry()

```
const DictEntry& gdcM::Dict::GetDictEntry (
    const Tag & tag ) const [inline]
```

##### Examples

[GenFakelIdentifyFile.cxx](#), and [PublicDict.cxx](#).

#### 10.84.4.5 GetDictEntryByKeyword()

```
const DictEntry& gdcM::Dict::GetDictEntryByKeyword (
    const char * keyword,
    Tag & tag ) const [inline]
```

Lookup [DictEntry](#) by keyword. Even if DICOM standard defines keyword as being unique. The lookup table is built on [Tag](#). Therefore looking up a [DictEntry](#) by Keyword is more inefficient than looking up by [Tag](#).

#### 10.84.4.6 GetDictEntryByName()

```
const DictEntry& gdcM::Dict::GetDictEntryByName (
    const char * name,
    Tag & tag ) const [inline]
```

Inefficient way of looking up tag by name. Technically DICOM does not guarantee uniqueness (and [Curve / Overlay](#) are there to prove it). But most of the time name is in fact unique and can be uniquely link to a tag

##### Examples

[ReadAndPrintAttributes.cxx](#).

#### 10.84.4.7 GetKeywordFromTag()

```
const char* gdcM::Dict::GetKeywordFromTag (
    Tag const & tag ) const [inline]
```

Function to return the Keyword from a [Tag](#).

#### 10.84.4.8 IsEmpty()

```
bool gdcm::Dict::IsEmpty ( ) const [inline]
```

#### 10.84.4.9 LoadDefault()

```
void gdcm::Dict::LoadDefault ( ) [protected]
```

#### 10.84.4.10 operator=()

```
Dict& gdcm::Dict::operator= (
    const Dict & _val ) [delete]
```

### 10.84.5 Friends And Related Function Documentation

#### 10.84.5.1 Dicts

```
friend class Dicts [friend]
```

#### 10.84.5.2 operator<<

```
std::ostream& operator<< (
    std::ostream & _os,
    const Dict & _val ) [friend]
```

The documentation for this class was generated from the following file:

- [gdcmDict.h](#)

## 10.85 gdcm::DictConverter Class Reference

Class to convert a .dic file into something else:

```
#include <gdcmDictConverter.h>
```

## Public Types

- enum [OutputTypes](#) {  
    [DICT\\_DEFAULT](#) = 0 ,  
    [DICT\\_DEBUG](#) ,  
    [DICT\\_XML](#) }

## Public Member Functions

- [DictConverter](#) ()
- [~DictConverter](#) ()
- void [Convert](#) ()
- const std::string & [GetDictName](#) () const
- const std::string & [GetInputFilename](#) () const
- const std::string & [GetOutputFilename](#) () const
- int [GetOutputType](#) () const
- void [SetDictName](#) (const char \*name)
- void [SetInputFileName](#) (const char \*filename)
- void [SetOutputFileName](#) (const char \*filename)
- void [SetOutputType](#) (int type)

## Static Public Member Functions

- static bool [Readuint16](#) (const char \*raw, uint16\_t &ov)
- static bool [ReadVM](#) (const char \*raw, [VM::VMType](#) &type)
- static bool [ReadVR](#) (const char \*raw, [VR::VRType](#) &type)

## Protected Member Functions

- void [AddGroupLength](#) ()
- bool [ConvertToCXX](#) (const char \*raw, std::string &cxx)
- bool [ConvertToXML](#) (const char \*raw, std::string &cxx)
- void [WriteFooter](#) ()
- void [WriteHeader](#) ()

### 10.85.1 Detailed Description

Class to convert a .dic file into something else:

- CXX code : embed dict into shared lib ([DICT\\_DEFAULT](#))
- Debug mode ([DICT\\_DEBUG](#))
- XML dict ([DICT\\_XML](#))

Note



## 10.85.2 Member Enumeration Documentation

### 10.85.2.1 OutputTypes

```
enum gdcM::DictConverter::OutputTypes
```

Enumerator

DICT_DEFAULT	
DICT_DEBUG	
DICT_XML	

## 10.85.3 Constructor & Destructor Documentation

### 10.85.3.1 DictConverter()

```
gdcM::DictConverter::DictConverter ( )
```

### 10.85.3.2 ~DictConverter()

```
gdcM::DictConverter::~~DictConverter ( )
```

## 10.85.4 Member Function Documentation

### 10.85.4.1 AddGroupLength()

```
void gdcM::DictConverter::AddGroupLength ( ) [protected]
```

#### 10.85.4.2 Convert()

```
void gdcM::DictConverter::Convert ( )
```

#### 10.85.4.3 ConvertToCXX()

```
bool gdcM::DictConverter::ConvertToCXX (
    const char * raw,
    std::string & cxx ) [protected]
```

#### 10.85.4.4 ConvertToXML()

```
bool gdcM::DictConverter::ConvertToXML (
    const char * raw,
    std::string & cxx ) [protected]
```

#### 10.85.4.5 GetDictName()

```
const std::string& gdcM::DictConverter::GetDictName ( ) const
```

#### 10.85.4.6 GetInputFilename()

```
const std::string& gdcM::DictConverter::GetInputFilename ( ) const
```

#### 10.85.4.7 GetOutputFilename()

```
const std::string& gdcM::DictConverter::GetOutputFilename ( ) const
```

#### 10.85.4.8 GetOutputType()

```
int gdcM::DictConverter::GetOutputType ( ) const [inline]
```

#### 10.85.4.9 Readuint16()

```
static bool gdcM::DictConverter::Readuint16 (
    const char * raw,
    uint16_t & ov ) [static]
```

#### 10.85.4.10 ReadVM()

```
static bool gdcM::DictConverter::ReadVM (
    const char * raw,
    VM::VMType & type ) [static]
```

#### 10.85.4.11 ReadVR()

```
static bool gdcM::DictConverter::ReadVR (
    const char * raw,
    VR::VRType & type ) [static]
```

#### 10.85.4.12 SetDictName()

```
void gdcM::DictConverter::SetDictName (
    const char * name )
```

#### 10.85.4.13 SetInputFileName()

```
void gdcM::DictConverter::SetInputFileName (
    const char * filename )
```

#### 10.85.4.14 SetOutputFileName()

```
void gdcM::DictConverter::SetOutputFileName (
    const char * filename )
```

#### 10.85.4.15 SetOutputType()

```
void gdcM::DictConverter::SetOutputType (
    int type ) [inline]
```

#### 10.85.4.16 WriteFooter()

```
void gdcM::DictConverter::WriteFooter ( ) [protected]
```

#### 10.85.4.17 WriteHeader()

```
void gdcM::DictConverter::WriteHeader ( ) [protected]
```

The documentation for this class was generated from the following file:

- [gdcMDictConverter.h](#)

## 10.86 gdcM::DictEntry Class Reference

Class to represent an Entry in the [Dict](#).

```
#include <gdcMDictEntry.h>
```

### Public Member Functions

- [DictEntry](#) (const char \*name="", const char \*keyword="", [VR](#) const &vr=[VR::INVALID](#), [VM](#) const &vm=[VM::VM0](#), bool ret=false)
- const char \* [GetKeyword](#) () const  
*same as GetName but without spaces...*
- const char \* [GetName](#) () const  
*Set/Get Name.*
- bool [GetRetired](#) () const  
*Set/Get Retired flag.*
- const [VM](#) & [GetVM](#) () const  
*Set/Get VM.*
- const [VR](#) & [GetVR](#) () const  
*Set/Get VR.*
- bool [IsUnique](#) () const
- void [SetElementXX](#) (bool v)  
*Set whether element is shared in multiple elements (Source [Image](#) IDs typically)*
- void [SetGroupXX](#) (bool v)  
*Set whether element is shared in multiple groups (Curve/Overlay typically)*
- void [SetKeyword](#) (const char \*keyword)
- void [SetName](#) (const char \*name)
- void [SetRetired](#) (bool retired)
- void [SetVM](#) ([VM](#) const &vm)
- void [SetVR](#) (const [VR](#) &vr)

## Friends

- class [Dict](#)
- `std::ostream & operator<<` (`std::ostream &_os, const DictEntry &_val`)

### 10.86.1 Detailed Description

Class to represent an Entry in the [Dict](#).

Does not really exist within the DICOM definition, just a way to minimize storage and have a mapping from [gdcm::Tag](#) to the needed information

#### Note

bla TODO FIXME: Need a PublicDictEntry...indeed [DictEntry](#) has a notion of retired which does not exist in PrivateDictEntry...

#### See also

[gdcm::Dict](#)

#### Examples

[GenAllVR.cxx](#), [GenFakeIdentifyFile.cxx](#), and [PublicDict.cxx](#).

### 10.86.2 Constructor & Destructor Documentation

#### 10.86.2.1 DictEntry()

```
gdcm::DictEntry::DictEntry (  
    const char * name = "",  
    const char * keyword = "",  
    VR const & vr = VR::INVALID,  
    VM const & vm = VM::VMO,  
    bool ret = false ) [inline]
```

### 10.86.3 Member Function Documentation

### 10.86.3.1 GetKeyword()

```
const char* gdcM::DictEntry::GetKeyword ( ) const [inline]
```

same as GetName but without spaces...

### 10.86.3.2 GetName()

```
const char* gdcM::DictEntry::GetName ( ) const [inline]
```

Set/Get Name.

Referenced by gdcM::PrivateDict::PrintXML().

### 10.86.3.3 GetRetired()

```
bool gdcM::DictEntry::GetRetired ( ) const [inline]
```

Set/Get Retired flag.

#### Examples

[GenAllVR.cxx](#).

### 10.86.3.4 GetVM()

```
const VM& gdcM::DictEntry::GetVM ( ) const [inline]
```

Set/Get VM.

Referenced by gdcM::PrivateDict::AddDictEntry(), and gdcM::PrivateDict::PrintXML().

### 10.86.3.5 GetVR()

```
const VR& gdcM::DictEntry::GetVR ( ) const [inline]
```

Set/Get [VR](#).

#### Examples

[GenAllVR.cxx](#), and [GenFakeIdentifyFile.cxx](#).

Referenced by `gdcM::PrivateDict::AddDictEntry()`, and `gdcM::PrivateDict::PrintXML()`.

### 10.86.3.6 IsUnique()

```
bool gdcM::DictEntry::IsUnique ( ) const [inline]
```

Return whether the name of the [DataElement](#) can be considered to be unique. As of 2008 all elements name were unique (except the explicitly 'XX' ones)

### 10.86.3.7 SetElementXX()

```
void gdcM::DictEntry::SetElementXX (
    bool v ) [inline]
```

Set whether element is shared in multiple elements (Source [Image](#) IDs typically)

### 10.86.3.8 SetGroupXX()

```
void gdcM::DictEntry::SetGroupXX (
    bool v ) [inline]
```

Set whether element is shared in multiple groups (Curve/Overlay typically)

### 10.86.3.9 SetKeyword()

```
void gdcM::DictEntry::SetKeyword (
    const char * keyword ) [inline]
```

### 10.86.3.10 SetName()

```
void gdcM::DictEntry::SetName (
    const char * name ) [inline]
```

### 10.86.3.11 SetRetired()

```
void gdcM::DictEntry::SetRetired (
    bool retired ) [inline]
```

### 10.86.3.12 SetVM()

```
void gdcM::DictEntry::SetVM (
    VM const & vm ) [inline]
```

Referenced by gdcM::PrivateDict::AddDictEntry().

### 10.86.3.13 SetVR()

```
void gdcM::DictEntry::SetVR (
    const VR & vr ) [inline]
```

Referenced by gdcM::PrivateDict::AddDictEntry().

## 10.86.4 Friends And Related Function Documentation

### 10.86.4.1 Dict

```
friend class Dict [friend]
```



### 10.86.4.2 operator<<

```
std::ostream& operator<< (
    std::ostream & _os,
    const DictEntry & _val ) [friend]
```

The documentation for this class was generated from the following file:

- [gdcMDictEntry.h](#)

## 10.87 gdcM::DictPrinter Class Reference

[DictPrinter](#) class.

```
#include <gdcMDictPrinter.h>
```

Inheritance diagram for gdcM::DictPrinter:

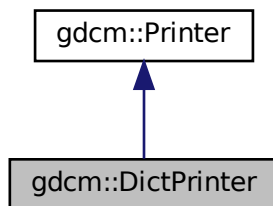

Collaboration diagram for `gdcM::DictPrinter`:

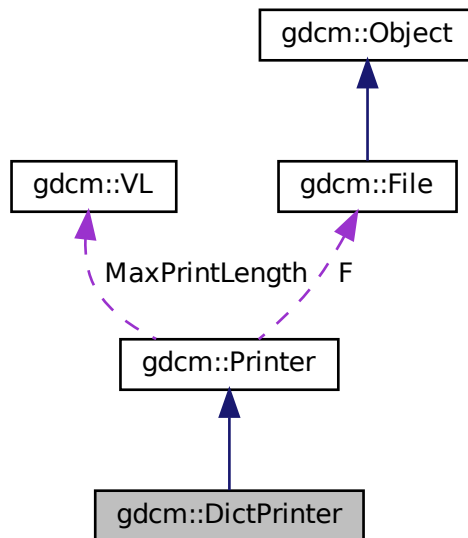

## Public Member Functions

- [DictPrinter](#) ()
- [~DictPrinter](#) ()
- void [Print](#) (std::ostream &os)

## Protected Member Functions

- void [PrintDataElement2](#) (std::ostream &os, const [DataSet](#) &ds, const [DataElement](#) &ide)
- void [PrintDataSet2](#) (std::ostream &os, const [DataSet](#) &ds)

## Additional Inherited Members

### 10.87.1 Detailed Description

[DictPrinter](#) class.

### 10.87.2 Constructor & Destructor Documentation

### 10.87.2.1 DictPrinter()

```
gdcM::DictPrinter::DictPrinter ( )
```

### 10.87.2.2 ~DictPrinter()

```
gdcM::DictPrinter::~~DictPrinter ( )
```

## 10.87.3 Member Function Documentation

### 10.87.3.1 Print()

```
void gdcM::DictPrinter::Print (
    std::ostream & os )
```

### 10.87.3.2 PrintDataElement2()

```
void gdcM::DictPrinter::PrintDataElement2 (
    std::ostream & os,
    const DataSet & ds,
    const DataElement & ide ) [protected]
```

### 10.87.3.3 PrintDataSet2()

```
void gdcM::DictPrinter::PrintDataSet2 (
    std::ostream & os,
    const DataSet & ds ) [protected]
```

The documentation for this class was generated from the following file:

- [gdcMDictPrinter.h](#)

## 10.88 gdcM::Dicts Class Reference

Class to manipulate the sum of knowledge (all the dict user load)

```
#include <gdcMDicts.h>
```

### Public Member Functions

- [Dicts](#) ()
- [Dicts](#) (const [Dicts](#) &\_val)=delete
- [~Dicts](#) ()
- const [CSAHeaderDict](#) & [GetCSAHeaderDict](#) () const
- const [DictEntry](#) & [GetDictEntry](#) (const [PrivateTag](#) &tag) const
- const [DictEntry](#) & [GetDictEntry](#) (const [Tag](#) &tag, const char \*owner=nullptr) const  
*THREAD SAFE.*
- [PrivateDict](#) & [GetPrivateDict](#) ()
- const [PrivateDict](#) & [GetPrivateDict](#) () const
- const [Dict](#) & [GetPublicDict](#) () const
- bool [IsEmpty](#) () const
- [Dicts](#) & [operator=](#) (const [Dicts](#) &\_val)=delete

### Protected Types

- enum [ConstructorType](#) {  
    [PHILIPS](#) ,  
    [GEMS](#) ,  
    [SIEMENS](#) }

### Protected Member Functions

- void [LoadDefaults](#) ()

### Static Protected Member Functions

- static const char \* [GetConstructorString](#) ([ConstructorType](#) type)

### Friends

- class [Global](#)
- std::ostream & [operator<<](#) (std::ostream &\_os, const [Dicts](#) &d)

## 10.88.1 Detailed Description

Class to manipulate the sum of knowledge (all the dict user load)

Note

bla

Examples

[GenAllVR.cxx](#), [GenFakeIdentifyFile.cxx](#), [PublicDict.cxx](#), and [ReadAndPrintAttributes.cxx](#).

## 10.88.2 Member Enumeration Documentation

### 10.88.2.1 ConstructorType

```
enum gdcM::Dicts::ConstructorType [protected]
```

Enumerator

PHILIPS	
GEMS	
SIEMENS	

## 10.88.3 Constructor & Destructor Documentation

### 10.88.3.1 Dicts() [1/2]

```
gdcM::Dicts::Dicts ( )
```

### 10.88.3.2 ~Dicts()

```
gdcM::Dicts::~~Dicts ( )
```

### 10.88.3.3 Dicts() [2/2]

```
gdcM::Dicts::Dicts (
    const Dicts & _val ) [delete]
```

## 10.88.4 Member Function Documentation

### 10.88.4.1 GetConstructorString()

```
static const char* gdcM::Dicts::GetConstructorString (
    ConstructorType type ) [static], [protected]
```

### 10.88.4.2 GetCSAHeaderDict()

```
const CSAHeaderDict& gdcM::Dicts::GetCSAHeaderDict ( ) const
```

#### Examples

[MrProtocol.cxx](#).

### 10.88.4.3 GetDictEntry() [1/2]

```
const DictEntry& gdcM::Dicts::GetDictEntry (
    const PrivateTag & tag ) const
```

### 10.88.4.4 GetDictEntry() [2/2]

```
const DictEntry& gdcM::Dicts::GetDictEntry (
    const Tag & tag,
    const char * owner = nullptr ) const
```

THREAD SAFE.

works for both public and private dicts: owner is null for public dict

#### Warning

owner need to be set to appropriate owner for call to work. see

#### Examples

[PublicDict.cxx](#).

#### 10.88.4.5 GetPrivateDict() [1/2]

```
PrivateDict& gdcM::Dicts::GetPrivateDict ( )
```

#### 10.88.4.6 GetPrivateDict() [2/2]

```
const PrivateDict& gdcM::Dicts::GetPrivateDict ( ) const
```

#### 10.88.4.7 GetPublicDict()

```
const Dict& gdcM::Dicts::GetPublicDict ( ) const
```

#### Examples

[GenAllVR.cxx](#), [GenFakeIdentifyFile.cxx](#), [PublicDict.cxx](#), and [ReadAndPrintAttributes.cxx](#).

#### 10.88.4.8 IsEmpty()

```
bool gdcM::Dicts::IsEmpty ( ) const [inline]
```

#### 10.88.4.9 LoadDefaults()

```
void gdcM::Dicts::LoadDefaults ( ) [protected]
```

#### 10.88.4.10 operator=()

```
Dicts& gdcM::Dicts::operator= (
    const Dicts & _val ) [delete]
```

### 10.88.5 Friends And Related Function Documentation

### 10.88.5.1 Global

```
friend class Global [friend]
```

### 10.88.5.2 operator<<

```
std::ostream& operator<< (  
    std::ostream & _os,  
    const Dicts & d ) [friend]
```

The documentation for this class was generated from the following file:

- [gdcMDicts.h](#)

## 10.89 gdcM::network::DIMSE Class Reference

DIMSE.

```
#include <gdcMDIMSE.h>
```

### Public Types

- enum [CommandTypes](#) {  
    C\_STORE\_RQ = 0x0001 ,  
    C\_STORE\_RSP = 0x8001 ,  
    C\_GET\_RQ = 0x0010 ,  
    C\_GET\_RSP = 0x8010 ,  
    C\_FIND\_RQ = 0x0020 ,  
    C\_FIND\_RSP = 0x8020 ,  
    C\_MOVE\_RQ = 0x0021 ,  
    C\_MOVE\_RSP = 0x8021 ,  
    C\_ECHO\_RQ = 0x0030 ,  
    C\_ECHO\_RSP = 0x8030 ,  
    N\_EVENT\_REPORT\_RQ = 0x0100 ,  
    N\_EVENT\_REPORT\_RSP = 0x8100 ,  
    N\_GET\_RQ = 0x0110 ,  
    N\_GET\_RSP = 0x8110 ,  
    N\_SET\_RQ = 0x0120 ,  
    N\_SET\_RSP = 0x8120 ,  
    N\_ACTION\_RQ = 0x0130 ,  
    N\_ACTION\_RSP = 0x8130 ,  
    N\_CREATE\_RQ = 0x0140 ,  
    N\_CREATE\_RSP = 0x8140 ,  
    N\_DELETE\_RQ = 0x0150 ,  
    N\_DELETE\_RSP = 0x8150 ,  
    C\_CANCEL\_RQ = 0x0FFF }



## 10.89.1 Detailed Description

DIMSE.

PS 3.7 - 2009 Annex E [Command Dictionary \(Normative\)](#) E.1 REGISTRY OF DICOM COMMAND ELEMENTS [Table E.1-1 COMMAND FIELDS \(PART 1\)](#)

## 10.89.2 Member Enumeration Documentation

### 10.89.2.1 CommandTypes

```
enum gdcmm::network::DIMSE::CommandTypes
```

Enumerator

C_STORE_RQ	
C_STORE_RSP	
C_GET_RQ	
C_GET_RSP	
C_FIND_RQ	
C_FIND_RSP	
C_MOVE_RQ	
C_MOVE_RSP	
C_ECHO_RQ	
C_ECHO_RSP	
N_EVENT_REPORT_RQ	
N_EVENT_REPORT_RSP	
N_GET_RQ	
N_GET_RSP	
N_SET_RQ	
N_SET_RSP	
N_ACTION_RQ	
N_ACTION_RSP	
N_CREATE_RQ	
N_CREATE_RSP	
N_DELETE_RQ	
N_DELETE_RSP	
C_CANCEL_RQ	

The documentation for this class was generated from the following file:

- [gdcmmDIMSE.h](#)

## 10.90 gdcM::DirectionCosines Class Reference

class to handle [DirectionCosines](#)

```
#include <gdcMDirectionCosines.h>
```

### Public Member Functions

- [DirectionCosines](#) ()
- [DirectionCosines](#) (const double dircos[6])
- [~DirectionCosines](#) ()
- double [ComputeDistAlongNormal](#) (const double ipp[3]) const  
*Compute the distance along the normal.*
- void [Cross](#) (double z[3]) const  
*Compute Cross product.*
- double [CrossDot](#) ([DirectionCosines](#) const &dc) const  
*Compute the Dot product of the two cross vector of both [DirectionCosines](#) object.*
- double [Dot](#) () const  
*Compute Dot.*
- bool [IsValid](#) () const  
*Return whether or not this is a valid direction cosines.*
- void [Normalize](#) ()  
*Normalize in-place.*
- [operator const double \\*](#) () const  
*Make the class behave like a const double \*.*
- void [Print](#) (std::ostream &) const  
*Print.*
- bool [SetFromString](#) (const char \*str)

### Static Public Member Functions

- static double [Dot](#) (const double x[3], const double y[3])  
*Compute Dot.*
- static void [Normalize](#) (double v[3])  
*Normalize in-place.*

### 10.90.1 Detailed Description

class to handle [DirectionCosines](#)

Examples

[DiscriminateVolume.cxx](#).

## 10.90.2 Constructor & Destructor Documentation

### 10.90.2.1 DirectionCosines() [1/2]

```
gdcM::DirectionCosines::DirectionCosines ( )
```

### 10.90.2.2 DirectionCosines() [2/2]

```
gdcM::DirectionCosines::DirectionCosines (
    const double dircos[6] )
```

### 10.90.2.3 ~DirectionCosines()

```
gdcM::DirectionCosines::~~DirectionCosines ( )
```

## 10.90.3 Member Function Documentation

### 10.90.3.1 ComputeDistAlongNormal()

```
double gdcM::DirectionCosines::ComputeDistAlongNormal (
    const double ipp[3] ) const
```

Compute the distance along the normal.

### 10.90.3.2 Cross()

```
void gdcM::DirectionCosines::Cross (
    double z[3] ) const
```

Compute Cross product.

### 10.90.3.3 CrossDot()

```
double gdcM::DirectionCosines::CrossDot (
    DirectionCosines const & dc ) const
```

Compute the Dot product of the two cross vector of both [DirectionCosines](#) object.

#### Examples

[DiscriminateVolume.cxx](#).

### 10.90.3.4 Dot() [1/2]

```
double gdcM::DirectionCosines::Dot ( ) const
```

Compute Dot.

### 10.90.3.5 Dot() [2/2]

```
static double gdcM::DirectionCosines::Dot (
    const double x[3],
    const double y[3] ) [static]
```

Compute Dot.

### 10.90.3.6 IsValid()

```
bool gdcM::DirectionCosines::IsValid ( ) const
```

Return whether or not this is a valid direction cosines.

### 10.90.3.7 Normalize() [1/2]

```
void gdcM::DirectionCosines::Normalize ( )
```

Normalize in-place.

### 10.90.3.8 Normalize() [2/2]

```
static void gdcm::DirectionCosines::Normalize (
    double v[3] ) [static]
```

Normalize in-place.

### 10.90.3.9 operator const double \*()

```
gdcm::DirectionCosines::operator const double * ( ) const [inline]
```

Make the class behave like a const double \*.

### 10.90.3.10 Print()

```
void gdcm::DirectionCosines::Print (
    std::ostream & ) const
```

Print.

### 10.90.3.11 SetFromString()

```
bool gdcm::DirectionCosines::SetFromString (
    const char * str )
```

Initialize from string str. It requires 6 floating point separated by a backslash character.

#### Examples

[DiscriminateVolume.cxx](#).

The documentation for this class was generated from the following file:

- [gdcmDirectionCosines.h](#)

## 10.91 gdcm::Directory Class Reference

Class for manipulation directories.

```
#include <gdcmDirectory.h>
```

## Public Types

- typedef std::vector< [FilenameType](#) > [FileNamesType](#)
- typedef std::string [FilenameType](#)

## Public Member Functions

- [Directory](#) ()=default
- [~Directory](#) ()=default
- [FileNamesType](#) const & [GetDirectories](#) () const  
*Return the Directories traversed.*
- [FileNamesType](#) const & [GetFileNames](#) () const  
*Set/Get the file names within the directory.*
- [FilenameType](#) const & [GetToplevel](#) () const  
*Get the name of the toplevel directory.*
- unsigned int [Load](#) ([FilenameType](#) const &name, bool recursive=false)
- void [Print](#) (std::ostream &os=std::cout) const  
*Print.*

## Protected Member Functions

- unsigned int [Explore](#) ([FilenameType](#) const &name, bool recursive)  
*Return number of file found when 'recursive'ly exploring directory name*

## Friends

- std::ostream & [operator<<](#) (std::ostream &\_os, const [Directory](#) &d)

### 10.91.1 Detailed Description

Class for manipulation directories.

#### Note

This implementation provide a cross platform implementation for manipulating directories: basically traversing directories and harvesting files

will not take into account unix type hidden file recursive option will not look into UNIX type hidden directory (those starting with a '.')

Since python or C# provide there own equivalent implementation, in which case [gdcmm::Directory](#) does not make much sense.

#### Examples

[DiscriminateVolume.cxx](#), [DumpToSQLITE3.cxx](#), [DumpVisusChange.cxx](#), [GenerateRTSTRUCT.cxx](#), [ReadUTF8QtDir.cxx](#), [SortImage.cxx](#), [VolumeSorter.cxx](#), [gdcmmorthoplanes.cxx](#), [reslicesphere.cxx](#), and [threadgdcmm.cxx](#).

## 10.91.2 Member Typedef Documentation

### 10.91.2.1 FilenamesType

```
typedef std::vector<FilenameType> gdcmm::Directory::FilenamesType
```

#### Examples

[DiscriminateVolume.cxx](#), and [GenerateRTSTRUCT.cxx](#).

### 10.91.2.2 FilenameType

```
typedef std::string gdcmm::Directory::FilenameType
```

## 10.91.3 Constructor & Destructor Documentation

### 10.91.3.1 Directory()

```
gdcmm::Directory::Directory ( ) [default]
```

### 10.91.3.2 ~Directory()

```
gdcmm::Directory::~~Directory ( ) [default]
```

## 10.91.4 Member Function Documentation

#### 10.91.4.1 Explore()

```
unsigned int gdcM::Directory::Explore (
    FilenameType const & name,
    bool recursive ) [protected]
```

Return number of file found when 'recursive'ly exploring directory name

#### 10.91.4.2 GetDirectories()

```
FilenameType const& gdcM::Directory::GetDirectories ( ) const [inline]
```

Return the Directories traversed.

#### 10.91.4.3 GetFileNames()

```
FilenameType const& gdcM::Directory::GetFileNames ( ) const [inline]
```

Set/Get the file names within the directory.

#### Examples

[DiscriminateVolume.cxx](#), [DumpToSQLITE3.cxx](#), [DumpVisusChange.cxx](#), [GenerateRTSTRUCT.cxx](#), [ReadUTF8QtDir.cxx](#), [SortImage.cxx](#), [VolumeSorter.cxx](#), [gdcMorthoplanes.cxx](#), [reslicesphere.cxx](#), and [threadgdcM.cxx](#).

#### 10.91.4.4 GetToplevel()

```
FilenameType const& gdcM::Directory::GetToplevel ( ) const [inline]
```

Get the name of the toplevel directory.



### 10.91.4.5 Load()

```
unsigned int gdcM::Directory::Load (
    FilenameType const & name,
    bool recursive = false )
```

construct a list of filenames and subdirectory beneath directory: name

#### Warning

: hidden file and hidden directory are not loaded.

#### Examples

[DecompressImageMultiframe.cs](#), [DiscriminateVolume.cxx](#), [DumpToSQLITE3.cxx](#), [DumpVisusChange.cxx](#), [GenerateRTSTRUCT.cxx](#), [ReadUTF8QtDir.cxx](#), [SortImage.cxx](#), [VolumeSorter.cxx](#), [gdcMorthoPlanes.cxx](#), [reslicesphere.cxx](#), and [threadgdcM.cxx](#).

### 10.91.4.6 Print()

```
void gdcM::Directory::Print (
    std::ostream & os = std::cout ) const
```

Print.

#### Examples

[SortImage.cxx](#).

## 10.91.5 Friends And Related Function Documentation

### 10.91.5.1 operator<<

```
std::ostream& operator<< (
    std::ostream & _os,
    const Directory & d ) [friend]
```

The documentation for this class was generated from the following file:

- [gdcMDirectory.h](#)

## 10.92 gdcm::DirectoryHelper Class Reference

[DirectoryHelper](#).

```
#include <gdcmDirectoryHelper.h>
```

### Static Public Member Functions

- static [Directory::FilenamesType GetCTImageSeriesUIDs](#) (const std::string &inDirectory)
- static [Directory::FilenamesType GetFilenamesFromSeriesUIDs](#) (const std::string &inDirectory, const std::string &inSeriesUID)
- static std::string [GetFrameOfReference](#) (const std::vector< [DataSet](#) > &inDS)
- static [Directory::FilenamesType GetMRImageSeriesUIDs](#) (const std::string &inDirectory)
- static [Directory::FilenamesType GetRTStructSeriesUIDs](#) (const std::string &inDirectory)
- static [Directory::FilenamesType GetSeriesUIDsBySOPClassUID](#) (const std::string &inDirectory, const std::string &inSOPClassUID)
- static std::string [GetSOPClassUID](#) (const std::vector< [DataSet](#) > &inDS)
- static std::string [GetStringValueFromTag](#) (const [Tag](#) &t, const [DataSet](#) &ds)
- static std::vector< [DataSet](#) > [LoadImageFromFiles](#) (const std::string &inDirectory, const std::string &inSeriesUID)
- static std::string [RetrieveSOPInstanceUIDFromIndex](#) (int inIndex, const std::vector< [DataSet](#) > &inDS)
- static std::string [RetrieveSOPInstanceUIDFromZPosition](#) (double inZPos, const std::vector< [DataSet](#) > &inDS)

### 10.92.1 Detailed Description

[DirectoryHelper](#).

this class is designed to help mitigate some of the commonly performed operations on directories. namely: 1) the ability to determine the number of series in a directory by what type of series is present 2) the ability to find all ct series in a directory 3) the ability to find all mr series in a directory 4) to load a set of DataSets from a series that's already been sorted by the IPP sorter 5) For rtstruct stuff, you need to know the sopinstanceuid of each z plane, so there's a retrieval function for that 6) then a few other functions for rtstruct writeouts

### 10.92.2 Member Function Documentation

#### 10.92.2.1 GetCTImageSeriesUIDs()

```
static Directory::FilenamesType gdcm::DirectoryHelper::GetCTImageSeriesUIDs (
    const std::string & inDirectory ) [static]
```

### 10.92.2.2 GetFileNamesFromSeriesUIDs()

```
static Directory::FileNamesType gdcm::DirectoryHelper::GetFileNamesFromSeriesUIDs (
    const std::string & inDirectory,
    const std::string & inSeriesUID ) [static]
```

#### Examples

[GenerateRTSTRUCT.cxx.](#)

### 10.92.2.3 GetFrameOfReference()

```
static std::string gdcm::DirectoryHelper::GetFrameOfReference (
    const std::vector< DataSet > & inDS ) [static]
```

### 10.92.2.4 GetMRImageSeriesUIDs()

```
static Directory::FileNamesType gdcm::DirectoryHelper::GetMRImageSeriesUIDs (
    const std::string & inDirectory ) [static]
```

### 10.92.2.5 GetRTStructSeriesUIDs()

```
static Directory::FileNamesType gdcm::DirectoryHelper::GetRTStructSeriesUIDs (
    const std::string & inDirectory ) [static]
```

#### Examples

[GenerateRTSTRUCT.cxx.](#)

### 10.92.2.6 GetSeriesUIDsBySOPClassUID()

```
static Directory::FileNamesType gdcm::DirectoryHelper::GetSeriesUIDsBySOPClassUID (
    const std::string & inDirectory,
    const std::string & inSOPClassUID ) [static]
```

### 10.92.2.7 GetSOPClassUID()

```
static std::string gdcm::DirectoryHelper::GetSOPClassUID (
    const std::vector< DataSet > & inDS ) [static]
```

### 10.92.2.8 GetStringValueFromTag()

```
static std::string gdcm::DirectoryHelper::GetStringValueFromTag (
    const Tag & t,
    const DataSet & ds ) [static]
```

### 10.92.2.9 LoadImageFromFiles()

```
static std::vector<DataSet> gdcm::DirectoryHelper::LoadImageFromFiles (
    const std::string & inDirectory,
    const std::string & inSeriesUID ) [static]
```

### 10.92.2.10 RetrieveSOPInstanceUIDFromIndex()

```
static std::string gdcm::DirectoryHelper::RetrieveSOPInstanceUIDFromIndex (
    int inIndex,
    const std::vector< DataSet > & inDS ) [static]
```

### 10.92.2.11 RetrieveSOPInstanceUIDFromZPosition()

```
static std::string gdcm::DirectoryHelper::RetrieveSOPInstanceUIDFromZPosition (
    double inZPos,
    const std::vector< DataSet > & inDS ) [static]
```

The documentation for this class was generated from the following file:

- [gdcmDirectoryHelper.h](#)

## 10.93 gdcm::DummyValueGenerator Class Reference

Class for generating dummy value.

```
#include <gdcmDummyValueGenerator.h>
```

## Static Public Member Functions

- static const char \* [Generate](#) (const char \*input)

### 10.93.1 Detailed Description

Class for generating dummy value.

See also

[Anonymizer](#)

### 10.93.2 Member Function Documentation

#### 10.93.2.1 Generate()

```
static const char* gdcM::DummyValueGenerator::Generate (  
    const char * input ) [static]
```

Generate a dummy value from an input value. This is guarantee to always return the same output value when input is identical. Return an array of bytes that can be used for anonymization purpose, return NULL on error NOT THREAD SAFE

The documentation for this class was generated from the following file:

- [gdcMDummyValueGenerator.h](#)

## 10.94 gdcM::Dumper Class Reference

[Codec](#) class.

```
#include <gdcMDumper.h>
```

Inheritance diagram for gdcM::Dumper:

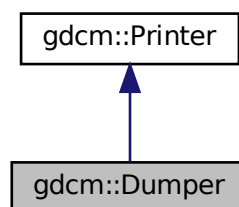

Collaboration diagram for `gdc::Dumper`:

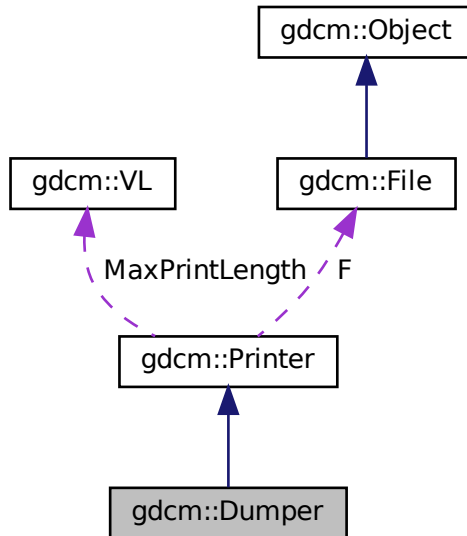

## Public Member Functions

- [Dumper](#) ()
- [~Dumper](#) ()=default

## Additional Inherited Members

### 10.94.1 Detailed Description

[Codec](#) class.

#### Note

Use it to simply dump value read from the file. No interpretation is done. But it is real fast ! Almost no overhead

### 10.94.2 Constructor & Destructor Documentation

## 10.94.2.1 Dumper()

```
gdcM::Dumper::Dumper ( ) [inline]
```

## 10.94.2.2 ~Dumper()

```
gdcM::Dumper::~~Dumper ( ) [default]
```

The documentation for this class was generated from the following file:

- [gdcMDumper.h](#)

## 10.95 gdcM::Element&lt; TVR, TVM &gt; Class Template Reference

[Element](#) class.

```
#include <gdcMElement.h>
```

Inheritance diagram for gdcM::Element< TVR, TVM >:

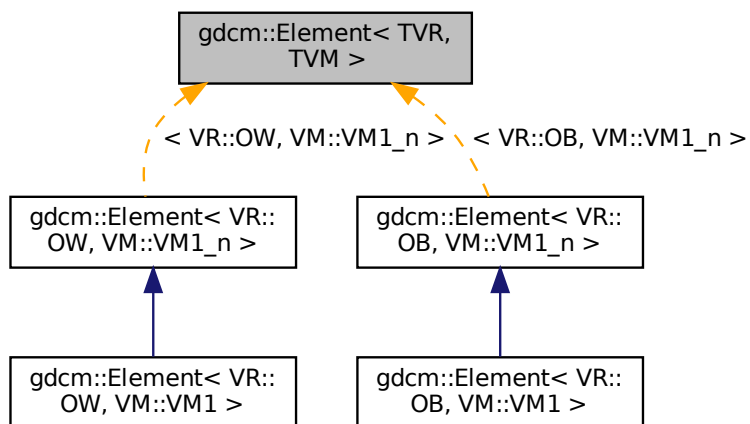

Collaboration diagram for `gdcm::Element< TVR, TVM >`:

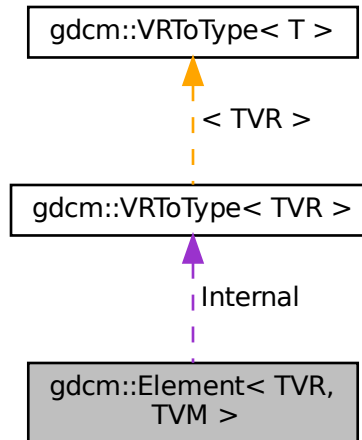

## Public Types

- typedef `VRTToType< TVR >::Type` `Type`

## Public Member Functions

- `DataElement` `GetAsDataElement` () const
- unsigned long `GetLength` () const
- `VRTToType< TVR >::Type` & `GetValue` (unsigned int idx=0)
- const `VRTToType< TVR >::Type` & `GetValue` (unsigned int idx=0) const
- const `VRTToType< TVR >::Type` \* `GetValues` () const
- `VRTToType< TVR >::Type` `operator[]` (unsigned int idx) const
- void `Print` (std::ostream &\_os) const
- void `Read` (std::istream &\_is)
- void `Set` (`Value` const &v)
- void `SetFromDataElement` (`DataElement` const &de)
- void `SetValue` (typename `VRTToType< TVR >::Type` v, unsigned int idx=0)
- void `Write` (std::ostream &\_os) const

## Static Public Member Functions

- static `VM` `GetVM` ()
- static `VR` `GetVR` ()



## Public Attributes

- [VRToType](#)< TVR >::Type Internal [[VMToLength](#)< TVM >::Length]

## Protected Member Functions

- void [SetNoSwap](#) (Value const &v)

### 10.95.1 Detailed Description

```
template<long long TVR, int TVM>
class gdcM::Element< TVR, TVM >
```

[Element](#) class.

#### Note

TODO

#### Examples

[DumpADAC.cxx](#), [DumpExamCard.cxx](#), [DumpGEMSMovieGroup.cxx](#), [Extracting\\_All\\_Resolution.cxx](#), [Fake\\_Image\\_Using\\_Stream\\_Image\\_Writer.cxx](#), [csa2img.cxx](#), and [iU22tomultisc.cxx](#).

### 10.95.2 Member Typedef Documentation

#### 10.95.2.1 Type

```
template<long long TVR, int TVM>
typedef VRToType<TVR>::Type gdcM::Element< TVR, TVM >::Type
```

### 10.95.3 Member Function Documentation

#### 10.95.3.1 GetAsDataElement()

```
template<long long TVR, int TVM>
DataElement gdcM::Element< TVR, TVM >::GetAsDataElement ( ) const [inline]
```

#### Examples

[Extracting\\_All\\_Resolution.cxx](#), and [Fake\\_Image\\_Using\\_Stream\\_Image\\_Writer.cxx](#).

References [gdcM::DataElement::GetVR\(\)](#), [gdcM::DataElement::SetByteValue\(\)](#), and [gdcM::DataElement::SetVR\(\)](#).

### 10.95.3.2 GetLength()

```
template<long long TVR, int TVM>
unsigned long gdcM::Element< TVR, TVM >::GetLength ( ) const [inline]
```

#### Examples

[DumpGEMSMovieGroup.cxx](#).

### 10.95.3.3 GetValue() [1/2]

```
template<long long TVR, int TVM>
VRToType<TVR>::Type& gdcM::Element< TVR, TVM >::GetValue (
    unsigned int idx = 0 ) [inline]
```

### 10.95.3.4 GetValue() [2/2]

```
template<long long TVR, int TVM>
const VRToType<TVR>::Type& gdcM::Element< TVR, TVM >::GetValue (
    unsigned int idx = 0 ) const [inline]
```

#### Examples

[DumpADAC.cxx](#), [DumpExamCard.cxx](#), [DumpGEMSMovieGroup.cxx](#), and [csa2img.cxx](#).

### 10.95.3.5 GetValues()

```
template<long long TVR, int TVM>
const VRToType<TVR>::Type* gdcM::Element< TVR, TVM >::GetValues ( ) const [inline]
```

### 10.95.3.6 GetVM()

```
template<long long TVR, int TVM>
static VM gdcM::Element< TVR, TVM >::GetVM ( ) [inline], [static]
```

### 10.95.3.7 GetVR()

```
template<long long TVR, int TVM>
static VR gdcmm::Element< TVR, TVM >::GetVR ( ) [inline], [static]
```

### 10.95.3.8 operator[]()

```
template<long long TVR, int TVM>
VRToType<TVR>::Type gdcmm::Element< TVR, TVM >::operator[] (
    unsigned int idx ) const [inline]
```

### 10.95.3.9 Print()

```
template<long long TVR, int TVM>
void gdcmm::Element< TVR, TVM >::Print (
    std::ostream & _os ) const [inline]
```

#### Examples

[DumpGEMSMovieGroup.cxx](#).

### 10.95.3.10 Read()

```
template<long long TVR, int TVM>
void gdcmm::Element< TVR, TVM >::Read (
    std::istream & _is ) [inline]
```

### 10.95.3.11 Set()

```
template<long long TVR, int TVM>
void gdcmm::Element< TVR, TVM >::Set (
    Value const & v ) [inline]
```

#### Examples

[csa2img.cxx](#).

References [gdcmm::ByteValue::GetLength\(\)](#), and [gdcmm::ByteValue::GetPointer\(\)](#).

### 10.95.3.12 SetFromDataElement()

```
template<long long TVR, int TVM>
void gdcM::Element< TVR, TVM >::SetFromDataElement (
    DataElement< TVR, TVM > const & de ) [inline]
```

#### Examples

[DumpADAC.cxx](#), [DumpExamCard.cxx](#), [DumpGEMSMovieGroup.cxx](#), and [iU22tomultisc.cxx](#).

References [gdcM::DataElement::GetByteValue\(\)](#), [gdcM::DataElement::GetValue\(\)](#), and [gdcM::DataElement::GetVR\(\)](#).

### 10.95.3.13 SetNoSwap()

```
template<long long TVR, int TVM>
void gdcM::Element< TVR, TVM >::SetNoSwap (
    Value const & v ) [inline], [protected]
```

References [gdcM::ByteValue::GetLength\(\)](#), and [gdcM::ByteValue::GetPointer\(\)](#).

### 10.95.3.14 SetValue()

```
template<long long TVR, int TVM>
void gdcM::Element< TVR, TVM >::SetValue (
    typename VRTToType< TVR >::Type v,
    unsigned int idx = 0 ) [inline]
```

#### Examples

[Extracting\\_All\\_Resolution.cxx](#), and [Fake\\_Image\\_Using\\_Stream\\_Image\\_Writer.cxx](#).

### 10.95.3.15 Write()

```
template<long long TVR, int TVM>
void gdcM::Element< TVR, TVM >::Write (
    std::ostream & _os ) const [inline]
```

## 10.95.4 Member Data Documentation

### 10.95.4.1 Internal

```
template<long long TVR, int TVM>  
VRToType<TVR>::Type gdcM::Element< TVR, TVM >::Internal[VMToLength< TVM >::Length]
```

The documentation for this class was generated from the following file:

- [gdcMElement.h](#)

## 10.96 gdcM::Element< TVR, VM::VM1\_2 > Class Template Reference

```
#include <gdcMElement.h>
```

Inheritance diagram for gdcM::Element< TVR, VM::VM1\_2 >:

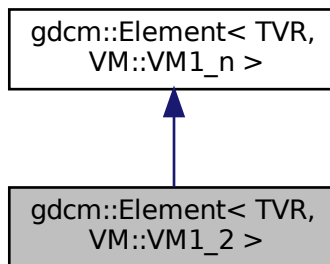

Collaboration diagram for gdcM::Element< TVR, VM::VM1\_2 >:

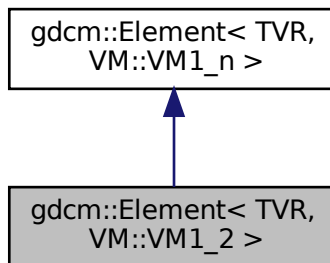

## Public Types

- typedef [Element](#)< TVR, VM::VM1\_n > [Parent](#)

## Public Member Functions

- void [SetLength](#) (int len)

## Additional Inherited Members

### 10.96.1 Member Typedef Documentation

#### 10.96.1.1 Parent

```
template<long long TVR>
typedef Element<TVR, VM::VM1_n> gdcmm::Element< TVR, VM::VM1_2 >::Parent
```

### 10.96.2 Member Function Documentation

#### 10.96.2.1 SetLength()

```
template<long long TVR>
void gdcmm::Element< TVR, VM::VM1_2 >::SetLength (
    int len ) [inline]
```

The documentation for this class was generated from the following file:

- [gdcmmElement.h](#)

## 10.97 gdcM::Element< TVR, VM::VM1\_n > Class Template Reference

```
#include <gdcMElement.h>
```

Inheritance diagram for gdcM::Element< TVR, VM::VM1\_n >:

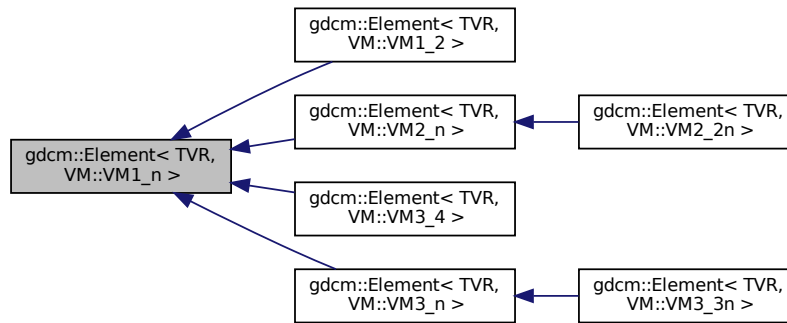

### Public Types

- typedef [VRToType< TVR >::Type](#) [Type](#)

### Public Member Functions

- [Element](#) ()
- [Element](#) (const [Element](#) &\_val)
- [~Element](#) ()
- [DataElement](#) [GetAsDataElement](#) () const
- unsigned long [GetLength](#) () const
- [VRToType< TVR >::Type](#) & [GetValue](#) (unsigned int idx=0)
- const [VRToType< TVR >::Type](#) & [GetValue](#) (unsigned int idx=0) const
- [Element](#) & [operator=](#) (const [Element](#) &\_val)
- [VRToType< TVR >::Type](#) [operator\[\]](#) (unsigned int idx) const
- void [Print](#) (std::ostream &\_os) const
- void [Read](#) (std::istream &\_is)
- void [Set](#) ([Value](#) const &v)
- void [SetArray](#) (const [Type](#) \*array, unsigned long len, bool save=false)
- void [SetFromDataElement](#) ([DataElement](#) const &de)
- void [SetLength](#) (unsigned long len)
- void [SetValue](#) (typename [VRToType< TVR >::Type](#) v, unsigned int idx=0)
- void [Write](#) (std::ostream &\_os) const
- void [WriteASCII](#) (std::ostream &os) const

## Static Public Member Functions

- static [VM GetVM](#) ()
- static [VR GetVR](#) ()

## Protected Member Functions

- void [SetNoSwap](#) ([Value](#) const &v)

## 10.97.1 Member Typedef Documentation

### 10.97.1.1 Type

```
template<long long TVR>
typedef VRToType<TVR>::Type gdcmm::Element< TVR, VM::VM1\_n >::Type
```

## 10.97.2 Constructor & Destructor Documentation

### 10.97.2.1 [Element\(\)](#) [1/2]

```
template<long long TVR>
gdcmm::Element< TVR, VM::VM1\_n >::Element ( ) [inline], [explicit]
```

### 10.97.2.2 [~Element\(\)](#)

```
template<long long TVR>
gdcmm::Element< TVR, VM::VM1\_n >::~~Element ( ) [inline]
```

### 10.97.2.3 [Element\(\)](#) [2/2]

```
template<long long TVR>
gdcmm::Element< TVR, VM::VM1\_n >::Element (
    const Element< TVR, VM::VM1\_n > &_val ) [inline]
```



## 10.97.3 Member Function Documentation

### 10.97.3.1 GetAsDataElement()

```
template<long long TVR>
DataElement gdcm::Element< TVR, VM::VM1_n >::GetAsDataElement ( ) const [inline]
```

References `gdcm::DataElement::GetVR()`, `gdcm::DataElement::SetByteValue()`, and `gdcm::DataElement::SetVR()`.

### 10.97.3.2 GetLength()

```
template<long long TVR>
unsigned long gdcm::Element< TVR, VM::VM1_n >::GetLength ( ) const [inline]
```

### 10.97.3.3 GetValue() [1/2]

```
template<long long TVR>
VRToType<TVR>::Type& gdcm::Element< TVR, VM::VM1_n >::GetValue (
    unsigned int idx = 0 ) [inline]
```

### 10.97.3.4 GetValue() [2/2]

```
template<long long TVR>
const VRToType<TVR>::Type& gdcm::Element< TVR, VM::VM1_n >::GetValue (
    unsigned int idx = 0 ) const [inline]
```

### 10.97.3.5 GetVM()

```
template<long long TVR>
static VM gdcm::Element< TVR, VM::VM1_n >::GetVM ( ) [inline], [static]
```

### 10.97.3.6 GetVR()

```
template<long long TVR>
static VR gdcM::Element< TVR, VM::VM1_n >::GetVR ( ) [inline], [static]
```

### 10.97.3.7 operator=()

```
template<long long TVR>
Element& gdcM::Element< TVR, VM::VM1_n >::operator= (
    const Element< TVR, VM::VM1_n > &_val ) [inline]
```

### 10.97.3.8 operator[]()

```
template<long long TVR>
VRToType<TVR>::Type gdcM::Element< TVR, VM::VM1_n >::operator[] (
    unsigned int idx ) const [inline]
```

### 10.97.3.9 Print()

```
template<long long TVR>
void gdcM::Element< TVR, VM::VM1_n >::Print (
    std::ostream &_os ) const [inline]
```

### 10.97.3.10 Read()

```
template<long long TVR>
void gdcM::Element< TVR, VM::VM1_n >::Read (
    std::istream &_is ) [inline]
```

### 10.97.3.11 Set()

```
template<long long TVR>
void gdcM::Element< TVR, VM::VM1_n >::Set (
    Value const &v ) [inline]
```

References `gdcM::ByteValue::GetLength()`, `gdcM::ByteValue::GetPointer()`, `gdcM::ByteValue::GetVoidPointer()`, and `gdcM::VRBINARY`.

### 10.97.3.12 SetArray()

```
template<long long TVR>
void gdcm::Element< TVR, VM::VM1_n >::SetArray (
    const Type * array,
    unsigned long len,
    bool save = false ) [inline]
```

### 10.97.3.13 SetFromDataElement()

```
template<long long TVR>
void gdcm::Element< TVR, VM::VM1_n >::SetFromDataElement (
    DataElement< TVR, VM::VM1_n > const & de ) [inline]
```

References `gdcm::DataElement::GetByteValue()`, `gdcm::DataElement::GetValue()`, and `gdcm::DataElement::GetVR()`.

### 10.97.3.14 SetLength()

```
template<long long TVR>
void gdcm::Element< TVR, VM::VM1_n >::SetLength (
    unsigned long len ) [inline]
```

### 10.97.3.15 SetNoSwap()

```
template<long long TVR>
void gdcm::Element< TVR, VM::VM1_n >::SetNoSwap (
    Value const & v ) [inline], [protected]
```

References `gdcm::ByteValue::GetLength()`, `gdcm::ByteValue::GetPointer()`, and `gdcm::VRBINARY`.

### 10.97.3.16 SetValue()

```
template<long long TVR>
void gdcm::Element< TVR, VM::VM1_n >::SetValue (
    typename VRToType< TVR >::Type v,
    unsigned int idx = 0 ) [inline]
```

**10.97.3.17 Write()**

```
template<long long TVR>
void gdcM::Element< TVR, VM::VM1_n >::Write (
    std::ostream & _os ) const [inline]
```

**10.97.3.18 WriteASCII()**

```
template<long long TVR>
void gdcM::Element< TVR, VM::VM1_n >::WriteASCII (
    std::ostream & os ) const [inline]
```

The documentation for this class was generated from the following file:

- [gdcMElement.h](#)

**10.98 gdcM::Element< TVR, VM::VM2\_2n > Class Template Reference**

```
#include <gdcMElement.h>
```

Inheritance diagram for gdcM::Element< TVR, VM::VM2\_2n >:

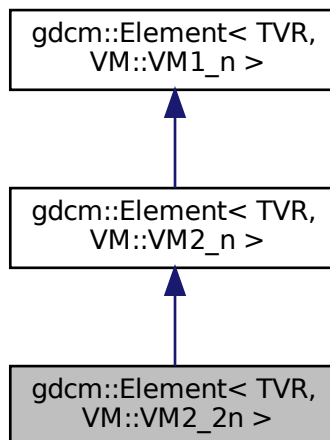

Collaboration diagram for gdcM::Element< TVR, VM::VM2\_2n >:

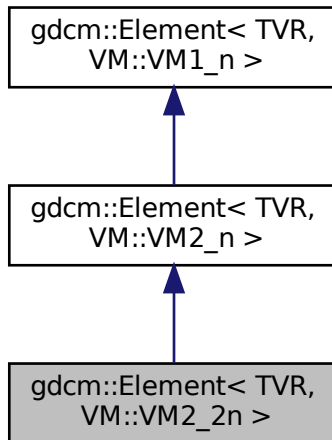

## Public Types

- typedef `Element< TVR, VM::VM2_n >` `Parent`

## Public Member Functions

- void `SetLength` (int len)

## Additional Inherited Members

### 10.98.1 Member Typedef Documentation

#### 10.98.1.1 Parent

```
template<long long TVR>
typedef Element<TVR, VM::VM2_n> gdcM::Element< TVR, VM::VM2_2n >::Parent
```

### 10.98.2 Member Function Documentation

### 10.98.2.1 SetLength()

```
template<long long TVR>
void gdcM::Element< TVR, VM::VM2_2n >::SetLength (
    int len ) [inline]
```

The documentation for this class was generated from the following file:

- [gdcMElement.h](#)

## 10.99 gdcM::Element< TVR, VM::VM2\_n > Class Template Reference

```
#include <gdcMElement.h>
```

Inheritance diagram for gdcM::Element< TVR, VM::VM2\_n >:

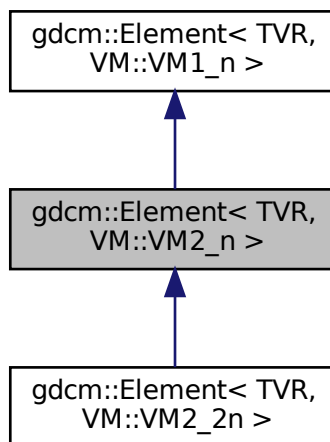

Collaboration diagram for gdcM::Element< TVR, VM::VM2\_n >:

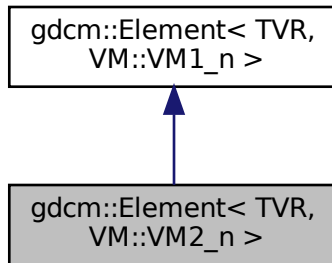

## Public Types

- typedef `Element< TVR, VM::VM1_n >` `Parent`

## Public Member Functions

- void `SetLength` (int len)

## Additional Inherited Members

### 10.99.1 Member Typedef Documentation

#### 10.99.1.1 Parent

```
template<long long TVR>
typedef Element<TVR, VM::VM1_n> gdcM::Element< TVR, VM::VM2_n >::Parent
```

### 10.99.2 Member Function Documentation

### 10.99.2.1 SetLength()

```
template<long long TVR>
void gdcM::Element< TVR, VM::VM2_n >::SetLength (
    int len ) [inline]
```

The documentation for this class was generated from the following file:

- [gdcMElement.h](#)

## 10.100 gdcM::Element< TVR, VM::VM3\_3n > Class Template Reference

```
#include <gdcMElement.h>
```

Inheritance diagram for gdcM::Element< TVR, VM::VM3\_3n >:

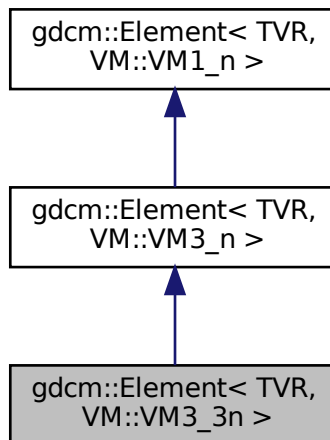



Collaboration diagram for gdcM::Element< TVR, VM::VM3\_3n >:

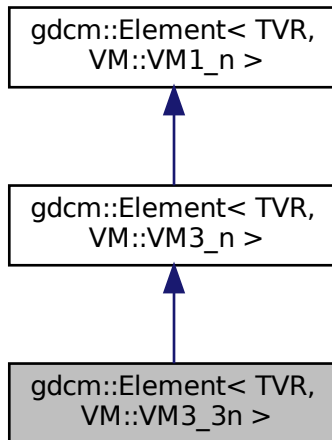

## Public Types

- typedef `Element< TVR, VM::VM3_n >` `Parent`

## Public Member Functions

- void `SetLength` (int len)

## Additional Inherited Members

### 10.100.1 Member Typedef Documentation

#### 10.100.1.1 Parent

```
template<long long TVR>
typedef Element<TVR, VM::VM3_n> gdcM::Element< TVR, VM::VM3_3n >::Parent
```

### 10.100.2 Member Function Documentation

### 10.100.2.1 SetLength()

```
template<long long TVR>
void gdcElement< TVR, VM::VM3_3n >::SetLength (
    int len ) [inline]
```

The documentation for this class was generated from the following file:

- [gdcElement.h](#)

## 10.101 gdcElement< TVR, VM::VM3\_4 > Class Template Reference

```
#include <gdcElement.h>
```

Inheritance diagram for gdcElement< TVR, VM::VM3\_4 >:

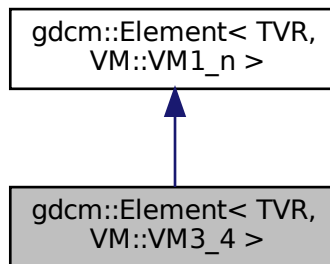

Collaboration diagram for gdcElement< TVR, VM::VM3\_4 >:

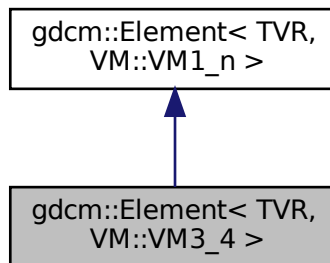

## Public Types

- typedef `Element< TVR, VM::VM1_n >` `Parent`

## Public Member Functions

- void `SetLength` (int len)

## Additional Inherited Members

### 10.101.1 Member Typedef Documentation

#### 10.101.1.1 Parent

```
template<long long TVR>
typedef Element<TVR, VM::VM1_n> gdcElement< TVR, VM::VM3_4 >::Parent
```

### 10.101.2 Member Function Documentation

#### 10.101.2.1 SetLength()

```
template<long long TVR>
void gdcElement< TVR, VM::VM3_4 >::SetLength (
    int len ) [inline]
```

The documentation for this class was generated from the following file:

- [gdcElement.h](#)

## 10.102 gdcM::Element< TVR, VM::VM3\_n > Class Template Reference

```
#include <gdcMElement.h>
```

Inheritance diagram for gdcM::Element< TVR, VM::VM3\_n >:

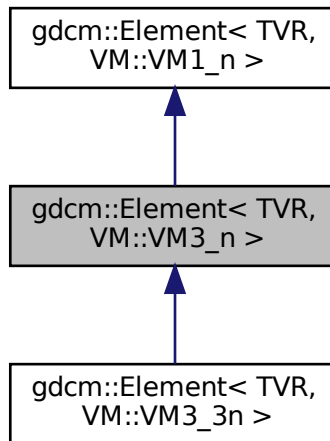

Collaboration diagram for gdcM::Element< TVR, VM::VM3\_n >:

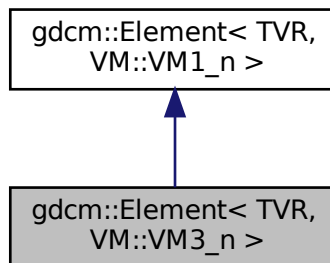

### Public Types

- typedef [Element< TVR, VM::VM1\\_n >](#) Parent

## Public Member Functions

- void [SetLength](#) (int len)

## Additional Inherited Members

### 10.102.1 Member Typedef Documentation

#### 10.102.1.1 Parent

```
template<long long TVR>
typedef Element<TVR, VM::VM1_n> gdcmm::Element< TVR, VM::VM3_n >::Parent
```

### 10.102.2 Member Function Documentation

#### 10.102.2.1 SetLength()

```
template<long long TVR>
void gdcmm::Element< TVR, VM::VM3_n >::SetLength (
    int len ) [inline]
```

The documentation for this class was generated from the following file:

- [gdcmmElement.h](#)

## 10.103 `gdcmm::Element< VR::AS, VM::VM5 >` Class Reference

```
#include <gdcmmElement.h>
```

## Public Member Functions

- unsigned long [GetLength](#) () const
- void [Print](#) (std::ostream &\_os) const

## Public Attributes

- char [Internal](#) [[VMToLength](#)< VM::VM5 >::Length \*sizeof([VRToType](#)< VR::AS >::Type)]

## 10.103.1 Member Function Documentation

### 10.103.1.1 GetLength()

```
unsigned long gdcM::Element< VR::AS, VM::VM5 >::GetLength ( ) const [inline]
```

### 10.103.1.2 Print()

```
void gdcM::Element< VR::AS, VM::VM5 >::Print (
    std::ostream & _os ) const [inline]
```

## 10.103.2 Member Data Documentation

### 10.103.2.1 Internal

```
char gdcM::Element< VR::AS, VM::VM5 >::Internal[VMToLength< VM::VM5 >::Length *sizeof(VRToType<
VR::AS >::Type)]
```

The documentation for this class was generated from the following file:

- [gdcMElement.h](#)

## 10.104 gdcM::Element< VR::OB, VM::VM1 > Class Reference

```
#include <gdcMElement.h>
```

Inheritance diagram for gdcM::Element< VR::OB, VM::VM1 >:

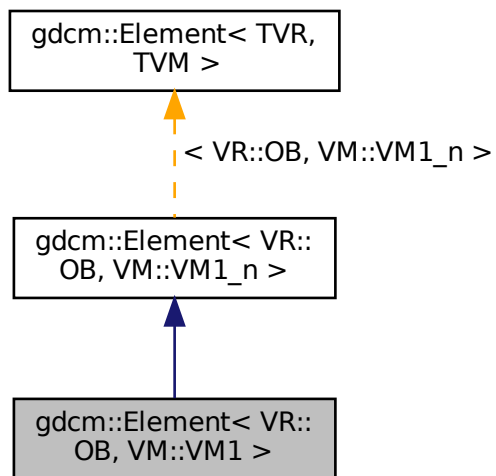

Collaboration diagram for `gdcM::Element< VR::OB, VM::VM1 >`:

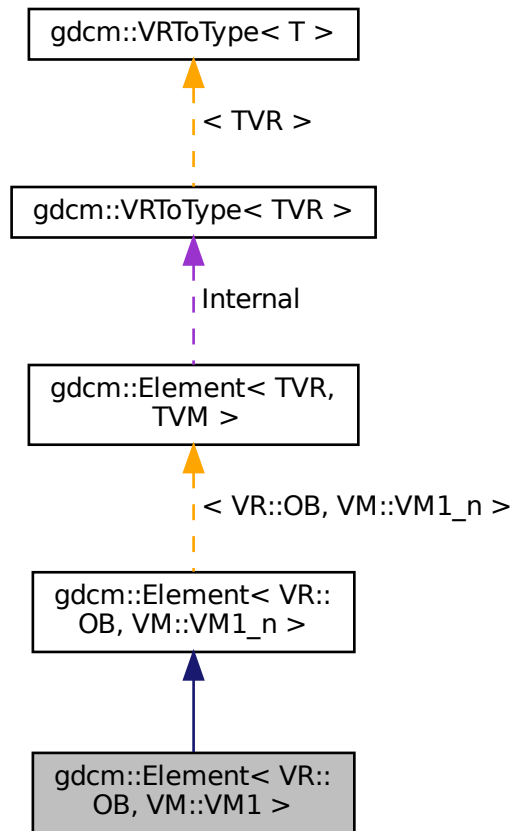

### Additional Inherited Members

The documentation for this class was generated from the following file:

- [gdcMElement.h](#)

## 10.105 `gdcM::Element< VR::OW, VM::VM1 >` Class Reference

```
#include <gdcMElement.h>
```



Inheritance diagram for gdcM::Element< VR::OW, VM::VM1 >:

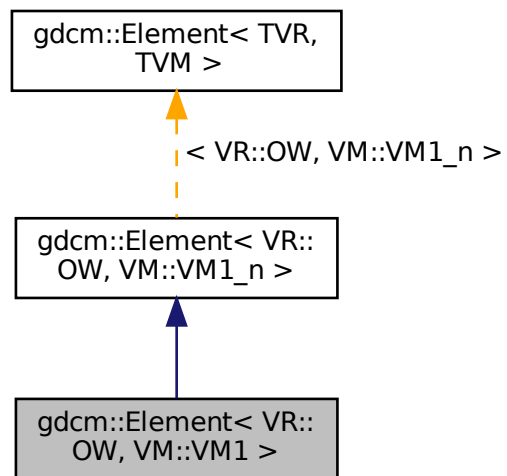

Collaboration diagram for `gdcM::Element< VR::OW, VM::VM1 >`:

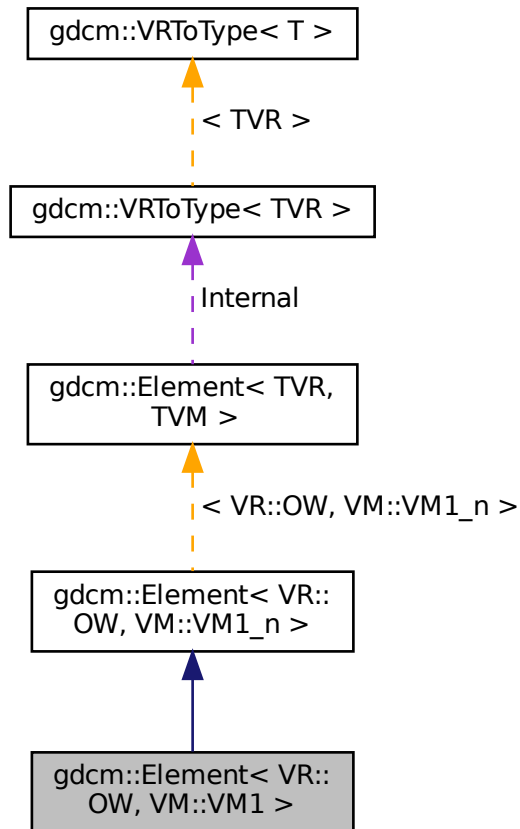

### Additional Inherited Members

The documentation for this class was generated from the following file:

- [gdcMElement.h](#)

## 10.106 `gdcM::ElementDisableCombinations< TVR, TVM >` Class Template Reference

A class which is used to produce compile errors for an invalid combination of template parameters.

```
#include <gdcMElement.h>
```

### 10.106.1 Detailed Description

```
template<long long TVR, int TVM>
class gdcm::ElementDisableCombinations< TVR, TVM >
```

A class which is used to produce compile errors for an invalid combination of template parameters.

Invalid combinations have specialized declarations with no definition.

The documentation for this class was generated from the following file:

- [gdcmElement.h](#)

## 10.107 `gdcm::ElementDisableCombinations< VR::OB, VM::VM1_n >` Class Reference

```
#include <gdcmElement.h>
```

The documentation for this class was generated from the following file:

- [gdcmElement.h](#)

## 10.108 `gdcm::ElementDisableCombinations< VR::OW, VM::VM1_n >` Class Reference

```
#include <gdcmElement.h>
```

The documentation for this class was generated from the following file:

- [gdcmElement.h](#)

## 10.109 `gdcm::EmptyMaskGenerator` Class Reference

[EmptyMaskGenerator](#) Main class to generate a Empty Mask [Series](#) from an input [Series](#). This class takes an input folder and generates a series of DICOM files in the specified output directory. This class handles multiples DICOM [Series](#) within the same input directory.

```
#include <gdcmEmptyMaskGenerator.h>
```

## Public Types

- enum [SOPClassUIDMode](#) {  
[UseOriginalSOPClassUID](#) = 0 ,  
[UseGrayscaleSecondaryImageStorage](#) }

## Public Member Functions

- [EmptyMaskGenerator](#) ()
- [~EmptyMaskGenerator](#) ()
- bool [Execute](#) ()  
*Main loop.*
- void [SetInputDirectory](#) (const char \*dirname)  
*Specify input directory.*
- void [SetOutputDirectory](#) (const char \*dirname)  
*Specify output directory.*
- void [SetSOPClassUIDMode](#) ([SOPClassUIDMode](#) mode)

### 10.109.1 Detailed Description

[EmptyMaskGenerator](#) Main class to generate a Empty Mask [Series](#) from an input [Series](#). This class takes an input folder and generates a series of DICOM files in the specified output directory. This class handles multiples DICOM [Series](#) within the same input directory.

The class allow two mode of operations:

- [UseOriginalSOPClassUID](#)
- [UseGrayscaleSecondaryImageStorage](#)

[UseOriginalSOPClassUID](#) is the mode where original attributes are copied from the original DICOM instance.

[UseGrayscaleSecondaryImageStorage](#) is the mode where attributes are generated so as to create a [MultiframeGrayscaleByteSecondaryCaptureImageStorage](#) ([MultiframeGrayscaleWordSecondaryCaptureImageStorage](#)) instance.

In both mode:

- the [Study](#) references ([StudyInstanceUID](#) and [StudyID](#)) are preserved.
- the [PatientID](#) reference is preserved.
- the [Image Type](#) attribute will be setup so that the fourth element is set to 'MASK'.
- a new [Series](#) Instance UID is generated. It is thus required to run the process over all files using the same input [Series](#) Instance UID so that a proper mapping from the old [Series](#) UID is done to the new one. Since a new [Series](#) Instance UID is generated, there is no sense to preserve the original Frame of Reference UID, although it would have made sense here.

#### Examples

[EmptyMask.cxx](#).

## 10.109.2 Member Enumeration Documentation

### 10.109.2.1 SOPClassUIDMode

```
enum gdcM::EmptyMaskGenerator::SOPClassUIDMode
```

Enumerator

UseOriginalSOPClassUID	
UseGrayscaleSecondaryImageStorage	

## 10.109.3 Constructor & Destructor Documentation

### 10.109.3.1 EmptyMaskGenerator()

```
gdcM::EmptyMaskGenerator::EmptyMaskGenerator ( )
```

### 10.109.3.2 ~EmptyMaskGenerator()

```
gdcM::EmptyMaskGenerator::~~EmptyMaskGenerator ( )
```

## 10.109.4 Member Function Documentation

### 10.109.4.1 Execute()

```
bool gdcM::EmptyMaskGenerator::Execute ( )
```

Main loop.

Examples

[EmptyMask.cxx](#).

#### 10.109.4.2 SetInputDirectory()

```
void gdcM::EmptyMaskGenerator::SetInputDirectory (
    const char * dirname )
```

Specify input directory.

##### Examples

[EmptyMask.cxx](#).

#### 10.109.4.3 SetOutputDirectory()

```
void gdcM::EmptyMaskGenerator::SetOutputDirectory (
    const char * dirname )
```

Specify output directory.

##### Examples

[EmptyMask.cxx](#).

#### 10.109.4.4 SetSOPClassUIDMode()

```
void gdcM::EmptyMaskGenerator::SetSOPClassUIDMode (
    SOPClassUIDMode mode )
```

Select generation of SOP Class UID method: Default is UseOriginalSOPClassUID

##### Examples

[EmptyMask.cxx](#).

The documentation for this class was generated from the following file:

- [gdcMEmptyMaskGenerator.h](#)

## 10.110 gdcM::EncapsulatedDocument Class Reference

[EncapsulatedDocument](#).

```
#include <gdcMEncapsulatedDocument.h>
```

## Public Member Functions

- [EncapsulatedDocument](#) ()=default

### 10.110.1 Detailed Description

[EncapsulatedDocument](#).

### 10.110.2 Constructor & Destructor Documentation

#### 10.110.2.1 EncapsulatedDocument()

```
gdcm::EncapsulatedDocument::EncapsulatedDocument ( ) [default]
```

The documentation for this class was generated from the following file:

- [gdcmEncapsulatedDocument.h](#)

## 10.111 `gdcm::EncodingImplementation< T >` Class Template Reference

[EncodingImplementation](#).

### 10.111.1 Detailed Description

```
template<long long T>  
class gdcm::EncodingImplementation< T >
```

[EncodingImplementation](#).

Note

TODO

The documentation for this class was generated from the following file:

- [gdcmElement.h](#)

## 10.112 gdcm::EncodingImplementation< VR::VRASCII > Class Reference

```
#include <gdcmElement.h>
```

### Public Member Functions

- template<> void [Write](#) (const double \*data, unsigned long length, std::ostream &\_os)

### Static Public Member Functions

- template<typename T >  
static void [Read](#) (T \*data, unsigned long length, std::istream &\_is)
- template<typename T >  
static void [ReadComputeLength](#) (T \*data, unsigned int &length, std::istream &\_is)
- template<typename T >  
static void [ReadNoSwap](#) (T \*data, unsigned long length, std::istream &\_is)
- template<typename T >  
static void [Write](#) (const T \*data, unsigned long length, std::ostream &\_os)

### 10.112.1 Member Function Documentation

#### 10.112.1.1 Read()

```
template<typename T >
static void gdcm::EncodingImplementation< VR::VRASCII >::Read (
    T * data,
    unsigned long length,
    std::istream & _is ) [inline], [static]
```

#### 10.112.1.2 ReadComputeLength()

```
template<typename T >
static void gdcm::EncodingImplementation< VR::VRASCII >::ReadComputeLength (
    T * data,
    unsigned int & length,
    std::istream & _is ) [inline], [static]
```

References [gdcm::backslash\(\)](#).



### 10.112.1.3 ReadNoSwap()

```
template<typename T >
static void gdcm::EncodingImplementation< VR::VRASCII >::ReadNoSwap (
    T * data,
    unsigned long length,
    std::istream & _is ) [inline], [static]
```

### 10.112.1.4 Write() [1/2]

```
template<>
void gdcm::EncodingImplementation< VR::VRASCII >::Write (
    const double * data,
    unsigned long length,
    std::ostream & _os ) [inline]
```

References `gdcm::x16printf()`.

### 10.112.1.5 Write() [2/2]

```
template<typename T >
static void gdcm::EncodingImplementation< VR::VRASCII >::Write (
    const T * data,
    unsigned long length,
    std::ostream & _os ) [inline], [static]
```

The documentation for this class was generated from the following file:

- [gdcmElement.h](#)

## 10.113 gdcm::EncodingImplementation< VR::VRBINARY > Class Reference

```
#include <gdcmElement.h>
```

### Static Public Member Functions

- `template<typename T >`  
static void `Read` (T \*data, unsigned long length, std::istream &\_is)
- `template<typename T >`  
static void `ReadComputeLength` (T \*data, unsigned int &length, std::istream &\_is)
- `template<typename T >`  
static void `ReadNoSwap` (T \*data, unsigned long length, std::istream &\_is)
- `template<typename T >`  
static void `Write` (const T \*data, unsigned long length, std::ostream &\_os)

## 10.113.1 Member Function Documentation

### 10.113.1.1 Read()

```
template<typename T >
static void gdcm::EncodingImplementation< VR::VRBINARY >::Read (
    T * data,
    unsigned long length,
    std::istream & _is ) [inline], [static]
```

### 10.113.1.2 ReadComputeLength()

```
template<typename T >
static void gdcm::EncodingImplementation< VR::VRBINARY >::ReadComputeLength (
    T * data,
    unsigned int & length,
    std::istream & _is ) [inline], [static]
```

### 10.113.1.3 ReadNoSwap()

```
template<typename T >
static void gdcm::EncodingImplementation< VR::VRBINARY >::ReadNoSwap (
    T * data,
    unsigned long length,
    std::istream & _is ) [inline], [static]
```

### 10.113.1.4 Write()

```
template<typename T >
static void gdcm::EncodingImplementation< VR::VRBINARY >::Write (
    const T * data,
    unsigned long length,
    std::ostream & _os ) [inline], [static]
```

The documentation for this class was generated from the following file:

- [gdcmElement.h](#)

## 10.114 gdcM::EndEvent Class Reference

```
#include <gdcMEvent.h>
```

Inheritance diagram for gdcM::EndEvent:

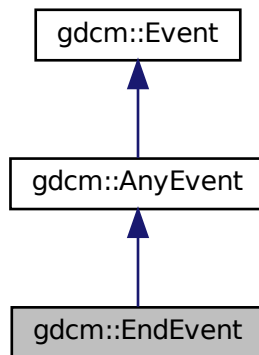

Collaboration diagram for gdcM::EndEvent:

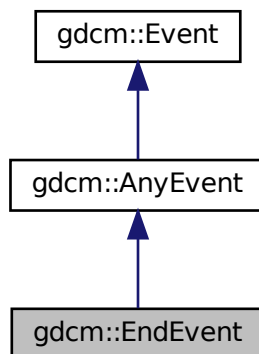

### Additional Inherited Members

The documentation for this class was generated from the following file:

- [gdcMEvent.h](#)

## 10.115 gdcM::EnumeratedValues Class Reference

**Element.** A Data [Element](#) with Enumerated Values that does not have a [Value](#) equivalent to one of the Values specified in this standard has an invalid value within the scope of a specific Information Object/SOP Class definition. Note:

```
#include <gdcMEnumeratedValues.h>
```

### Public Member Functions

- [EnumeratedValues](#) ()=default

#### 10.115.1 Detailed Description

**Element.** A Data [Element](#) with Enumerated Values that does not have a [Value](#) equivalent to one of the Values specified in this standard has an invalid value within the scope of a specific Information Object/SOP Class definition. Note:

1. [Patient](#) Sex (0010, 0040) is an example of a Data [Element](#) having Enumerated Values. It is defined to have a [Value](#) that is either "M", "F", or "O" (see PS 3.3). No other [Value](#) shall be given to this Data [Element](#).
2. Future modifications of this standard may add to the set of allowed values for Data Elements with Enumerated Values. Such additions by themselves may or may not require a change in SOP Class [UIDs](#), depending on the semantics of the Data [Element](#).

#### 10.115.2 Constructor & Destructor Documentation

##### 10.115.2.1 EnumeratedValues()

```
gdcM::EnumeratedValues::EnumeratedValues ( ) [default]
```

The documentation for this class was generated from the following file:

- [gdcMEnumeratedValues.h](#)

## 10.116 gdcM::EquipmentManufacturer Class Reference

```
#include <gdcMEquipmentManufacturer.h>
```

## Public Types

- enum `Type` {  
    `UNKNOWN` = 0 ,  
    `FUJI` ,  
    `GEMS` ,  
    `HITACHI` ,  
    `KODAK` ,  
    `MARCONI` ,  
    `PMS` ,  
    `SIEMENS` ,  
    `TOSHIBA` }

## Static Public Member Functions

- static `Type` `Compute` (`DataSet` const &ds)

### 10.116.1 Detailed Description

### 10.116.2 Member Enumeration Documentation

#### 10.116.2.1 Type

enum `gdcM::EquipmentManufacturer::Type`

##### Enumerator

UNKNOWN	
FUJI	
GEMS	
HITACHI	
KODAK	
MARCONI	
PMS	
SIEMENS	
TOSHIBA	

### 10.116.3 Member Function Documentation

#### 10.116.3.1 Compute()

```
static Type gdcM::EquipmentManufacturer::Compute (  
    DataSet const & ds ) [static]
```

The documentation for this class was generated from the following file:

- [gdcMEquipmentManufacturer.h](#)

### 10.117 gdcM::Event Class Reference

superclass for callback/observer methods

```
#include <gdcMEvent.h>
```

Inheritance diagram for gdcM::Event:

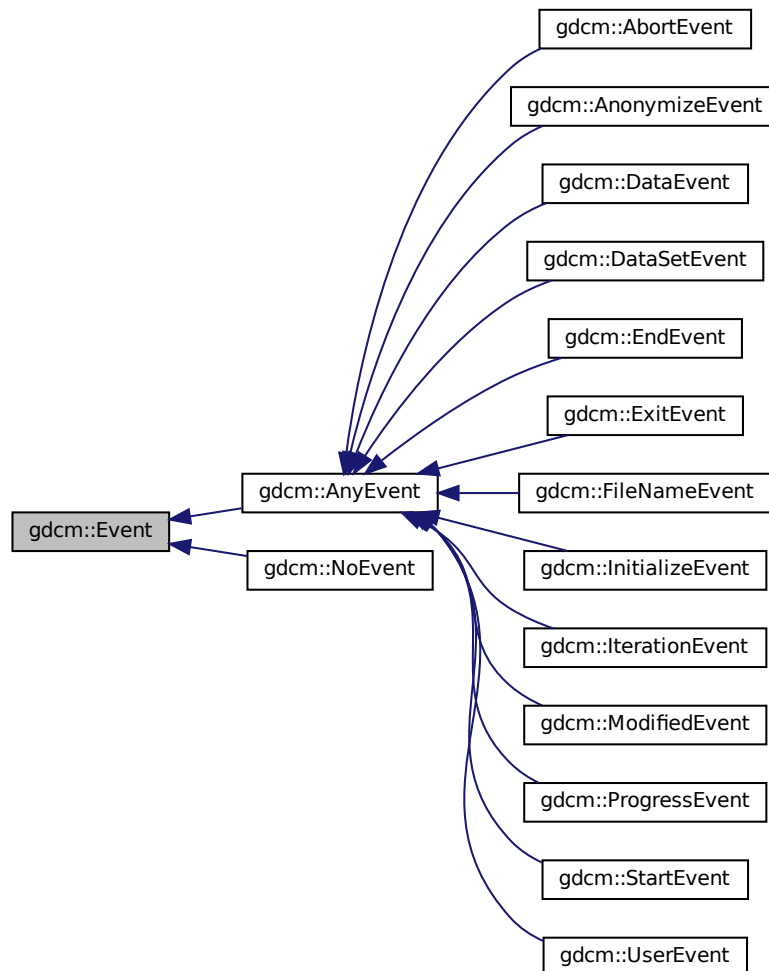

## Public Member Functions

- [Event](#) ()
- [Event](#) (const [Event](#) &)
- virtual [~Event](#) ()
- virtual bool [CheckEvent](#) (const [Event](#) \*) const =0
- virtual const char \* [GetEventName](#) () const =0
- virtual [Event](#) \* [MakeObject](#) () const =0
- void [operator=](#) (const [Event](#) &)=delete
- virtual void [Print](#) (std::ostream &os) const

### 10.117.1 Detailed Description

superclass for callback/observer methods

See also

[Command Subject](#)

Examples

[SimpleScanner.cxx](#).

### 10.117.2 Constructor & Destructor Documentation

#### 10.117.2.1 Event() [1/2]

```
gdcM::Event::Event ( )
```

#### 10.117.2.2 ~Event()

```
virtual gdcM::Event::~~Event ( ) [virtual]
```

#### 10.117.2.3 Event() [2/2]

```
gdcM::Event::Event (
    const Event & )
```

### 10.117.3 Member Function Documentation

#### 10.117.3.1 CheckEvent()

```
virtual bool gdcM::Event::CheckEvent (
    const Event * ) const [pure virtual]
```

Check if given event matches or derives from this event.



### 10.117.3.2 GetEventName()

```
virtual const char* gdcM::Event::GetEventName ( ) const [pure virtual]
```

Return the `StringName` associated with the event.

Implemented in [gdcM::AnonymizeEvent](#), [gdcM::DataSetEvent](#), [gdcM::ProgressEvent](#), [gdcM::FileNameEvent](#), and [gdcM::DataEvent](#).

### 10.117.3.3 MakeObject()

```
virtual Event* gdcM::Event::MakeObject ( ) const [pure virtual]
```

Create an `Event` of this type This method work as a Factory for creating events of each particular type.

Implemented in [gdcM::AnonymizeEvent](#), [gdcM::DataSetEvent](#), [gdcM::ProgressEvent](#), [gdcM::FileNameEvent](#), and [gdcM::DataEvent](#).

### 10.117.3.4 operator=()

```
void gdcM::Event::operator= (
    const Event & ) [delete]
```

### 10.117.3.5 Print()

```
virtual void gdcM::Event::Print (
    std::ostream & os ) const [virtual]
```

Print `Event` information. This method can be overridden by specific `Event` subtypes. The default is to print out the type of the event.

Referenced by `gdcM::operator<<()`.

The documentation for this class was generated from the following file:

- [gdcMEvent.h](#)

## 10.118 gdcm::Exception Class Reference

Exception.

```
#include <gdcmException.h>
```

Inheritance diagram for gdcm::Exception:

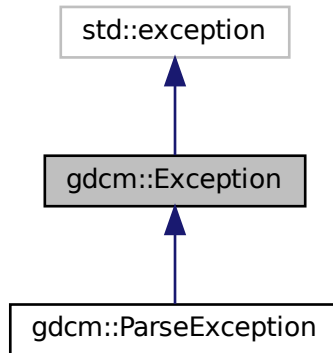

Collaboration diagram for gdcm::Exception:

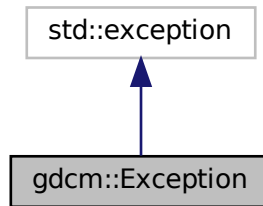

### Public Member Functions

- [Exception](#) (const char \*desc="None", const char \*file=\_\_FILE\_\_, unsigned int lineNumber=\_\_LINE\_\_, const char \*func="")
- [~Exception](#) () override throw ()
- const char \* [GetDescription](#) () const  
*Return the Description.*
- const char \* [what](#) () const override throw ()  
*what implementation*

## 10.118.1 Detailed Description

Exception.

Standard exception handling object.

Note

Its copy-constructor and assignment operator are generated by the compiler.

## 10.118.2 Constructor & Destructor Documentation

### 10.118.2.1 Exception()

```
gdcmm::Exception::Exception (
    const char * desc = "None",
    const char * file = __FILE__,
    unsigned int lineNumber = __LINE__,
    const char * func = "" ) [inline], [explicit]
```

Explicit constructor, initializing the description and the text returned by [what\(\)](#).

Note

The last parameter is ignored for the time being. It may be used to specify the function where the exception was thrown.

### 10.118.2.2 ~Exception()

```
gdcmm::Exception::~Exception ( ) throw ( ) [inline], [override]
```

## 10.118.3 Member Function Documentation

### 10.118.3.1 GetDescription()

```
const char* gdcmm::Exception::GetDescription ( ) const [inline]
```

Return the Description.

Referenced by [gdcmm::SequenceOfItems::Read\(\)](#).

### 10.118.3.2 what()

```
const char* gdcM::Exception::what ( ) const throw ( ) [inline], [override]
```

what implementation

Referenced by gdcM::SequenceOfFragments::ReadValue().

The documentation for this class was generated from the following file:

- [gdcMException.h](#)

## 10.119 gdcM::ExitEvent Class Reference

```
#include <gdcMEvent.h>
```

Inheritance diagram for gdcM::ExitEvent:

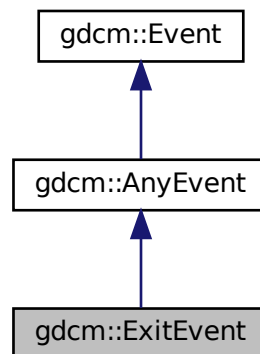

Collaboration diagram for gdcm::ExitEvent:

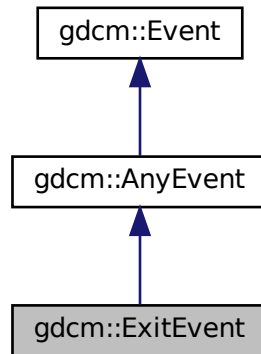

### Additional Inherited Members

The documentation for this class was generated from the following file:

- [gdcmEvent.h](#)

## 10.120 gdcm::ExplicitDataElement Class Reference

Class to read/write a [DataElement](#) as Explicit Data [Element](#).

```
#include <gdcmExplicitDataElement.h>
```

Inheritance diagram for gdcm::ExplicitDataElement:

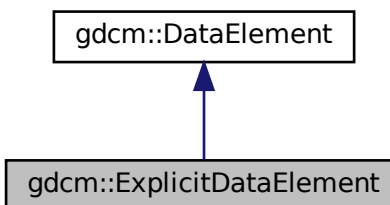

Collaboration diagram for `gdcM::ExplicitDataElement`:

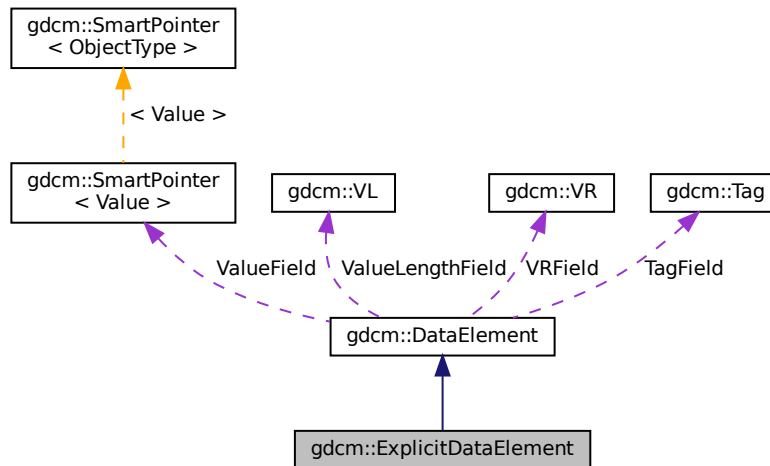

## Public Member Functions

- [VL GetLength](#) () const
- template<typename TSwap >  
std::istream & [Read](#) (std::istream &is)
- template<typename TSwap >  
std::istream & [ReadPreValue](#) (std::istream &is)
- template<typename TSwap >  
std::istream & [ReadValue](#) (std::istream &is, bool readvalues=true)
- template<typename TSwap >  
std::istream & [ReadWithLength](#) (std::istream &is, VL &length)
- template<typename TSwap >  
const std::ostream & [Write](#) (std::ostream &os) const

## Additional Inherited Members

### 10.120.1 Detailed Description

Class to read/write a [DataElement](#) as Explicit Data [Element](#).

#### Note

bla

#### Examples

[DumpSiemensBase64.cxx](#), [DumpToshibaDTI.cxx](#), [DumpToshibaDTI2.cxx](#), and [ReadAndDumpDICOMDIR2.cxx](#).

## 10.120.2 Member Function Documentation

### 10.120.2.1 GetLength()

```
VL gdcm::ExplicitDataElement::GetLength ( ) const
```

### 10.120.2.2 Read()

```
template<typename TSwap >  
std::istream& gdcm::ExplicitDataElement::Read (  
    std::istream & is )
```

### 10.120.2.3 ReadPreValue()

```
template<typename TSwap >  
std::istream& gdcm::ExplicitDataElement::ReadPreValue (  
    std::istream & is )
```

### 10.120.2.4 ReadValue()

```
template<typename TSwap >  
std::istream& gdcm::ExplicitDataElement::ReadValue (  
    std::istream & is,  
    bool readvalues = true )
```

### 10.120.2.5 ReadWithLength()

```
template<typename TSwap >  
std::istream& gdcm::ExplicitDataElement::ReadWithLength (  
    std::istream & is,  
    VL & length )
```

### 10.120.2.6 Write()

```
template<typename TSwap >  
const std::ostream& gdcm::ExplicitDataElement::Write (  
    std::ostream & os ) const
```

The documentation for this class was generated from the following file:

- [gdcmExplicitDataElement.h](#)

## 10.121 gdcm::ExplicitImplicitDataElement Class Reference

Class to read/write a [DataElement](#) as ExplicitImplicit Data [Element](#).

```
#include <gdcmExplicitImplicitDataElement.h>
```

Inheritance diagram for gdcm::ExplicitImplicitDataElement:

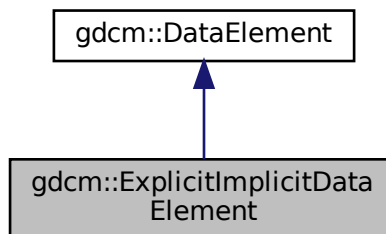



Collaboration diagram for gdcM::ExplicitImplicitDataElement:

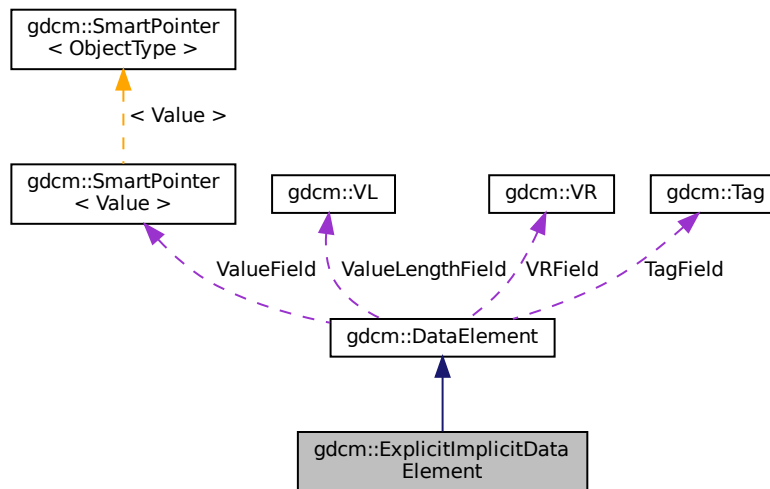

## Public Member Functions

- [VL GetLength](#) () const
- template<typename TSwap >  
std::istream & [Read](#) (std::istream &is)
- template<typename TSwap >  
std::istream & [ReadPreValue](#) (std::istream &is)
- template<typename TSwap >  
std::istream & [ReadValue](#) (std::istream &is, bool readvalues=true)
- template<typename TSwap >  
std::istream & [ReadWithLength](#) (std::istream &is, [VL](#) &length)

## Additional Inherited Members

### 10.121.1 Detailed Description

Class to read/write a [DataElement](#) as ExplicitImplicit Data [Element](#).

#### Note

This only happen for some Philips images Should I derive from [ExplicitDataElement](#) instead ? This is the class that is the closest the GDCM1.x parser. At each element we try first to read it as explicit, if this fails, then we try again as an implicit element.

## 10.121.2 Member Function Documentation

### 10.121.2.1 GetLength()

```
VL gdcM::ExplicitImplicitDataElement::GetLength ( ) const
```

### 10.121.2.2 Read()

```
template<typename TSwap >  
std::istream& gdcM::ExplicitImplicitDataElement::Read (  
    std::istream & is )
```

### 10.121.2.3 ReadPreValue()

```
template<typename TSwap >  
std::istream& gdcM::ExplicitImplicitDataElement::ReadPreValue (  
    std::istream & is )
```

### 10.121.2.4 ReadValue()

```
template<typename TSwap >  
std::istream& gdcM::ExplicitImplicitDataElement::ReadValue (  
    std::istream & is,  
    bool readvalues = true )
```

### 10.121.2.5 ReadWithLength()

```
template<typename TSwap >  
std::istream& gdcM::ExplicitImplicitDataElement::ReadWithLength (  
    std::istream & is,  
    VL & length ) [inline]
```

The documentation for this class was generated from the following file:

- [gdcMExplicitImplicitDataElement.h](#)

## 10.122 gdcm::Fiducials Class Reference

[Fiducials](#).

```
#include <gdcmFiducials.h>
```

### Public Member Functions

- [Fiducials](#) ()=default

#### 10.122.1 Detailed Description

[Fiducials](#).

#### 10.122.2 Constructor & Destructor Documentation

##### 10.122.2.1 Fiducials()

```
gdcm::Fiducials::Fiducials ( ) [default]
```

The documentation for this class was generated from the following file:

- [gdcmFiducials.h](#)

## 10.123 gdcm::File Class Reference

a DICOM [File](#)

```
#include <gdcmFile.h>
```

Inheritance diagram for `gdcM::File`:

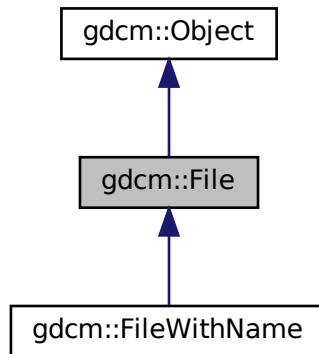

Collaboration diagram for `gdcM::File`:

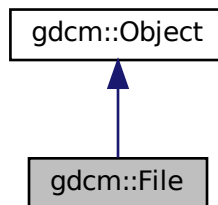

## Public Member Functions

- [File](#) ()
- [~File](#) () override
- [DataSet](#) & [GetDataSet](#) ()  
*Get Data Set.*
- const [DataSet](#) & [GetDataSet](#) () const  
*Get Data Set.*
- [FileMetaInformation](#) & [GetHeader](#) ()  
*Get File Meta Information.*
- const [FileMetaInformation](#) & [GetHeader](#) () const  
*Get File Meta Information.*

- `std::istream & Read (std::istream &is)`  
*Read.*
- `void SetDataSet (const DataSet &ds)`  
*Set Data Set.*
- `void SetHeader (const FileMetaInformation &fmi)`  
*Set File Meta Information.*
- `std::ostream const & Write (std::ostream &os) const`  
*Write.*

## Friends

- `std::ostream & operator<< (std::ostream &os, const File &val)`

## Additional Inherited Members

### 10.123.1 Detailed Description

a DICOM [File](#)

See PS 3.10 [File](#): A [File](#) is an ordered string of zero or more bytes, where the first byte is at the beginning of the file and the last byte at the end of the [File](#). Files are identified by a unique [File](#) ID and may be written, read and/or deleted.

See also

[Reader Writer](#)

Examples

[ChangePrivateTags.cxx](#), [ChangeSequenceUltrasound.cxx](#), [CreateFakeRTDOSE.cxx](#), [CreateJPIPDataSet.cxx](#), [DeriveSeries.cxx](#), [DiffFile.cxx](#), [DumpGEMSMovieGroup.cxx](#), [DumpPhilipsECHO.cxx](#), [DumpSiemensBase64.cxx](#), [DumpToshibaDTI.cxx](#), [DumpToshibaDTI2.cxx](#), [DumpVisusChange.cxx](#), [DuplicatePCDE.cxx](#), [EncapsulateFileInRawData.cxx](#), [ExtractEncryptedContent.cxx](#), [Extracting\\_All\\_Resolution.cxx](#), [Fake\\_Image\\_Using\\_Stream\\_Image\\_Writer.cxx](#), [FixBrokenJ2K.cxx](#), [FixOrientation.cxx](#), [GenAllIVR.cxx](#), [GenFakeIdentifyFile.cxx](#), [GenFakeImage.cxx](#), [GenLongSeqs.cxx](#), [GenSeqs.cxx](#), [GetJPEGSamplePrecision.cxx](#), [GetSequenceUltrasound.cxx](#), [GetSubSequenceData.cxx](#), [HelloWorld.cxx](#), [LargeVRDSExplicit.cxx](#), [MakeTemplate.cxx](#), [PatchFile.cxx](#), [QIDO-RS.cxx](#), [ReadAndDumpDICOMDIR.cxx](#), [ReadAndPrintAttributes.cxx](#), [StreamImageReaderTest.cxx](#), [TemplateEmptyImage.cxx](#), and [iU22tomultisc.cxx](#).

### 10.123.2 Constructor & Destructor Documentation

#### 10.123.2.1 File()

```
gdcm::File::File ( )
```

### 10.123.2.2 ~File()

```
gdcM::File::~~File ( ) [override]
```

## 10.123.3 Member Function Documentation

### 10.123.3.1 GetDataSet() [1/2]

```
DataSet& gdcM::File::GetDataSet ( ) [inline]
```

Get Data Set.

### 10.123.3.2 GetDataSet() [2/2]

```
const DataSet& gdcM::File::GetDataSet ( ) const [inline]
```

Get Data Set.

#### Examples

[ChangePrivateTags.cxx](#), [ChangeSequenceUltrasound.cxx](#), [CreateFakeRTDOSE.cxx](#), [CreateJPIPDataSet.cxx](#), [DeriveSeries.cxx](#), [DiffFile.cxx](#), [DumpADAC.cxx](#), [DumpExamCard.cxx](#), [DumpGEMSMovieGroup.cxx](#), [DumpImageHeaderInfo.cxx](#), [DumpPhilipsECHO.cxx](#), [DumpSiemensBase64.cxx](#), [DumpToshibaDTI.cxx](#), [DumpToshibaDTI2.cxx](#), [DumpVisusChange.cxx](#), [DuplicatePCDE.cxx](#), [ELSCINT1WaveToText.cxx](#), [ExtractEncryptedContent.cxx](#), [Extracting\\_All\\_Resolution.cxx](#), [Fake\\_Image\\_Using\\_Stream\\_Image\\_Writer.cxx](#), [FixBrokenJ2K.cxx](#), [FixJAIBugJPEGLS.cxx](#), [FixOrientation.cxx](#), [GenAllVR.cxx](#), [GenFakeIdentifyFile.cxx](#), [GenLongSeqs.cxx](#), [GenSeqs.cxx](#), [GetJPEGSamplePrecision.cxx](#), [GetSequenceUltrasound.cxx](#), [GetSubSequenceData.cxx](#), [HelloWorld.cxx](#), [LargeVRDSExplicit.cxx](#), [MergeTwoFiles.cxx](#), [MrProtocol.cxx](#), [PatchFile.cxx](#), [QIDO-RS.cxx](#), [ReadAndDumpDICOMDIR.cxx](#), [ReadAndDumpDICOMDIR2.cxx](#), [ReadAndPrintAttributes.cxx](#), [ReadExplicitLengthSQIVR.cxx](#), [StreamImageReaderTest.cxx](#), [TemplateEmptyImage.cxx](#), [csa2img.cxx](#), [gdcMrtionplan.cxx](#), [gdcMrtplan.cxx](#), [iU22tomultisc.cxx](#), [pmsct\\_rgb1.cxx](#), and [rle2img.cxx](#).

### 10.123.3.3 GetHeader() [1/2]

```
FileMetaInformation& gdcM::File::GetHeader ( ) [inline]
```

Get [File](#) Meta Information.

### 10.123.3.4 GetHeader() [2/2]

```
const FileMetaInformation& gdcM::File::GetHeader ( ) const [inline]
```

Get [File](#) Meta Information.

#### Examples

[CreateJPIPDataSet.cxx](#), [DumpToshibaDTI.cxx](#), [DumpToshibaDTI2.cxx](#), [EncapsulateFileInRawData.cxx](#), [Extracting\\_All\\_Resolution.cxx](#), [Fake\\_Image\\_Using\\_Stream\\_Image\\_Writer.cxx](#), [FixJAIBugJPEGLS.cxx](#), [GenAllVR.cxx](#), [GenFakeIdentifyFile.cxx](#), [GetJPEGSamplePrecision.cxx](#), [LargeVRDSExplicit.cxx](#), [MakeTemplate.cxx](#), [MergeTwoFiles.cxx](#), [MpegVideoInfo.cs](#), [QIDO-RS.cxx](#), [ReadAndDumpDICOMDIR.cxx](#), [StreamImageReaderTest.cxx](#), [pmsct\\_rgb1.cxx](#), and [rle2img.cxx](#).

### 10.123.3.5 Read()

```
std::istream& gdcM::File::Read (
    std::istream & is )
```

Read.

### 10.123.3.6 SetDataSet()

```
void gdcM::File::SetDataSet (
    const DataSet & ds ) [inline]
```

Set Data Set.

### 10.123.3.7 SetHeader()

```
void gdcM::File::SetHeader (
    const FileMetaInformation & fmi ) [inline]
```

Set [File](#) Meta Information.

### 10.123.3.8 Write()

```
std::ostream const& gdcM::File::Write (
    std::ostream & os ) const
```

Write.

## 10.123.4 Friends And Related Function Documentation

### 10.123.4.1 operator<<

```
std::ostream& operator<< (
    std::ostream & os,
    const File & val ) [friend]
```

The documentation for this class was generated from the following file:

- [gdcMFile.h](#)

## 10.124 gdcM::FileAnonymizer Class Reference

[FileAnonymizer](#).

```
#include <gdcMFileAnonymizer.h>
```

Inheritance diagram for gdcM::FileAnonymizer:

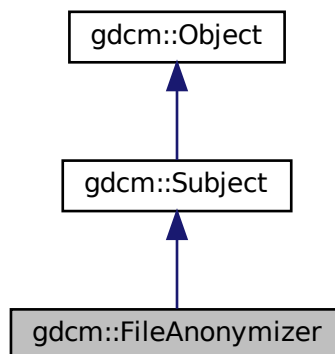



Collaboration diagram for gdcm::FileAnonymizer:

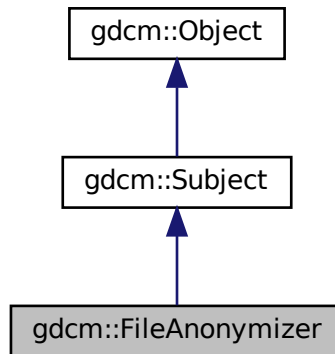

## Public Member Functions

- [FileAnonymizer](#) ()
- [~FileAnonymizer](#) () override
- void [Empty](#) (Tag const &t)
- void [Remove](#) (Tag const &t)  
*remove a tag (even a SQ can be removed)*
- void [Replace](#) (Tag const &t, const char \*value\_data, VL const &vl)
- void [Replace](#) (Tag const &t, const char \*value\_str)
- void [SetInputFileName](#) (const char \*filename\_native)  
*Set input filename.*
- void [SetOutputFileName](#) (const char \*filename\_native)  
*Set output filename.*
- bool [Write](#) ()  
*Write the output file.*

## Additional Inherited Members

### 10.124.1 Detailed Description

[FileAnonymizer](#).

This [Anonymizer](#) is a file-based [Anonymizer](#). It requires a valid DICOM file and will use the [Value](#) Length to skip over any information.

It will not load the DICOM dataset taken from [SetInputFileName\(\)](#) into memory and should consume much less memory than [Anonymizer](#).

**Warning**

: Each time you call [Replace\(\)](#) with a value. This value will copied, and stored in memory. The behavior is not ideal for extremely large data (larger than memory size). This class is really meant to take a large DICOM input file and then only changed some small attribute.

**caveats:**

- This class will NOT work with unordered attributes in a DICOM [File](#),
- This class does neither recompute nor update the Group Length element,
- This class currently does not update the [File](#) Meta Information header.
- Only strict inplace Replace operation is supported when input and output file are the same.

**Examples**

[MakeTemplate.cxx](#).

**10.124.2 Constructor & Destructor Documentation****10.124.2.1 FileAnonymizer()**

```
gdcm::FileAnonymizer::FileAnonymizer ( )
```

**10.124.2.2 ~FileAnonymizer()**

```
gdcm::FileAnonymizer::~~FileAnonymizer ( ) [override]
```

**10.124.3 Member Function Documentation****10.124.3.1 Empty()**

```
void gdcm::FileAnonymizer::Empty (
    Tag const & t )
```

Make [Tag](#) t empty Warning: does not handle SQ element

**Examples**

[MakeTemplate.cxx](#).

### 10.124.3.2 Remove()

```
void gdcmm::FileAnonymizer::Remove (
    Tag const & t )
```

remove a tag (even a SQ can be removed)

### 10.124.3.3 Replace() [1/2]

```
void gdcmm::FileAnonymizer::Replace (
    Tag const & t,
    const char * value_data,
    VL const & vl )
```

when the value contains \0, it is a good idea to specify the length. This function is required when dealing with VRBINARY tag

### 10.124.3.4 Replace() [2/2]

```
void gdcmm::FileAnonymizer::Replace (
    Tag const & t,
    const char * value_str )
```

Replace tag with another value, if tag is not found it will be created: WARNING: this function can only execute if tag is a VRASCII WARNING: Do not ever try to write a value in a SQ Data [Element](#) !

### 10.124.3.5 SetInputFileName()

```
void gdcmm::FileAnonymizer::SetInputFileName (
    const char * filename_native )
```

Set input filename.

#### Examples

[FileAnonymize.cs](#), and [MakeTemplate.cxx](#).

### 10.124.3.6 SetOutputFileName()

```
void gdcM::FileAnonymizer::SetOutputFileName (
    const char * filename_native )
```

Set output filename.

#### Examples

[MakeTemplate.cxx](#).

### 10.124.3.7 Write()

```
bool gdcM::FileAnonymizer::Write ( )
```

Write the output file.

#### Examples

[MakeTemplate.cxx](#).

The documentation for this class was generated from the following file:

- [gdcMFileAnonymizer.h](#)

## 10.125 gdcM::FileChangeTransferSyntax Class Reference

[FileChangeTransferSyntax](#).

```
#include <gdcMFileChangeTransferSyntax.h>
```

Inheritance diagram for gdcM::FileChangeTransferSyntax:

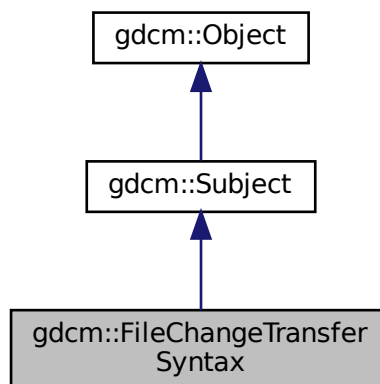

Collaboration diagram for gdcm::FileChangeTransferSyntax:

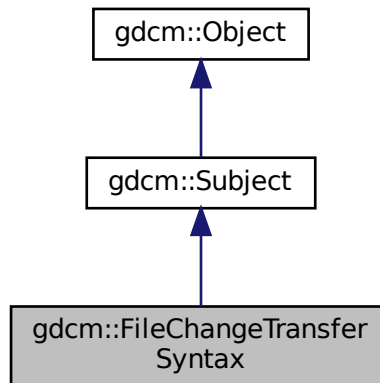

## Public Member Functions

- [FileChangeTransferSyntax](#) ()
- [~FileChangeTransferSyntax](#) () override
- bool [Change](#) ()  
*Change the transfer syntax.*
- [ImageCodec](#) \* [GetCodec](#) ()
- void [SetInputFileName](#) (const char \*filename\_native)  
*Set input filename (raw DICOM)*
- void [SetOutputFileName](#) (const char \*filename\_native)  
*Set output filename (target compressed DICOM)*
- void [SetTransferSyntax](#) ([TransferSyntax](#) const &ts)  
*Specify the Target Transfer Syntax.*

## Static Public Member Functions

- static [SmartPointer](#)< [FileChangeTransferSyntax](#) > [New](#) ()  
*for wrapped language: instantiate a reference counted object*

## Additional Inherited Members

### 10.125.1 Detailed Description

[FileChangeTransferSyntax](#).

This class is a file-based (limited) replacement of the in-memory [ImageChangeTransferSyntax](#).

This class provide a file-based compression-only mechanism. It will take in an uncompressed DICOM image file (Pixel Data element). Then produced as output a compressed DICOM file (Transfer Syntax will be updated).

Currently it supports the following transfer syntax:

- JPEGLosslessProcess14\_1

## 10.125.2 Constructor & Destructor Documentation

### 10.125.2.1 FileChangeTransferSyntax()

```
gdcm::FileChangeTransferSyntax::FileChangeTransferSyntax ( )
```

### 10.125.2.2 ~FileChangeTransferSyntax()

```
gdcm::FileChangeTransferSyntax::~~FileChangeTransferSyntax ( ) [override]
```

## 10.125.3 Member Function Documentation

### 10.125.3.1 Change()

```
bool gdcm::FileChangeTransferSyntax::Change ( )
```

Change the transfer syntax.

### 10.125.3.2 GetCodec()

```
ImageCodec\* gdcm::FileChangeTransferSyntax::GetCodec ( )
```

Retrieve the actual codec (valid after calling SetTransferSyntax) Only advanced users should call this function.

### 10.125.3.3 New()

```
static SmartPointer<FileChangeTransferSyntax> gdcm::FileChangeTransferSyntax::New ( ) [inline],  
[static]
```

for wrapped language: instantiate a reference counted object

### 10.125.3.4 SetInputFileName()

```
void gdcm::FileChangeTransferSyntax::SetInputFileName (  
    const char * filename_native )
```

Set input filename (raw DICOM)

### 10.125.3.5 SetOutputFileName()

```
void gdcm::FileChangeTransferSyntax::SetOutputFileName (  
    const char * filename_native )
```

Set output filename (target compressed DICOM)

### 10.125.3.6 SetTransferSyntax()

```
void gdcm::FileChangeTransferSyntax::SetTransferSyntax (  
    TransferSyntax const & ts )
```

Specify the Target Transfer Syntax.

The documentation for this class was generated from the following file:

- [gdcmFileChangeTransferSyntax.h](#)

## 10.126 gdcm::FileDecompressLookupTable Class Reference

[FileDecompressLookupTable](#) class.

```
#include <gdcmFileDecompressLookupTable.h>
```

Inheritance diagram for `gdcm::FileDecompressLookupTable`:

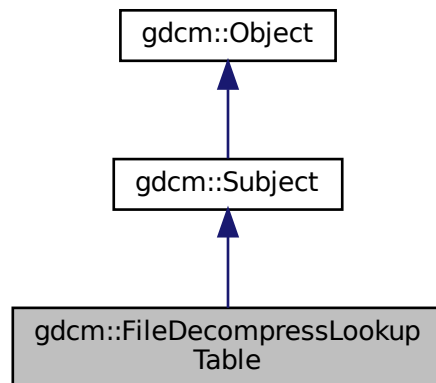

Collaboration diagram for `gdcm::FileDecompressLookupTable`:

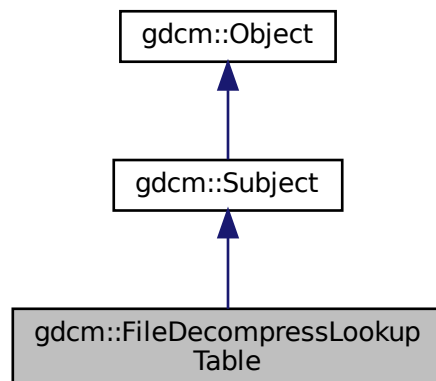



## Public Member Functions

- [FileDecompressLookupTable](#) ()=default
- [~FileDecompressLookupTable](#) () override=default
- bool [Change](#) ()  
*Decompress.*
- [File](#) & [GetFile](#) ()
- [Pixmap](#) & [GetPixmap](#) ()
- const [Pixmap](#) & [GetPixmap](#) () const
- void [SetFile](#) (const [File](#) &f)  
*Set/Get File.*
- void [SetPixmap](#) ([Pixmap](#) const &img)

## Additional Inherited Members

### 10.126.1 Detailed Description

[FileDecompressLookupTable](#) class.

It decompress the segmented LUT into linearized one (only PALETTE\_COLOR images) Output will be a [PhotometricInterpretation](#)=RGB image

### 10.126.2 Constructor & Destructor Documentation

#### 10.126.2.1 FileDecompressLookupTable()

```
gdcm::FileDecompressLookupTable::FileDecompressLookupTable ( ) [default]
```

#### 10.126.2.2 ~FileDecompressLookupTable()

```
gdcm::FileDecompressLookupTable::~~FileDecompressLookupTable ( ) [override], [default]
```

### 10.126.3 Member Function Documentation

### 10.126.3.1 Change()

```
bool gdcM::FileDecompressLookupTable::Change ( )
```

Decompress.

### 10.126.3.2 GetFile()

```
File& gdcM::FileDecompressLookupTable::GetFile ( ) [inline]
```

### 10.126.3.3 GetPixmap() [1/2]

```
Pixmap& gdcM::FileDecompressLookupTable::GetPixmap ( ) [inline]
```

### 10.126.3.4 GetPixmap() [2/2]

```
const Pixmap& gdcM::FileDecompressLookupTable::GetPixmap ( ) const [inline]
```

### 10.126.3.5 SetFile()

```
void gdcM::FileDecompressLookupTable::SetFile (
    const File & f ) [inline]
```

Set/Get [File](#).

### 10.126.3.6 SetPixmap()

```
void gdcM::FileDecompressLookupTable::SetPixmap (
    Pixmap const & img ) [inline]
```

The documentation for this class was generated from the following file:

- [gdcMFileDecompressLookupTable.h](#)

## 10.127 gdcm::FileDerivation Class Reference

[FileDerivation](#) class.

```
#include <gdcmFileDerivation.h>
```

### Public Member Functions

- [FileDerivation](#) ()
- [~FileDerivation](#) ()
- bool [AddReference](#) (const char \*referencedsopclassuid, const char \*referencedsopinstanceuid)
- bool [Derive](#) ()
  - Change.*
- [File](#) & [GetFile](#) ()
- const [File](#) & [GetFile](#) () const
- void [SetAppendDerivationHistory](#) (bool b)
- void [SetDerivationCodeSequenceCodeValue](#) (unsigned int codevalue)
  - Specify the Derivation Code Sequence Code Value. Eg 113040.*
- void [SetDerivationDescription](#) (const char \*dd)
  - Specify the Derivation Description. Eg "lossy conversion".*
- void [SetFile](#) (const [File](#) &f)
  - Set/Get File.*
- void [SetPurposeOfReferenceCodeSequenceCodeValue](#) (unsigned int codevalue)
  - Specify the Purpose Of Reference Code Value. Eg. 121320.*

### Protected Member Functions

- bool [AddDerivationDescription](#) ()
- bool [AddPurposeOfReferenceCodeSequence](#) ([DataSet](#) &ds)
- bool [AddSourceImageSequence](#) ()

#### 10.127.1 Detailed Description

[FileDerivation](#) class.

See PS 3.16 - 2008 For the list of Code [Value](#) that can be used for in Derivation Code Sequence

URL: [http://medical.nema.org/medical/dicom/2008/08\\_16pu.pdf](http://medical.nema.org/medical/dicom/2008/08_16pu.pdf)

DICOM Part 16 has two Context Groups CID 7202 and CID 7203 which contain a set of codes defining reason for a source image reference (ie. reason code for referenced image sequence) and a coded description of the derivation applied to the new image data from the original. Both these context groups are extensible.

[File](#) Derivation is compulsory when creating a lossy derived image.

#### Examples

[DeriveSeries.cxx](#), and [GenFakelImage.cxx](#).

## 10.127.2 Constructor & Destructor Documentation

### 10.127.2.1 FileDerivation()

```
gdcm::FileDerivation::FileDerivation ( )
```

### 10.127.2.2 ~FileDerivation()

```
gdcm::FileDerivation::~~FileDerivation ( )
```

## 10.127.3 Member Function Documentation

### 10.127.3.1 AddDerivationDescription()

```
bool gdcm::FileDerivation::AddDerivationDescription ( ) [protected]
```

### 10.127.3.2 AddPurposeOfReferenceCodeSequence()

```
bool gdcm::FileDerivation::AddPurposeOfReferenceCodeSequence (
    DataSet & ds ) [protected]
```

### 10.127.3.3 AddReference()

```
bool gdcm::FileDerivation::AddReference (
    const char * referencedSOPClassUID,
    const char * referencedSOPInstanceUID )
```

Create the proper reference. Need to pass the original SOP Class UID and the original SOP Instance UID, so that those value can be used as Reference.

#### Warning

referencedSOPClassUID and referencedSOPInstanceUID needs to be \0 padded. This is not compatible with how ByteValue->GetPointer works.

#### Examples

[DeriveSeries.cxx](#), and [GenFakelImage.cxx](#).

### 10.127.3.4 AddSourceImageSequence()

```
bool gdcM::FileDerivation::AddSourceImageSequence ( ) [protected]
```

### 10.127.3.5 Derive()

```
bool gdcM::FileDerivation::Derive ( )
```

Change.

#### Examples

[DeriveSeries.cxx](#), and [GenFakelImage.cxx](#).

### 10.127.3.6 GetFile() [1/2]

```
File& gdcM::FileDerivation::GetFile ( ) [inline]
```

#### Examples

[GenFakelImage.cxx](#).

### 10.127.3.7 GetFile() [2/2]

```
const File& gdcM::FileDerivation::GetFile ( ) const [inline]
```

### 10.127.3.8 SetAppendDerivationHistory()

```
void gdcM::FileDerivation::SetAppendDerivationHistory (
    bool b )
```

Specify if Derivation history should be appended (default false) When false, this is an error if input already has a derivation history When true, both Purpose of Reference Code [Value](#) and Derivation Code Sequence Code [Value](#) can have their history appended.

### 10.127.3.9 SetDerivationCodeSequenceCodeValue()

```
void gdcM::FileDerivation::SetDerivationCodeSequenceCodeValue (
    unsigned int codevalue )
```

Specify the Derivation Code Sequence Code [Value](#). Eg 113040.

#### Examples

[DeriveSeries.cxx](#), and [GenFakelImage.cxx](#).

### 10.127.3.10 SetDerivationDescription()

```
void gdcM::FileDerivation::SetDerivationDescription (
    const char * dd )
```

Specify the Derivation Description. Eg "lossy conversion".

### 10.127.3.11 SetFile()

```
void gdcM::FileDerivation::SetFile (
    const File & f ) [inline]
```

Set/Get [File](#).

#### Examples

[DeriveSeries.cxx](#), and [GenFakelImage.cxx](#).

### 10.127.3.12 SetPurposeOfReferenceCodeSequenceCodeValue()

```
void gdcM::FileDerivation::SetPurposeOfReferenceCodeSequenceCodeValue (
    unsigned int codevalue )
```

Specify the Purpose Of Reference Code [Value](#). Eg. 121320.

#### Examples

[DeriveSeries.cxx](#), and [GenFakelImage.cxx](#).

The documentation for this class was generated from the following file:

- [gdcMFileDerivation.h](#)

## 10.128 gdcm::FileExplicitFilter Class Reference

[FileExplicitFilter](#) class.

```
#include <gdcmFileExplicitFilter.h>
```

### Public Member Functions

- [FileExplicitFilter](#) ()
- [~FileExplicitFilter](#) ()=default
- bool [Change](#) ()
  - Set FMI Transfer Syntax.*
- [File](#) & [GetFile](#) ()
- void [SetChangePrivateTags](#) (bool b)
  - Decide whether or not to [VR](#)ify private tags.*
- void [SetFile](#) (const [File](#) &f)
  - Set/Get [File](#).*
- void [SetRecomputeItemLength](#) (bool b)
  - By default set [Sequence](#) & [Item](#) length to Undefined to avoid recomputing length:*
- void [SetRecomputeSequenceLength](#) (bool b)
- void [SetUseVRUN](#) (bool b)
  - When [VR](#)=16bits in explicit but Implicit has a 32bits length, use [VR](#)=UN.*

### Protected Member Functions

- bool [ChangeFMI](#) ()
- bool [ProcessDataSet](#) ([DataSet](#) &ds, [Dicts](#) const &dicts)

#### 10.128.1 Detailed Description

[FileExplicitFilter](#) class.

After changing a file from Implicit to Explicit representation (see [ImageChangeTransferSyntax](#)) one operation is to make sure the [VR](#) of each DICOM attribute are accurate and do match the one from PS 3.6. Indeed when a file is written in Implicit representation, the [VR](#) is not stored directly in the file.

#### Warning

changing an implicit dataset to an explicit dataset is NOT a trivial task of simply changing the [VR](#) to the dict one:

- One has to make sure SQ is properly set
- One has to recompute the explicit length SQ
- One has to make sure that [VR](#) is valid for the encoding
- One has to make sure that [VR](#) 16bits can store the original value length

#### Examples

[GenAllVR.cxx](#), and [LargeVRDSExplicit.cxx](#).

## 10.128.2 Constructor & Destructor Documentation

### 10.128.2.1 FileExplicitFilter()

```
gdcM::FileExplicitFilter::FileExplicitFilter ( ) [inline]
```

### 10.128.2.2 ~FileExplicitFilter()

```
gdcM::FileExplicitFilter::~~FileExplicitFilter ( ) [default]
```

## 10.128.3 Member Function Documentation

### 10.128.3.1 Change()

```
bool gdcM::FileExplicitFilter::Change ( )
```

Set FMI Transfer Syntax.

Change

#### Examples

[GenAIIVR.cxx](#), and [LargeVRDSEExplicit.cxx](#).

### 10.128.3.2 ChangeFMI()

```
bool gdcM::FileExplicitFilter::ChangeFMI ( ) [protected]
```

### 10.128.3.3 GetFile()

```
File& gdcM::FileExplicitFilter::GetFile ( ) [inline]
```



### 10.128.3.4 ProcessDataSet()

```
bool gdcM::FileExplicitFilter::ProcessDataSet (
    DataSet & ds,
    Dicts const & dicts ) [protected]
```

### 10.128.3.5 SetChangePrivateTags()

```
void gdcM::FileExplicitFilter::SetChangePrivateTags (
    bool b ) [inline]
```

Decide whether or not to [VR](#)ify private tags.

### 10.128.3.6 SetFile()

```
void gdcM::FileExplicitFilter::SetFile (
    const File & f ) [inline]
```

Set/Get [File](#).

#### Examples

[GenAllVR.cxx](#), and [LargeVRDSExplicit.cxx](#).

### 10.128.3.7 SetRecomputeItemLength()

```
void gdcM::FileExplicitFilter::SetRecomputeItemLength (
    bool b )
```

By default set Sequence & [Item](#) length to Undefined to avoid recomputing length:

### 10.128.3.8 SetRecomputeSequenceLength()

```
void gdcM::FileExplicitFilter::SetRecomputeSequenceLength (
    bool b )
```

### 10.128.3.9 SetUseVRUN()

```
void gdcM::FileExplicitFilter::SetUseVRUN (
    bool b ) [inline]
```

When VR=16bits in explicit but Implicit has a 32bits length, use VR=UN.

The documentation for this class was generated from the following file:

- [gdcMFileExplicitFilter.h](#)

## 10.129 gdcM::FileMetaInformation Class Reference

Class to represent a [File](#) Meta Information.

```
#include <gdcMFileMetaInformation.h>
```

Inheritance diagram for gdcM::FileMetaInformation:

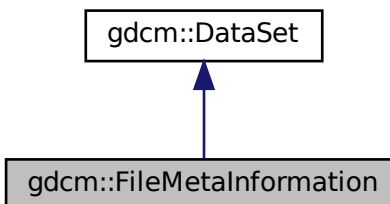

Collaboration diagram for gdcM::FileMetaInformation:

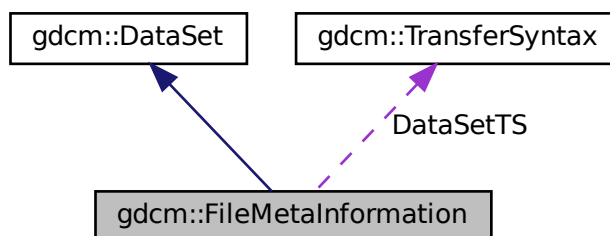

## Public Member Functions

- [FileMetalInformation](#) ()
- [FileMetalInformation](#) ([FileMetalInformation](#) const &fmi)
- [~FileMetalInformation](#) ()
- void [FillFromDataSet](#) ([DataSet](#) const &ds)
  - Construct a [FileMetalInformation](#) from an already existing [DataSet](#):*
- const [TransferSyntax](#) & [GetDataSetTransferSyntax](#) () const
- [VL](#) [GetFullLength](#) () const
- [MediaStorage](#) [GetMediaStorage](#) () const
- std::string [GetMediaStorageAsString](#) () const
- [TransferSyntax::NegociatedType](#) [GetMetalInformationTS](#) () const
- [Preamble](#) & [GetPreamble](#) ()
- const [Preamble](#) & [GetPreamble](#) () const
  - Get [Preamble](#).*
- void [Insert](#) (const [DataElement](#) &de)
- bool [IsValid](#) () const
- [FileMetalInformation](#) & [operator=](#) (const [FileMetalInformation](#) &fmi)
- std::istream & [Read](#) (std::istream &is)
  - Read.*
- std::istream & [ReadCompat](#) (std::istream &is)
- void [Replace](#) (const [DataElement](#) &de)
- void [SetDataSetTransferSyntax](#) (const [TransferSyntax](#) &ts)
- void [SetPreamble](#) (const [Preamble](#) &p)
- std::ostream & [Write](#) (std::ostream &os) const
  - Write.*

## Static Public Member Functions

- static void [AppendImplementationClassUID](#) (const char \*imp)
- static const char \* [GetImplementationClassUID](#) ()
- static const char \* [GetImplementationVersionName](#) ()
- static const char \* [GetSourceApplicationEntityTitle](#) ()
- static void [SetImplementationClassUID](#) (const char \*imp)
  - Override the [GDCM](#) default values:*
- static void [SetImplementationVersionName](#) (const char \*version)
- static void [SetSourceApplicationEntityTitle](#) (const char \*title)

## Protected Member Functions

- void [ComputeDataSetMediaStorageSOPClass](#) ()
- void [ComputeDataSetTransferSyntax](#) ()
- void [Default](#) ()
- template<typename TSwap >
  - std::istream & [ReadCompatInternal](#) (std::istream &is)

## Static Protected Member Functions

- static const char \* [GetFileMetaInformationVersion](#) ()
- static const char \* [GetGDCMImplementationClassUID](#) ()
- static const char \* [GetGDCMImplementationVersionName](#) ()
- static const char \* [GetGDCMSourceApplicationEntityTitle](#) ()

## Protected Attributes

- [MediaStorage::MSType DataSetMS](#)
- [TransferSyntax DataSetTS](#)
- [TransferSyntax::NegociatedType MetaInformationTS](#)

## Friends

- std::ostream & [operator<<](#) (std::ostream &\_os, const [FileMetaInformation](#) &\_val)

## Additional Inherited Members

### 10.129.1 Detailed Description

Class to represent a [File](#) Meta Information.

[FileMetaInformation](#) is a Explicit Structured Set. Whenever the file contains an [ImplicitDataElement DataSet](#), a conversion will take place.

Definition: The [File](#) Meta Information includes identifying information on the encapsulated Data Set. This header consists of a 128 byte [File Preamble](#), followed by a 4 byte DICOM prefix, followed by the [File](#) Meta Elements shown in [Table 7.1-1](#). This header shall be present in every DICOM file.

See also

[Writer Reader](#)

Examples

[DumpToshibaDTI.cxx](#), [DumpToshibaDTI2.cxx](#), [GenAllIVR.cxx](#), [GenFakeIdentifyFile.cxx](#), [LargeVRDSExplicit.cxx](#), [MakeTemplate.cxx](#), and [ReadAndDumpDICOMDIR.cxx](#).

### 10.129.2 Constructor & Destructor Documentation

### 10.129.2.1 FileMetaInformation() [1/2]

```
gdcm::FileMetaInformation::FileMetaInformation ( )
```

### 10.129.2.2 ~FileMetaInformation()

```
gdcm::FileMetaInformation::~~FileMetaInformation ( )
```

### 10.129.2.3 FileMetaInformation() [2/2]

```
gdcm::FileMetaInformation::FileMetaInformation (
    FileMetaInformation const & fmi ) [inline]
```

References DataSetMS, DataSetTS, and MetaInformationTS.

## 10.129.3 Member Function Documentation

### 10.129.3.1 AppendImplementationClassUID()

```
static void gdcm::FileMetaInformation::AppendImplementationClassUID (
    const char * imp ) [static]
```

### 10.129.3.2 ComputeDataSetMediaStorageSOPClass()

```
void gdcm::FileMetaInformation::ComputeDataSetMediaStorageSOPClass ( ) [protected]
```

### 10.129.3.3 ComputeDataSetTransferSyntax()

```
void gdcm::FileMetaInformation::ComputeDataSetTransferSyntax ( ) [protected]
```

#### 10.129.3.4 Default()

```
void gdcm::FileMetaInformation::Default ( ) [protected]
```

#### 10.129.3.5 FillFromDataSet()

```
void gdcm::FileMetaInformation::FillFromDataSet (
    DataSet const & ds )
```

Construct a [FileMetaInformation](#) from an already existing [DataSet](#):

#### 10.129.3.6 GetDataSetTransferSyntax()

```
const TransferSyntax& gdcm::FileMetaInformation::GetDataSetTransferSyntax ( ) const [inline]
```

#### Examples

[GetJPEGSamplePrecision.cxx](#), and [MergeTwoFiles.cxx](#).

#### 10.129.3.7 GetFileMetaInformationVersion()

```
static const char* gdcm::FileMetaInformation::GetFileMetaInformationVersion ( ) [static], [protected]
```

#### 10.129.3.8 GetFullLength()

```
VL gdcm::FileMetaInformation::GetFullLength ( ) const [inline]
```

References [gdcm::VL::GetLength\(\)](#).

#### 10.129.3.9 GetGDCMImplementationClassUID()

```
static const char* gdcm::FileMetaInformation::GetGDCMImplementationClassUID ( ) [static], [protected]
```

### 10.129.3.10 GetGDCMImplementationVersionName()

```
static const char* gdcM::FileMetaInformation::GetGDCMImplementationVersionName ( ) [static],  
[protected]
```

### 10.129.3.11 GetGDCMSourceApplicationEntityTitle()

```
static const char* gdcM::FileMetaInformation::GetGDCMSourceApplicationEntityTitle ( ) [static],  
[protected]
```

### 10.129.3.12 GetImplementationClassUID()

```
static const char* gdcM::FileMetaInformation::GetImplementationClassUID ( ) [static]
```

### 10.129.3.13 GetImplementationVersionName()

```
static const char* gdcM::FileMetaInformation::GetImplementationVersionName ( ) [static]
```

### 10.129.3.14 GetMediaStorage()

```
MediaStorage gdcM::FileMetaInformation::GetMediaStorage ( ) const
```

### 10.129.3.15 GetMediaStorageAsString()

```
std::string gdcM::FileMetaInformation::GetMediaStorageAsString ( ) const
```

### 10.129.3.16 GetMetaInformationTS()

```
TransferSyntax::NegociatedType gdcM::FileMetaInformation::GetMetaInformationTS ( ) const [inline]
```

### 10.129.3.17 GetPreamble() [1/2]

```
Preamble& gdcM::FileMetaInformation::GetPreamble ( ) [inline]
```

### 10.129.3.18 GetPreamble() [2/2]

```
const Preamble& gdcM::FileMetaInformation::GetPreamble ( ) const [inline]
```

Get [Preamble](#).

### 10.129.3.19 GetSourceApplicationEntityTitle()

```
static const char* gdcM::FileMetaInformation::GetSourceApplicationEntityTitle ( ) [static]
```

### 10.129.3.20 Insert()

```
void gdcM::FileMetaInformation::Insert (
    const DataElement & de ) [inline]
```

References [gdcMErrorMacro](#), [gdcM::Tag::GetGroup\(\)](#), and [gdcM::DataElement::GetTag\(\)](#).

### 10.129.3.21 IsValid()

```
bool gdcM::FileMetaInformation::IsValid ( ) const [inline]
```

### 10.129.3.22 operator=()

```
FileMetaInformation& gdcM::FileMetaInformation::operator= (
    const FileMetaInformation & fmi ) [inline]
```

References [DataSetMS](#), [DataSetTS](#), and [MetaInformationTS](#).



### 10.129.3.23 Read()

```
std::istream& gdcM::FileMetaInformation::Read (
    std::istream & is )
```

Read.

### 10.129.3.24 ReadCompat()

```
std::istream& gdcM::FileMetaInformation::ReadCompat (
    std::istream & is )
```

### 10.129.3.25 ReadCompatInternal()

```
template<typename TSwap >
std::istream& gdcM::FileMetaInformation::ReadCompatInternal (
    std::istream & is ) [protected]
```

### 10.129.3.26 Replace()

```
void gdcM::FileMetaInformation::Replace (
    const DataElement & de ) [inline]
```

#### Examples

[LargeVRDSExplicit.cxx](#).

References [gdcM::DataElement::GetTag\(\)](#).

### 10.129.3.27 SetDataSetTransferSyntax()

```
void gdcM::FileMetaInformation::SetDataSetTransferSyntax (
    const TransferSyntax & ts )
```

#### Examples

[CreateJPIPDataSet.cxx](#), [DumpToshibaDTI.cxx](#), [DumpToshibaDTI2.cxx](#), [EncapsulateFileInRawData.cxx](#), [Extracting\\_All\\_Resolution.cxx](#), [Fake\\_Image\\_Using\\_Stream\\_Image\\_Writer.cxx](#), [FixJAIBugJPEGLS.cxx](#), [GenAllVR.cxx](#), [GenFakeIdentifyFile.cxx](#), [LargeVRDSExplicit.cxx](#), [MakeTemplate.cxx](#), [MpegVideoInfo.cs](#), [QIDO-RS.cxx](#), [StreamImageReaderTest.cxx](#), [pmsct\\_rgb1.cxx](#), and [rle2img.cxx](#).

### 10.129.3.28 SetImplementationClassUID()

```
static void gdcM::FileMetaInformation::SetImplementationClassUID (
    const char * imp ) [static]
```

Override the GDCM default values:

### 10.129.3.29 SetImplementationVersionName()

```
static void gdcM::FileMetaInformation::SetImplementationVersionName (
    const char * version ) [static]
```

### 10.129.3.30 SetPreamble()

```
void gdcM::FileMetaInformation::SetPreamble (
    const Preamble & p ) [inline]
```

### 10.129.3.31 SetSourceApplicationEntityTitle()

```
static void gdcM::FileMetaInformation::SetSourceApplicationEntityTitle (
    const char * title ) [static]
```

#### Examples

[ClinicalTrialIdentificationWorkflow.cs](#), [FixJAIBugJPEGLS.cxx](#), [GenerateDICOMDIR.cs](#), [ReformatFile.cs](#), and [StandardizeFiles.cs](#).

### 10.129.3.32 Write()

```
std::ostream& gdcM::FileMetaInformation::Write (
    std::ostream & os ) const
```

Write.

## 10.129.4 Friends And Related Function Documentation

### 10.129.4.1 operator<<

```
std::ostream& operator<< (
    std::ostream & _os,
    const FileMetaInformation & _val ) [friend]
```

## 10.129.5 Member Data Documentation

### 10.129.5.1 DataSetMS

[MediaStorage::MSType](#) gdcm::FileMetaInformation::DataSetMS [protected]

Referenced by FileMetaInformation(), and operator=().

### 10.129.5.2 DataSetTS

[TransferSyntax](#) gdcm::FileMetaInformation::DataSetTS [protected]

Referenced by FileMetaInformation(), and operator=().

### 10.129.5.3 MetaInformationTS

[TransferSyntax::NegotiatedType](#) gdcm::FileMetaInformation::MetaInformationTS [protected]

Referenced by FileMetaInformation(), and operator=().

The documentation for this class was generated from the following file:

- [gdcmFileMetaInformation.h](#)

## 10.130 gdcm::Filename Class Reference

Class to manipulate file name's.

```
#include <gdcmFilename.h>
```

## Public Member Functions

- [Filename](#) (const char \*filename="")
- bool [EndWith](#) (const char ending[]) const  
*Does the filename ends with a particular string ?*
- const char \* [GetExtension](#) ()  
*return only the extension part of a filename*
- const char \* [GetFileName](#) () const  
*Return the full filename.*
- const char \* [GetName](#) ()  
*return only the name part of a filename*
- const char \* [GetPath](#) ()  
*Return only the path component of a filename.*
- bool [IsEmpty](#) () const  
*return whether the filename is empty*
- bool [IsIdentical](#) ([Filename](#) const &fn) const
- operator const char \* () const
- const char \* [ToUnixSlashes](#) ()  
*Convert backslash (windows style) to UNIX style slash.*
- const char \* [ToWindowsSlashes](#) ()  
*Convert forward slash (UNIX style) to windows style slash.*

## Static Public Member Functions

- static const char \* [Join](#) (const char \*path, const char \*filename)

### 10.130.1 Detailed Description

Class to manipulate file name's.

#### Note

OS independent representation of a filename (to query path, name and extension from a filename)

### 10.130.2 Constructor & Destructor Documentation

#### 10.130.2.1 [Filename\(\)](#)

```
gdcmm::Filename::Filename (
    const char * filename = "" ) [inline]
```

## 10.130.3 Member Function Documentation

### 10.130.3.1 EndWith()

```
bool gdcm::Filename::EndWith (
    const char ending[] ) const
```

Does the filename ends with a particular string ?

### 10.130.3.2 GetExtension()

```
const char* gdcm::Filename::GetExtension ( )
```

return only the extension part of a filename

### 10.130.3.3 GetFileName()

```
const char* gdcm::Filename::GetFileName ( ) const [inline]
```

Return the full filename.

### 10.130.3.4 GetName()

```
const char* gdcm::Filename::GetName ( )
```

return only the name part of a filename

### 10.130.3.5 GetPath()

```
const char* gdcm::Filename::GetPath ( )
```

Return only the path component of a filename.

#### Examples

[ClinicalTrialIdentificationWorkflow.cs](#).

### 10.130.3.6 IsEmpty()

```
bool gdcm::Filename::IsEmpty ( ) const [inline]
```

return whether the filename is empty

### 10.130.3.7 IsIdentical()

```
bool gdcm::Filename::IsIdentical (
    Filename const & fn ) const
```

### 10.130.3.8 Join()

```
static const char* gdcm::Filename::Join (
    const char * path,
    const char * filename ) [static]
```

Join two paths NOT THREAD SAFE

#### Examples

[BasicAnonymizer.cs](#), and [ClinicalTrialIdentificationWorkflow.cs](#).

### 10.130.3.9 operator const char \*()

```
gdcm::Filename::operator const char * ( ) const [inline]
```

Simple operator to allow `Filename myfilename( "...")`; `const char * s = myfilename`;

### 10.130.3.10 ToUnixSlashes()

```
const char* gdcm::Filename::ToUnixSlashes ( )
```

Convert backslash (windows style) to UNIX style slash.

### 10.130.3.11 ToWindowsSlashes()

```
const char* gdcm::Filename::ToWindowsSlashes ( )
```

Convert forward slash (UNIX style) to windows style slash.

The documentation for this class was generated from the following file:

- [gdcmFilename.h](#)

## 10.131 gdcm::FileNameEvent Class Reference

[FileNameEvent](#).

```
#include <gdcmFileNameEvent.h>
```

Inheritance diagram for gdcm::FileNameEvent:

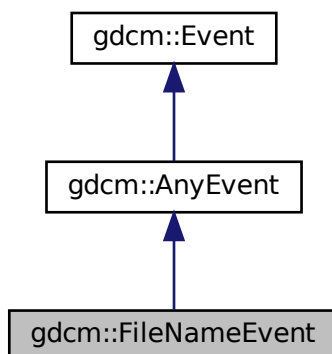

Collaboration diagram for `gdcM::FileNameEvent`:

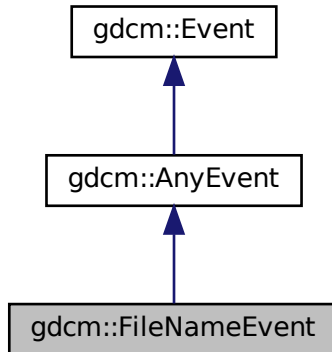

## Public Types

- typedef [FileNameEvent](#) `Self`
- typedef [AnyEvent](#) `Superclass`

## Public Member Functions

- [FileNameEvent](#) (`const char *s=""`)
- [FileNameEvent](#) (`const Self &s`)
- [~FileNameEvent](#) () `override=default`
- `bool` [CheckEvent](#) (`const ::gdcM::Event *e`) `const override`
- `const char *` [GetEventName](#) () `const override`
- `const char *` [GetFileName](#) () `const`
- `::gdcM::Event *` [MakeObject](#) () `const override`
- `void` `operator=` (`const Self &`)`=delete`
- `void` [SetFileName](#) (`const char *f`)

### 10.131.1 Detailed Description

[FileNameEvent](#).

Special type of event triggered during processing of [FileSet](#)

See also

[AnyEvent](#)

Examples

[SimpleScanner.cxx](#).



## 10.131.2 Member Typedef Documentation

### 10.131.2.1 Self

```
typedef FileNameEvent gdcM::FileNameEvent::Self
```

### 10.131.2.2 Superclass

```
typedef AnyEvent gdcM::FileNameEvent::Superclass
```

## 10.131.3 Constructor & Destructor Documentation

### 10.131.3.1 FileNameEvent() [1/2]

```
gdcM::FileNameEvent::FileNameEvent (
    const char * s = "" ) [inline]
```

### 10.131.3.2 ~FileNameEvent()

```
gdcM::FileNameEvent::~~FileNameEvent ( ) [override], [default]
```

### 10.131.3.3 FileNameEvent() [2/2]

```
gdcM::FileNameEvent::FileNameEvent (
    const Self & s ) [inline]
```

## 10.131.4 Member Function Documentation

#### 10.131.4.1 CheckEvent()

```
bool gdcM::FileNameEvent::CheckEvent (
    const ::gdcM::Event * e ) const [inline], [override]
```

#### 10.131.4.2 GetEventName()

```
const char* gdcM::FileNameEvent::GetEventName ( ) const [inline], [override], [virtual]
```

Return the StringName associated with the event.

Implements [gdcM::Event](#).

#### 10.131.4.3 GetFileName()

```
const char* gdcM::FileNameEvent::GetFileName ( ) const [inline]
```

#### Examples

[SimpleScanner.cxx](#).

#### 10.131.4.4 MakeObject()

```
::gdcM::Event* gdcM::FileNameEvent::MakeObject ( ) const [inline], [override], [virtual]
```

Create an [Event](#) of this type This method work as a Factory for creating events of each particular type.

Implements [gdcM::Event](#).

#### 10.131.4.5 operator=()

```
void gdcM::FileNameEvent::operator= (
    const Self & ) [delete]
```

### 10.131.4.6 SetFileName()

```
void gdcm::FileNameEvent::SetFileName (
    const char * f ) [inline]
```

The documentation for this class was generated from the following file:

- [gdcmFileNameEvent.h](#)

## 10.132 gdcm::FilenameGenerator Class Reference

[FilenameGenerator](#).

```
#include <gdcmFilenameGenerator.h>
```

### Public Types

- typedef std::vector< [FilenameType](#) > [FileNamesType](#)
- typedef std::string [FilenameType](#)
- typedef [FileNamesType](#)::size\_type [SizeType](#)

### Public Member Functions

- [FilenameGenerator](#) ()
- [~FilenameGenerator](#) ()=default
- bool [Generate](#) ()
  - Generate (return success)*
- const char \* [GetFilename](#) ([SizeType](#) n) const
  - Get a particular filename (call after Generate)*
- [FileNamesType](#) const & [GetFileNames](#) () const
  - Return all filenames.*
- [SizeType](#) [GetNumberOfFileNames](#) () const
- const char \* [GetPattern](#) () const
- const char \* [GetPrefix](#) () const
- void [SetNumberOfFileNames](#) ([SizeType](#) nfiles)
  - Set/Get the number of filenames to generate.*
- void [SetPattern](#) (const char \*pattern)
  - Set/Get pattern.*
- void [SetPrefix](#) (const char \*prefix)
  - Set/Get prefix.*

### 10.132.1 Detailed Description

[FilenameGenerator](#).

class to generate filenames based on a pattern (C-style)

Output will be:

for  $i = 0$ , number of filenames: `outfilename[i] = prefix + (pattern % i)`

where `pattern % i` means C-style `sprintf` of `Pattern` using value `'i'`

Examples

[ConvertMultiFrameToSingleFrame.cxx](#), and [CreateFakePET.cxx](#).

### 10.132.2 Member Typedef Documentation

#### 10.132.2.1 FilenamesType

```
typedef std::vector<FilenameType> gdcm::FilenameGenerator::FileNamesType
```

#### 10.132.2.2 FilenameType

```
typedef std::string gdcm::FilenameGenerator::FilenameType
```

#### 10.132.2.3 SizeType

```
typedef FileNamesType::size_type gdcm::FilenameGenerator::SizeType
```

### 10.132.3 Constructor & Destructor Documentation

### 10.132.3.1 FilenameGenerator()

```
gdcm::FilenameGenerator::FilenameGenerator ( ) [inline]
```

### 10.132.3.2 ~FilenameGenerator()

```
gdcm::FilenameGenerator::~~FilenameGenerator ( ) [default]
```

## 10.132.4 Member Function Documentation

### 10.132.4.1 Generate()

```
bool gdcm::FilenameGenerator::Generate ( )
```

Generate (return success)

#### Examples

[ConvertMultiFrameToSingleFrame.cxx](#), and [CreateFakePET.cxx](#).

### 10.132.4.2 GetFilename()

```
const char* gdcm::FilenameGenerator::GetFilename (
    SizeType n ) const
```

Get a particular filename (call after Generate)

#### Examples

[ConvertMultiFrameToSingleFrame.cxx](#), and [CreateFakePET.cxx](#).

### 10.132.4.3 GetFileNames()

```
FilenameType const& gdcm::FilenameGenerator::GetFileNames ( ) const [inline]
```

Return all filenames.

#### 10.132.4.4 GetNumberOfFileNames()

```
SizeType gdcm::FilenameGenerator::GetNumberOfFileNames ( ) const
```

##### Examples

[ConvertMultiFrameToSingleFrame.cxx](#), and [CreateFakePET.cxx](#).

#### 10.132.4.5 GetPattern()

```
const char* gdcm::FilenameGenerator::GetPattern ( ) const [inline]
```

#### 10.132.4.6 GetPrefix()

```
const char* gdcm::FilenameGenerator::GetPrefix ( ) const [inline]
```

#### 10.132.4.7 SetNumberOfFileNames()

```
void gdcm::FilenameGenerator::SetNumberOfFileNames (
    SizeType nfiles )
```

Set/Get the number of filenames to generate.

##### Examples

[ConvertMultiFrameToSingleFrame.cxx](#), and [CreateFakePET.cxx](#).

#### 10.132.4.8 SetPattern()

```
void gdcm::FilenameGenerator::SetPattern (
    const char * pattern ) [inline]
```

Set/Get pattern.

##### Examples

[ConvertMultiFrameToSingleFrame.cxx](#), and [CreateFakePET.cxx](#).

### 10.132.4.9 SetPrefix()

```
void gdcm::FilenameGenerator::SetPrefix (
    const char * prefix ) [inline]
```

Set/Get prefix.

The documentation for this class was generated from the following file:

- [gdcmFilenameGenerator.h](#)

## 10.133 gdcm::FileSet Class Reference

```
#include <gdcmFileSet.h>
```

### Public Types

- typedef std::vector< [FileType](#) > [FilesType](#)
- typedef std::string [FileType](#)

### Public Member Functions

- [FileSet](#) ()
- bool [AddFile](#) (const char \*filename)
- void [AddFile](#) ([File](#) const &)
- [FilesType](#) const & [GetFiles](#) () const
- void [SetFiles](#) ([FilesType](#) const &files)

### Friends

- std::ostream & [operator<<](#) (std::ostream &\_os, const [FileSet](#) &d)

### 10.133.1 Detailed Description

File-set: A File-set is a collection of DICOM Files (and possibly non-DICOM Files) that share a common naming space within which [File](#) IDs are unique.

### 10.133.2 Member Typedef Documentation

### 10.133.2.1 FileType

```
typedef std::vector<FileType> gdcm::FileSet::FileType
```

### 10.133.2.2 FileType

```
typedef std::string gdcm::FileSet::FileType
```

## 10.133.3 Constructor & Destructor Documentation

### 10.133.3.1 FileSet()

```
gdcm::FileSet::FileSet ( ) [inline]
```

## 10.133.4 Member Function Documentation

### 10.133.4.1 AddFile() [1/2]

```
bool gdcm::FileSet::AddFile (
    const char * filename )
```

Add a file 'filename' to the list of files. Return true on success, false in case filename could not be found on system.

### 10.133.4.2 AddFile() [2/2]

```
void gdcm::FileSet::AddFile (
    File const & ) [inline]
```

**Deprecated** . Does nothing



### 10.133.4.3 GetFiles()

```
FileType const& gdcm::FileSet::GetFiles ( ) const [inline]
```

### 10.133.4.4 SetFiles()

```
void gdcm::FileSet::SetFiles (
    FileType const & files )
```

## 10.133.5 Friends And Related Function Documentation

### 10.133.5.1 operator<<

```
std::ostream& operator<< (
    std::ostream & _os,
    const FileSet & d ) [friend]
```

The documentation for this class was generated from the following file:

- [gdcmFileSet.h](#)

## 10.134 gdcm::FileStreamer Class Reference

[FileStreamer](#).

```
#include <gdcmFileStreamer.h>
```

Inheritance diagram for gdcm::FileStreamer:

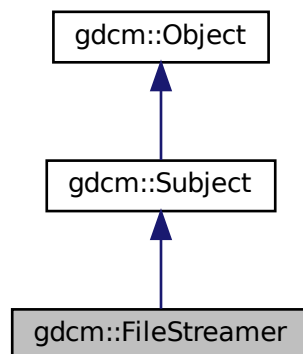

Collaboration diagram for `gdcm::FileStreamer`:

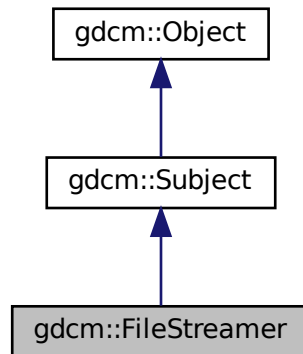

## Public Member Functions

- [FileStreamer](#) ()
- [~FileStreamer](#) () override
- bool [AppendToDataElement](#) (const [Tag](#) &t, const char \*array, size\_t len)
  - Append to previously started [Tag](#) t.*
- bool [AppendToGroupDataElement](#) (const [PrivateTag](#) &pt, const char \*array, size\_t len)
  - Append to previously started private creator.*
- bool [CheckDataElement](#) (const [Tag](#) &t)
- void [CheckTemplateFileName](#) (bool check)
- bool [ReserveDataElement](#) (size\_t len)
- bool [ReserveGroupDataElement](#) (unsigned short ndataelement)
- void [SetOutputFileName](#) (const char \*filename\_native)
  - Set output filename (target file)*
- void [SetTemplateFileName](#) (const char \*filename\_native)
  - Set input DICOM template filename.*
- bool [StartDataElement](#) (const [Tag](#) &t)
- bool [StartGroupDataElement](#) (const [PrivateTag](#) &pt, size\_t maxsize=0, uint8\_t startoffset=0)
- bool [StopDataElement](#) (const [Tag](#) &t)
  - Stop appending to tag t. This will compute the proper attribute length.*
- bool [StopGroupDataElement](#) (const [PrivateTag](#) &pt)
  - Stop appending to private creator.*

## Static Public Member Functions

- static [SmartPointer](#)< [FileStreamer](#) > [New](#) ()
  - for wrapped language: instantiate a reference counted object*

## Additional Inherited Members

### 10.134.1 Detailed Description

[FileStreamer](#).

This class let a user create a massive DICOM [DataSet](#) from a template DICOM file, by appending chunks of data.

This class support two mode of operation:

1. Creating a single [DataElement](#) by appending chunk after chunk of data.
2. Creating a set of [DataElement](#) within the same group, using a private creator for start. New [DataElement](#) are added any time the user defined maximum size for data element is reached.

#### Warning

any existing [DataElement](#) is removed, pick carefully which [DataElement](#) to add.

### 10.134.2 Constructor & Destructor Documentation

#### 10.134.2.1 FileStreamer()

```
gdcm::FileStreamer::FileStreamer ( )
```

#### 10.134.2.2 ~FileStreamer()

```
gdcm::FileStreamer::~~FileStreamer ( ) [override]
```

### 10.134.3 Member Function Documentation

#### 10.134.3.1 AppendToDataElement()

```
bool gdcm::FileStreamer::AppendToDataElement (
    const Tag & t,
    const char * array,
    size_t len )
```

Append to previously started [Tag](#) t.

### 10.134.3.2 AppendToGroupDataElement()

```
bool gdcM::FileStreamer::AppendToGroupDataElement (
    const PrivateTag & pt,
    const char * array,
    size_t len )
```

Append to previously started private creator.

### 10.134.3.3 CheckDataElement()

```
bool gdcM::FileStreamer::CheckDataElement (
    const Tag & t )
```

Decide to check the Data Element to be written (default: off) The implementation has default strategy for checking validity of DataElement. Currently it only support checking for the following tags:

- (7fe0,0010) Pixel Data

### 10.134.3.4 CheckTemplateFileName()

```
void gdcM::FileStreamer::CheckTemplateFileName (
    bool check )
```

Instead of simply blindly copying the input DICOM Template file, GDCM will be used to check the input file, and correct any issues recognized within the file. Only use if you do not have control over the input template file.

### 10.134.3.5 New()

```
static SmartPointer<FileStreamer> gdcM::FileStreamer::New ( ) [inline], [static]
```

for wrapped language: instantiate a reference counted object

### 10.134.3.6 ReserveDataElement()

```
bool gdcM::FileStreamer::ReserveDataElement (
    size_t len )
```

Add a hint on the final size of the dataelement. When optimally chosen, this reduce the number of file in-place copying. Should be called before StartDataElement

### 10.134.3.7 ReserveGroupDataElement()

```
bool gdcM::FileStreamer::ReserveGroupDataElement (
    unsigned short ndataelement )
```

Optimisation: pre-allocate the number of dataelement within the private group (ndataelement <= 256). Should be called before StartGroupDataElement

### 10.134.3.8 SetOutputFileName()

```
void gdcM::FileStreamer::SetOutputFileName (
    const char * filename_native )
```

Set output filename (target file)

### 10.134.3.9 SetTemplateFileName()

```
void gdcM::FileStreamer::SetTemplateFileName (
    const char * filename_native )
```

Set input DICOM template filename.

#### Examples

[FileStreaming.cs](#).

### 10.134.3.10 StartDataElement()

```
bool gdcM::FileStreamer::StartDataElement (
    const Tag & t )
```

Start Single Data [Element](#) Operation This will delete any existing [Tag](#) t. Need to call it only once.

### 10.134.3.11 StartGroupDataElement()

```
bool gdcM::FileStreamer::StartGroupDataElement (
    const PrivateTag & pt,
    size_t maxsize = 0,
    uint8_t startoffset = 0 )
```

Start Private Group (multiple [DataElement](#)) Operation. Each newly added [DataElement](#) will have a length lower than

## Parameters

<i>maxsize</i>	. When not specified, maxsize is set to maximum size allowed by DICOM ( $= 2^{32}$ ). startoffset can be used to specify the very first element you want to start with (instead of the first possible). Value should be in [0x0, 0xff] This will find the first available private creator.
----------------	--

**Bug** maxsize should be a value lower than the actual total size of the buffer to be copied

### 10.134.3.12 StopDataElement()

```
bool gdcM::FileStreamer::StopDataElement (
    const Tag & t )
```

Stop appending to tag t. This will compute the proper attribute length.

### 10.134.3.13 StopGroupDataElement()

```
bool gdcM::FileStreamer::StopGroupDataElement (
    const PrivateTag & pt )
```

Stop appending to private creator.

The documentation for this class was generated from the following file:

- [gdcMFileStreamer.h](#)

## 10.135 gdcM::FileWithName Class Reference

[FileWithName](#).

```
#include <gdcMSerieHelper.h>
```

Inheritance diagram for gdcm::FileWithName:

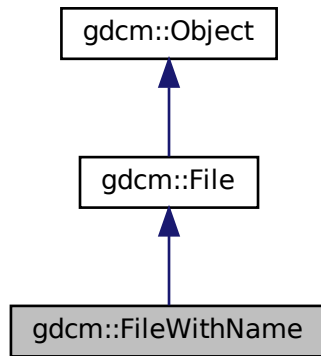

Collaboration diagram for gdcm::FileWithName:

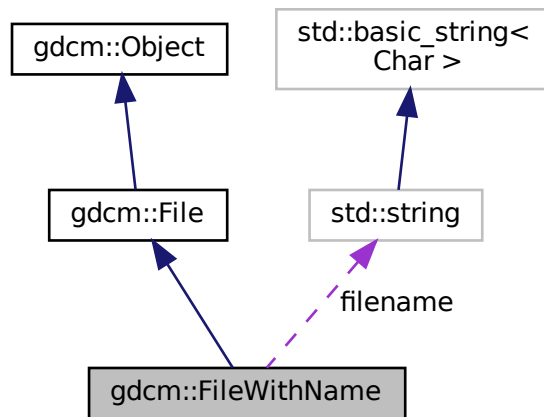

## Public Member Functions

- [FileWithName](#) (`File &f`)

## Public Attributes

- `std::string` [filename](#)

## Additional Inherited Members

### 10.135.1 Detailed Description

[FileWithName.](#)

Backward only class do not use in newer code

### 10.135.2 Constructor & Destructor Documentation

#### 10.135.2.1 FileWithName()

```
gdcm::FileWithName::FileWithName (  
    File & f ) [inline]
```

### 10.135.3 Member Data Documentation

#### 10.135.3.1 filename

```
std::string gdcm::FileWithName::filename
```

The documentation for this class was generated from the following file:

- [gdcmSerieHelper.h](#)



## 10.136 gdcm::FindPatientRootQuery Class Reference

PatientRootQuery.

```
#include <gdcmFindPatientRootQuery.h>
```

Inheritance diagram for gdcm::FindPatientRootQuery:

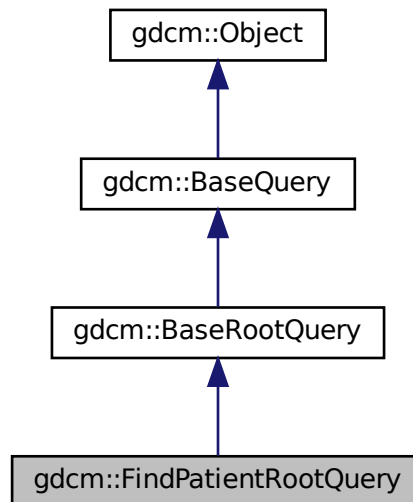

Collaboration diagram for gdcm::FindPatientRootQuery:

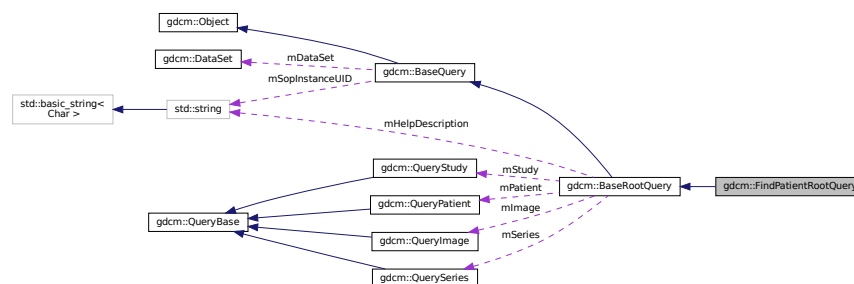

### Public Member Functions

- `FindPatientRootQuery ()`
- `UIDs::TSName GetAbstractSyntaxUID ()` const override
- `std::vector< Tag > GetTagListByLevel (const EQueryLevel &inQueryLevel)` override
- `void InitializeDataSet (const EQueryLevel &inQueryLevel)` override
- `bool ValidateQuery (bool inStrict=true)` const override

## Friends

- class [QueryFactory](#)

## Additional Inherited Members

### 10.136.1 Detailed Description

PatientRootQuery.

contains: the class which will produce a dataset for c-find with patient root

### 10.136.2 Constructor & Destructor Documentation

#### 10.136.2.1 FindPatientRootQuery()

```
gdcM::FindPatientRootQuery::FindPatientRootQuery ( )
```

### 10.136.3 Member Function Documentation

#### 10.136.3.1 GetAbstractSyntaxUID()

```
UIDs::TSName gdcM::FindPatientRootQuery::GetAbstractSyntaxUID ( ) const [override], [virtual]
```

Implements [gdcM::BaseQuery](#).

#### 10.136.3.2 GetTagListByLevel()

```
std::vector<Tag> gdcM::FindPatientRootQuery::GetTagListByLevel (
    const EQueryLevel & inQueryLevel ) [override], [virtual]
```

this function will return all tags at a given query level, so that they maybe selected for searching. The boolean forFind is true if the query is a find query, or false for a move query.

Implements [gdcM::BaseRootQuery](#).

### 10.136.3.3 InitializeDataSet()

```
void gdcM::FindPatientRootQuery::InitializeDataSet (
    const EQueryLevel & inQueryLevel ) [override], [virtual]
```

this function sets tag 8,52 to the appropriate value based on query level also fills in the right unique tags, as per the standard's requirements should allow for connection with dcmTk

Implements [gdcM::BaseRootQuery](#).

### 10.136.3.4 ValidateQuery()

```
bool gdcM::FindPatientRootQuery::ValidateQuery (
    bool inStrict = true ) const [override], [virtual]
```

have to be able to ensure that 0x8,0x52 is set (which will be true if InitializeDataSet is called...) that the level is appropriate (ie, not setting PATIENT for a study query that the tags in the query match the right level (either required, unique, optional) by default, this function checks to see if the query is for finding, which is more permissive than for moving. For moving, only the unique tags are allowed. 10 Jan 2011: adding in the 'strict' mode. according to the standard (at least, how I've read it), only tags for a particular level should be allowed in a particular query (ie, just series level tags in a series level query). However, it seems that dcm4chee doesn't share that interpretation. So, if 'inStrict' is false, then tags from the current level and all higher levels are now considered valid. So, if you're doing a non-strict series-level query, tags from the patient and study level can be passed along as well.

Implements [gdcM::BaseRootQuery](#).

## 10.136.4 Friends And Related Function Documentation

### 10.136.4.1 QueryFactory

```
friend class QueryFactory [friend]
```

The documentation for this class was generated from the following file:

- [gdcMFindPatientRootQuery.h](#)

## 10.137 gdcM::FindStudyRootQuery Class Reference

[FindStudyRootQuery](#).

```
#include <gdcMFindStudyRootQuery.h>
```

Inheritance diagram for gdcM::FindStudyRootQuery:

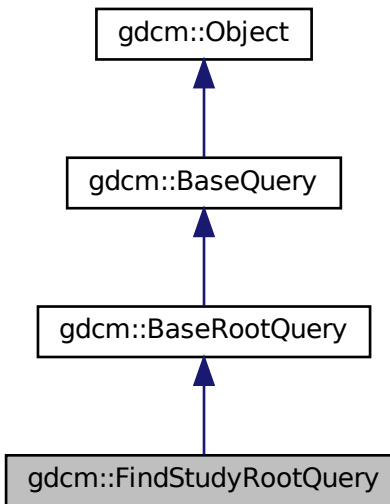

Collaboration diagram for gdcM::FindStudyRootQuery:

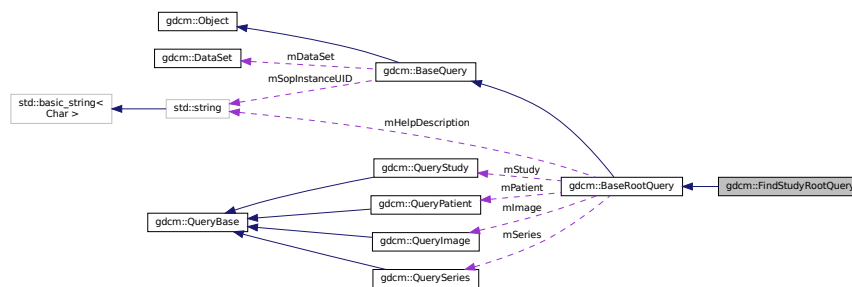

### Public Member Functions

- [FindStudyRootQuery](#) ()
- [UIDs::TSName GetAbstractSyntaxUID](#) () const override
- `std::vector< Tag >` [GetTagListByLevel](#) (const [EQueryLevel](#) &inQueryLevel) override
- void [InitializeDataSet](#) (const [EQueryLevel](#) &inQueryLevel) override
- bool [ValidateQuery](#) (bool inStrict=true) const override

## Friends

- class [QueryFactory](#)

## Additional Inherited Members

### 10.137.1 Detailed Description

[FindStudyRootQuery](#).

contains: the class which will produce a dataset for C-FIND with study root

### 10.137.2 Constructor & Destructor Documentation

#### 10.137.2.1 FindStudyRootQuery()

```
gdcm::FindStudyRootQuery::FindStudyRootQuery ( )
```

### 10.137.3 Member Function Documentation

#### 10.137.3.1 GetAbstractSyntaxUID()

```
UIDs::TSName gdcm::FindStudyRootQuery::GetAbstractSyntaxUID ( ) const [override], [virtual]
```

Implements [gdcm::BaseQuery](#).

#### 10.137.3.2 GetTagListByLevel()

```
std::vector<Tag> gdcm::FindStudyRootQuery::GetTagListByLevel (
    const EQueryLevel & inQueryLevel ) [override], [virtual]
```

this function will return all tags at a given query level, so that they maybe selected for searching. The boolean forFind is true if the query is a find query, or false for a move query.

Implements [gdcm::BaseRootQuery](#).

### 10.137.3.3 InitializeDataSet()

```
void gdcM::FindStudyRootQuery::InitializeDataSet (
    const EQueryLevel & inQueryLevel ) [override], [virtual]
```

this function sets tag 8,52 to the appropriate value based on query level also fills in the right unique tags, as per the standard's requirements should allow for connection with dcmTk

Implements [gdcM::BaseRootQuery](#).

### 10.137.3.4 ValidateQuery()

```
bool gdcM::FindStudyRootQuery::ValidateQuery (
    bool inStrict = true ) const [override], [virtual]
```

have to be able to ensure that (0008,0052) is set that the level is appropriate (ie, not setting PATIENT for a study query that the tags in the query match the right level (either required, unique, optional)

Implements [gdcM::BaseRootQuery](#).

## 10.137.4 Friends And Related Function Documentation

### 10.137.4.1 QueryFactory

```
friend class QueryFactory [friend]
```

The documentation for this class was generated from the following file:

- [gdcMFindStudyRootQuery.h](#)

## 10.138 gdcM::Fragment Class Reference

Class to represent a [Fragment](#).

```
#include <gdcMFragment.h>
```

Inheritance diagram for gdcM::Fragment:

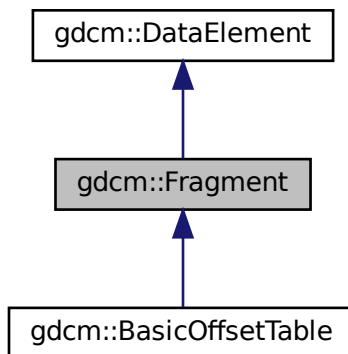

Collaboration diagram for gdcM::Fragment:

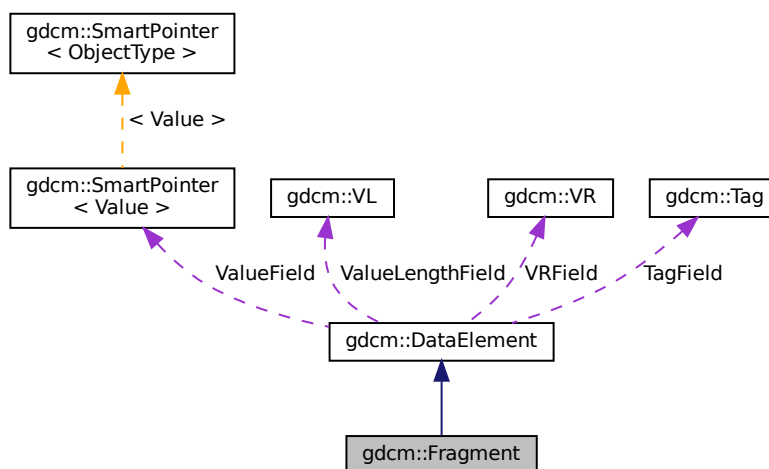

## Public Member Functions

- [Fragment](#) ()
- [VL ComputeLength](#) () const
- [VL GetLength](#) () const
- `template<typename TSwap >`  
`std::istream & Read (std::istream &is)`
- `template<typename TSwap >`  
`std::istream & ReadBacktrack (std::istream &is)`
- `template<typename TSwap >`  
`std::istream & ReadPreValue (std::istream &is)`
- `template<typename TSwap >`  
`std::istream & ReadValue (std::istream &is)`
- `template<typename TSwap >`  
`std::ostream & Write (std::ostream &os) const`

## Friends

- `std::ostream & operator<< (std::ostream &os, const Fragment &val)`

## Additional Inherited Members

### 10.138.1 Detailed Description

Class to represent a [Fragment](#).

#### Examples

[FixBrokenJ2K.cxx](#), and [FixJAIBugJPEGLS.cxx](#).

### 10.138.2 Constructor & Destructor Documentation

#### 10.138.2.1 [Fragment\(\)](#)

```
gdcm::Fragment::Fragment ( ) [inline]
```

### 10.138.3 Member Function Documentation



### 10.138.3.1 ComputeLength()

```
VL gdcm::Fragment::ComputeLength ( ) const
```

### 10.138.3.2 GetLength()

```
VL gdcm::Fragment::GetLength ( ) const
```

### 10.138.3.3 Read()

```
template<typename TSwap >  
std::istream& gdcm::Fragment::Read (  
    std::istream & is ) [inline]
```

Referenced by `gdcm::SequenceOfFragments::ReadValue()`.

### 10.138.3.4 ReadBacktrack()

```
template<typename TSwap >  
std::istream& gdcm::Fragment::ReadBacktrack (  
    std::istream & is ) [inline]
```

References `gdcmErrorMacro`, `gdcmWarningMacro`, and `gdcm::ParseException::SetLastElement()`.

Referenced by `gdcm::SequenceOfFragments::ReadValue()`.

### 10.138.3.5 ReadPreValue()

```
template<typename TSwap >  
std::istream& gdcm::Fragment::ReadPreValue (  
    std::istream & is ) [inline]
```

### 10.138.3.6 ReadValue()

```
template<typename TSwap >
std::istream& gdcM::Fragment::ReadValue (
    std::istream & is ) [inline]
```

References `gdcMWarningMacro`, and `gdcM::ParseException::SetLastElement()`.

### 10.138.3.7 Write()

```
template<typename TSwap >
std::ostream& gdcM::Fragment::Write (
    std::ostream & os ) const [inline]
```

References `gdcM::ByteValue::ComputeLength()`, `gdcM::ByteValue::GetLength()`, `gdcM::ByteValue::Write()`, and `gdcM::VL::Write()`.

## 10.138.4 Friends And Related Function Documentation

### 10.138.4.1 operator<<

```
std::ostream& operator<< (
    std::ostream & os,
    const Fragment & val ) [friend]
```

The documentation for this class was generated from the following file:

- [gdcMFragment.h](#)

## 10.139 gdcM::Global Class Reference

[Global](#).

```
#include <gdcMGlobal.h>
```

## Public Member Functions

- [Global](#) ()
- [Global](#) (const [Global](#) &\_val)=delete
- [~Global](#) ()
- bool [Append](#) (const char \*path)
- [Defs](#) const & [GetDefs](#) () const
- [Dicts](#) & [GetDicts](#) ()
- [Dicts](#) const & [GetDicts](#) () const
- bool [LoadResourcesFiles](#) ()
- [Global](#) & [operator=](#) (const [Global](#) &\_val)=delete
- bool [Prepend](#) (const char \*path)

## Static Public Member Functions

- static [Global](#) & [GetInstance](#) ()  
*return the singleton instance*

## Protected Member Functions

- const char \* [Locate](#) (const char \*resfile) const  
*Locate a resource file.*

## Friends

- std::ostream & [operator<<](#) (std::ostream &\_os, const [Global](#) &g)

### 10.139.1 Detailed Description

[Global](#).

#### Note

[Global](#) should be included in any translation unit that will use [Dict](#) or that implements the singleton pattern. It makes sure that the [Dict](#) singleton is created before and destroyed after all other singletons in GDCM.

#### Examples

[GenAllVR.cxx](#), [GenFakeIdentifyFile.cxx](#), [GenerateStandardSOPClasses.cxx](#), [PublicDict.cxx](#), and [ReadAndPrintAttributes.cxx](#).

### 10.139.2 Constructor & Destructor Documentation

### 10.139.2.1 Global() [1/2]

```
gdcM::Global::Global ( )
```

### 10.139.2.2 ~Global()

```
gdcM::Global::~~Global ( )
```

### 10.139.2.3 Global() [2/2]

```
gdcM::Global::Global (
    const Global & _val ) [delete]
```

## 10.139.3 Member Function Documentation

### 10.139.3.1 Append()

```
bool gdcM::Global::Append (
    const char * path )
```

Append path at the end of the path list

#### Warning

not thread safe !

### 10.139.3.2 GetDefs()

```
Defs const& gdcM::Global::GetDefs ( ) const
```

retrieve the default/internal (Part 3) You need to explicitly call LoadResourcesFiles before

#### Examples

[GenerateStandardSOPClasses.cxx](#).

### 10.139.3.3 GetDicts() [1/2]

```
Dicts& gdcM::Global::GetDicts ( )
```

### 10.139.3.4 GetDicts() [2/2]

```
Dicts const& gdcM::Global::GetDicts ( ) const
```

retrieve the default/internal dicts (Part 6) This dict is filled up at load time

#### Examples

[GenAllVR.cxx](#), [GenFakeIdentifyFile.cxx](#), [MrProtocol.cxx](#), [PublicDict.cxx](#), and [ReadAndPrintAttributes.cxx](#).

### 10.139.3.5 GetInstance()

```
static Global& gdcM::Global::GetInstance ( ) [static]
```

return the singleton instance

#### Examples

[BasicAnonymizer.cs](#), [ClinicalTrialIdentificationWorkflow.cs](#), [GenAllVR.cxx](#), [GenFakeIdentifyFile.cxx](#), [GenerateStandardSOPClasses.cxx](#), [MrProtocol.cxx](#), [PublicDict.cxx](#), [ReadAndPrintAttributes.cxx](#), and [TraverseModules.cxx](#).

### 10.139.3.6 LoadResourcesFiles()

```
bool gdcM::Global::LoadResourcesFiles ( )
```

Load all internal XML files, resource path need to have been set before calling this member function (see [Appendix A](#) Prepend members func)

#### Warning

not thread safe !

#### Examples

[GenerateStandardSOPClasses.cxx](#).

### 10.139.3.7 Locate()

```
const char* gdcm::Global::Locate (
    const char * resfile ) const [protected]
```

Locate a resource file.

### 10.139.3.8 operator=()

```
Global& gdcm::Global::operator= (
    const Global & _val ) [delete]
```

### 10.139.3.9 Prepend()

```
bool gdcm::Global::Prepend (
    const char * path )
```

Prepend path at the beginning of the path list

#### Warning

not thread safe !

## 10.139.4 Friends And Related Function Documentation

### 10.139.4.1 operator<<

```
std::ostream& operator<< (
    std::ostream & _os,
    const Global & g ) [friend]
```

The documentation for this class was generated from the following file:

- [gdcmGlobal.h](#)

## 10.140 gdcm::GroupDict Class Reference

Class to represent the mapping from group number to its abbreviation and name.

```
#include <gdcmGroupDict.h>
```

## Public Types

- typedef std::vector< std::string > [GroupStringVector](#)

## Public Member Functions

- [GroupDict](#) ()
- [~GroupDict](#) ()=default
- std::string const & [GetAbbreviation](#) (uint16\_t num) const
- std::string const & [GetName](#) (uint16\_t num) const
- size\_t [Size](#) () const

## Protected Member Functions

- void [Add](#) (std::string const &abbreviation, std::string const &name)
- void [Insert](#) (uint16\_t num, std::string const &abbreviation, std::string const &name)

## Friends

- std::ostream & [operator<<](#) (std::ostream &\_os, const [GroupDict](#) &\_val)

### 10.140.1 Detailed Description

Class to represent the mapping from group number to its abbreviation and name.

#### Note

Should I rewrite this class to use a std::map instead of std::vector for problem of memory consumption ?

### 10.140.2 Member Typedef Documentation

#### 10.140.2.1 GroupStringVector

```
typedef std::vector<std::string> gdcM::GroupDict::GroupStringVector
```

### 10.140.3 Constructor & Destructor Documentation

### 10.140.3.1 GroupDict()

```
gdcM::GroupDict::GroupDict ( ) [inline]
```

### 10.140.3.2 ~GroupDict()

```
gdcM::GroupDict::~~GroupDict ( ) [default]
```

## 10.140.4 Member Function Documentation

### 10.140.4.1 Add()

```
void gdcM::GroupDict::Add (
    std::string const & abbreviation,
    std::string const & name ) [protected]
```

### 10.140.4.2 GetAbbreviation()

```
std::string const& gdcM::GroupDict::GetAbbreviation (
    uint16_t num ) const
```

### 10.140.4.3 GetName()

```
std::string const& gdcM::GroupDict::GetName (
    uint16_t num ) const
```

### 10.140.4.4 Insert()

```
void gdcM::GroupDict::Insert (
    uint16_t num,
    std::string const & abbreviation,
    std::string const & name ) [protected]
```



### 10.140.4.5 Size()

```
size_t gdcm::GroupDict::Size ( ) const [inline]
```

## 10.140.5 Friends And Related Function Documentation

### 10.140.5.1 operator<<

```
std::ostream& operator<< (
    std::ostream & _os,
    const GroupDict & _val ) [friend]
```

The documentation for this class was generated from the following file:

- [gdcmGroupDict.h](#)

## 10.141 gdcm::IconImageFilter Class Reference

[IconImageFilter](#).

```
#include <gdcmIconImageFilter.h>
```

### Public Member Functions

- [IconImageFilter](#) ()
- [~IconImageFilter](#) ()
- bool [Extract](#) ()
  - Extract all Icon found in File.*
- [File](#) & [GetFile](#) ()
- const [File](#) & [GetFile](#) () const
- [IconImage](#) & [GetIconImage](#) (unsigned int i) const
- unsigned int [GetNumberOfIconImages](#) () const
  - Retrieve extract IconImage (need to call Extract first)*
- void [SetFile](#) (const [File](#) &f)
  - Set/Get File.*

### Protected Member Functions

- void [ExtractIconImages](#) ()
- void [ExtractVeprolIconImages](#) ()

### 10.141.1 Detailed Description

#### [IconImageFilter](#).

This filter will extract icons from a [File](#) This filter will loop over all known sequence (public and private) that may contains an [IconImage](#) and retrieve them. The filter will fails with a value of false if no icon can be found Since it handle both public and private icon type, one should not assume the icon is in uncompress form, some private vendor store private icon in JPEG8/JPEG12

Implementation details: This filter supports the following Icons:

- (0088,0200) Icon [Image](#) Sequence
- (0009,10,GEIIS) GE IIS Thumbnail Sequence
- (6003,10,GEMS\_Ultrasound\_ImageGroup\_001) GEMS [Image](#) Thumbnail Sequence
- (0055,30,VEPRO VIF 3.0 DATA) Icon Data
- (0055,30,VEPRO VIM 5.0 DATA) ICONDATA2

#### Warning

the icon stored in those private attribute do not conform to definition of Icon [Image](#) Sequence (do not simply copy/paste). For example some private icon can be expressed as 12bits pixel, while the DICOM standard only allow 8bits icons.

#### See also

[ImageReader](#)

#### Examples

[ExtractIconFromFile.cxx](#).

### 10.141.2 Constructor & Destructor Documentation

#### 10.141.2.1 [IconImageFilter\(\)](#)

```
gdcm::IconImageFilter::IconImageFilter ( )
```

#### 10.141.2.2 [~IconImageFilter\(\)](#)

```
gdcm::IconImageFilter::~~IconImageFilter ( )
```

## 10.141.3 Member Function Documentation

### 10.141.3.1 Extract()

```
bool gdcm::IconImageFilter::Extract ( )
```

Extract all Icon found in [File](#).

#### Examples

[ExtractIconFromFile.cxx](#).

### 10.141.3.2 ExtractIconImages()

```
void gdcm::IconImageFilter::ExtractIconImages ( ) [protected]
```

### 10.141.3.3 ExtractVeprolIconImages()

```
void gdcm::IconImageFilter::ExtractVeproIconImages ( ) [protected]
```

### 10.141.3.4 GetFile() [1/2]

```
File& gdcm::IconImageFilter::GetFile ( ) [inline]
```

### 10.141.3.5 GetFile() [2/2]

```
const File& gdcm::IconImageFilter::GetFile ( ) const [inline]
```

### 10.141.3.6 GetIconImage()

```
IconImage& gdcM::IconImageFilter::GetIconImage (
    unsigned int i ) const
```

#### Examples

[ExtractIconFromFile.cxx](#).

### 10.141.3.7 GetNumberOfIconImages()

```
unsigned int gdcM::IconImageFilter::GetNumberOfIconImages ( ) const
```

Retrieve extract IconImage (need to call Extract first)

#### Examples

[ExtractIconFromFile.cxx](#).

### 10.141.3.8 SetFile()

```
void gdcM::IconImageFilter::SetFile (
    const File & f ) [inline]
```

Set/Get [File](#).

#### Examples

[ExtractIconFromFile.cxx](#).

The documentation for this class was generated from the following file:

- [gdcMIconImageFilter.h](#)

## 10.142 gdcM::IconImageGenerator Class Reference

[IconImageGenerator](#).

```
#include <gdcMIconImageGenerator.h>
```

## Public Member Functions

- [IconImageGenerator](#) ()
- [~IconImageGenerator](#) ()
- void [AutoPixelMinMax](#) (bool b)
- void [ConvertRGBToPaletteColor](#) (bool b)
- bool [Generate](#) ()  
*Generate Icon.*
- const [IconImage](#) & [GetIconImage](#) () const  
*Retrieve generated Icon.*
- [Pixmap](#) & [GetPixmap](#) ()
- const [Pixmap](#) & [GetPixmap](#) () const
- void [SetOutputDimensions](#) (const unsigned int dims[2])  
*Set Target dimension of output Icon.*
- void [SetOutsideValuePixel](#) (double v)
- void [SetPixelMinMax](#) (double min, double max)
- void [SetPixmap](#) (const [Pixmap](#) &p)  
*Set/Get File.*

### 10.142.1 Detailed Description

[IconImageGenerator](#).

This filter will generate a valid Icon from the Pixel Data element (an instance of [Pixmap](#)). To generate a valid Icon, one is only allowed the following Photometric Interpretation:

- MONOCHROME1
- MONOCHROME2
- PALETTE\_COLOR

The Pixel Bits Allocated is restricted to 8bits, therefore 16 bits image needs to be rescaled. By default the filter will use the full scalar range of 16bits image to rescale to unsigned 8bits. This may not be ideal for some situation, in which case the API [SetPixelMinMax](#) can be used to overwrite the default min,max interval used.

See also

[ImageReader](#)

Examples

[ExtractIconFromFile.cxx](#).

### 10.142.2 Constructor & Destructor Documentation

### 10.142.2.1 IconImageGenerator()

```
gdcM::IconImageGenerator::IconImageGenerator ( )
```

### 10.142.2.2 ~IconImageGenerator()

```
gdcM::IconImageGenerator::~~IconImageGenerator ( )
```

## 10.142.3 Member Function Documentation

### 10.142.3.1 AutoPixelMinMax()

```
void gdcM::IconImageGenerator::AutoPixelMinMax (
    bool b )
```

Instead of explicitly specifying the min/max value for the rescale operation, let the internal mechanism compute the min/max of icon and rescale to best appropriate.

#### Examples

[ExtractIconFromFile.cxx](#).

### 10.142.3.2 ConvertRGBToPaletteColor()

```
void gdcM::IconImageGenerator::ConvertRGBToPaletteColor (
    bool b )
```

Converting from RGB to PALETTE\_COLOR can be a slow operation. However DICOM standard requires that color icon be described as palette. Set this boolean to false only if you understand the consequences. default value is true, false generates invalid Icon [Image](#) Sequence

### 10.142.3.3 Generate()

```
bool gdcM::IconImageGenerator::Generate ( )
```

Generate Icon.

#### Examples

[ExtractIconFromFile.cxx](#).

### 10.142.3.4 GetIconImage()

```
const IconImage& gdcm::IconImageGenerator::GetIconImage ( ) const [inline]
```

Retrieve generated Icon.

#### Examples

[ExtractIconFromFile.cxx](#).

### 10.142.3.5 GetPixmap() [1/2]

```
Pixmap& gdcm::IconImageGenerator::GetPixmap ( ) [inline]
```

### 10.142.3.6 GetPixmap() [2/2]

```
const Pixmap& gdcm::IconImageGenerator::GetPixmap ( ) const [inline]
```

### 10.142.3.7 SetOutputDimensions()

```
void gdcm::IconImageGenerator::SetOutputDimensions (
    const unsigned int dims[2] )
```

Set Target dimension of output Icon.

#### Examples

[ExtractIconFromFile.cxx](#).

### 10.142.3.8 SetOutsideValuePixel()

```
void gdcm::IconImageGenerator::SetOutsideValuePixel (
    double v )
```

Set a pixel value that should be discarded. This happen typically for CT image, where a pixel has been used to pad outside the image (see Pixel Padding [Value](#)). Requires `AutoPixelMinMax(true)`

### 10.142.3.9 SetPixelMinMax()

```
void gdcM::IconImageGenerator::SetPixelMinMax (
    double min,
    double max )
```

Override default min/max to compute best rescale for 16bits -> 8bits downscale. Typically those value can be read from the SmallestImagePixelValue LargestImagePixelValue DICOM attribute.

### 10.142.3.10 SetPixmap()

```
void gdcM::IconImageGenerator::SetPixmap (
    const Pixmap & p ) [inline]
```

Set/Get [File](#).

#### Examples

[ExtractIconFromFile.cxx](#).

The documentation for this class was generated from the following file:

- [gdcMIconImageGenerator.h](#)

## 10.143 gdcM::ignore\_char Struct Reference

```
#include <gdcMElement.h>
```

### Public Member Functions

- [ignore\\_char](#) (char c)

### Public Attributes

- char [m\\_char](#)

### 10.143.1 Constructor & Destructor Documentation



### 10.143.1.1 ignore\_char()

```
gdcm::ignore_char::ignore_char (  
    char c ) [inline]
```

## 10.143.2 Member Data Documentation

### 10.143.2.1 m\_char

```
char gdcm::ignore_char::m_char
```

Referenced by `gdcm::operator>>()`.

The documentation for this struct was generated from the following file:

- [gdcmElement.h](#)

## 10.144 gdcm::Image Class Reference

[Image](#).

```
#include <gdcmImage.h>
```

Inheritance diagram for `gdcm::Image`:

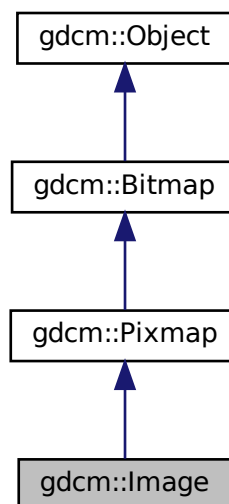

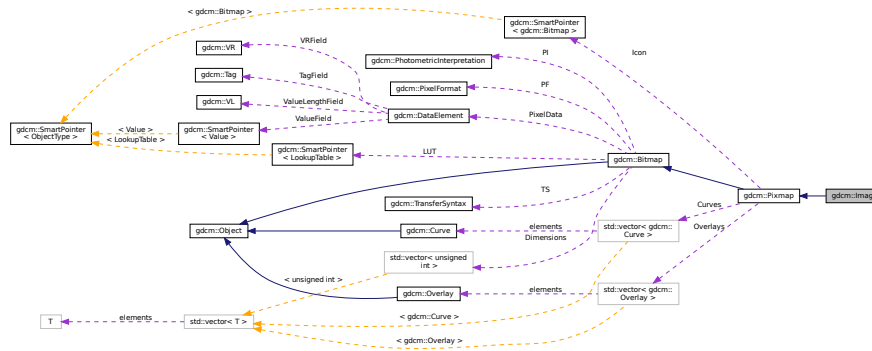
Collaboration diagram for `gdcm::Image`:

## Public Member Functions

- [Image](#) ()
  - [~Image](#) () override=default
  - `const double * GetDirectionCosines () const`
  - `double GetDirectionCosines (unsigned int idx) const`
  - `double GetIntercept () const`
  - `const double * GetOrigin () const`
  - `double GetOrigin (unsigned int idx) const`
  - `double GetSlope () const`
  - `const double * GetSpacing () const`
  - `double GetSpacing (unsigned int idx) const`
  - `void Print (std::ostream &os) const override`
- print*
- `void SetDirectionCosines (const double dircos[6])`
  - `void SetDirectionCosines (const float dircos[6])`
  - `void SetDirectionCosines (unsigned int idx, double dircos)`
  - `void SetIntercept (double intercept)`
- intercept*
- `void SetOrigin (const double origin[3])`
  - `void SetOrigin (const float origin[3])`
  - `void SetOrigin (unsigned int idx, double ori)`
  - `void SetSlope (double slope)`
- slope*
- `void SetSpacing (const double spacing[3])`
  - `void SetSpacing (unsigned int idx, double spacing)`

## Additional Inherited Members

### 10.144.1 Detailed Description

[Image](#).

This is the container for an [Image](#) in the general sense. From this container you should be able to request information like:

- Origin
- Dimension
- [PixelFormat](#) ... But also to retrieve the image as a raw buffer (char \*) Since we have to deal with both RAW data and JPEG stream (which internally encode all the above information) this API might seem redundant. One way to solve that would be to subclass [Image](#) with [JPEGImage](#) which would from the stream extract the header info and fill it to please [Image](#)...well except origin for instance

Basically you can see it as a storage for the Pixel Data element (7fe0,0010).

#### Warning

This class does some heuristics to guess the [Spacing](#) but is not compatible with DICOM CP-586. In case of doubt use [PixmapReader](#) instead

#### See also

[ImageReader](#) [PixmapReader](#)

#### Examples

[CompressImage.cxx](#), [ConvertToQImage.cxx](#), [CreateARGBImage.cxx](#), [CreateCMYKImage.cxx](#), [ExtractIconFromFile.cxx](#), [FixJAIBugJPEGLS.cxx](#), [GenFakeImage.cxx](#), [GetJPEGSamplePrecision.cxx](#), [GetSubSequenceData.cxx](#), [HelloVizWorld.cxx](#), [PatchFile.cxx](#), [PrintLUT.cxx](#), [ReadMultiTimesException.cxx](#), [TemplateEmptyImage.cxx](#), [csa2img.cxx](#), [iU22tomultisc.cxx](#), and [threadgdcmm.cxx](#).

### 10.144.2 Constructor & Destructor Documentation

#### 10.144.2.1 Image()

```
gdcmm::Image::Image ( ) [inline]
```

### 10.144.2.2 ~Image()

```
gdcM::Image::~~Image ( ) [override], [default]
```

## 10.144.3 Member Function Documentation

### 10.144.3.1 GetDirectionCosines() [1/2]

```
const double* gdcM::Image::GetDirectionCosines ( ) const
```

Return a 6-tuples specifying the direction cosines A default value of (1,0,0,0,1,0) will be return when the direction cosines was not specified.

### 10.144.3.2 GetDirectionCosines() [2/2]

```
double gdcM::Image::GetDirectionCosines (
    unsigned int idx ) const
```

### 10.144.3.3 GetIntercept()

```
double gdcM::Image::GetIntercept ( ) const [inline]
```

### 10.144.3.4 GetOrigin() [1/2]

```
const double* gdcM::Image::GetOrigin ( ) const
```

Return a 3-tuples specifying the origin Will return (0,0,0) if the origin was not specified.

#### Examples

[HelloVizWorld.cxx](#).

### 10.144.3.5 GetOrigin() [2/2]

```
double gdcM::Image::GetOrigin (
    unsigned int idx ) const
```

### 10.144.3.6 GetSlope()

```
double gdcM::Image::GetSlope ( ) const [inline]
```

### 10.144.3.7 GetSpacing() [1/2]

```
const double* gdcM::Image::GetSpacing ( ) const
```

Return a 3-tuples specifying the spacing NOTE: 3rd value can be an arbitrary 1 value when the spacing was not specified (ex. 2D image). WARNING: when the spacing is not specifier, a default value of 1 will be returned

### 10.144.3.8 GetSpacing() [2/2]

```
double gdcM::Image::GetSpacing (
    unsigned int idx ) const
```

### 10.144.3.9 Print()

```
void gdcM::Image::Print (
    std::ostream & os ) const [override], [virtual]
```

print

Reimplemented from [gdcM::Bitmap](#).

#### Examples

[CompressImage.cxx](#), and [PatchFile.cxx](#).

**10.144.3.10 SetDirectionCosines()** [1/3]

```
void gdcM::Image::SetDirectionCosines (
    const double dircos[6] )
```

**10.144.3.11 SetDirectionCosines()** [2/3]

```
void gdcM::Image::SetDirectionCosines (
    const float dircos[6] )
```

**10.144.3.12 SetDirectionCosines()** [3/3]

```
void gdcM::Image::SetDirectionCosines (
    unsigned int idx,
    double dircos )
```

**10.144.3.13 SetIntercept()**

```
void gdcM::Image::SetIntercept (
    double intercept ) [inline]
```

intercept

**Examples**

[TemplateEmptyImage.cxx](#).

**10.144.3.14 SetOrigin()** [1/3]

```
void gdcM::Image::SetOrigin (
    const double origin[3] )
```

**10.144.3.15 SetOrigin() [2/3]**

```
void gdcM::Image::SetOrigin (
    const float origin[3] )
```

**10.144.3.16 SetOrigin() [3/3]**

```
void gdcM::Image::SetOrigin (
    unsigned int idx,
    double ori )
```

**10.144.3.17 SetSlope()**

```
void gdcM::Image::SetSlope (
    double slope ) [inline]
```

*slope*

**Examples**

[TemplateEmptyImage.cxx](#).

**10.144.3.18 SetSpacing() [1/2]**

```
void gdcM::Image::SetSpacing (
    const double spacing[3] )
```

**Examples**

[csa2img.cxx](#), and [iU22tomultisc.cxx](#).

**10.144.3.19 SetSpacing() [2/2]**

```
void gdcM::Image::SetSpacing (
    unsigned int idx,
    double spacing )
```

The documentation for this class was generated from the following file:

- [gdcMImage.h](#)

## 10.145 gdcM::ImageApplyLookupTable Class Reference

[ImageApplyLookupTable](#) class.

```
#include <gdcMImageApplyLookupTable.h>
```

Inheritance diagram for gdcM::ImageApplyLookupTable:

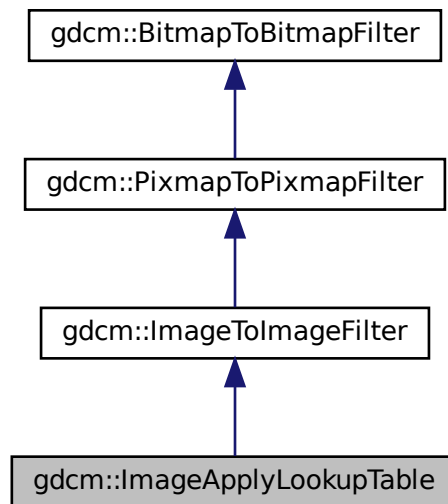



Collaboration diagram for gdcm::ImageApplyLookupTable:

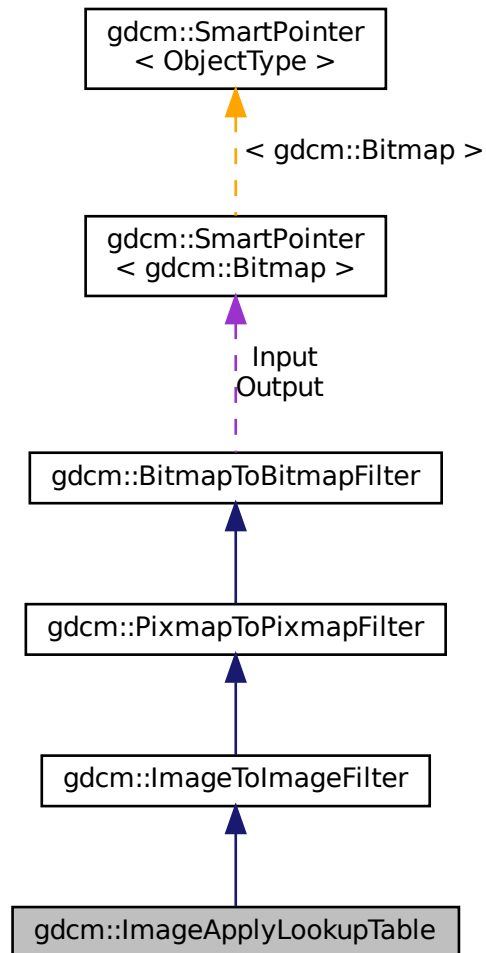

## Public Member Functions

- [ImageApplyLookupTable](#) ()
- [~ImageApplyLookupTable](#) ()
- [bool Apply](#) ()  
*Apply.*
- [void SetRGB8](#) (bool b)  
*RGB8 ?*

## Additional Inherited Members

### 10.145.1 Detailed Description

[ImageApplyLookupTable](#) class.

It applies the LUT the PixelData (only PALETTE\_COLOR images) Output will be a [PhotometricInterpretation=RGB](#) image

### 10.145.2 Constructor & Destructor Documentation

#### 10.145.2.1 ImageApplyLookupTable()

```
gdcmm::ImageApplyLookupTable::ImageApplyLookupTable ( )
```

#### 10.145.2.2 ~ImageApplyLookupTable()

```
gdcmm::ImageApplyLookupTable::~~ImageApplyLookupTable ( )
```

### 10.145.3 Member Function Documentation

#### 10.145.3.1 Apply()

```
bool gdcmm::ImageApplyLookupTable::Apply ( )
```

Apply.

#### 10.145.3.2 SetRGB8()

```
void gdcmm::ImageApplyLookupTable::SetRGB8 (
    bool b )
```

RGB8 ?

The documentation for this class was generated from the following file:

- [gdcmmImageApplyLookupTable.h](#)

## 10.146 gdcm::ImageChangePhotometricInterpretation Class Reference

[ImageChangePhotometricInterpretation](#) class.

```
#include <gdcmImageChangePhotometricInterpretation.h>
```

Inheritance diagram for gdcm::ImageChangePhotometricInterpretation:

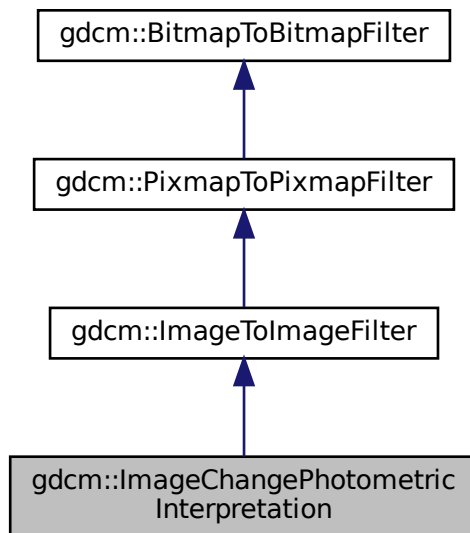

Collaboration diagram for `gdcm::ImageChangePhotometricInterpretation`:

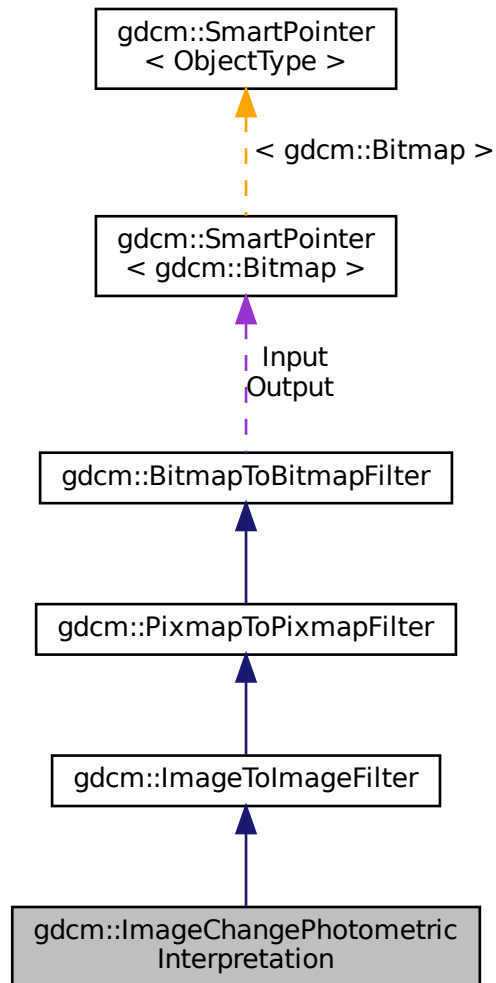

## Public Member Functions

- [ImageChangePhotometricInterpretation \(\)](#)
- [~ImageChangePhotometricInterpretation \(\)=default](#)
- `bool Change ()`  
*Change.*
- `const PhotometricInterpretation & GetPhotometricInterpretation () const`
- `void SetPhotometricInterpretation (PhotometricInterpretation const &pi)`  
*Set/Get requested PhotometricInterpretation.*

## Static Public Member Functions

- `template<typename T >`  
static void [RGB2YBR](#) (T ybr[3], const T rgb[3], unsigned short storedbits=8)
- `template<typename T >`  
static void [YBR2RGB](#) (T rgb[3], const T ybr[3], unsigned short storedbits=8)

## Protected Member Functions

- bool [ChangeMonochrome](#) ()
- bool [ChangeRGB2YBR](#) ()
- bool [ChangeYBR2RGB](#) ()

## Additional Inherited Members

### 10.146.1 Detailed Description

[ImageChangePhotometricInterpretation](#) class.

Class to change the Photometric Interpretation of an input DICOM

### 10.146.2 Constructor & Destructor Documentation

#### 10.146.2.1 ImageChangePhotometricInterpretation()

```
gdcm::ImageChangePhotometricInterpretation::ImageChangePhotometricInterpretation ( ) [inline]
```

#### 10.146.2.2 ~ImageChangePhotometricInterpretation()

```
gdcm::ImageChangePhotometricInterpretation::~~ImageChangePhotometricInterpretation ( ) [default]
```

### 10.146.3 Member Function Documentation

### 10.146.3.1 Change()

```
bool gdcm::ImageChangePhotometricInterpretation::Change ( )
```

Change.

### 10.146.3.2 ChangeMonochrome()

```
bool gdcm::ImageChangePhotometricInterpretation::ChangeMonochrome ( ) [protected]
```

### 10.146.3.3 ChangeRGB2YBR()

```
bool gdcm::ImageChangePhotometricInterpretation::ChangeRGB2YBR ( ) [protected]
```

### 10.146.3.4 ChangeYBR2RGB()

```
bool gdcm::ImageChangePhotometricInterpretation::ChangeYBR2RGB ( ) [protected]
```

### 10.146.3.5 GetPhotometricInterpretation()

```
const PhotometricInterpretation& gdcm::ImageChangePhotometricInterpretation::GetPhotometric↔  
Interpretation ( ) const [inline]
```

### 10.146.3.6 RGB2YBR()

```
template<typename T >  
void gdcm::ImageChangePhotometricInterpretation::RGB2YBR (   
    T ybr[3],  
    const T rgb[3],  
    unsigned short storedbits = 8 ) [static]
```

colorspace conversion (based on CCIR Recommendation 601-2) -> T.871

References gdcm::Round().

**10.146.3.7 SetPhotometricInterpretation()**

```
void gdcm::ImageChangePhotometricInterpretation::SetPhotometricInterpretation (
    PhotometricInterpretation const & pi ) [inline]
```

Set/Get requested [PhotometricInterpretation](#).

**10.146.3.8 YBR2RGB()**

```
template<typename T >
void gdcm::ImageChangePhotometricInterpretation::YBR2RGB (
    T rgb[3],
    const T ybr[3],
    unsigned short storedbits = 8 ) [static]
```

References [gdcm::Round\(\)](#).

The documentation for this class was generated from the following file:

- [gdcmImageChangePhotometricInterpretation.h](#)

**10.147 gdcm::ImageChangePlanarConfiguration Class Reference**

[ImageChangePlanarConfiguration](#) class.

```
#include <gdcmImageChangePlanarConfiguration.h>
```

Inheritance diagram for [gdcm::ImageChangePlanarConfiguration](#):

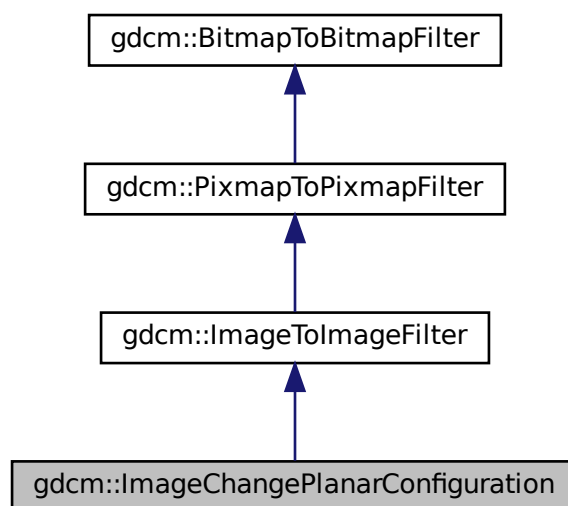

Collaboration diagram for `gdcM::ImageChangePlanarConfiguration`:

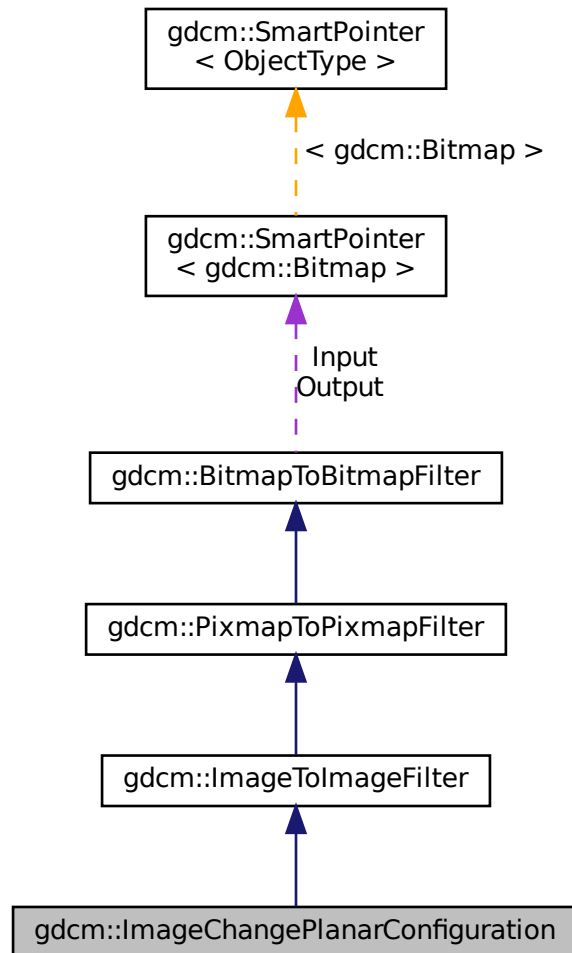

## Public Member Functions

- [ImageChangePlanarConfiguration \(\)](#)
- [~ImageChangePlanarConfiguration \(\)=default](#)
- `bool Change ()`  
*Change.*
- `unsigned int GetPlanarConfiguration () const`
- `void SetPlanarConfiguration (unsigned int pc)`  
*Set/Get requested PlanarConfiguration.*



## Static Public Member Functions

- `template<typename T >`  
`static size_t RGBPixelsToRGBPlanes (T *r, T *g, T *b, const T *rgb, size_t s)`
- `template<typename T >`  
`static size_t RGBPlanesToRGBPixels (T *out, const T *r, const T *g, const T *b, size_t s)`

## Additional Inherited Members

### 10.147.1 Detailed Description

[ImageChangePlanarConfiguration](#) class.

Class to change the Planar configuration of an input DICOM By default it will change into the more usual representation: PlanarConfiguration = 0

### 10.147.2 Constructor & Destructor Documentation

#### 10.147.2.1 ImageChangePlanarConfiguration()

```
gdcm::ImageChangePlanarConfiguration::ImageChangePlanarConfiguration ( ) [inline]
```

#### 10.147.2.2 ~ImageChangePlanarConfiguration()

```
gdcm::ImageChangePlanarConfiguration::~ImageChangePlanarConfiguration ( ) [default]
```

### 10.147.3 Member Function Documentation

#### 10.147.3.1 Change()

```
bool gdcm::ImageChangePlanarConfiguration::Change ( )
```

Change.

### 10.147.3.2 GetPlanarConfiguration()

```
unsigned int gdcM::ImageChangePlanarConfiguration::GetPlanarConfiguration ( ) const [inline]
```

### 10.147.3.3 RGBPixelsToRGBPlanes()

```
template<typename T >
size_t gdcM::ImageChangePlanarConfiguration::RGBPixelsToRGBPlanes (
    T * r,
    T * g,
    T * b,
    const T * rgb,
    size_t s ) [static]
```

Convert a regular RGB pixel image (R,G,B,R,G,B...) into a planar R,G,B image (R,R...,G,G...B,B)

#### Warning

this works on a frame basis, you need to loop over all frames in multiple frames image to apply this function

### 10.147.3.4 RGBPlanesToRGBPixels()

```
template<typename T >
size_t gdcM::ImageChangePlanarConfiguration::RGBPlanesToRGBPixels (
    T * out,
    const T * r,
    const T * g,
    const T * b,
    size_t s ) [static]
```

s is the size of one plane (r,g or b). Thus the output buffer needs to be at least 3\*s bytes long s can be seen as the number of RGB pixels in the output

### 10.147.3.5 SetPlanarConfiguration()

```
void gdcM::ImageChangePlanarConfiguration::SetPlanarConfiguration (
    unsigned int pc ) [inline]
```

Set/Get requested PlanarConfiguration.

The documentation for this class was generated from the following file:

- [gdcMImageChangePlanarConfiguration.h](#)

## 10.148 gdcm::ImageChangeTransferSyntax Class Reference

[ImageChangeTransferSyntax](#) class.

```
#include <gdcmImageChangeTransferSyntax.h>
```

Inheritance diagram for gdcm::ImageChangeTransferSyntax:

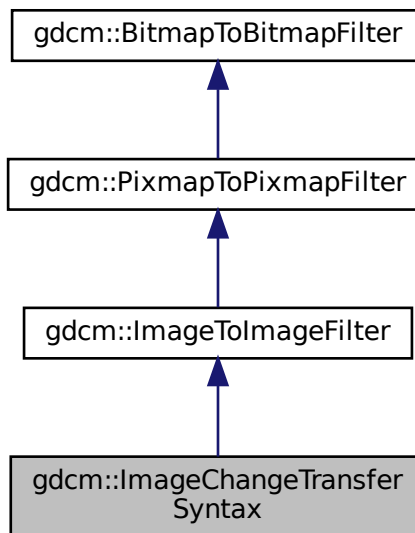

Collaboration diagram for `gdcm::ImageChangeTransferSyntax`:

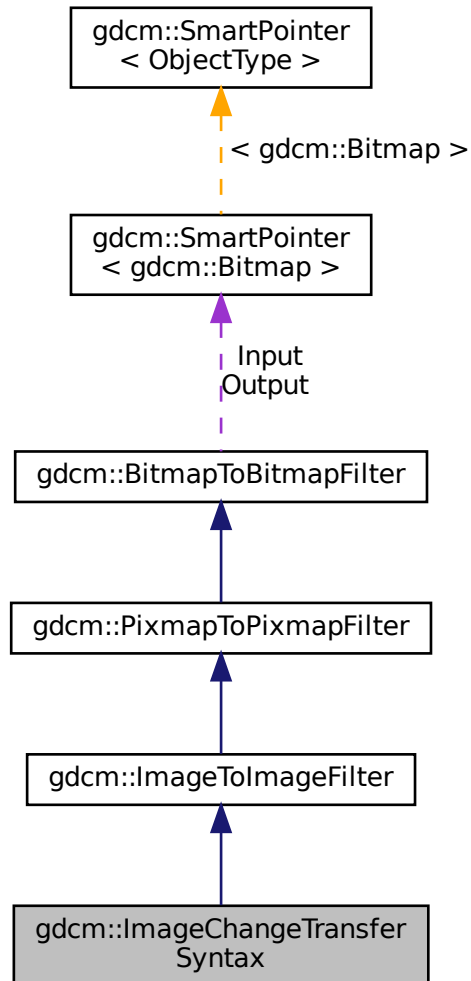

## Public Member Functions

- `ImageChangeTransferSyntax ()`
- `~ImageChangeTransferSyntax ()=default`
- `bool Change ()`  
*Change.*
- `const TransferSyntax & GetTransferSyntax () const`  
*Get Transfer Syntax.*
- `void SetCompressIconImage (bool b)`
- `void SetForce (bool f)`
- `void SetTransferSyntax (const TransferSyntax &ts)`

*Set target Transfer Syntax.*

- void [SetUserCodec](#) ([ImageCodec](#) \*ic)

## Protected Member Functions

- bool [TryJPEG2000Codec](#) (const [DataElement](#) &pixelde, [Bitmap](#) const &input, [Bitmap](#) &output)
- bool [TryJPEGCodec](#) (const [DataElement](#) &pixelde, [Bitmap](#) const &input, [Bitmap](#) &output)
- bool [TryJPEGLSCodec](#) (const [DataElement](#) &pixelde, [Bitmap](#) const &input, [Bitmap](#) &output)
- bool [TryRAWCodec](#) (const [DataElement](#) &pixelde, [Bitmap](#) const &input, [Bitmap](#) &output)
- bool [TryRLECodec](#) (const [DataElement](#) &pixelde, [Bitmap](#) const &input, [Bitmap](#) &output)

## Additional Inherited Members

### 10.148.1 Detailed Description

[ImageChangeTransferSyntax](#) class.

Class to change the transfer syntax of an input DICOM

If only Force param is set but no input [TransferSyntax](#) is set, it is assumed that user only wants to inspect encapsulated stream (advanced dev. option).

When using UserCodec it is very important that the [TransferSyntax](#) (as set in SetTransferSyntax) is actually understood by UserCodec (ie. UserCodec->CanCode( TransferSyntax ) ). Otherwise the behavior is to use a default codec.

See also

[JPEGCodec](#) [JPEGLSCodec](#) [JPEG2000Codec](#)

Examples

[CompressImage.cxx](#).

### 10.148.2 Constructor & Destructor Documentation

#### 10.148.2.1 ImageChangeTransferSyntax()

```
gdcm::ImageChangeTransferSyntax::ImageChangeTransferSyntax ( ) [inline]
```

#### 10.148.2.2 ~ImageChangeTransferSyntax()

```
gdcm::ImageChangeTransferSyntax::~ImageChangeTransferSyntax ( ) [default]
```

### 10.148.3 Member Function Documentation

#### 10.148.3.1 Change()

```
bool gdcM::ImageChangeTransferSyntax::Change ( )
```

Change.

#### Examples

[CompressImage.cxx](#).

#### 10.148.3.2 GetTransferSyntax()

```
const TransferSyntax& gdcM::ImageChangeTransferSyntax::GetTransferSyntax ( ) const [inline]
```

Get Transfer Syntax.

#### 10.148.3.3 SetCompressIconImage()

```
void gdcM::ImageChangeTransferSyntax::SetCompressIconImage (
    bool b ) [inline]
```

Decide whether or not to also compress the Icon [Image](#) using the same Transfer Syntax. Default is to simply decompress icon image

#### 10.148.3.4 SetForce()

```
void gdcM::ImageChangeTransferSyntax::SetForce (
    bool f ) [inline]
```

When target Transfer Syntax is identical to input target syntax, no operation is actually done. This is an issue when someone wants to re-compress using GDCM internal implementation a JPEG (for example) image

### 10.148.3.5 SetTransferSyntax()

```
void gdcm::ImageChangeTransferSyntax::SetTransferSyntax (
    const TransferSyntax & ts ) [inline]
```

Set target Transfer Syntax.

#### Examples

[CompressImage.cxx](#).

### 10.148.3.6 SetUserCodec()

```
void gdcm::ImageChangeTransferSyntax::SetUserCodec (
    ImageCodec * ic ) [inline]
```

Allow user to specify exactly which codec to use. this is needed to specify special qualities or compression option.

#### Warning

if the codec 'ic' is not compatible with the [TransferSyntax](#) requested, it will not be used. It is the user responsibility to check that `UserCodec->CanCode( TransferSyntax )`

### 10.148.3.7 TryJPEG2000Codec()

```
bool gdcm::ImageChangeTransferSyntax::TryJPEG2000Codec (
    const DataElement & pixelde,
    Bitmap const & input,
    Bitmap & output ) [protected]
```

### 10.148.3.8 TryJPEGCodec()

```
bool gdcm::ImageChangeTransferSyntax::TryJPEGCodec (
    const DataElement & pixelde,
    Bitmap const & input,
    Bitmap & output ) [protected]
```

### 10.148.3.9 TryJPEGLSCodec()

```
bool gdcm::ImageChangeTransferSyntax::TryJPEGLSCodec (
    const DataElement & pixelde,
    Bitmap const & input,
    Bitmap & output ) [protected]
```

### 10.148.3.10 TryRAWCodec()

```
bool gdcm::ImageChangeTransferSyntax::TryRAWCodec (
    const DataElement & pixelde,
    Bitmap const & input,
    Bitmap & output ) [protected]
```

### 10.148.3.11 TryRLECodec()

```
bool gdcm::ImageChangeTransferSyntax::TryRLECodec (
    const DataElement & pixelde,
    Bitmap const & input,
    Bitmap & output ) [protected]
```

The documentation for this class was generated from the following file:

- [gdcmImageChangeTransferSyntax.h](#)

## 10.149 gdcm::ImageCodec Class Reference

[ImageCodec](#).

```
#include <gdcmImageCodec.h>
```

Inheritance diagram for `gdcm::ImageCodec`:

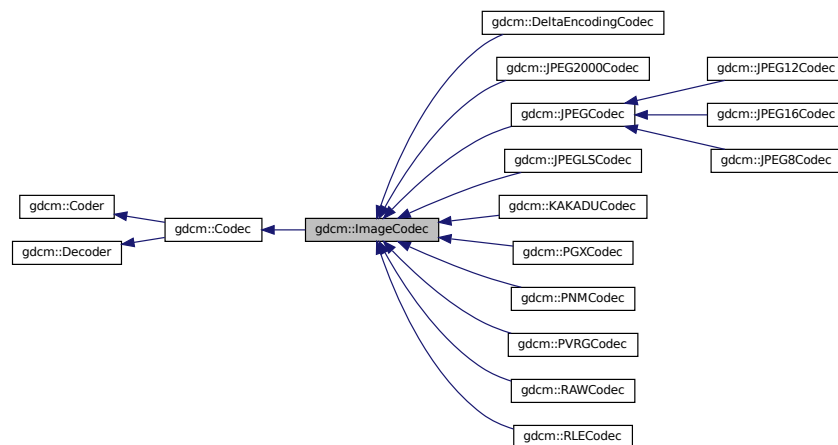



Collaboration diagram for gdcm::ImageCodec:

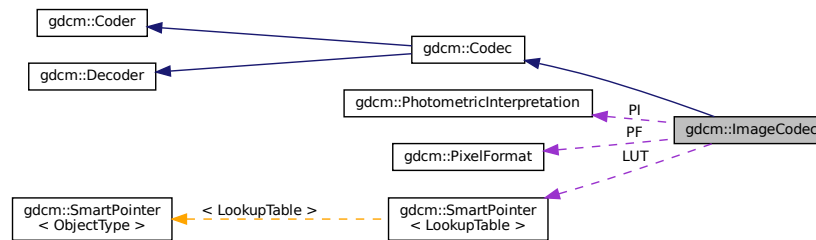

## Public Member Functions

- [ImageCodec](#) ()
- [~ImageCodec](#) () override
- bool [CanCode](#) ([TransferSyntax](#) const &) const override  
*Return whether this coder support this transfer syntax (can code it)*
- bool [CanDecode](#) ([TransferSyntax](#) const &) const override  
*Return whether this decoder support this transfer syntax (can decode it)*
- bool [CleanupUnusedBits](#) (char \*data, size\_t datalen)
- virtual [ImageCodec](#) \* [Clone](#) () const =0
- bool [Decode](#) ([DataElement](#) const &is\_, [DataElement](#) &os) override  
*Decode.*
- const unsigned int \* [GetDimensions](#) () const
- virtual bool [GetHeaderInfo](#) (std::istream &is\_, [TransferSyntax](#) &ts)
- bool [GetLossyFlag](#) () const
- const [LookupTable](#) & [GetLUT](#) () const
- bool [GetNeedByteSwap](#) () const
- unsigned int [GetNumberOfDimensions](#) () const
- const [PhotometricInterpretation](#) & [GetPhotometricInterpretation](#) () const
- [PixelFormat](#) & [GetPixelFormat](#) ()
- const [PixelFormat](#) & [GetPixelFormat](#) () const
- unsigned int [GetPlanarConfiguration](#) () const
- bool [IsLossy](#) () const
- void [SetDimensions](#) (const std::vector< unsigned int > &d)
- void [SetDimensions](#) (const unsigned int d[3])
- void [SetLossyFlag](#) (bool l)
- void [SetLUT](#) ([LookupTable](#) const &lut)
- void [SetNeedByteSwap](#) (bool b)
- void [SetNeedOverlayCleanup](#) (bool b)
- void [SetNumberOfDimensions](#) (unsigned int dim)
- void [SetPhotometricInterpretation](#) ([PhotometricInterpretation](#) const &pi)
- virtual void [SetPixelFormat](#) ([PixelFormat](#) const &pf)
- void [SetPlanarConfiguration](#) (unsigned int pc)

## Protected Types

- typedef [SmartPointer](#)< [LookupTable](#) > [LUTPtr](#)

## Protected Member Functions

- virtual bool [AppendFrameEncode](#) (std::ostream &out, const char \*data, size\_t datalen)
- virtual bool [AppendRowEncode](#) (std::ostream &out, const char \*data, size\_t datalen)
- bool [DecodeByStreams](#) (std::istream &is\_, std::ostream &os) override
- bool [DoByteSwap](#) (std::istream &is\_, std::ostream &os)
- bool [DoInvertMonochrome](#) (std::istream &is\_, std::ostream &os)
- bool [DoOverlayCleanup](#) (std::istream &is\_, std::ostream &os)
- bool [DoPaddedCompositePixelCode](#) (std::istream &is\_, std::ostream &os)
- bool [DoPlanarConfiguration](#) (std::istream &is\_, std::ostream &os)
- bool [DoSimpleCopy](#) (std::istream &is\_, std::ostream &os)
- bool [DoYBR](#) (std::istream &is\_, std::ostream &os)
- bool [DoYBRFull422](#) (std::istream &is\_, std::ostream &os)
- virtual bool [IsFrameEncoder](#) ()
- virtual bool [IsRowEncoder](#) ()
- virtual bool [IsValid](#) ([PhotometricInterpretation](#) const &pi)
- virtual bool [StartEncode](#) (std::ostream &os)
- virtual bool [StopEncode](#) (std::ostream &os)

## Protected Attributes

- unsigned int [Dimensions](#) [3]
- bool [LossyFlag](#)
- [LUTPtr](#) [LUT](#)
- bool [NeedByteSwap](#)
- bool [NeedOverlayCleanup](#)
- unsigned int [NumberOfDimensions](#)
- [PixelFormat](#) [PF](#)
- [PhotometricInterpretation](#) [PI](#)
- unsigned int [PlanarConfiguration](#)
- bool [RequestPaddedCompositePixelCode](#)
- bool [RequestPlanarConfiguration](#)

## Friends

- class [FileChangeTransferSyntax](#)
- class [ImageChangePhotometricInterpretation](#)

## 10.149.1 Detailed Description

[ImageCodec](#).

### Note

Main codec, this is a central place for all implementation

## 10.149.2 Member Typedef Documentation

### 10.149.2.1 LUTPtr

```
typedef SmartPointer<LookupTable> gdcM::ImageCodec::LUTPtr [protected]
```

## 10.149.3 Constructor & Destructor Documentation

### 10.149.3.1 ImageCodec()

```
gdcM::ImageCodec::ImageCodec ( )
```

### 10.149.3.2 ~ImageCodec()

```
gdcM::ImageCodec::~~ImageCodec ( ) [override]
```

## 10.149.4 Member Function Documentation

### 10.149.4.1 AppendFrameEncode()

```
virtual bool gdcM::ImageCodec::AppendFrameEncode (
    std::ostream & out,
    const char * data,
    size_t dataLen ) [protected], [virtual]
```

Reimplemented in [gdcM::RLECodec](#), [gdcM::JPEGLSCodec](#), [gdcM::JPEGCodec](#), and [gdcM::JPEG2000Codec](#).

#### 10.149.4.2 AppendRowEncode()

```
virtual bool gdcM::ImageCodec::AppendRowEncode (
    std::ostream & out,
    const char * data,
    size_t datalen ) [protected], [virtual]
```

Reimplemented in [gdcM::RLECodec](#), [gdcM::JPEGLSCodec](#), [gdcM::JPEGCodec](#), and [gdcM::JPEG2000Codec](#).

#### 10.149.4.3 CanCode()

```
bool gdcM::ImageCodec::CanCode (
    TransferSyntax const & ) const [inline], [override], [virtual]
```

Return whether this coder support this transfer syntax (can code it)

Implements [gdcM::Coder](#).

Reimplemented in [gdcM::RLECodec](#), [gdcM::RAWCodec](#), [gdcM::PVRGCodec](#), [gdcM::PNMCodec](#), [gdcM::PGXCodec](#), [gdcM::KAKADUCodec](#), [gdcM::JPEGLSCodec](#), [gdcM::JPEGCodec](#), and [gdcM::JPEG2000Codec](#).

#### 10.149.4.4 CanDecode()

```
bool gdcM::ImageCodec::CanDecode (
    TransferSyntax const & ) const [inline], [override], [virtual]
```

Return whether this decoder support this transfer syntax (can decode it)

Implements [gdcM::Decoder](#).

Reimplemented in [gdcM::RLECodec](#), [gdcM::RAWCodec](#), [gdcM::PVRGCodec](#), [gdcM::PNMCodec](#), [gdcM::PGXCodec](#), [gdcM::KAKADUCodec](#), [gdcM::JPEGLSCodec](#), [gdcM::JPEGCodec](#), and [gdcM::JPEG2000Codec](#).

#### 10.149.4.5 CleanupUnusedBits()

```
bool gdcM::ImageCodec::CleanupUnusedBits (
    char * data,
    size_t datalen )
```

#### 10.149.4.6 Clone()

```
virtual ImageCodec* gdcm::ImageCodec::Clone ( ) const [pure virtual]
```

Implemented in [gdcm::RLECodec](#), [gdcm::RAWCodec](#), [gdcm::PVRGCodec](#), [gdcm::PNMCodec](#), [gdcm::PGXCodec](#), [gdcm::KAKADUCodec](#), [gdcm::JPEGLSCodec](#), [gdcm::JPEGCodec](#), and [gdcm::JPEG2000Codec](#).

#### 10.149.4.7 Decode()

```
bool gdcm::ImageCodec::Decode (
    DataElement const & ,
    DataElement & ) [override], [virtual]
```

Decode.

Reimplemented from [gdcm::Decoder](#).

Reimplemented in [gdcm::RLECodec](#), [gdcm::RAWCodec](#), [gdcm::PVRGCodec](#), [gdcm::KAKADUCodec](#), [gdcm::JPEGLSCodec](#), [gdcm::JPEGCodec](#), and [gdcm::JPEG2000Codec](#).

#### 10.149.4.8 DecodeByStreams()

```
bool gdcm::ImageCodec::DecodeByStreams (
    std::istream & is_,
    std::ostream & os ) [override], [protected], [virtual]
```

Reimplemented from [gdcm::Decoder](#).

Reimplemented in [gdcm::RLECodec](#), [gdcm::RAWCodec](#), [gdcm::JPEGCodec](#), [gdcm::JPEG8Codec](#), [gdcm::JPEG2000Codec](#), [gdcm::JPEG16Codec](#), and [gdcm::JPEG12Codec](#).

#### 10.149.4.9 DoByteSwap()

```
bool gdcm::ImageCodec::DoByteSwap (
    std::istream & is_,
    std::ostream & os ) [protected]
```

**10.149.4.10 DoInvertMonochrome()**

```
bool gdcM::ImageCodec::DoInvertMonochrome (
    std::istream & is_,
    std::ostream & os ) [protected]
```

**10.149.4.11 DoOverlayCleanup()**

```
bool gdcM::ImageCodec::DoOverlayCleanup (
    std::istream & is_,
    std::ostream & os ) [protected]
```

**10.149.4.12 DoPaddedCompositePixelCode()**

```
bool gdcM::ImageCodec::DoPaddedCompositePixelCode (
    std::istream & is_,
    std::ostream & os ) [protected]
```

**10.149.4.13 DoPlanarConfiguration()**

```
bool gdcM::ImageCodec::DoPlanarConfiguration (
    std::istream & is_,
    std::ostream & os ) [protected]
```

**10.149.4.14 DoSimpleCopy()**

```
bool gdcM::ImageCodec::DoSimpleCopy (
    std::istream & is_,
    std::ostream & os ) [protected]
```

**10.149.4.15 DoYBR()**

```
bool gdcM::ImageCodec::DoYBR (
    std::istream & is_,
    std::ostream & os ) [protected]
```

#### 10.149.4.16 DoYBRFull422()

```
bool gdcm::ImageCodec::DoYBRFull422 (
    std::istream & is_,
    std::ostream & os ) [protected]
```

#### 10.149.4.17 GetDimensions()

```
const unsigned int* gdcm::ImageCodec::GetDimensions ( ) const [inline]
```

#### 10.149.4.18 GetHeaderInfo()

```
virtual bool gdcm::ImageCodec::GetHeaderInfo (
    std::istream & is_,
    TransferSyntax & ts ) [virtual]
```

Reimplemented in [gdcm::RLECodec](#), [gdcm::RAWCodec](#), [gdcm::PNMCodec](#), [gdcm::PGXCodec](#), [gdcm::JPEGLSCodec](#), [gdcm::JPEGCodec](#), [gdcm::JPEG8Codec](#), [gdcm::JPEG2000Codec](#), [gdcm::JPEG16Codec](#), and [gdcm::JPEG12Codec](#).

#### 10.149.4.19 GetLossyFlag()

```
bool gdcm::ImageCodec::GetLossyFlag ( ) const
```

#### 10.149.4.20 GetLUT()

```
const LookupTable& gdcm::ImageCodec::GetLUT ( ) const [inline]
```

#### 10.149.4.21 GetNeedByteSwap()

```
bool gdcm::ImageCodec::GetNeedByteSwap ( ) const [inline]
```

#### 10.149.4.22 GetNumberOfDimensions()

```
unsigned int gdcM::ImageCodec::GetNumberOfDimensions ( ) const
```

#### 10.149.4.23 GetPhotometricInterpretation()

```
const PhotometricInterpretation& gdcM::ImageCodec::GetPhotometricInterpretation ( ) const
```

#### 10.149.4.24 GetPixelFormat() [1/2]

```
PixelFormat& gdcM::ImageCodec::GetPixelFormat ( ) [inline]
```

#### Examples

[GetJPEGSamplePrecision.cxx](#).

#### 10.149.4.25 GetPixelFormat() [2/2]

```
const PixelFormat& gdcM::ImageCodec::GetPixelFormat ( ) const [inline]
```

#### 10.149.4.26 GetPlanarConfiguration()

```
unsigned int gdcM::ImageCodec::GetPlanarConfiguration ( ) const [inline]
```

#### 10.149.4.27 IsFrameEncoder()

```
virtual bool gdcM::ImageCodec::IsFrameEncoder ( ) [protected], [virtual]
```

Reimplemented in [gdcM::RLECodec](#), [gdcM::JPEGLSCodec](#), [gdcM::JPEGCodec](#), and [gdcM::JPEG2000Codec](#).



#### 10.149.4.28 IsLossy()

```
bool gdcm::ImageCodec::IsLossy ( ) const
```

#### 10.149.4.29 IsRowEncoder()

```
virtual bool gdcm::ImageCodec::IsRowEncoder ( ) [protected], [virtual]
```

Reimplemented in [gdcm::RLECodec](#), [gdcm::JPEGLSCodec](#), [gdcm::JPEGCodec](#), and [gdcm::JPEG2000Codec](#).

#### 10.149.4.30 IsValid()

```
virtual bool gdcm::ImageCodec::IsValid (
    PhotometricInterpretation const & pi ) [protected], [virtual]
```

Reimplemented in [gdcm::JPEGCodec](#).

#### 10.149.4.31 SetDimensions() [1/2]

```
void gdcm::ImageCodec::SetDimensions (
    const std::vector< unsigned int > & d )
```

#### 10.149.4.32 SetDimensions() [2/2]

```
void gdcm::ImageCodec::SetDimensions (
    const unsigned int d[3] )
```

#### Examples

[ExtractIconFromFile.cxx](#).

**10.149.4.33 SetLossyFlag()**

```
void gdcM::ImageCodec::SetLossyFlag (
    bool l )
```

**10.149.4.34 SetLUT()**

```
void gdcM::ImageCodec::SetLUT (
    LookupTable const & lut ) [inline]
```

**Examples**

[ExtractIconFromFile.cxx](#).

**10.149.4.35 SetNeedByteSwap()**

```
void gdcM::ImageCodec::SetNeedByteSwap (
    bool b ) [inline]
```

**10.149.4.36 SetNeedOverlayCleanup()**

```
void gdcM::ImageCodec::SetNeedOverlayCleanup (
    bool b ) [inline]
```

**10.149.4.37 SetNumberOfDimensions()**

```
void gdcM::ImageCodec::SetNumberOfDimensions (
    unsigned int dim )
```

#### 10.149.4.38 SetPhotometricInterpretation()

```
void gdcM::ImageCodec::SetPhotometricInterpretation (
    PhotometricInterpretation const & pi )
```

##### Examples

[ExtractIconFromFile.cxx](#).

#### 10.149.4.39 SetPixelFormat()

```
virtual void gdcM::ImageCodec::SetPixelFormat (
    PixelFormat const & pf ) [inline], [virtual]
```

Reimplemented in [gdcM::JPEGCodec](#).

##### Examples

[ExtractIconFromFile.cxx](#).

#### 10.149.4.40 SetPlanarConfiguration()

```
void gdcM::ImageCodec::SetPlanarConfiguration (
    unsigned int pc ) [inline]
```

#### 10.149.4.41 StartEncode()

```
virtual bool gdcM::ImageCodec::StartEncode (
    std::ostream & os ) [protected], [virtual]
```

Reimplemented in [gdcM::RLECodec](#), [gdcM::JPEGLSCodec](#), [gdcM::JPEGCodec](#), and [gdcM::JPEG2000Codec](#).

#### 10.149.4.42 StopEncode()

```
virtual bool gdcM::ImageCodec::StopEncode (
    std::ostream & os ) [protected], [virtual]
```

Reimplemented in [gdcM::RLECodec](#), [gdcM::JPEGLSCodec](#), [gdcM::JPEGCodec](#), and [gdcM::JPEG2000Codec](#).

## 10.149.5 Friends And Related Function Documentation

### 10.149.5.1 FileChangeTransferSyntax

```
friend class FileChangeTransferSyntax [friend]
```

This is a high level API to encode in a streaming fashion. Each plugin will handle differently the caching mechanism so that a limited memory is used when compressing dataset. [Codec](#) will fall into two categories:

- Full row encoder: only a single scanline (row) of data is needed to be loaded at a time;
- Full frame encoder (default): a complete frame (row x col) is needed to be loaded at a time

### 10.149.5.2 ImageChangePhotometricInterpretation

```
friend class ImageChangePhotometricInterpretation [friend]
```

## 10.149.6 Member Data Documentation

### 10.149.6.1 Dimensions

```
unsigned int gdcm::ImageCodec::Dimensions[3] [protected]
```

### 10.149.6.2 LossyFlag

```
bool gdcm::ImageCodec::LossyFlag [protected]
```

### 10.149.6.3 LUT

```
LUTPtr gdcm::ImageCodec::LUT [protected]
```

#### 10.149.6.4 NeedByteSwap

`bool gdcm::ImageCodec::NeedByteSwap [protected]`

#### 10.149.6.5 NeedOverlayCleanup

`bool gdcm::ImageCodec::NeedOverlayCleanup [protected]`

#### 10.149.6.6 NumberOfDimensions

`unsigned int gdcm::ImageCodec::NumberOfDimensions [protected]`

#### 10.149.6.7 PF

`PixelFormat gdcm::ImageCodec::PF [protected]`

#### 10.149.6.8 PI

`PhotometricInterpretation gdcm::ImageCodec::PI [protected]`

#### 10.149.6.9 PlanarConfiguration

`unsigned int gdcm::ImageCodec::PlanarConfiguration [protected]`

#### 10.149.6.10 RequestPaddedCompositePixelCode

`bool gdcm::ImageCodec::RequestPaddedCompositePixelCode [protected]`

### 10.149.6.11 RequestPlanarConfiguration

```
bool gdcM::ImageCodec::RequestPlanarConfiguration [protected]
```

The documentation for this class was generated from the following file:

- [gdcMImageCodec.h](#)

## 10.150 gdcM::ImageConverter Class Reference

[Image](#) Converter.

```
#include <gdcMImageConverter.h>
```

### Public Member Functions

- [ImageConverter](#) ()
- [~ImageConverter](#) ()
- void [Convert](#) ()
- const [Image](#) & [GetOutput](#) () const
- void [SetInput](#) ([Image](#) const &input)

### 10.150.1 Detailed Description

[Image](#) Converter.

#### Note

This is the class used to convert from on [Image](#) to another This is typically used to convert let say YBR JPEG compressed [Image](#) to a RAW RGB [Image](#). So that the buffer can be directly pass to third party application. This filter is application level and not integrated directly in GDCM

### 10.150.2 Constructor & Destructor Documentation

#### 10.150.2.1 ImageConverter()

```
gdcM::ImageConverter::ImageConverter ( )
```

### 10.150.2.2 ~ImageConverter()

```
gdcM::ImageConverter::~ImageConverter ( )
```

## 10.150.3 Member Function Documentation

### 10.150.3.1 Convert()

```
void gdcM::ImageConverter::Convert ( )
```

### 10.150.3.2 GetOutput()

```
const Image& gdcM::ImageConverter::GetOutput ( ) const
```

### 10.150.3.3 SetInput()

```
void gdcM::ImageConverter::SetInput (   
    Image const & input )
```

The documentation for this class was generated from the following file:

- [gdcMImageConverter.h](#)

## 10.151 gdcm::ImageFragmentSplitter Class Reference

[ImageFragmentSplitter](#) class.

```
#include <gdcmImageFragmentSplitter.h>
```

Inheritance diagram for gdcm::ImageFragmentSplitter:

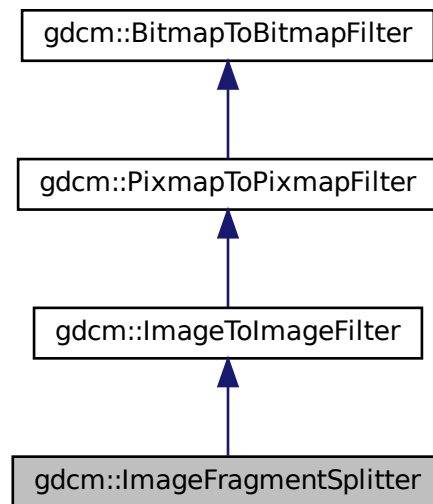



Collaboration diagram for gdcm::ImageFragmentSplitter:

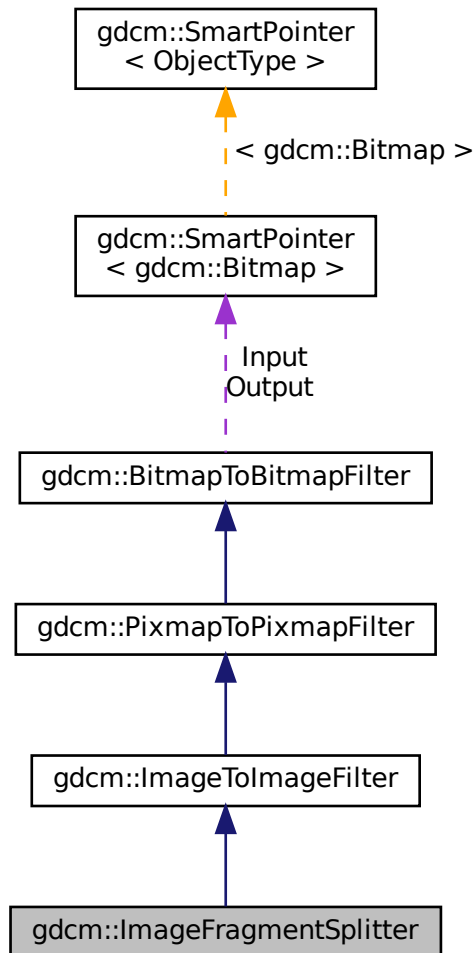

## Public Member Functions

- `ImageFragmentSplitter ()`
- `~ImageFragmentSplitter ()=default`
- unsigned int `GetFragmentSizeMax () const`
- void `SetForce (bool f)`
- void `SetFragmentSizeMax (unsigned int fragsize)`  
*FragmentSizeMax needs to be an even number.*
- bool `Split ()`  
*Split.*

## Additional Inherited Members

### 10.151.1 Detailed Description

[ImageFragmentSplitter](#) class.

For single frame image, DICOM standard allow splitting the frame into multiple fragments

### 10.151.2 Constructor & Destructor Documentation

#### 10.151.2.1 ImageFragmentSplitter()

```
gdcM::ImageFragmentSplitter::ImageFragmentSplitter ( ) [inline]
```

#### 10.151.2.2 ~ImageFragmentSplitter()

```
gdcM::ImageFragmentSplitter::~~ImageFragmentSplitter ( ) [default]
```

### 10.151.3 Member Function Documentation

#### 10.151.3.1 GetFragmentSizeMax()

```
unsigned int gdcM::ImageFragmentSplitter::GetFragmentSizeMax ( ) const [inline]
```

#### 10.151.3.2 SetForce()

```
void gdcM::ImageFragmentSplitter::SetForce (
    bool f ) [inline]
```

When file already has all it's segment < FragmentSizeMax there is not need to run the filter. Unless the user explicitly say 'force' recomputation !

### 10.151.3.3 SetFragmentSizeMax()

```
void gdcm::ImageFragmentSplitter::SetFragmentSizeMax (
    unsigned int fragsize )
```

FragmentSizeMax needs to be an even number.

### 10.151.3.4 Split()

```
bool gdcm::ImageFragmentSplitter::Split ( )
```

Split.

The documentation for this class was generated from the following file:

- [gdcmImageFragmentSplitter.h](#)

## 10.152 gdcm::ImageHelper Class Reference

[ImageHelper](#) (internal class, not intended for user level)

```
#include <gdcmImageHelper.h>
```

### Static Public Member Functions

- static [MediaStorage](#) [ComputeMediaStorageFromModality](#) (const char \*modality, unsigned int dimension=2, [PixelFormat](#) const &pf=[PixelFormat](#)(), [PhotometricInterpretation](#) const &pi=[PhotometricInterpretation](#)()), double rescaleintercept=0, double rescaleslope=1)
 

*Moved from [MediaStorage](#) here, since we need extra info stored in [PixelFormat](#) & [PhotometricInterpretation](#).*
- static bool [ComputeSpacingFromImagePositionPatient](#) (const std::vector< double > &imageposition, std::vector< double > &spacing)
 

*DO NOT USE.*
- static std::vector< unsigned int > [GetDimensionsValue](#) (const [File](#) &f)
- static bool [GetDirectionCosinesFromDataSet](#) ([DataSet](#) const &ds, std::vector< double > &dircos)
- static std::vector< double > [GetDirectionCosinesValue](#) ([File](#) const &f)
- static bool [GetForcePixelSpacing](#) ()
- static bool [GetForceRescaleInterceptSlope](#) ()
- static [SmartPointer](#)< [LookupTable](#) > [GetLUT](#) ([File](#) const &f)
 

*returns the lookup table of an image file*
- static std::vector< double > [GetOriginValue](#) ([File](#) const &f)
 

*Set/Get Origin (IPP) from/to a file.*
- static [PhotometricInterpretation](#) [GetPhotometricInterpretationValue](#) ([File](#) const &f)
- static [PixelFormat](#) [GetPixelFormatValue](#) (const [File](#) &f)
- static unsigned int [GetPlanarConfigurationValue](#) (const [File](#) &f)

- static bool [GetPMSRescaleInterceptSlope](#) ()
- static const [ByteValue](#) \* [GetPointerFromElement](#) ([Tag](#) const &tag, [File](#) const &f)
- static bool [GetRealWorldValueMappingContent](#) ([File](#) const &f, [RealWorldValueMappingContent](#) &rwvmc)
- static std::vector< double > [GetRescaleInterceptSlopeValue](#) ([File](#) const &f)
- static std::vector< double > [GetSpacingValue](#) ([File](#) const &f)
  - Set/Get [Spacing](#) from/to a [File](#).*
- static void [SetDimensionsValue](#) ([File](#) &f, const [Pixmap](#) &img)
- static void [SetDirectionCosinesValue](#) ([DataSet](#) &ds, const std::vector< double > &dircos)
- static void [SetForcePixelSpacing](#) (bool)
- static void [SetForceRescaleInterceptSlope](#) (bool)
- static void [SetOriginValue](#) ([DataSet](#) &ds, const [Image](#) &img)
- static void [SetPMSRescaleInterceptSlope](#) (bool)
- static void [SetRescaleInterceptSlopeValue](#) ([File](#) &f, const [Image](#) &img)
- static void [SetSpacingValue](#) ([DataSet](#) &ds, const std::vector< double > &spacing)

## Static Protected Member Functions

- static [Tag](#) [GetSpacingTagFromMediaStorage](#) ([MediaStorage](#) const &ms)
- static [Tag](#) [GetZSpacingTagFromMediaStorage](#) ([MediaStorage](#) const &ms)

### 10.152.1 Detailed Description

[ImageHelper](#) (internal class, not intended for user level)

Helper for writing World images in DICOM. DICOM has a 'template' approach to image where MR [Image](#) Storage are distinct object from Enhanced MR [Image](#) Storage. For example the Pixel [Spacing](#) in one object is not at the same position (ie [Tag](#)) as in the other this class is the central (read: fragile) place where all the dispatching is done from a unified view of a world image (typically VTK or ITK point of view) down to the low level DICOM point of view.

#### Warning

: do not expect the API of this class to be maintained at any point, since as Modalities are added the API might have to be augmented or behavior changed to cope with new modalities.

### 10.152.2 Member Function Documentation

#### 10.152.2.1 ComputeMediaStorageFromModality()

```
static MediaStorage gdcM::ImageHelper::ComputeMediaStorageFromModality (
    const char * modality,
    unsigned int dimension = 2,
    PixelFormat const & pf = PixelFormat (),
    PhotometricInterpretation const & pi = PhotometricInterpretation (),
    double rescaleintercept = 0,
    double rescaleslope = 1 ) [static]
```

Moved from [MediaStorage](#) here, since we need extra info stored in [PixelFormat](#) & [PhotometricInterpretation](#).

### 10.152.2.2 ComputeSpacingFromImagePositionPatient()

```
static bool gdcm::ImageHelper::ComputeSpacingFromImagePositionPatient (
    const std::vector< double > & imageposition,
    std::vector< double > & spacing ) [static]
```

DO NOT USE.

### 10.152.2.3 GetDimensionsValue()

```
static std::vector<unsigned int> gdcm::ImageHelper::GetDimensionsValue (
    const File & f ) [static]
```

This function checks tags (0x0028, 0x0010) and (0x0028, 0x0011) for the rows and columns of the image in pixels (as opposed to actual distances). The output is {col , row}

#### Examples

[Extracting\\_All\\_Resolution.cxx](#), [Fake\\_Image\\_Using\\_Stream\\_Image\\_Writer.cxx](#), and [StreamImageReaderTest.cxx](#).

### 10.152.2.4 GetDirectionCosinesFromDataSet()

```
static bool gdcm::ImageHelper::GetDirectionCosinesFromDataSet (
    DataSet const & ds,
    std::vector< double > & dircos ) [static]
```

### 10.152.2.5 GetDirectionCosinesValue()

```
static std::vector<double> gdcm::ImageHelper::GetDirectionCosinesValue (
    File const & f ) [static]
```

Get Direction Cosines (IOP) from/to a file Requires a file because mediastorage must be known

### 10.152.2.6 GetForcePixelSpacing()

```
static bool gdcm::ImageHelper::GetForcePixelSpacing ( ) [static]
```

### 10.152.2.7 GetForceRescaleInterceptSlope()

```
static bool gdcM::ImageHelper::GetForceRescaleInterceptSlope ( ) [static]
```

### 10.152.2.8 GetLUT()

```
static SmartPointer<LookupTable> gdcM::ImageHelper::GetLUT (
    File const & f ) [static]
```

returns the lookup table of an image file

### 10.152.2.9 GetOriginValue()

```
static std::vector<double> gdcM::ImageHelper::GetOriginValue (
    File const & f ) [static]
```

Set/Get Origin (IPP) from/to a file.

### 10.152.2.10 GetPhotometricInterpretationValue()

```
static PhotometricInterpretation gdcM::ImageHelper::GetPhotometricInterpretationValue (
    File const & f ) [static]
```

### 10.152.2.11 GetPixelFormatValue()

```
static PixelFormat gdcM::ImageHelper::GetPixelFormatValue (
    const File & f ) [static]
```

This function returns pixel information about an image from its dataset That includes samples per pixel and bit depth (in that order)

### 10.152.2.12 GetPlanarConfigurationValue()

```
static unsigned int gdcM::ImageHelper::GetPlanarConfigurationValue (
    const File & f ) [static]
```

### 10.152.2.13 GetPMSRescaleInterceptSlope()

```
static bool gdcm::ImageHelper::GetPMSRescaleInterceptSlope ( ) [static]
```

### 10.152.2.14 GetPointerFromElement()

```
static const ByteValue* gdcm::ImageHelper::GetPointerFromElement (
    Tag const & tag,
    File const & f ) [static]
```

### 10.152.2.15 GetRealWorldValueMappingContent()

```
static bool gdcm::ImageHelper::GetRealWorldValueMappingContent (
    File const & f,
    RealWorldValueMappingContent & rwvmc ) [static]
```

### 10.152.2.16 GetRescaleInterceptSlopeValue()

```
static std::vector<double> gdcm::ImageHelper::GetRescaleInterceptSlopeValue (
    File const & f ) [static]
```

Set/Get shift/scale from/to a file

#### Warning

this function reads/sets the Slope/Intercept in appropriate class storage, but also Grid Scaling in RT Dose Storage  
Can't take a dataset because the mediastorage of the file must be known

### 10.152.2.17 GetSpacingTagFromMediaStorage()

```
static Tag gdcm::ImageHelper::GetSpacingTagFromMediaStorage (
    MediaStorage const & ms ) [static], [protected]
```

### 10.152.2.18 GetSpacingValue()

```
static std::vector<double> gdcM::ImageHelper::GetSpacingValue (
    File const & f ) [static]
```

Set/Get [Spacing](#) from/to a [File](#).

### 10.152.2.19 GetZSpacingTagFromMediaStorage()

```
static Tag gdcM::ImageHelper::GetZSpacingTagFromMediaStorage (
    MediaStorage const & ms ) [static], [protected]
```

### 10.152.2.20 SetDimensionsValue()

```
static void gdcM::ImageHelper::SetDimensionsValue (
    File & f,
    const Pixmap & img ) [static]
```

### 10.152.2.21 SetDirectionCosinesValue()

```
static void gdcM::ImageHelper::SetDirectionCosinesValue (
    DataSet & ds,
    const std::vector< double > & dircos ) [static]
```

Set Direction Cosines (IOP) from/to a file When [IOD](#) does not defines what is IOP (eg. typically [Secondary Capture Image Storage](#)) this call will simply remove the IOP attribute. Else in case of MR/CT image storage, this call will properly lookup the correct attribute to store the IOP.

### 10.152.2.22 SetForcePixelSpacing()

```
static void gdcM::ImageHelper::SetForcePixelSpacing (
    bool ) [static]
```

GDCM 1.x compatibility issue: When using [ReWrite](#) an MR [Image Storage](#) would be rewritten as [Secondary Capture Object](#) while still having a [Pixel Spacing](#) tag (0028,0030). If you have deal with those files, use this very special flag to handle them Unless explicitly set elsewhere by the standard, it will use value from 0028,0030 / 0018,0088 for the [Pixel Spacing](#) of the [Image](#)



### 10.152.2.23 SetForceRescaleInterceptSlope()

```
static void gdcM::ImageHelper::SetForceRescaleInterceptSlope (
    bool ) [static]
```

GDCM 1.x compatibility issue: Do not use anymore. This hack was used for some MR [Image](#) Storage generated by Philips Modality. When "Combine MR Rescaling" is set to TRUE, rescaling is removed. But when set to FALSE, the Modality LUT was exported. Internally GDCM now handles this gracefully.

### 10.152.2.24 SetOriginValue()

```
static void gdcM::ImageHelper::SetOriginValue (
    DataSet & ds,
    const Image & img ) [static]
```

### 10.152.2.25 SetPMSRescaleInterceptSlope()

```
static void gdcM::ImageHelper::SetPMSRescaleInterceptSlope (
    bool ) [static]
```

Since GDCM 2.6.1 Philips Medical [System](#) are read using the Private Field For Rescale Slope/Intercept by default. This mechanism can be deactivated using the following API: This option has no effect when ForceRescaleInterceptSlope is set to true GDCM will only read those private attribute but never write them out.

### 10.152.2.26 SetRescaleInterceptSlopeValue()

```
static void gdcM::ImageHelper::SetRescaleInterceptSlopeValue (
    File & f,
    const Image & img ) [static]
```

### 10.152.2.27 SetSpacingValue()

```
static void gdcM::ImageHelper::SetSpacingValue (
    DataSet & ds,
    const std::vector< double > & spacing ) [static]
```

The documentation for this class was generated from the following file:

- [gdcMImageHelper.h](#)

## 10.153 gdcm::ImageReader Class Reference

[ImageReader](#).

```
#include <gdcmImageReader.h>
```

Inheritance diagram for gdcm::ImageReader:

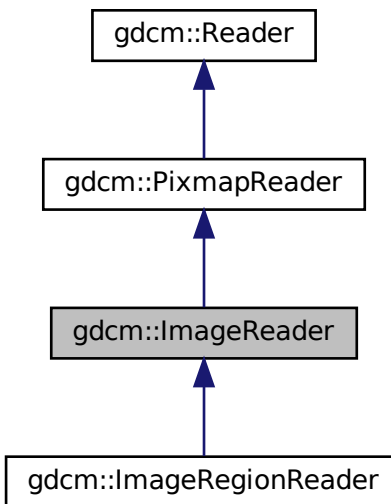

Collaboration diagram for gdcm::ImageReader:

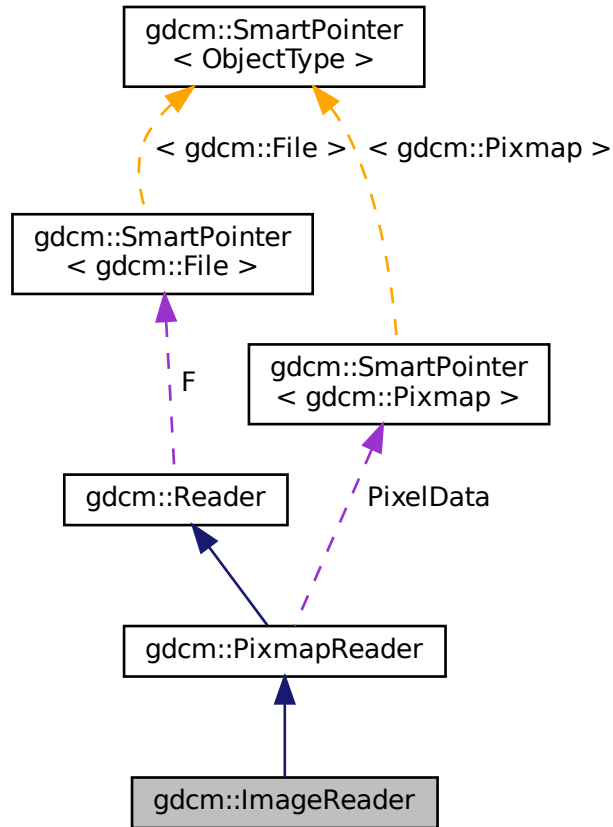

## Public Member Functions

- [ImageReader](#) ()
- [~ImageReader](#) () override
- [Image](#) & [GetImage](#) ()
- const [Image](#) & [GetImage](#) () const  
*Return the read image.*
- bool [Read](#) () override

## Protected Member Functions

- bool [ReadACRNEMAIImage](#) () override
- bool [ReadImage](#) ([MediaStorage](#) const &ms) override

## Additional Inherited Members

### 10.153.1 Detailed Description

[ImageReader](#).

#### Note

its role is to convert the DICOM [DataSet](#) into a [Image](#) representation [Image](#) is different from [Pixmap](#) has it has a position and a direction in Space.

#### See also

[Image](#)

#### Examples

[CheckBigEndianBug.cxx](#), [CompressImage.cxx](#), [ConvertToQImage.cxx](#), [ExtractIconFromFile.cxx](#), [FixBrokenJ2K.cxx](#), [FixJAIBugJPEGs.cxx](#), [GetJPEGSamplePrecision.cxx](#), [HelloVizWorld.cxx](#), [MergeTwoFiles.cxx](#), [MrProtocol.cxx](#), [PatchFile.cxx](#), [PrintLUT.cxx](#), [ReadMultiTimesException.cxx](#), and [threadgdc.cxx](#).

### 10.153.2 Constructor & Destructor Documentation

#### 10.153.2.1 ImageReader()

```
gdc::ImageReader::ImageReader ( )
```

#### 10.153.2.2 ~ImageReader()

```
gdc::ImageReader::~ImageReader ( ) [override]
```

### 10.153.3 Member Function Documentation

#### 10.153.3.1 GetImage() [1/2]

```
Image& gdc::ImageReader::GetImage ( )
```

### 10.153.3.2 GetImage() [2/2]

```
const Image& gdcm::ImageReader::GetImage ( ) const
```

Return the read image.

#### Examples

[CompressImage.cxx](#), [ConvertToQImage.cxx](#), [ExtractIconFromFile.cxx](#), [FixJAIBugJPEGLS.cxx](#), [GetJPEGSamplePrecision.cxx](#), [HelloVizWorld.cxx](#), [MergeTwoFiles.cxx](#), [PatchFile.cxx](#), [PrintLUT.cxx](#), [ReadMultiTimesException.cxx](#), [TemplateEmptyImage.cxx](#), and [threadgdcm.cxx](#).

### 10.153.3.3 Read()

```
bool gdcm::ImageReader::Read ( ) [override], [virtual]
```

Read the DICOM image. There are two reason for failure:

1. The input filename is not DICOM
2. The input DICOM file does not contains an [Image](#).

Reimplemented from [gdcm::Reader](#).

Reimplemented in [gdcm::ImageRegionReader](#).

#### Examples

[CheckBigEndianBug.cxx](#), [CompressImage.cxx](#), [ConvertToQImage.cxx](#), [ExtractIconFromFile.cxx](#), [FixBrokenJ2K.cxx](#), [FixJAIBugJPEGLS.cxx](#), [GetJPEGSamplePrecision.cxx](#), [HelloVizWorld.cxx](#), [MergeTwoFiles.cxx](#), [MrProtocol.cxx](#), [PatchFile.cxx](#), [PrintLUT.cxx](#), [ReadMultiTimesException.cxx](#), and [threadgdcm.cxx](#).

### 10.153.3.4 ReadACRNEMAIImage()

```
bool gdcm::ImageReader::ReadACRNEMAIImage ( ) [override], [protected], [virtual]
```

Reimplemented from [gdcm::PixmapReader](#).

### 10.153.3.5 ReadImage()

```
bool gdcM::ImageReader::ReadImage (
    MediaStorage const & ms ) [override], [protected], [virtual]
```

Reimplemented from [gdcM::PixmapReader](#).

The documentation for this class was generated from the following file:

- [gdcMImageReader.h](#)

## 10.154 gdcM::ImageRegionReader Class Reference

[ImageRegionReader](#).

```
#include <gdcMImageRegionReader.h>
```

Inheritance diagram for gdcM::ImageRegionReader:

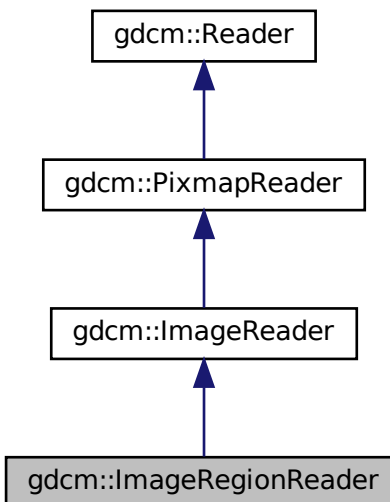

Collaboration diagram for gdcm::ImageRegionReader:

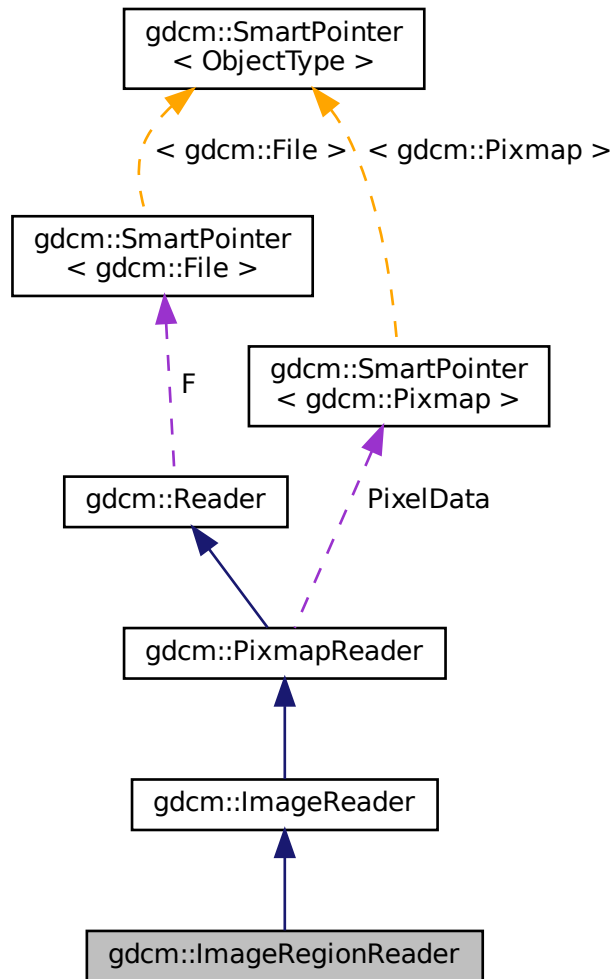

## Public Member Functions

- [ImageRegionReader](#) ()
- [~ImageRegionReader](#) () override
- [size\\_t ComputeBufferLength](#) () const
- [Region](#) const & [GetRegion](#) () const
- [bool ReadInformation](#) ()
- [bool ReadIntoBuffer](#) (char \*inreadbuffer, size\_t buflen)
- [void SetRegion](#) ([Region](#) const &region)

*Set/Get [Region](#) to be read.*

## Protected Member Functions

- bool [Read](#) () override

*To prevent user from calling super class [Read\(\)](#) function.*

## Additional Inherited Members

### 10.154.1 Detailed Description

[ImageRegionReader](#).

This class is able to read a region from a DICOM file containing an image. This implementation requires that the information stored in the DICOM header are consistent with what is in the encapsulated Pixel Data. This is technically not required by DICOM standard, which makes this implementation illegal with regards to the famous JPEG note: [http://dicom.nema.org/medical/dicom/current/output/chtml/part05/sect\\_8.2.html#para\\_4bcb841e-c6bf-4e26-82a5-3fad3c942da0](http://dicom.nema.org/medical/dicom/current/output/chtml/part05/sect_8.2.html#para_4bcb841e-c6bf-4e26-82a5-3fad3c942da0)

See also

[ImageReader](#)

Examples

[TemplateEmptyImage.cxx](#).

### 10.154.2 Constructor & Destructor Documentation

#### 10.154.2.1 ImageRegionReader()

```
gdcm::ImageRegionReader::ImageRegionReader ( )
```

#### 10.154.2.2 ~ImageRegionReader()

```
gdcm::ImageRegionReader::~ImageRegionReader ( ) [override]
```

### 10.154.3 Member Function Documentation



### 10.154.3.1 ComputeBufferLength()

```
size_t gdcm::ImageRegionReader::ComputeBufferLength ( ) const
```

Explicit call which will compute the minimal buffer length that can hold the whole uncompressed image as defined by [Region](#) region.

#### Returns

0 upon error

### 10.154.3.2 GetRegion()

```
Region const& gdcm::ImageRegionReader::GetRegion ( ) const
```

### 10.154.3.3 Read()

```
bool gdcm::ImageRegionReader::Read ( ) [override], [protected], [virtual]
```

To prevent user from calling super class [Read\(\)](#) function.

Reimplemented from [gdcm::ImageReader](#).

### 10.154.3.4 ReadInformation()

```
bool gdcm::ImageRegionReader::ReadInformation ( )
```

Read meta information (not Pixel Data) from the DICOM file.

#### Returns

false upon error

#### Examples

[TemplateEmptyImage.cxx](#).

### 10.154.3.5 ReadIntoBuffer()

```
bool gdcM::ImageRegionReader::ReadIntoBuffer (
    char * inreadbuffer,
    size_t buflen )
```

Read into buffer: For Python, the `buflen` param is deduced directly from the input bytearray passed as parameter (function only takes one param).

#### Returns

false upon error

### 10.154.3.6 SetRegion()

```
void gdcM::ImageRegionReader::SetRegion (
    Region const & region )
```

Set/Get [Region](#) to be read.

The documentation for this class was generated from the following file:

- [gdcMImageRegionReader.h](#)

## 10.155 gdcM::ImageToImageFilter Class Reference

[ImageToImageFilter](#) class.

```
#include <gdcMImageToImageFilter.h>
```

Inheritance diagram for `gdcM::ImageToImageFilter`:

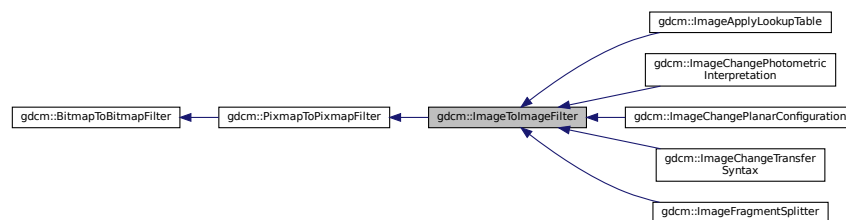

Collaboration diagram for gdcm::ImageToImageFilter:

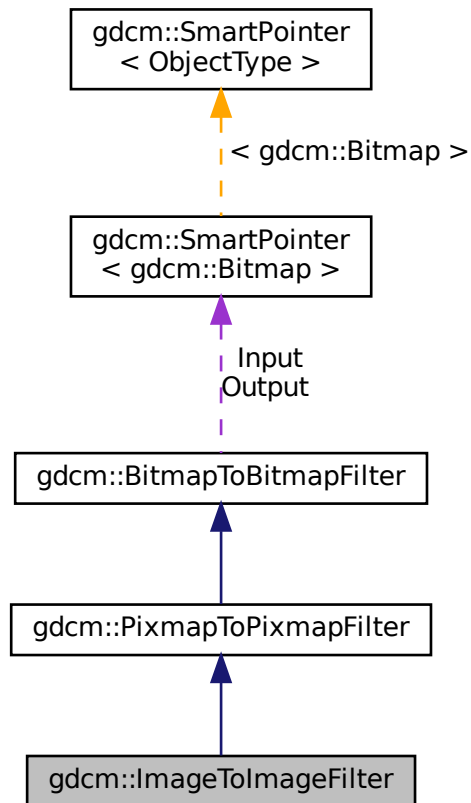

## Public Member Functions

- [ImageToImageFilter \(\)](#)
- [~ImageToImageFilter \(\)](#)=default
- [Image & GetInput \(\)](#)
- [const Image & GetOutput \(\)](#) const  
*Get Output image.*

## Additional Inherited Members

### 10.155.1 Detailed Description

[ImageToImageFilter](#) class.

Super class for all filter taking an image and producing an output image

## 10.155.2 Constructor & Destructor Documentation

### 10.155.2.1 ImageToImageFilter()

```
gdcM::ImageToImageFilter::ImageToImageFilter ( )
```

### 10.155.2.2 ~ImageToImageFilter()

```
gdcM::ImageToImageFilter::~~ImageToImageFilter ( ) [default]
```

## 10.155.3 Member Function Documentation

### 10.155.3.1 GetInput()

```
Image& gdcM::ImageToImageFilter::GetInput ( )
```

### 10.155.3.2 GetOutput()

```
const Image& gdcM::ImageToImageFilter::GetOutput ( ) const
```

Get Output image.

#### Examples

[CompressImage.cxx](#).

The documentation for this class was generated from the following file:

- [gdcMImageToImageFilter.h](#)

## 10.156 gdcm::ImageWriter Class Reference

[ImageWriter](#).

```
#include <gdcmImageWriter.h>
```

Inheritance diagram for gdcm::ImageWriter:

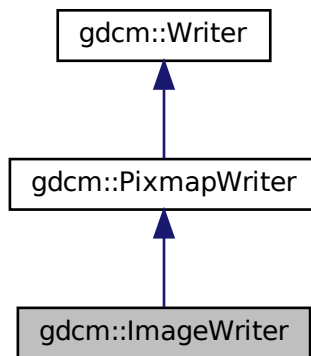

Collaboration diagram for `gdcm::ImageWriter`:

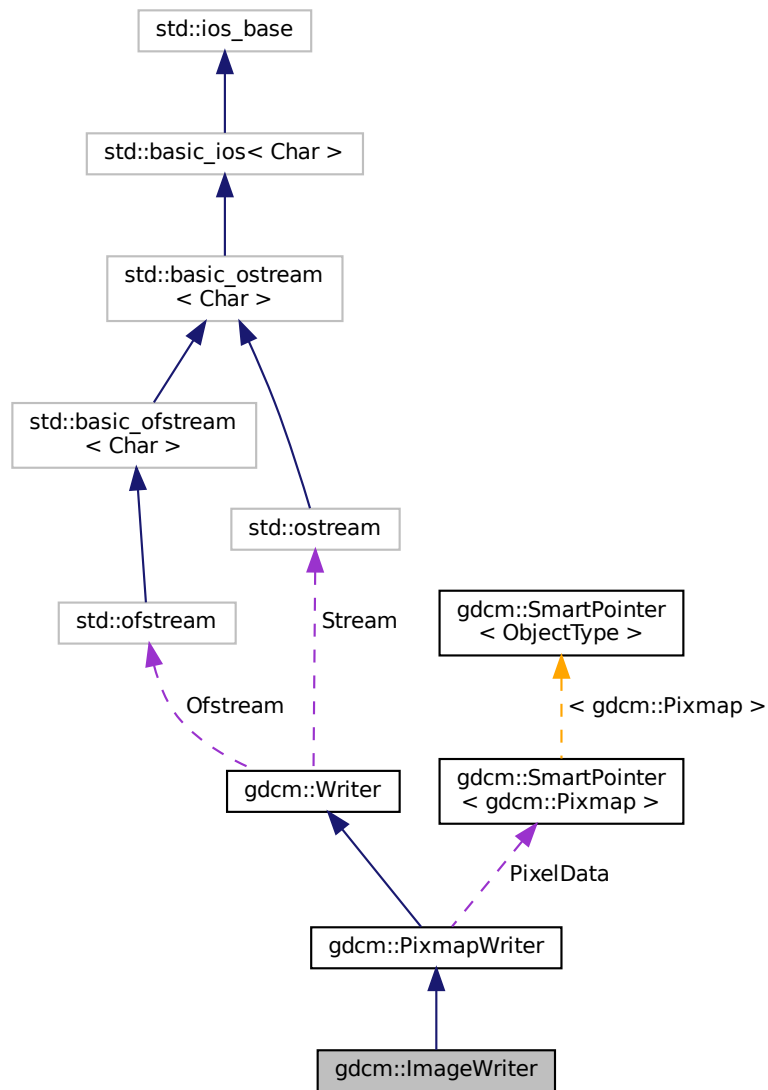

## Public Member Functions

- `ImageWriter ()`
- `~ImageWriter ()` override
- `MediaStorage ComputeTargetMediaStorage ()`
- `const Image & GetImage ()` const override
- `Image & GetImage ()` override
- `bool Write ()` override

*Write.*

## Additional Inherited Members

### 10.156.1 Detailed Description

[ImageWriter](#).

This is an extended version of the [PixmapWriter](#). Pay attention that:

1. It will populate missing attribute for Secondary Capture [Image](#) Storage instances,
2. It may also change an input MR [Image](#) Storage instance into a pseudo Enhanced MR [Image](#) Storage instance whenever Modality LUT is required.
3. Some [DataElement](#) related to [gdcm::Image](#) may be slightly altered.

#### Examples

[CompressImage.cxx](#), [CreateARGBImage.cxx](#), [CreateCMYKImage.cxx](#), [GenFakelImage.cxx](#), [GetSubSequenceData.cxx](#), [HelloVizWorld.cxx](#), [MergeTwoFiles.cxx](#), [TemplateEmptyImage.cxx](#), [csa2img.cxx](#), and [iU22tomultisc.cxx](#).

### 10.156.2 Constructor & Destructor Documentation

#### 10.156.2.1 ImageWriter()

```
gdcm::ImageWriter::ImageWriter ( )
```

#### 10.156.2.2 ~ImageWriter()

```
gdcm::ImageWriter::~ImageWriter ( ) [override]
```

### 10.156.3 Member Function Documentation

### 10.156.3.1 ComputeTargetMediaStorage()

`MediaStorage` `gdcm::ImageWriter::ComputeTargetMediaStorage ( )`

internal function used to compute a target `MediaStorage` the most appropriate User may want to call this function ahead of time (before Write)

#### Examples

[TemplateEmptyImage.cxx](#).

### 10.156.3.2 GetImage() [1/2]

`const Image&` `gdcm::ImageWriter::GetImage ( ) const` `[inline], [override], [virtual]`

Set/Get `Image` to be written It will overwrite anything `Image` infos found in `DataSet` (see parent class to see how to pass dataset)

Reimplemented from `gdcm::PixmapWriter`.

#### Examples

[CreateARGBImage.cxx](#), [CreateCMYKImage.cxx](#), [csa2img.cxx](#), and [iU22tomultisc.cxx](#).

### 10.156.3.3 GetImage() [2/2]

`Image&` `gdcm::ImageWriter::GetImage ( )` `[inline], [override], [virtual]`

Reimplemented from `gdcm::PixmapWriter`.

### 10.156.3.4 Write()

`bool` `gdcm::ImageWriter::Write ( )` `[override], [virtual]`

Write.

Reimplemented from `gdcm::Writer`.

#### Examples

[CompressImage.cxx](#), [CreateARGBImage.cxx](#), [CreateCMYKImage.cxx](#), [GenFakelImage.cxx](#), [GetSubSequenceData.cxx](#), [HelloVizWorld.cxx](#), [MergeTwoFiles.cxx](#), [TemplateEmptyImage.cxx](#), [csa2img.cxx](#), and [iU22tomultisc.cxx](#).

The documentation for this class was generated from the following file:

- [gdcmImageWriter.h](#)



## 10.157 gdcM::network::ImplementationClassUIDSub Class Reference

[ImplementationClassUIDSub](#).

```
#include <gdcMImplementationClassUIDSub.h>
```

### Public Member Functions

- [ImplementationClassUIDSub](#) ()
- void [Print](#) (std::ostream &os) const
- std::istream & [Read](#) (std::istream &is)
- size\_t [Size](#) () const
- const std::ostream & [Write](#) (std::ostream &os) const

### 10.157.1 Detailed Description

[ImplementationClassUIDSub](#).

PS 3.7 [Table D.3-1](#) IMPLEMENTATION CLASS UID SUB-ITEM FIELDS (A-ASSOCIATE-RQ)

### 10.157.2 Constructor & Destructor Documentation

#### 10.157.2.1 ImplementationClassUIDSub()

```
gdcM::network::ImplementationClassUIDSub::ImplementationClassUIDSub ( )
```

### 10.157.3 Member Function Documentation

#### 10.157.3.1 Print()

```
void gdcM::network::ImplementationClassUIDSub::Print (
    std::ostream & os ) const
```

### 10.157.3.2 Read()

```
std::istream& gdcm::network::ImplementationClassUIDSub::Read (
    std::istream & is )
```

### 10.157.3.3 Size()

```
size_t gdcm::network::ImplementationClassUIDSub::Size ( ) const
```

### 10.157.3.4 Write()

```
const std::ostream& gdcm::network::ImplementationClassUIDSub::Write (
    std::ostream & os ) const
```

The documentation for this class was generated from the following file:

- [gdcmImplementationClassUIDSub.h](#)

## 10.158 gdcm::network::ImplementationUIDSub Class Reference

[ImplementationUIDSub](#).

```
#include <gdcmImplementationUIDSub.h>
```

### Public Member Functions

- [ImplementationUIDSub](#) ()
- const std::ostream & [Write](#) (std::ostream &os) const

### 10.158.1 Detailed Description

[ImplementationUIDSub](#).

[Table D.3-2 IMPLEMENTATION UID SUB-ITEM FIELDS \(A-ASSOCIATE-AC\)](#)

### 10.158.2 Constructor & Destructor Documentation

### 10.158.2.1 ImplementationUIDSub()

```
gdcm::network::ImplementationUIDSub::ImplementationUIDSub ( )
```

## 10.158.3 Member Function Documentation

### 10.158.3.1 Write()

```
const std::ostream& gdcm::network::ImplementationUIDSub::Write (
    std::ostream & os ) const
```

The documentation for this class was generated from the following file:

- [gdcmImplementationUIDSub.h](#)

## 10.159 gdcm::network::ImplementationVersionNameSub Class Reference

[ImplementationVersionNameSub.](#)

```
#include <gdcmImplementationVersionNameSub.h>
```

### Public Member Functions

- [ImplementationVersionNameSub](#) ()
- void [Print](#) (std::ostream &os) const
- std::istream & [Read](#) (std::istream &is)
- size\_t [Size](#) () const
- const std::ostream & [Write](#) (std::ostream &os) const

### 10.159.1 Detailed Description

[ImplementationVersionNameSub.](#)

[Table D.3-3](#) IMPLEMENTATION VERSION NAME SUB-ITEM FIELDS (A-ASSOCIATE-RQ)

### 10.159.2 Constructor & Destructor Documentation

### 10.159.2.1 ImplementationVersionNameSub()

```
gdcM::network::ImplementationVersionNameSub::ImplementationVersionNameSub ( )
```

## 10.159.3 Member Function Documentation

### 10.159.3.1 Print()

```
void gdcM::network::ImplementationVersionNameSub::Print (
    std::ostream & os ) const
```

### 10.159.3.2 Read()

```
std::istream& gdcM::network::ImplementationVersionNameSub::Read (
    std::istream & is )
```

### 10.159.3.3 Size()

```
size_t gdcM::network::ImplementationVersionNameSub::Size ( ) const
```

### 10.159.3.4 Write()

```
const std::ostream& gdcM::network::ImplementationVersionNameSub::Write (
    std::ostream & os ) const
```

The documentation for this class was generated from the following file:

- [gdcMImplementationVersionNameSub.h](#)

## 10.160 gdcm::ImplicitDataElement Class Reference

Class to represent an *Implicit VR Data Element*.

```
#include <gdcmImplicitDataElement.h>
```

Inheritance diagram for gdcm::ImplicitDataElement:

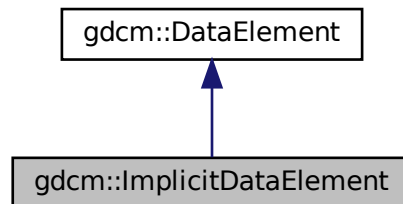

Collaboration diagram for gdcm::ImplicitDataElement:

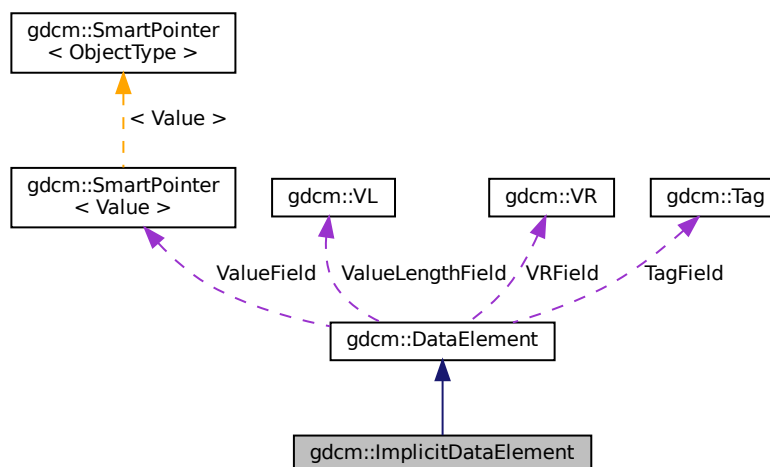

### Public Member Functions

- [VL GetLength](#) () const
- `template<typename TSwap >`  
std::istream & [Read](#) (std::istream &is)

- `template<typename TSwap >`  
`std::istream & ReadPreValue (std::istream &is)`
- `template<typename TSwap >`  
`std::istream & ReadValue (std::istream &is, bool readvalues=true)`
- `template<typename TSwap >`  
`std::istream & ReadValueWithLength (std::istream &is, VL &length, bool readvalues=true)`
- `template<typename TSwap >`  
`std::istream & ReadWithLength (std::istream &is, VL &length, bool readvalues=true)`
- `template<typename TSwap >`  
`const std::ostream & Write (std::ostream &os) const`

## Additional Inherited Members

### 10.160.1 Detailed Description

Class to represent an *Implicit VR Data Element*.

#### Note

bla

### 10.160.2 Member Function Documentation

#### 10.160.2.1 GetLength()

```
VL gdcmm::ImplicitDataElement::GetLength ( ) const
```

#### 10.160.2.2 Read()

```
template<typename TSwap >  
std::istream& gdcmm::ImplicitDataElement::Read (  
    std::istream & is )
```

#### 10.160.2.3 ReadPreValue()

```
template<typename TSwap >  
std::istream& gdcmm::ImplicitDataElement::ReadPreValue (  
    std::istream & is )
```

### 10.160.2.4 ReadValue()

```
template<typename TSwap >
std::istream& gdcm::ImplicitDataElement::ReadValue (
    std::istream & is,
    bool readvalues = true )
```

### 10.160.2.5 ReadValueWithLength()

```
template<typename TSwap >
std::istream& gdcm::ImplicitDataElement::ReadValueWithLength (
    std::istream & is,
    VL & length,
    bool readvalues = true )
```

### 10.160.2.6 ReadWithLength()

```
template<typename TSwap >
std::istream& gdcm::ImplicitDataElement::ReadWithLength (
    std::istream & is,
    VL & length,
    bool readvalues = true )
```

### 10.160.2.7 Write()

```
template<typename TSwap >
const std::ostream& gdcm::ImplicitDataElement::Write (
    std::ostream & os ) const
```

The documentation for this class was generated from the following file:

- [gdcmImplicitDataElement.h](#)

## 10.161 gdcM::InitializeEvent Class Reference

```
#include <gdcMEvent.h>
```

Inheritance diagram for gdcM::InitializeEvent:

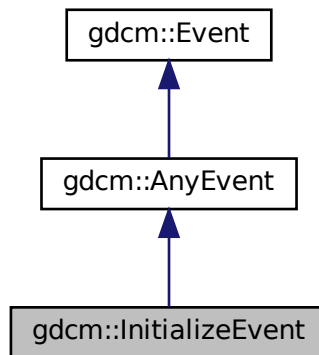

Collaboration diagram for gdcM::InitializeEvent:

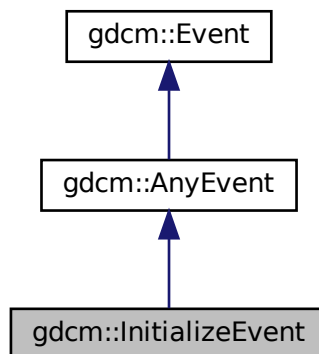

### Additional Inherited Members

The documentation for this class was generated from the following file:

- [gdcMEvent.h](#)



## 10.162 gdcm::IOD Class Reference

Class for representing a [IOD](#).

```
#include <gdcmIOD.h>
```

### Public Types

- typedef std::vector< [IODEntry](#) > [MapIODEntry](#)
- typedef MapIODEntry::size\_type [SizeType](#)

### Public Member Functions

- [IOD](#) ()=default
- void [AddIODEntry](#) (const [IODEntry](#) &iode)
- void [Clear](#) ()
- const [IODEntry](#) & [GetIODEntry](#) ([SizeType](#) idx) const
- [SizeType](#) [GetNumberOfIODs](#) () const
- [Type](#) [GetTypeFromTag](#) (const [Defs](#) &defs, const [Tag](#) &tag) const

### Friends

- std::ostream & [operator<<](#) (std::ostream &\_os, const [IOD](#) &\_val)

#### 10.162.1 Detailed Description

Class for representing a [IOD](#).

#### Note

bla

#### See also

[Dict](#)

#### 10.162.2 Member Typedef Documentation

### 10.162.2.1 MapIODEntry

```
typedef std::vector<IODEntry> gdcm::IOD::MapIODEntry
```

### 10.162.2.2 SizeType

```
typedef MapIODEntry::size_type gdcm::IOD::SizeType
```

## 10.162.3 Constructor & Destructor Documentation

### 10.162.3.1 IOD()

```
gdcm::IOD::IOD ( ) [default]
```

## 10.162.4 Member Function Documentation

### 10.162.4.1 AddIODEntry()

```
void gdcm::IOD::AddIODEntry (
    const IODEntry & iode ) [inline]
```

### 10.162.4.2 Clear()

```
void gdcm::IOD::Clear ( ) [inline]
```

### 10.162.4.3 GetIODEntry()

```
const IODEntry& gdcm::IOD::GetIODEntry (
    SizeType idx ) const [inline]
```

#### 10.162.4.4 GetNumberOfIODs()

```
SizeType gdcmlOD::IOD::GetNumberOfIODs ( ) const [inline]
```

#### 10.162.4.5 GetTypeFromTag()

```
Type gdcmlOD::IOD::GetTypeFromTag (
    const Defs & defs,
    const Tag & tag ) const
```

### 10.162.5 Friends And Related Function Documentation

#### 10.162.5.1 operator<<

```
std::ostream& operator<< (
    std::ostream & _os,
    const IOD & _val ) [friend]
```

The documentation for this class was generated from the following file:

- [gdcmlOD.h](#)

## 10.163 gdcmlODEntry Class Reference

Class for representing a [IODEntry](#).

```
#include <gdcmlODEntry.h>
```

### Public Member Functions

- [IODEntry](#) (const char \*name="", const char \*ref="", const char \*usag="")
- const char \* [GetIE](#) () const
- const char \* [GetName](#) () const
- const char \* [GetRef](#) () const
- const char \* [GetUsage](#) () const
- [Usage::UsageType](#) [GetUsageType](#) () const
- void [SetIE](#) (const char \*ie)
- void [SetName](#) (const char \*name)
- void [SetRef](#) (const char \*ref)
- void [SetUsage](#) (const char \*usag)

## Friends

- `std::ostream & operator<<` (`std::ostream &_os, const IODEntry &_val`)

### 10.163.1 Detailed Description

Class for representing a [IODEntry](#).

#### Note

A.1.3 [IOD Module Table](#) and Functional Group [Macro Table](#) This Section of each [IOD](#) defines in a tabular form the [Modules](#) comprising the [IOD](#). The following information must be specified for each [Module](#) in the table:

- The name of the [Module](#) or Functional Group
- A reference to the Section in Annex C which defines the [Module](#) or Functional Group
- The usage of the [Module](#) or Functional Group; whether it is:
  - Mandatory (see A.1.3.1) , abbreviated M
  - Conditional (see A.1.3.2) , abbreviated C
  - User Option (see A.1.3.3) , abbreviated U
- The [Modules](#) referenced are defined in Annex C. A.1.3.1 MANDATORY MODULES For each [IOD](#), Mandatory [Modules](#) shall be supported per the definitions, semantics and requirements defined in Annex C. PS 3.3 - 2008 Page 96
- Standard - A.1.3.2 CONDITIONAL MODULES Conditional [Modules](#) are Mandatory [Modules](#) if specific conditions are met. If the specified conditions are not met, this [Module](#) shall not be supported; that is, no information defined in that [Module](#) shall be sent. A.1.3.3 USER OPTION MODULES User Option [Modules](#) may or may not be supported. If an optional [Module](#) is supported, the [Attribute](#) Types specified in the [Modules](#) in Annex C shall be supported.

See also

[DictEntry](#)

### 10.163.2 Constructor & Destructor Documentation

#### 10.163.2.1 IODEntry()

```
gdcmm::IODEntry::IODEntry (
    const char * name = "",
    const char * ref = "",
    const char * usag = "" ) [inline]
```

### 10.163.3 Member Function Documentation

### 10.163.3.1 GetIE()

```
const char* gdcm::IODEntry::GetIE ( ) const [inline]
```

### 10.163.3.2 GetName()

```
const char* gdcm::IODEntry::GetName ( ) const [inline]
```

### 10.163.3.3 GetRef()

```
const char* gdcm::IODEntry::GetRef ( ) const [inline]
```

### 10.163.3.4 GetUsage()

```
const char* gdcm::IODEntry::GetUsage ( ) const [inline]
```

### 10.163.3.5 GetUsageType()

```
Usage::UsageType gdcm::IODEntry::GetUsageType ( ) const
```

### 10.163.3.6 SetIE()

```
void gdcm::IODEntry::SetIE (
    const char * ie ) [inline]
```

### 10.163.3.7 SetName()

```
void gdcm::IODEntry::SetName (
    const char * name ) [inline]
```

### 10.163.3.8 SetRef()

```
void gdcM::IODEntry::SetRef (
    const char * ref ) [inline]
```

### 10.163.3.9 SetUsage()

```
void gdcM::IODEntry::SetUsage (
    const char * usag ) [inline]
```

## 10.163.4 Friends And Related Function Documentation

### 10.163.4.1 operator<<

```
std::ostream& operator<< (
    std::ostream & _os,
    const IODEntry & _val ) [friend]
```

The documentation for this class was generated from the following file:

- [gdcMIODEntry.h](#)

## 10.164 gdcM::IODs Class Reference

Class for representing a [IODs](#).

```
#include <gdcMIODs.h>
```

### Public Types

- typedef std::map< [IODName](#), [IOD](#) > [IODMapType](#)
- typedef [IODMapType](#)::const\_iterator [IODMapTypeConstIterator](#)
- typedef std::string [IODName](#)

## Public Member Functions

- [IODs](#) ()=default
- void [AddIOD](#) (const char \*name, const [IOD](#) &module)
- [IODMapTypeConstIterator](#) [Begin](#) () const
- void [Clear](#) ()
- [IODMapTypeConstIterator](#) [End](#) () const
- const [IOD](#) & [GetIOD](#) (const char \*name) const

## Friends

- std::ostream & [operator<<](#) (std::ostream &\_os, const [IODs](#) &\_val)

### 10.164.1 Detailed Description

Class for representing a [IODs](#).

#### Note

bla

#### See also

[IOD](#)

### 10.164.2 Member Typedef Documentation

#### 10.164.2.1 IODMapType

```
typedef std::map<IODName, IOD> gdcm::IODs::IODMapType
```

#### 10.164.2.2 IODMapTypeConstIterator

```
typedef IODMapType::const_iterator gdcm::IODs::IODMapTypeConstIterator
```

#### Examples

[TraverseModules.cxx](#).

### 10.164.2.3 IODName

```
typedef std::string gdcm::IODs::IODName
```

#### Examples

[TraverseModules.cxx](#).

## 10.164.3 Constructor & Destructor Documentation

### 10.164.3.1 IODs()

```
gdcm::IODs::IODs ( ) [default]
```

## 10.164.4 Member Function Documentation

### 10.164.4.1 AddIOD()

```
void gdcm::IODs::AddIOD (
    const char * name,
    const IOD & module ) [inline]
```

### 10.164.4.2 Begin()

```
IODMapTypeConstIterator gdcm::IODs::Begin ( ) const [inline]
```

### 10.164.4.3 Clear()

```
void gdcm::IODs::Clear ( ) [inline]
```



#### 10.164.4.4 End()

```
IODMapTypeConstIterator gdcm::IODs::End ( ) const [inline]
```

#### 10.164.4.5 GetIOD()

```
const IOD& gdcm::IODs::GetIOD (
    const char * name ) const [inline]
```

### 10.164.5 Friends And Related Function Documentation

#### 10.164.5.1 operator<<

```
std::ostream& operator<< (
    std::ostream & _os,
    const IODs & _val ) [friend]
```

The documentation for this class was generated from the following file:

- [gdcmIODs.h](#)

## 10.165 gdcm::IPPSorter Class Reference

[IPPSorter](#).

```
#include <gdcmIPPSorter.h>
```

Inheritance diagram for gdcm::IPPSorter:

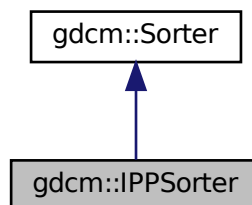

Collaboration diagram for `gdcm::IPPSorter`:

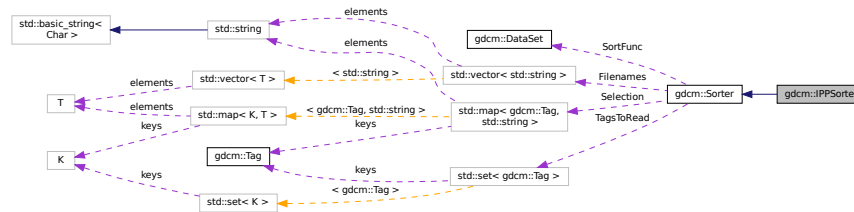

## Public Member Functions

- [IPPSorter](#) ()
- double [GetDirectionCosinesTolerance](#) () const
- double [GetZSpacing](#) () const
- double [GetZSpacingTolerance](#) () const
- void [SetComputeZSpacing](#) (bool b)
- void [SetDirectionCosinesTolerance](#) (double tol)
- void [SetDropDuplicatePositions](#) (bool b)
- void [SetZSpacingTolerance](#) (double tol)
- bool [Sort](#) (std::vector< std::string > const &filenames) override

## Protected Attributes

- bool [ComputeZSpacing](#)
- double [DirCosTolerance](#)
- bool [DropDuplicatePositions](#)
- double [ZSpacing](#)
- double [ZTolerance](#)

## Additional Inherited Members

### 10.165.1 Detailed Description

[IPPSorter](#).

Implement a simple [Image](#) Position ([Patient](#)) sorter, along the [Image Orientation](#) ([Patient](#)) direction. This algorithm does NOT support duplicate and will FAIL in case of duplicate IPP.

### Warning

See special note for `SetZSpacingTolerance` when computing the `ZSpacing` from the IPP of each DICOM files (default tolerance for consistent spacing is: 1e-6mm)

For more information on [Spacing](#), and how it is defined in DICOM, advanced users may refer to:

[http://gdcm.sourceforge.net/wiki/index.php/Imager\\_Pixel\\_Spacing](http://gdcm.sourceforge.net/wiki/index.php/Imager_Pixel_Spacing)

**Bug** There are currently a couple of bugs in this implementation:

- Gantry Tilt is not considered (always an error)
- Application programmer should only sort valid `DataSet` (eg. `MRImageStorage`, `CTImageStorage`, `PETImageStorage`)

### Examples

[Compute3DSpacing.cxx](#), [VolumeSorter.cxx](#), [gdcmorthoplanes.cxx](#), and [reslicesphere.cxx](#).

## 10.165.2 Constructor & Destructor Documentation

### 10.165.2.1 IPPSorter()

```
gdcm::IPPSorter::IPPSorter ( )
```

## 10.165.3 Member Function Documentation

### 10.165.3.1 GetDirectionCosinesTolerance()

```
double gdcm::IPPSorter::GetDirectionCosinesTolerance ( ) const [inline]
```

### 10.165.3.2 GetZSpacing()

```
double gdc::IPPSorter::GetZSpacing ( ) const [inline]
```

Read-only function to provide access to the computed value for the Z-Spacing The ComputeZSpacing must have been set to true before execution of sort algorithm. Call this function *after* calling [Sort\(\)](#); Z-Spacing will be 0 on 2 occasions:

- Sorting simply failed, potentially duplicate IPP => ZSpacing = 0
- ZSpacing could not be computed (Z-Spacing is not constant, or ZTolerance is too low)

#### Examples

[Compute3DSpacing.cxx](#), [gdcmorphoplanes.cxx](#), and [reslicesphere.cxx](#).

### 10.165.3.3 GetZSpacingTolerance()

```
double gdc::IPPSorter::GetZSpacingTolerance ( ) const [inline]
```

### 10.165.3.4 SetComputeZSpacing()

```
void gdc::IPPSorter::SetComputeZSpacing (
    bool b ) [inline]
```

Functions related to Z-Spacing computation Set to true when sort algorithm should also perform a regular Z-Spacing computation using the [Image](#) Position ([Patient](#)) Potential reason for failure:

1. ALL slices are taken into account, if one slice is missing then ZSpacing will be set to 0 since the spacing will not be found to be regular along the [Series](#)

#### Examples

[Compute3DSpacing.cxx](#), [VolumeSorter.cxx](#), [gdcmorphoplanes.cxx](#), and [reslicesphere.cxx](#).

### 10.165.3.5 SetDirectionCosinesTolerance()

```
void gdc::IPPSorter::SetDirectionCosinesTolerance (
    double tol ) [inline]
```

Sometimes IOP along a series is slightly changing for example: "0.999081\0.0426953\0.00369272\0.0419025\0.↔955059\0.293439", "0.999081\0.0426953\0.00369275\0.0419025\0.955059\0.293439", "0.999081\0.0426952\0.↔00369272\0.0419025\0.955059\0.293439", We need an API to define the tolerance which is allowed. Internally the cross vector of each direction cosines is computed. The tolerance then define the distance in between 1.0 to the dot product of those cross vectors. In a perfect world this dot product is of course 1.0 which imply a [DirectionCosines](#) tolerance of exactly 0.0 (default).

### 10.165.3.6 SetDropDuplicatePositions()

```
void gdcmm::IPPSorter::SetDropDuplicatePositions (
    bool b ) [inline]
```

Makes the [IPPSorter](#) ignore multiple images located at the same position. Only the first occurrence will be kept. DropDuplicatePositions defaults to false.

### 10.165.3.7 SetZSpacingTolerance()

```
void gdcmm::IPPSorter::SetZSpacingTolerance (
    double tol ) [inline]
```

1. Another reason for failure is that that Z-Spacing is only slightly changing (eg 1e-3) along the series, a human can determine that this is ok and change the tolerance from its default value: 1e-6

#### Examples

[Compute3DSpacing.cxx](#), [gdcmmorthoplanes.cxx](#), and [reslicesphere.cxx](#).

### 10.165.3.8 Sort()

```
bool gdcmm::IPPSorter::Sort (
    std::vector< std::string > const & filenames ) [override], [virtual]
```

Main entry point to the sorter. It will execute the filter, option should be set before running this function (SetZSpacingTolerance, ...) Return value indicate if sorting could be achieved,. Warning this does *NOT* imply that spacing is consistent, it only means the file are sorted according to IPP You should check if ZSpacing is 0 or not to deduce if file are actually a 3D volume

Reimplemented from [gdcmm::Sorter](#).

#### Examples

[Compute3DSpacing.cxx](#), [VolumeSorter.cxx](#), [gdcmmorthoplanes.cxx](#), and [reslicesphere.cxx](#).

## 10.165.4 Member Data Documentation

### 10.165.4.1 ComputeZSpacing

```
bool gdcmm::IPPSorter::ComputeZSpacing [protected]
```

#### 10.165.4.2 DirCosTolerance

```
double gdcM::IPPSorter::DirCosTolerance [protected]
```

#### 10.165.4.3 DropDuplicatePositions

```
bool gdcM::IPPSorter::DropDuplicatePositions [protected]
```

#### 10.165.4.4 ZSpacing

```
double gdcM::IPPSorter::ZSpacing [protected]
```

#### 10.165.4.5 ZTolerance

```
double gdcM::IPPSorter::ZTolerance [protected]
```

The documentation for this class was generated from the following file:

- [gdcMIPPSorter.h](#)

## 10.166 gdcM::Item Class Reference

Class to represent an [Item](#).

```
#include <gdcMItem.h>
```

Inheritance diagram for gdcM::Item:

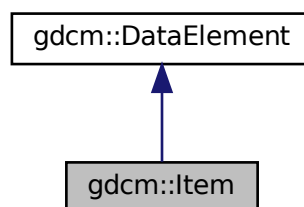

Collaboration diagram for gdcM::Item:

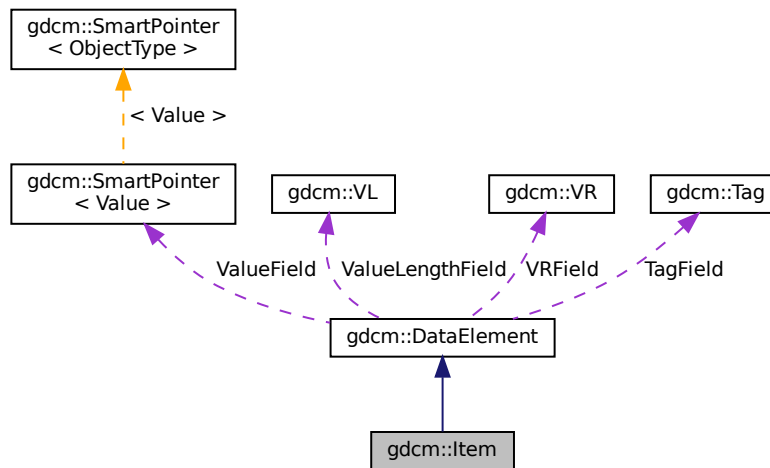

## Public Member Functions

- [Item](#) ()
- [Item](#) ([Item](#) const &val)
- void [Clear](#) ()
- bool [FindDataElement](#) (const [Tag](#) &t) const
- const [DataElement](#) & [GetDataElement](#) (const [Tag](#) &t) const
- template<typename TDE >  
[VL](#) [GetLength](#) () const
- [DataSet](#) & [GetNestedDataSet](#) ()
- const [DataSet](#) & [GetNestedDataSet](#) () const
- void [InsertDataElement](#) (const [DataElement](#) &de)
- template<typename TDE , typename TSwap >  
std::istream & [Read](#) (std::istream &is)
- void [SetNestedDataSet](#) (const [DataSet](#) &nested)
- template<typename TDE , typename TSwap >  
const std::ostream & [Write](#) (std::ostream &os) const

## Friends

- std::ostream & [operator<<](#) (std::ostream &os, const [Item](#) &val)

## Additional Inherited Members

### 10.166.1 Detailed Description

Class to represent an [Item](#).

A component of the value of a Data [Element](#) that is of [Value](#) Representation Sequence of Items. An [Item](#) contains a Data Set . See PS 3.5 7.5.1 [Item](#) Encoding Rules Each [Item](#) of a Data [Element](#) of [VR](#) SQ shall be encoded as a DICOM Standard Data [Element](#) with a specific Data [Element Tag](#) of [Value](#) (FFFE,E000). The [Item Tag](#) is followed by a 4 byte [Item](#) Length field encoded in one of the following two ways Explicit/ Implicit

#### Note

ITEM: A component of the [Value](#) of a Data [Element](#) that is of [Value](#) Representation Sequence of Items. An [Item](#) contains a Data Set.

#### Examples

[ChangeSequenceUltrasound.cxx](#), [DumpExamCard.cxx](#), [DumpGEMSMovieGroup.cxx](#), [DumpToshibaDTI.cxx](#), [DumpToshibaDTI2.cxx](#), [ExtractEncryptedContent.cxx](#), [Extracting\\_All\\_Resolution.cxx](#), [Fake\\_Image\\_Using\\_Stream\\_Image\\_Writer.cxx](#), [GenAllVR.cxx](#), [GenFakeIdentifyFile.cxx](#), [GenLongSeqs.cxx](#), [GenSeqs.cxx](#), [GetSequenceUltrasound.cxx](#), [LargeVRDSExplicit.cxx](#), [gdcmrtonplan.cxx](#), and [gdcmrtpplan.cxx](#).

### 10.166.2 Constructor & Destructor Documentation

#### 10.166.2.1 Item() [1/2]

```
gdcm::Item::Item ( ) [inline]
```

#### 10.166.2.2 Item() [2/2]

```
gdcm::Item::Item (
    Item const & val ) [inline]
```

### 10.166.3 Member Function Documentation



### 10.166.3.1 Clear()

```
void gdcM::Item::Clear ( ) [inline]
```

Referenced by `gdcM::SequenceOfItems::Read()`.

### 10.166.3.2 FindDataElement()

```
bool gdcM::Item::FindDataElement (
    const Tag & t ) const [inline]
```

### 10.166.3.3 GetDataElement()

```
const DataElement& gdcM::Item::GetDataElement (
    const Tag & t ) const [inline]
```

### 10.166.3.4 GetLength()

```
template<typename TDE >
VL gdcM::Item::GetLength ( ) const
```

### 10.166.3.5 GetNestedDataSet() [1/2]

```
DataSet& gdcM::Item::GetNestedDataSet ( ) [inline]
```

### 10.166.3.6 GetNestedDataSet() [2/2]

```
const DataSet& gdcM::Item::GetNestedDataSet ( ) const [inline]
```

#### Examples

[ChangeSequenceUltrasound.cxx](#), [DumpExamCard.cxx](#), [DumpGEMSMovieGroup.cxx](#), [DumpToshibaDTI.cxx](#), [DumpToshibaDTI2.cxx](#), [ExtractEncryptedContent.cxx](#), [Extracting\\_All\\_Resolution.cxx](#), [Fake\\_Image\\_Using\\_Stream\\_Image\\_Writer.cxx](#), [GenAllVR.cxx](#), [GenFakeIdentifyFile.cxx](#), [GenSeqs.cxx](#), [GetSequenceUltrasound.cxx](#), [LargeVRDSExplicit.cxx](#), [gdcMrtionplan.cxx](#), and [gdcMrtplan.cxx](#).

Referenced by `gdcM::SequenceOfItems::Read()`.

### 10.166.3.7 InsertDataElement()

```
void gdcM::Item::InsertDataElement (
    const DataElement & de ) [inline]
```

### 10.166.3.8 Read()

```
template<typename TDE , typename TSwap >
std::istream& gdcM::Item::Read (
    std::istream & is ) [inline]
```

References [gdcM::ByteSwapFilter::ByteSwap\(\)](#), [gdcM::DataSet::Clear\(\)](#), [gdcMDebugMacro](#), [gdcMErrorMacro](#), [gdcMWarningMacro](#), [gdcM::DataSet::IsEmpty\(\)](#), and [gdcM::ByteSwapFilter::SetByteSwapTag\(\)](#).

Referenced by [gdcM::SequenceOfItems::Read\(\)](#).

### 10.166.3.9 SetNestedDataSet()

```
void gdcM::Item::SetNestedDataSet (
    const DataSet & nested ) [inline]
```

### 10.166.3.10 Write()

```
template<typename TDE , typename TSwap >
const std::ostream& gdcM::Item::Write (
    std::ostream & os ) const [inline]
```

References [gdcMWarningMacro](#), [gdcM::VL::GetLength\(\)](#), [gdcM::Tag::Write\(\)](#), and [gdcM::VL::Write\(\)](#).

## 10.166.4 Friends And Related Function Documentation

### 10.166.4.1 operator<<

```
std::ostream& operator<< (
    std::ostream & os,
    const Item & val ) [friend]
```

The documentation for this class was generated from the following file:

- [gdcMItem.h](#)

## 10.167 gdcm::IterationEvent Class Reference

```
#include <gdcmEvent.h>
```

Inheritance diagram for gdcm::IterationEvent:

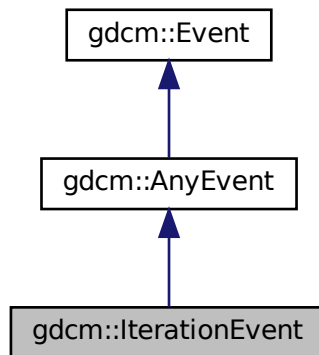

Collaboration diagram for gdcm::IterationEvent:

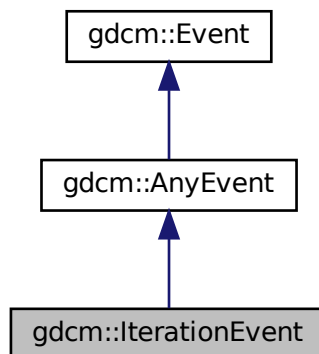

### Additional Inherited Members

The documentation for this class was generated from the following file:

- [gdcmEvent.h](#)

## 10.168 gdcM::JPEG12Codec Class Reference

Class to do JPEG 12bits (lossy & lossless)

```
#include <gdcMJPEG12Codec.h>
```

Inheritance diagram for gdcM::JPEG12Codec:

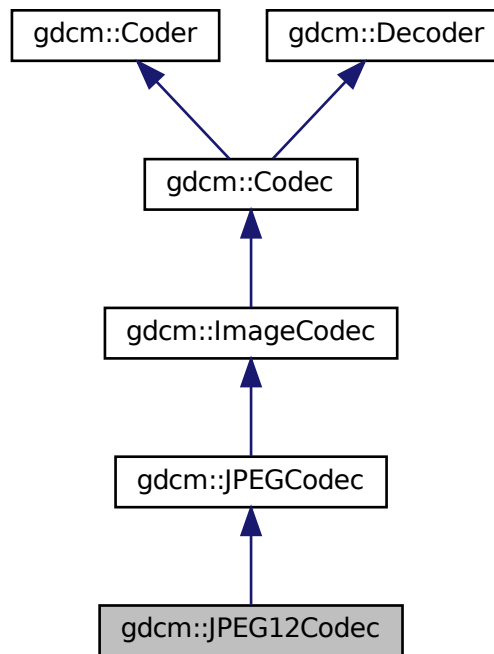

Collaboration diagram for gdcM::JPEG12Codec:

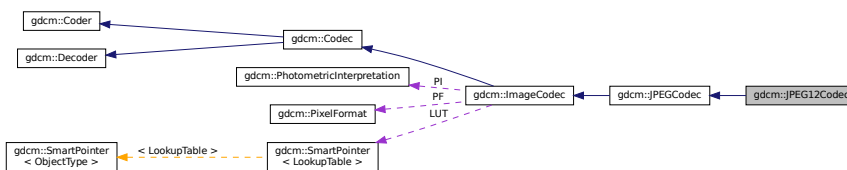

## Public Member Functions

- [JPEG12Codec](#) ()
- [~JPEG12Codec](#) () override
- bool [DecodeByStreams](#) (std::istream &is, std::ostream &os) override
- bool [GetHeaderInfo](#) (std::istream &is, [TransferSyntax](#) &ts) override
- bool [InternalCode](#) (const char \*input, unsigned long len, std::ostream &os) override

## Protected Member Functions

- bool [EncodeBuffer](#) (std::ostream &os, const char \*data, size\_t datalen) override
- bool [IsStateSuspension](#) () const override

## Additional Inherited Members

### 10.168.1 Detailed Description

Class to do JPEG 12bits (lossy & lossless)

#### Note

internal class

### 10.168.2 Constructor & Destructor Documentation

#### 10.168.2.1 JPEG12Codec()

```
gdcm::JPEG12Codec::JPEG12Codec ( )
```

#### 10.168.2.2 ~JPEG12Codec()

```
gdcm::JPEG12Codec::~~JPEG12Codec ( ) [override]
```

### 10.168.3 Member Function Documentation

### 10.168.3.1 DecodeByStreams()

```
bool gdcM::JPEG12Codec::DecodeByStreams (
    std::istream & is,
    std::ostream & os ) [override], [virtual]
```

Reimplemented from [gdcM::ImageCodec](#).

### 10.168.3.2 EncodeBuffer()

```
bool gdcM::JPEG12Codec::EncodeBuffer (
    std::ostream & os,
    const char * data,
    size_t dataLen ) [override], [protected], [virtual]
```

Reimplemented from [gdcM::JPEGCodec](#).

### 10.168.3.3 GetHeaderInfo()

```
bool gdcM::JPEG12Codec::GetHeaderInfo (
    std::istream & is,
    TransferSyntax & ts ) [override], [virtual]
```

Reimplemented from [gdcM::ImageCodec](#).

### 10.168.3.4 InternalCode()

```
bool gdcM::JPEG12Codec::InternalCode (
    const char * input,
    unsigned long len,
    std::ostream & os ) [override], [virtual]
```

Reimplemented from [gdcM::Coder](#).

### 10.168.3.5 IsStateSuspension()

```
bool gdcM::JPEG12Codec::IsStateSuspension ( ) const [override], [protected], [virtual]
```

Reimplemented from [gdcM::JPEGCodec](#).

The documentation for this class was generated from the following file:

- [gdcMJPEG12Codec.h](#)

## 10.169 gdcm::JPEG16Codec Class Reference

Class to do JPEG 16bits (lossless)

```
#include <gdcmJPEG16Codec.h>
```

Inheritance diagram for gdcm::JPEG16Codec:

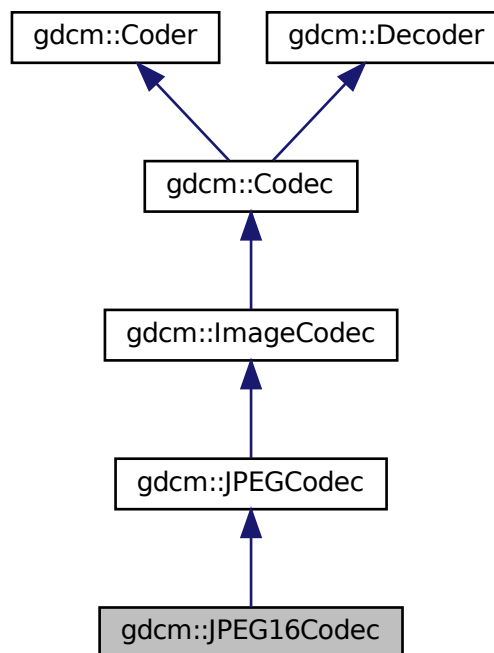

Collaboration diagram for gdcm::JPEG16Codec:

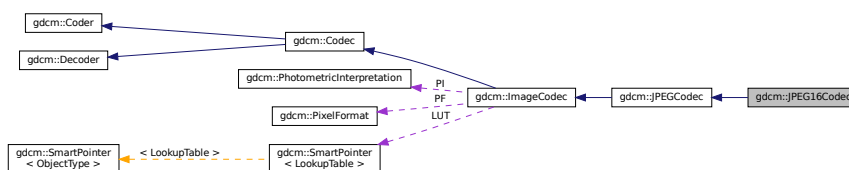

## Public Member Functions

- [JPEG16Codec](#) ()
- [~JPEG16Codec](#) () override
- bool [DecodeByStreams](#) (std::istream &is, std::ostream &os) override
- bool [GetHeaderInfo](#) (std::istream &is, [TransferSyntax](#) &ts) override
- bool [InternalCode](#) (const char \*input, unsigned long len, std::ostream &os) override

## Protected Member Functions

- bool [EncodeBuffer](#) (std::ostream &os, const char \*data, size\_t datalen) override
- bool [IsStateSuspension](#) () const override

## Additional Inherited Members

### 10.169.1 Detailed Description

Class to do JPEG 16bits (lossless)

#### Note

internal class

### 10.169.2 Constructor & Destructor Documentation

#### 10.169.2.1 JPEG16Codec()

```
gdcm::JPEG16Codec::JPEG16Codec ( )
```

#### 10.169.2.2 ~JPEG16Codec()

```
gdcm::JPEG16Codec::~~JPEG16Codec ( ) [override]
```

### 10.169.3 Member Function Documentation



### 10.169.3.1 DecodeByStreams()

```
bool gdcM::JPEG16Codec::DecodeByStreams (
    std::istream & is,
    std::ostream & os ) [override], [virtual]
```

Reimplemented from [gdcM::ImageCodec](#).

### 10.169.3.2 EncodeBuffer()

```
bool gdcM::JPEG16Codec::EncodeBuffer (
    std::ostream & os,
    const char * data,
    size_t dataLen ) [override], [protected], [virtual]
```

Reimplemented from [gdcM::JPEGCodec](#).

### 10.169.3.3 GetHeaderInfo()

```
bool gdcM::JPEG16Codec::GetHeaderInfo (
    std::istream & is,
    TransferSyntax & ts ) [override], [virtual]
```

Reimplemented from [gdcM::ImageCodec](#).

### 10.169.3.4 InternalCode()

```
bool gdcM::JPEG16Codec::InternalCode (
    const char * input,
    unsigned long len,
    std::ostream & os ) [override], [virtual]
```

Reimplemented from [gdcM::Coder](#).

### 10.169.3.5 IsStateSuspension()

```
bool gdcM::JPEG16Codec::IsStateSuspension ( ) const [override], [protected], [virtual]
```

Reimplemented from [gdcM::JPEGCodec](#).

The documentation for this class was generated from the following file:

- [gdcMJPEG16Codec.h](#)

## 10.170 gdcm::JPEG2000Codec Class Reference

Class to do JPEG 2000.

```
#include <gdcmJPEG2000Codec.h>
```

Inheritance diagram for gdcm::JPEG2000Codec:

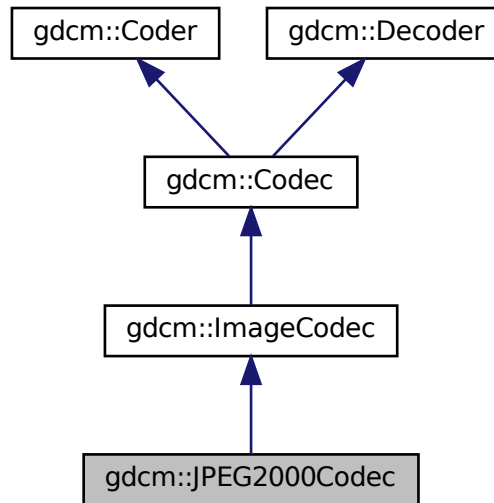

Collaboration diagram for gdcm::JPEG2000Codec:

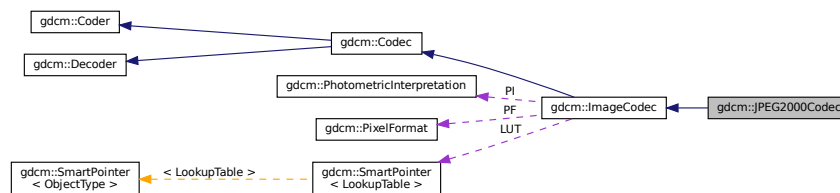

### Public Member Functions

- [JPEG2000Codec](#) ()
- [~JPEG2000Codec](#) () override
- [bool CanCode](#) ([TransferSyntax](#) const &ts) const override

*Return whether this coder support this transfer syntax (can code it)*

- bool [CanDecode](#) ([TransferSyntax](#) const &ts) const override  
*Return whether this decoder support this transfer syntax (can decode it)*
- [ImageCodec](#) \* [Clone](#) () const override
- bool [Code](#) ([DataElement](#) const &in, [DataElement](#) &out) override  
*Code.*
- bool [Decode](#) ([DataElement](#) const &is, [DataElement](#) &os) override  
*Decode.*
- bool [GetHeaderInfo](#) (std::istream &is, [TransferSyntax](#) &ts) override
- double [GetQuality](#) (unsigned int idx=0) const
- double [GetRate](#) (unsigned int idx=0) const
- void [SetMCT](#) (unsigned int mct)
- void [SetNumberOfResolutions](#) (unsigned int nres)
- void [SetNumberOfThreadsForDecompression](#) (int nThreads)
- void [SetQuality](#) (unsigned int idx, double q)
- void [SetRate](#) (unsigned int idx, double rate)
- void [SetReversible](#) (bool res)
- void [SetTileSize](#) (unsigned int tx, unsigned int ty)

## Protected Member Functions

- bool [AppendFrameEncode](#) (std::ostream &out, const char \*data, size\_t datalen) override
- bool [AppendRowEncode](#) (std::ostream &out, const char \*data, size\_t datalen) override
- bool [DecodeByStreams](#) (std::istream &is, std::ostream &os) override
- bool [DecodeExtent](#) (char \*buffer, unsigned int xmin, unsigned int xmax, unsigned int ymin, unsigned int ymax, unsigned int zmin, unsigned int zmax, std::istream &is)
- bool [IsFrameEncoder](#) () override
- bool [IsRowEncoder](#) () override
- bool [StartEncode](#) (std::ostream &) override
- bool [StopEncode](#) (std::ostream &) override

## Friends

- class [Bitmap](#)
- class [ImageRegionReader](#)

## Additional Inherited Members

### 10.170.1 Detailed Description

Class to do JPEG 2000.

#### Note

the class will produce JPC (JPEG 2000 codestream), since some private implementor are using full jp2 file the decoder tolerate jp2 input this is an implementation of an [ImageCodec](#)

## 10.170.2 Constructor & Destructor Documentation

### 10.170.2.1 JPEG2000Codec()

```
gdcM::JPEG2000Codec::JPEG2000Codec ( )
```

### 10.170.2.2 ~JPEG2000Codec()

```
gdcM::JPEG2000Codec::~~JPEG2000Codec ( ) [override]
```

## 10.170.3 Member Function Documentation

### 10.170.3.1 AppendFrameEncode()

```
bool gdcM::JPEG2000Codec::AppendFrameEncode (
    std::ostream & out,
    const char * data,
    size_t datalen ) [override], [protected], [virtual]
```

Reimplemented from [gdcM::ImageCodec](#).

### 10.170.3.2 AppendRowEncode()

```
bool gdcM::JPEG2000Codec::AppendRowEncode (
    std::ostream & out,
    const char * data,
    size_t datalen ) [override], [protected], [virtual]
```

Reimplemented from [gdcM::ImageCodec](#).

### 10.170.3.3 CanCode()

```
bool gdcm::JPEG2000Codec::CanCode (
    TransferSyntax const & ) const [override], [virtual]
```

Return whether this coder support this transfer syntax (can code it)

Reimplemented from [gdcm::ImageCodec](#).

### 10.170.3.4 CanDecode()

```
bool gdcm::JPEG2000Codec::CanDecode (
    TransferSyntax const & ) const [override], [virtual]
```

Return whether this decoder support this transfer syntax (can decode it)

Reimplemented from [gdcm::ImageCodec](#).

### 10.170.3.5 Clone()

```
ImageCodec* gdcm::JPEG2000Codec::Clone ( ) const [override], [virtual]
```

Implements [gdcm::ImageCodec](#).

### 10.170.3.6 Code()

```
bool gdcm::JPEG2000Codec::Code (
    DataElement const & in_,
    DataElement & out_ ) [override], [virtual]
```

Code.

Reimplemented from [gdcm::Coder](#).

### 10.170.3.7 Decode()

```
bool gdcm::JPEG2000Codec::Decode (
    DataElement const & ,
    DataElement & ) [override], [virtual]
```

Decode.

Reimplemented from [gdcm::ImageCodec](#).

### 10.170.3.8 DecodeByStreams()

```
bool gdcm::JPEG2000Codec::DecodeByStreams (
    std::istream & is,
    std::ostream & os ) [override], [protected], [virtual]
```

Reimplemented from [gdcm::ImageCodec](#).

### 10.170.3.9 DecodeExtent()

```
bool gdcm::JPEG2000Codec::DecodeExtent (
    char * buffer,
    unsigned int xmin,
    unsigned int xmax,
    unsigned int ymin,
    unsigned int ymax,
    unsigned int zmin,
    unsigned int zmax,
    std::istream & is ) [protected]
```

### 10.170.3.10 GetHeaderInfo()

```
bool gdcm::JPEG2000Codec::GetHeaderInfo (
    std::istream & is,
    TransferSyntax & ts ) [override], [virtual]
```

Reimplemented from [gdcm::ImageCodec](#).

### 10.170.3.11 GetQuality()

```
double gdcm::JPEG2000Codec::GetQuality (
    unsigned int idx = 0 ) const
```

### 10.170.3.12 GetRate()

```
double gdcm::JPEG2000Codec::GetRate (
    unsigned int idx = 0 ) const
```

### 10.170.3.13 IsFrameEncoder()

```
bool gdcm::JPEG2000Codec::IsFrameEncoder ( ) [override], [protected], [virtual]
```

Reimplemented from [gdcm::ImageCodec](#).

### 10.170.3.14 IsRowEncoder()

```
bool gdcm::JPEG2000Codec::IsRowEncoder ( ) [override], [protected], [virtual]
```

Reimplemented from [gdcm::ImageCodec](#).

### 10.170.3.15 SetMCT()

```
void gdcm::JPEG2000Codec::SetMCT (
    unsigned int mct )
```

### 10.170.3.16 SetNumberOfResolutions()

```
void gdcm::JPEG2000Codec::SetNumberOfResolutions (
    unsigned int nres )
```

### 10.170.3.17 SetNumberOfThreadsForDecompression()

```
void gdcm::JPEG2000Codec::SetNumberOfThreadsForDecompression (
    int nThreads )
```

Set Number of threads

## Parameters

<i>nThreads</i>	: number of threads for decompression codec, if 0 or 1 decompression is done in current thread, if negative value is set determine how many virtual threads are available
-----------------	---

**10.170.3.18 SetQuality()**

```
void gdcM::JPEG2000Codec::SetQuality (
    unsigned int idx,
    double q )
```

**10.170.3.19 SetRate()**

```
void gdcM::JPEG2000Codec::SetRate (
    unsigned int idx,
    double rate )
```

**10.170.3.20 SetReversible()**

```
void gdcM::JPEG2000Codec::SetReversible (
    bool res )
```

**10.170.3.21 SetTileSize()**

```
void gdcM::JPEG2000Codec::SetTileSize (
    unsigned int tx,
    unsigned int ty )
```

**10.170.3.22 StartEncode()**

```
bool gdcM::JPEG2000Codec::StartEncode (
    std::ostream & ) [override], [protected], [virtual]
```

Reimplemented from [gdcM::ImageCodec](#).



### 10.170.3.23 StopEncode()

```
bool gdcm::JPEG2000Codec::StopEncode (
    std::ostream & ) [override], [protected], [virtual]
```

Reimplemented from [gdcm::ImageCodec](#).

## 10.170.4 Friends And Related Function Documentation

### 10.170.4.1 Bitmap

```
friend class Bitmap [friend]
```

### 10.170.4.2 ImageRegionReader

```
friend class ImageRegionReader [friend]
```

The documentation for this class was generated from the following file:

- [gdcmJPEG2000Codec.h](#)

## 10.171 gdcm::JPEG8Codec Class Reference

Class to do JPEG 8bits (lossy & lossless)

```
#include <gdcmJPEG8Codec.h>
```

Inheritance diagram for `gdcm::JPEG8Codec`:

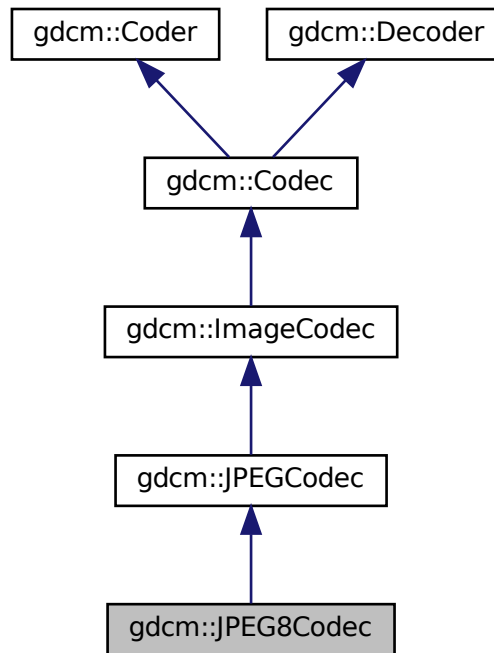

Collaboration diagram for `gdcm::JPEG8Codec`:

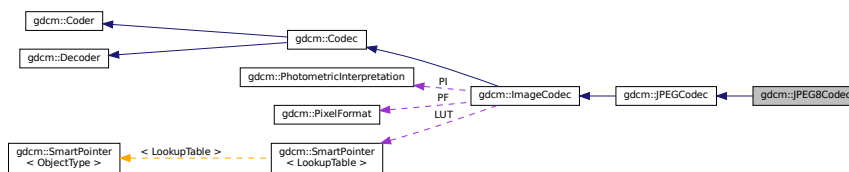

## Public Member Functions

- `JPEG8Codec` ()
- `~JPEG8Codec` () override
- `bool DecodeByStreams` (std::istream &is, std::ostream &os) override
- `bool GetHeaderInfo` (std::istream &is, `TransferSyntax` &ts) override
- `bool InternalCode` (const char \*input, unsigned long len, std::ostream &os) override

## Protected Member Functions

- bool [EncodeBuffer](#) (std::ostream &os, const char \*data, size\_t datalen) override
- bool [IsStateSuspension](#) () const override

## Additional Inherited Members

### 10.171.1 Detailed Description

Class to do JPEG 8bits (lossy & lossless)

#### Note

internal class

### 10.171.2 Constructor & Destructor Documentation

#### 10.171.2.1 JPEG8Codec()

```
gdcm::JPEG8Codec::JPEG8Codec ( )
```

#### 10.171.2.2 ~JPEG8Codec()

```
gdcm::JPEG8Codec::~~JPEG8Codec ( ) [override]
```

### 10.171.3 Member Function Documentation

#### 10.171.3.1 DecodeByStreams()

```
bool gdcm::JPEG8Codec::DecodeByStreams (
    std::istream & is,
    std::ostream & os ) [override], [virtual]
```

Reimplemented from [gdcm::ImageCodec](#).

### 10.171.3.2 EncodeBuffer()

```
bool gdcM::JPEG8Codec::EncodeBuffer (
    std::ostream & os,
    const char * data,
    size_t dataLen ) [override], [protected], [virtual]
```

Reimplemented from [gdcM::JPEGCodec](#).

### 10.171.3.3 GetHeaderInfo()

```
bool gdcM::JPEG8Codec::GetHeaderInfo (
    std::istream & is,
    TransferSyntax & ts ) [override], [virtual]
```

Reimplemented from [gdcM::ImageCodec](#).

### 10.171.3.4 InternalCode()

```
bool gdcM::JPEG8Codec::InternalCode (
    const char * input,
    unsigned long len,
    std::ostream & os ) [override], [virtual]
```

Reimplemented from [gdcM::Coder](#).

### 10.171.3.5 IsStateSuspension()

```
bool gdcM::JPEG8Codec::IsStateSuspension ( ) const [override], [protected], [virtual]
```

Reimplemented from [gdcM::JPEGCodec](#).

The documentation for this class was generated from the following file:

- [gdcMJPEG8Codec.h](#)

## 10.172 gdcm::JPEGCodec Class Reference

JPEG codec.

```
#include <gdcmJPEGCodec.h>
```

Inheritance diagram for gdcm::JPEGCodec:

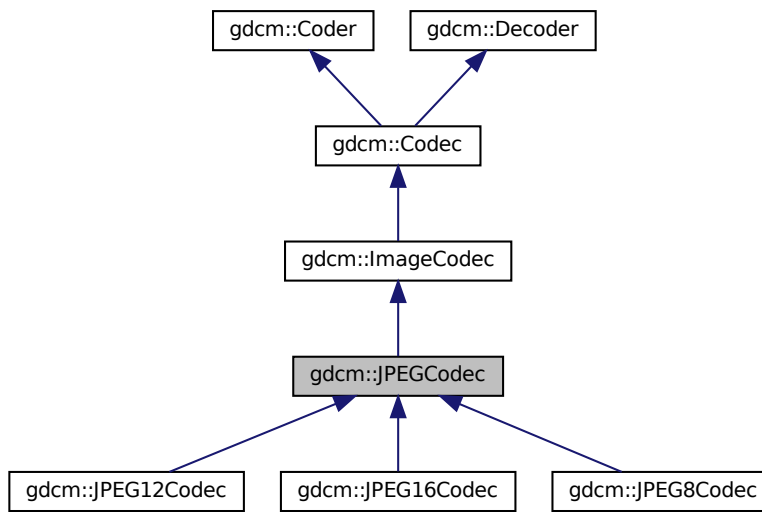

Collaboration diagram for gdcm::JPEGCodec:

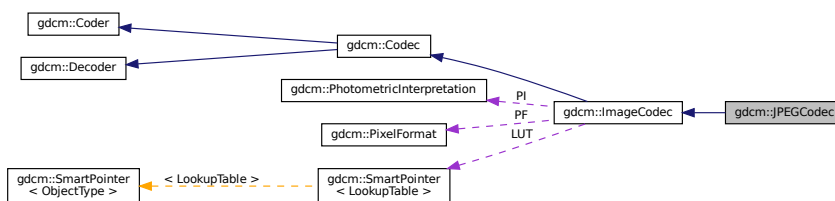

### Public Member Functions

- [JPEGCodec](#) ()
- [~JPEGCodec](#) () override
- bool [CanCode](#) ([TransferSyntax](#) const &ts) const override  
*Return whether this coder support this transfer syntax (can code it)*
- bool [CanDecode](#) ([TransferSyntax](#) const &ts) const override

*Return whether this decoder support this transfer syntax (can decode it)*

- [ImageCodec](#) \* [Clone](#) () const override
- bool [Code](#) ([DataElement](#) const &in, [DataElement](#) &out) override

*Compress into JPEG.*

- void [ComputeOffsetTable](#) (bool b)

*Compute the offset table:*

- bool [Decode](#) ([DataElement](#) const &is, [DataElement](#) &os) override

*Decode.*

- virtual bool [EncodeBuffer](#) (std::ostream &out, const char \*inbuffer, size\_t inlen)
- bool [GetHeaderInfo](#) (std::istream &is, [TransferSyntax](#) &ts) override
- bool [GetLossless](#) () const
- double [GetQuality](#) () const
- void [SetLossless](#) (bool l)
- void [SetPixelFormat](#) ([PixelFormat](#) const &pf) override
- void [SetQuality](#) (double q)

## Protected Member Functions

- bool [AppendFrameEncode](#) (std::ostream &out, const char \*data, size\_t datalen) override
- bool [AppendRowEncode](#) (std::ostream &out, const char \*data, size\_t datalen) override
- bool [DecodeByStreams](#) (std::istream &is, std::ostream &os) override
- bool [DecodeExtent](#) (char \*buffer, unsigned int xmin, unsigned int xmax, unsigned int ymin, unsigned int ymax, unsigned int zmin, unsigned int zmax, std::istream &is)
- bool [IsFrameEncoder](#) () override
- bool [IsRowEncoder](#) () override
- virtual bool [IsStateSuspension](#) () const
- bool [IsValid](#) ([PhotometricInterpretation](#) const &pi) override
- void [SetBitSample](#) (int bit)
- bool [StartEncode](#) (std::ostream &) override
- bool [StopEncode](#) (std::ostream &) override

## Protected Attributes

- int [BitSample](#)
- int [Quality](#)

## Friends

- class [ImageRegionReader](#)

## Additional Inherited Members

### 10.172.1 Detailed Description

JPEG codec.

Class to do JPEG (8bits, 12bits, 16bits lossy & lossless). It redispach in between the different codec implementation: [JPEG8Codec](#), [JPEG12Codec](#) & [JPEG16Codec](#) It also support inconsistency in between DICOM header and JPEG compressed stream [ImageCodec](#) implementation for the JPEG case

#### Note

Things you should know if you ever want to dive into DICOM/JPEG world (among other):

- [http://groups.google.com/group/comp.protocols.dicom/browse\\_thread/thread/625e46919f200](http://groups.google.com/group/comp.protocols.dicom/browse_thread/thread/625e46919f200)
- [http://groups.google.com/group/comp.protocols.dicom/browse\\_thread/thread/75fdfccc65a62](http://groups.google.com/group/comp.protocols.dicom/browse_thread/thread/75fdfccc65a62)
- [http://groups.google.com/group/comp.protocols.dicom/browse\\_thread/thread/2d525ef6a2f0](http://groups.google.com/group/comp.protocols.dicom/browse_thread/thread/2d525ef6a2f0)
- [http://groups.google.com/group/comp.protocols.dicom/browse\\_thread/thread/6b93af410f8c](http://groups.google.com/group/comp.protocols.dicom/browse_thread/thread/6b93af410f8c)

#### Examples

[GetJPEGSamplePrecision.cxx](#).

### 10.172.2 Constructor & Destructor Documentation

#### 10.172.2.1 JPEGCodec()

```
gdcm::JPEGCodec::JPEGCodec ( )
```

#### 10.172.2.2 ~JPEGCodec()

```
gdcm::JPEGCodec::~~JPEGCodec ( ) [override]
```

### 10.172.3 Member Function Documentation

### 10.172.3.1 AppendFrameEncode()

```
bool gdcM::JPEGCodec::AppendFrameEncode (
    std::ostream & out,
    const char * data,
    size_t datalen ) [override], [protected], [virtual]
```

Reimplemented from [gdcM::ImageCodec](#).

### 10.172.3.2 AppendRowEncode()

```
bool gdcM::JPEGCodec::AppendRowEncode (
    std::ostream & out,
    const char * data,
    size_t datalen ) [override], [protected], [virtual]
```

Reimplemented from [gdcM::ImageCodec](#).

### 10.172.3.3 CanCode()

```
bool gdcM::JPEGCodec::CanCode (
    TransferSyntax const & ) const [override], [virtual]
```

Return whether this coder support this transfer syntax (can code it)

Reimplemented from [gdcM::ImageCodec](#).

### 10.172.3.4 CanDecode()

```
bool gdcM::JPEGCodec::CanDecode (
    TransferSyntax const & ) const [override], [virtual]
```

Return whether this decoder support this transfer syntax (can decode it)

Reimplemented from [gdcM::ImageCodec](#).



### 10.172.3.5 Clone()

```
ImageCodec* gdcm::JPEGCodec::Clone ( ) const [override], [virtual]
```

Implements [gdcm::ImageCodec](#).

### 10.172.3.6 Code()

```
bool gdcm::JPEGCodec::Code (
    DataElement const & in,
    DataElement & out ) [override], [virtual]
```

Compress into JPEG.

Reimplemented from [gdcm::Coder](#).

### 10.172.3.7 ComputeOffsetTable()

```
void gdcm::JPEGCodec::ComputeOffsetTable (
    bool b )
```

Compute the offset table:

### 10.172.3.8 Decode()

```
bool gdcm::JPEGCodec::Decode (
    DataElement const & ,
    DataElement & ) [override], [virtual]
```

Decode.

Reimplemented from [gdcm::ImageCodec](#).

### 10.172.3.9 DecodeByStreams()

```
bool gdcm::JPEGCodec::DecodeByStreams (
    std::istream & is,
    std::ostream & os ) [override], [protected], [virtual]
```

Reimplemented from [gdcm::ImageCodec](#).

### 10.172.3.10 DecodeExtent()

```
bool gdcM::JPEGCodec::DecodeExtent (
    char * buffer,
    unsigned int xmin,
    unsigned int xmax,
    unsigned int ymin,
    unsigned int ymax,
    unsigned int zmin,
    unsigned int zmax,
    std::istream & is ) [protected]
```

### 10.172.3.11 EncodeBuffer()

```
virtual bool gdcM::JPEGCodec::EncodeBuffer (
    std::ostream & out,
    const char * inbuffer,
    size_t inlen ) [virtual]
```

Reimplemented in [gdcM::JPEG8Codec](#), [gdcM::JPEG16Codec](#), and [gdcM::JPEG12Codec](#).

### 10.172.3.12 GetHeaderInfo()

```
bool gdcM::JPEGCodec::GetHeaderInfo (
    std::istream & is,
    TransferSyntax & ts ) [override], [virtual]
```

Reimplemented from [gdcM::ImageCodec](#).

#### Examples

[GetJPEGSamplePrecision.cxx](#).

### 10.172.3.13 GetLossless()

```
bool gdcM::JPEGCodec::GetLossless ( ) const
```

### 10.172.3.14 GetQuality()

```
double gdcm::JPEGCodec::GetQuality ( ) const
```

### 10.172.3.15 IsFrameEncoder()

```
bool gdcm::JPEGCodec::IsFrameEncoder ( ) [override], [protected], [virtual]
```

Reimplemented from [gdcm::ImageCodec](#).

### 10.172.3.16 IsRowEncoder()

```
bool gdcm::JPEGCodec::IsRowEncoder ( ) [override], [protected], [virtual]
```

Reimplemented from [gdcm::ImageCodec](#).

### 10.172.3.17 IsStateSuspension()

```
virtual bool gdcm::JPEGCodec::IsStateSuspension ( ) const [protected], [virtual]
```

Reimplemented in [gdcm::JPEG8Codec](#), [gdcm::JPEG16Codec](#), and [gdcm::JPEG12Codec](#).

### 10.172.3.18 IsValid()

```
bool gdcm::JPEGCodec::IsValid (
    PhotometricInterpretation const & pi ) [override], [protected], [virtual]
```

Reimplemented from [gdcm::ImageCodec](#).

### 10.172.3.19 SetBitSample()

```
void gdcm::JPEGCodec::SetBitSample (
    int bit ) [protected]
```

### 10.172.3.20 SetLossless()

```
void gdcM::JPEGCodec::SetLossless (
    bool l )
```

### 10.172.3.21 SetPixelFormat()

```
void gdcM::JPEGCodec::SetPixelFormat (
    PixelFormat const & pf ) [override], [virtual]
```

Reimplemented from [gdcM::ImageCodec](#).

#### Examples

[GetJPEGSamplePrecision.cxx](#).

### 10.172.3.22 SetQuality()

```
void gdcM::JPEGCodec::SetQuality (
    double q )
```

### 10.172.3.23 StartEncode()

```
bool gdcM::JPEGCodec::StartEncode (
    std::ostream & ) [override], [protected], [virtual]
```

Reimplemented from [gdcM::ImageCodec](#).

### 10.172.3.24 StopEncode()

```
bool gdcM::JPEGCodec::StopEncode (
    std::ostream & ) [override], [protected], [virtual]
```

Reimplemented from [gdcM::ImageCodec](#).

## 10.172.4 Friends And Related Function Documentation

### 10.172.4.1 ImageRegionReader

```
friend class ImageRegionReader [friend]
```

## 10.172.5 Member Data Documentation

### 10.172.5.1 BitSample

```
int gdcm::JPEGCodec::BitSample [protected]
```

### 10.172.5.2 Quality

```
int gdcm::JPEGCodec::Quality [protected]
```

The documentation for this class was generated from the following file:

- [gdcmJPEGCodec.h](#)

## 10.173 gdcm::JPEGCodec Class Reference

JPEG-LS.

```
#include <gdcmJPEGCodec.h>
```

Inheritance diagram for `gdcm::JPEGLSCodec`:

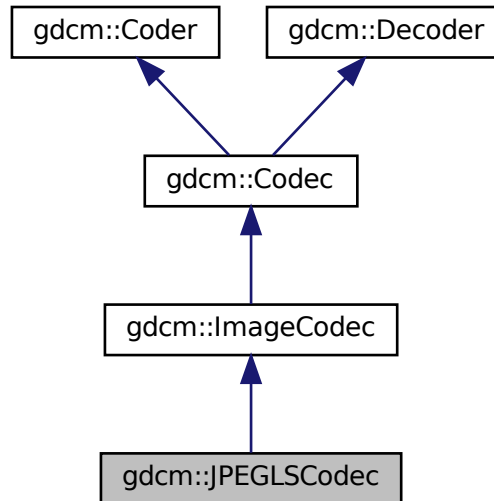

Collaboration diagram for `gdcm::JPEGLSCodec`:

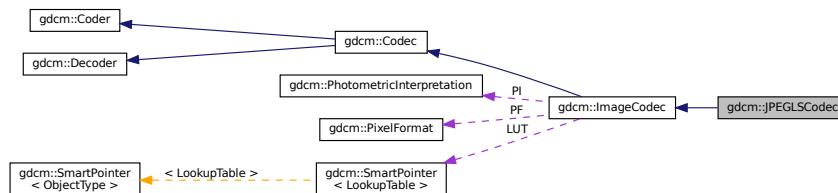

## Public Member Functions

- [JPEGLSCodec](#) ()
- [~JPEGLSCodec](#) () override
- bool [CanCode](#) ([TransferSyntax](#) const &ts) const override  
*Return whether this coder support this transfer syntax (can code it)*
- bool [CanDecode](#) ([TransferSyntax](#) const &ts) const override  
*Return whether this decoder support this transfer syntax (can decode it)*
- [ImageCodec](#) \* [Clone](#) () const override
- bool [Code](#) ([DataElement](#) const &in, [DataElement](#) &out) override  
*Code.*

- bool [Decode](#) ([DataElement](#) const &in, char \*outBuffer, size\_t inBufferLength, uint32\_t inXMin, uint32\_t inXMax, uint32\_t inYMin, uint32\_t inYMax, uint32\_t inZMin, uint32\_t inZMax)
- bool [Decode](#) ([DataElement](#) const &is, [DataElement](#) &os) override  
*Decode.*
- unsigned long [GetBufferLength](#) () const
- bool [GetHeaderInfo](#) (std::istream &is, [TransferSyntax](#) &ts) override
- bool [GetLossless](#) () const
- void [SetBufferLength](#) (unsigned long l)
- void [SetLossless](#) (bool l)
- void [SetLossyError](#) (int error)  
*[0-3] generally*

## Protected Member Functions

- bool [AppendFrameEncode](#) (std::ostream &out, const char \*data, size\_t datalen) override
- bool [AppendRowEncode](#) (std::ostream &out, const char \*data, size\_t datalen) override
- bool [DecodeExtent](#) (char \*buffer, unsigned int xmin, unsigned int xmax, unsigned int ymin, unsigned int ymax, unsigned int zmin, unsigned int zmax, std::istream &is)
- bool [IsFrameEncoder](#) () override
- bool [IsRowEncoder](#) () override
- bool [StartEncode](#) (std::ostream &) override
- bool [StopEncode](#) (std::ostream &) override

## Friends

- class [ImageRegionReader](#)

## Additional Inherited Members

### 10.173.1 Detailed Description

JPEG-LS.

#### Note

codec that implement the JPEG-LS compression this is an implementation of [ImageCodec](#) for JPEG-LS

It uses the CharLS JPEG-LS implementation <https://github.com/team-charls/charls>

### 10.173.2 Constructor & Destructor Documentation

### 10.173.2.1 JPEGLSCodec()

```
gdcm::JPEGLSCodec::JPEGLSCodec ( )
```

### 10.173.2.2 ~JPEGLSCodec()

```
gdcm::JPEGLSCodec::~~JPEGLSCodec ( ) [override]
```

## 10.173.3 Member Function Documentation

### 10.173.3.1 AppendFrameEncode()

```
bool gdcm::JPEGLSCodec::AppendFrameEncode (
    std::ostream & out,
    const char * data,
    size_t datalen ) [override], [protected], [virtual]
```

Reimplemented from [gdcm::ImageCodec](#).

### 10.173.3.2 AppendRowEncode()

```
bool gdcm::JPEGLSCodec::AppendRowEncode (
    std::ostream & out,
    const char * data,
    size_t datalen ) [override], [protected], [virtual]
```

Reimplemented from [gdcm::ImageCodec](#).

### 10.173.3.3 CanCode()

```
bool gdcm::JPEGLSCodec::CanCode (
    TransferSyntax const & ) const [override], [virtual]
```

Return whether this coder support this transfer syntax (can code it)

Reimplemented from [gdcm::ImageCodec](#).



### 10.173.3.4 CanDecode()

```
bool gdcM::JPEGLSCodec::CanDecode (
    TransferSyntax const & ) const [override], [virtual]
```

Return whether this decoder support this transfer syntax (can decode it)

Reimplemented from [gdcM::ImageCodec](#).

### 10.173.3.5 Clone()

```
ImageCodec* gdcM::JPEGLSCodec::Clone ( ) const [override], [virtual]
```

Implements [gdcM::ImageCodec](#).

### 10.173.3.6 Code()

```
bool gdcM::JPEGLSCodec::Code (
    DataElement const & in_,
    DataElement & out_ ) [override], [virtual]
```

Code.

Reimplemented from [gdcM::Coder](#).

### 10.173.3.7 Decode() [1/2]

```
bool gdcM::JPEGLSCodec::Decode (
    DataElement const & in,
    char * outBuffer,
    size_t inBufferLength,
    uint32_t inXMin,
    uint32_t inXMax,
    uint32_t inYMin,
    uint32_t inYMax,
    uint32_t inZMin,
    uint32_t inZMax )
```

### 10.173.3.8 Decode() [2/2]

```
bool gdcM::JPEGLSCodec::Decode (
    DataElement const & ,
    DataElement & ) [override], [virtual]
```

Decode.

Reimplemented from [gdcM::ImageCodec](#).

### 10.173.3.9 DecodeExtent()

```
bool gdcM::JPEGLSCodec::DecodeExtent (
    char * buffer,
    unsigned int xmin,
    unsigned int xmax,
    unsigned int ymin,
    unsigned int ymax,
    unsigned int zmin,
    unsigned int zmax,
    std::istream & is ) [protected]
```

### 10.173.3.10 GetBufferLength()

```
unsigned long gdcM::JPEGLSCodec::GetBufferLength ( ) const [inline]
```

### 10.173.3.11 GetHeaderInfo()

```
bool gdcM::JPEGLSCodec::GetHeaderInfo (
    std::istream & is,
    TransferSyntax & ts ) [override], [virtual]
```

Reimplemented from [gdcM::ImageCodec](#).

### 10.173.3.12 GetLossless()

```
bool gdcM::JPEGLSCodec::GetLossless ( ) const
```

### 10.173.3.13 IsFrameEncoder()

```
bool gdcm::JPEGLSCodec::IsFrameEncoder ( ) [override], [protected], [virtual]
```

Reimplemented from [gdcm::ImageCodec](#).

### 10.173.3.14 IsRowEncoder()

```
bool gdcm::JPEGLSCodec::IsRowEncoder ( ) [override], [protected], [virtual]
```

Reimplemented from [gdcm::ImageCodec](#).

### 10.173.3.15 SetBufferLength()

```
void gdcm::JPEGLSCodec::SetBufferLength (
    unsigned long l ) [inline]
```

### 10.173.3.16 SetLossless()

```
void gdcm::JPEGLSCodec::SetLossless (
    bool l )
```

### 10.173.3.17 SetLossyError()

```
void gdcm::JPEGLSCodec::SetLossyError (
    int error )
```

[0-3] generally

### 10.173.3.18 StartEncode()

```
bool gdcm::JPEGLSCodec::StartEncode (
    std::ostream & ) [override], [protected], [virtual]
```

Reimplemented from [gdcm::ImageCodec](#).

### 10.173.3.19 StopEncode()

```
bool gdcm::JPEGLSCodec::StopEncode (
    std::ostream & ) [override], [protected], [virtual]
```

Reimplemented from [gdcm::ImageCodec](#).

## 10.173.4 Friends And Related Function Documentation

### 10.173.4.1 ImageRegionReader

```
friend class ImageRegionReader [friend]
```

The documentation for this class was generated from the following file:

- [gdcmJPEGLSCodec.h](#)

## 10.174 gdcm::JSON Class Reference

```
#include <gdcmJSON.h>
```

### Public Member Functions

- [JSON](#) ()
- [~JSON](#) ()
- bool [Code](#) ([DataSet](#) const &in, std::ostream &os)
- bool [Decode](#) (std::istream &is, [DataSet](#) &out)
- bool [GetPrettyPrint](#) () const
- void [PrettyPrintOff](#) ()
- void [PrettyPrintOn](#) ()
- void [SetPrettyPrint](#) (bool onoff)

### 10.174.1 Detailed Description

Examples

[QIDO-RS.cxx](#).

### 10.174.2 Constructor & Destructor Documentation

### 10.174.2.1 JSON()

```
gdcM::JSON::JSON ( )
```

### 10.174.2.2 ~JSON()

```
gdcM::JSON::~~JSON ( )
```

## 10.174.3 Member Function Documentation

### 10.174.3.1 Code()

```
bool gdcM::JSON::Code (
    DataSet const & in,
    std::ostream & os )
```

#### Examples

[QIDO-RS.cxx](#).

### 10.174.3.2 Decode()

```
bool gdcM::JSON::Decode (
    std::istream & is,
    DataSet & out )
```

#### Examples

[QIDO-RS.cxx](#).

### 10.174.3.3 GetPrettyPrint()

```
bool gdcM::JSON::GetPrettyPrint ( ) const
```

#### 10.174.3.4 PrettyPrintOff()

```
void gdcM::JSON::PrettyPrintOff ( )
```

#### 10.174.3.5 PrettyPrintOn()

```
void gdcM::JSON::PrettyPrintOn ( )
```

#### Examples

[QIDO-RS.cxx](#).

#### 10.174.3.6 SetPrettyPrint()

```
void gdcM::JSON::SetPrettyPrint (
    bool onoff )
```

The documentation for this class was generated from the following file:

- [gdcMJSON.h](#)

## 10.175 gdcM::KAKADUCodec Class Reference

[KAKADUCodec](#).

```
#include <gdcMKAKADUCodec.h>
```

Inheritance diagram for gdcm::KAKADUCodec:

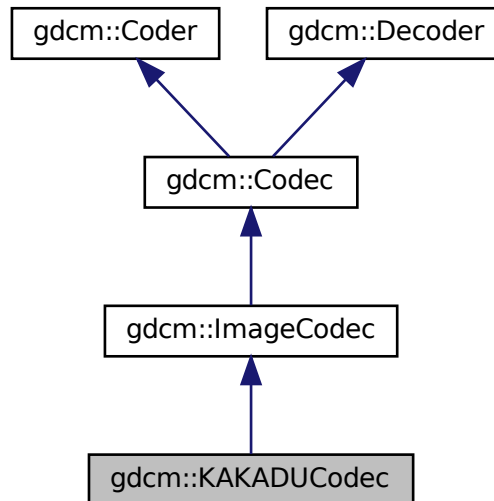

Collaboration diagram for gdcm::KAKADUCodec:

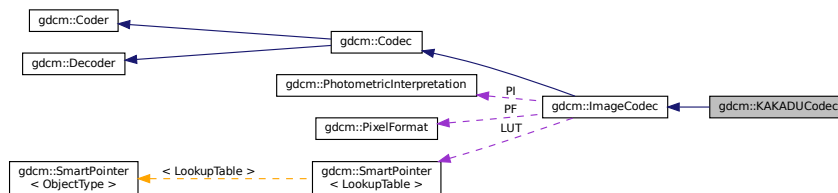

## Public Member Functions

- [KAKADUCodec \(\)](#)
- [~KAKADUCodec \(\)](#) override
- bool [CanCode \(TransferSyntax const &ts\)](#) const override  
*Return whether this coder support this transfer syntax (can code it)*
- bool [CanDecode \(TransferSyntax const &ts\)](#) const override  
*Return whether this decoder support this transfer syntax (can decode it)*
- [ImageCodec \\* Clone \(\)](#) const override
- bool [Code \(DataElement const &in, DataElement &out\)](#) override  
*Code.*
- bool [Decode \(DataElement const &is, DataElement &os\)](#) override  
*Decode.*

## Additional Inherited Members

### 10.175.1 Detailed Description

[KAKADUCodec](#).

### 10.175.2 Constructor & Destructor Documentation

#### 10.175.2.1 KAKADUCodec()

```
gdcm::KAKADUCodec::KAKADUCodec ( )
```

#### 10.175.2.2 ~KAKADUCodec()

```
gdcm::KAKADUCodec::~~KAKADUCodec ( ) [override]
```

### 10.175.3 Member Function Documentation

#### 10.175.3.1 CanCode()

```
bool gdcm::KAKADUCodec::CanCode (
    TransferSyntax const & ) const [override], [virtual]
```

Return whether this coder support this transfer syntax (can code it)

Reimplemented from [gdcm::ImageCodec](#).

#### 10.175.3.2 CanDecode()

```
bool gdcm::KAKADUCodec::CanDecode (
    TransferSyntax const & ) const [override], [virtual]
```

Return whether this decoder support this transfer syntax (can decode it)

Reimplemented from [gdcm::ImageCodec](#).



### 10.175.3.3 Clone()

```
ImageCodec* gdcm::KAKADUCodec::Clone ( ) const [override], [virtual]
```

Implements [gdcm::ImageCodec](#).

### 10.175.3.4 Code()

```
bool gdcm::KAKADUCodec::Code (
    DataElement const & in_,
    DataElement & out_ ) [override], [virtual]
```

Code.

Reimplemented from [gdcm::Coder](#).

### 10.175.3.5 Decode()

```
bool gdcm::KAKADUCodec::Decode (
    DataElement const & ,
    DataElement & ) [override], [virtual]
```

Decode.

Reimplemented from [gdcm::ImageCodec](#).

The documentation for this class was generated from the following file:

- [gdcmKAKADUCodec.h](#)

## 10.176 gdcM::LO Class Reference

[LO](#).

```
#include <gdcMLO.h>
```

Inheritance diagram for gdcM::LO:

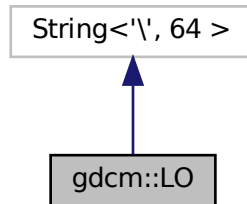

Collaboration diagram for gdcM::LO:

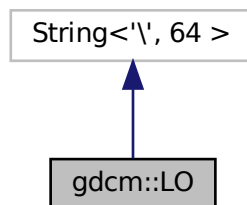

### Public Types

- typedef `Superclass::const_iterator` `const_iterator`
- typedef `Superclass::const_reference` `const_reference`
- typedef `Superclass::const_reverse_iterator` `const_reverse_iterator`
- typedef `Superclass::difference_type` `difference_type`
- typedef `Superclass::iterator` `iterator`
- typedef `Superclass::pointer` `pointer`
- typedef `Superclass::reference` `reference`
- typedef `Superclass::reverse_iterator` `reverse_iterator`
- typedef `Superclass::size_type` `size_type`
- typedef `String<'\\', 64 >` `Superclass`
- typedef `Superclass::value_type` `value_type`

## Public Member Functions

- [LO](#) ()
- [LO](#) (const [Superclass](#) &s, [size\\_type](#) pos=0, [size\\_type](#) n=npos)
- [LO](#) (const [value\\_type](#) \*s)
- [LO](#) (const [value\\_type](#) \*s, [size\\_type](#) n)
- bool [IsValid](#) () const

### 10.176.1 Detailed Description

[LO](#).

Note

TODO

### 10.176.2 Member Typedef Documentation

#### 10.176.2.1 `const_iterator`

```
typedef Superclass::const\_iterator gdcm::LO::const_iterator
```

#### 10.176.2.2 `const_reference`

```
typedef Superclass::const\_reference gdcm::LO::const_reference
```

#### 10.176.2.3 `const_reverse_iterator`

```
typedef Superclass::const\_reverse\_iterator gdcm::LO::const_reverse_iterator
```

#### 10.176.2.4 `difference_type`

```
typedef Superclass::difference\_type gdcm::LO::difference_type
```

**10.176.2.5 iterator**

```
typedef Superclass::iterator gdcM::LO::iterator
```

**10.176.2.6 pointer**

```
typedef Superclass::pointer gdcM::LO::pointer
```

**10.176.2.7 reference**

```
typedef Superclass::reference gdcM::LO::reference
```

**10.176.2.8 reverse\_iterator**

```
typedef Superclass::reverse_iterator gdcM::LO::reverse_iterator
```

**10.176.2.9 size\_type**

```
typedef Superclass::size_type gdcM::LO::size_type
```

**10.176.2.10 Superclass**

```
typedef String<'\\', 64> gdcM::LO::Superclass
```

**10.176.2.11 value\_type**

```
typedef Superclass::value_type gdcM::LO::value_type
```

## 10.176.3 Constructor & Destructor Documentation

### 10.176.3.1 LO() [1/4]

```
gdcmm::LO::LO ( ) [inline]
```

### 10.176.3.2 LO() [2/4]

```
gdcmm::LO::LO (
    const value\_type * s ) [inline]
```

### 10.176.3.3 LO() [3/4]

```
gdcmm::LO::LO (
    const value\_type * s,
    size\_type n ) [inline]
```

### 10.176.3.4 LO() [4/4]

```
gdcmm::LO::LO (
    const Superclass & s,
    size\_type pos = 0,
    size\_type n = npos ) [inline]
```

## 10.176.4 Member Function Documentation

### 10.176.4.1 IsValid()

```
bool gdcmm::LO::IsValid ( ) const [inline]
```

References [gdcmm::String< TDelimiter, TMaxLength, TPadChar >::IsValid\(\)](#).

The documentation for this class was generated from the following file:

- [gdcmmLO.h](#)

## 10.177 gdcm::LookupTable Class Reference

[LookupTable](#) class.

```
#include <gdcmLookupTable.h>
```

Inheritance diagram for gdcm::LookupTable:

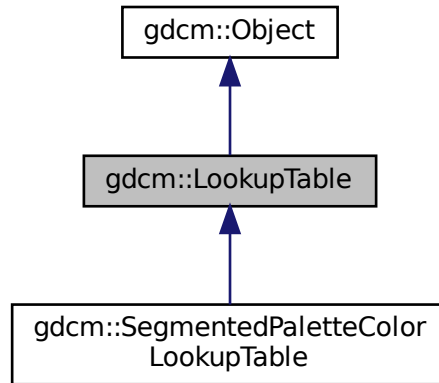

Collaboration diagram for gdcm::LookupTable:

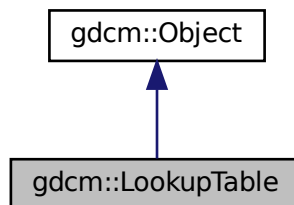

### Public Types

- enum `LookupTableType` {  
    `RED = 0` ,  
    `GREEN` ,  
    `BLUE` ,  
    `GRAY` ,  
    `UNKNOWN` }

## Public Member Functions

- [LookupTable](#) ()
- [LookupTable](#) ([LookupTable](#) const &lut)
- [~LookupTable](#) () override
- void [Allocate](#) (unsigned short bitsample=8)  
*Allocate the LUT.*
- void [Clear](#) ()  
*Clear the LUT.*
- bool [Decode](#) (char \*outputbuffer, size\_t outlen, const char \*inputbuffer, size\_t inlen) const
- void [Decode](#) (std::istream &is, std::ostream &os) const  
*Decode the LUT.*
- bool [Decode8](#) (char \*outputbuffer, size\_t outlen, const char \*inputbuffer, size\_t inlen) const  
*Decode into RGB 8 bits space.*
- unsigned short [GetBitSample](#) () const  
*return the bit sample*
- bool [GetBufferAsRGBA](#) (unsigned char \*rgba) const  
*return the LUT as RGBA buffer*
- void [GetLUT](#) ([LookupTableType](#) type, unsigned char \*array, unsigned int &length) const
- void [GetLUTDescriptor](#) ([LookupTableType](#) type, unsigned short &length, unsigned short &subscript, unsigned short &bitsize) const
- unsigned int [GetLUTLength](#) ([LookupTableType](#) type) const
- const unsigned char \* [GetPointer](#) () const  
*return a raw pointer to the LUT*
- void [InitializeBlueLUT](#) (unsigned short length, unsigned short subscript, unsigned short bitsize)
- bool [Initialized](#) () const  
*return whether the LUT has been initialized*
- void [InitializeGreenLUT](#) (unsigned short length, unsigned short subscript, unsigned short bitsize)
- void [InitializeLUT](#) ([LookupTableType](#) type, unsigned short length, unsigned short subscript, unsigned short bitsize)  
*Generic interface:*
- void [InitializeRedLUT](#) (unsigned short length, unsigned short subscript, unsigned short bitsize)  
*RED / GREEN / BLUE specific:*
- bool [IsRGB8](#) () const  
*Return whether 16 bits LUT is in RGB 8 bits space.*
- void [Print](#) (std::ostream &) const override
- void [SetBlueLUT](#) (const unsigned char \*blue, unsigned int length)
- void [SetGreenLUT](#) (const unsigned char \*green, unsigned int length)
- virtual void [SetLUT](#) ([LookupTableType](#) type, const unsigned char \*array, unsigned int length)
- void [SetRedLUT](#) (const unsigned char \*red, unsigned int length)
- bool [WriteBufferAsRGBA](#) (const unsigned char \*rgba)  
*Write the LUT as RGBA.*

## Protected Attributes

- unsigned short [BitSample](#)
- bool [IncompleteLUT](#):1
- [LookupTableInternal](#) \* [Internal](#)

## Additional Inherited Members

### 10.177.1 Detailed Description

[LookupTable](#) class.

Examples

[PrintLUT.cxx](#).

### 10.177.2 Member Enumeration Documentation

#### 10.177.2.1 LookupTableType

```
enum gdcM::LookupTable::LookupTableType
```

Enumerator

RED	
GREEN	
BLUE	
GRAY	
UNKNOWN	

### 10.177.3 Constructor & Destructor Documentation

#### 10.177.3.1 LookupTable() [1/2]

```
gdcM::LookupTable::LookupTable ( )
```

#### 10.177.3.2 ~LookupTable()

```
gdcM::LookupTable::~~LookupTable ( ) [override]
```



### 10.177.3.3 LookupTable() [2/2]

```
gdcmm::LookupTable::LookupTable (
    LookupTable const & lut ) [inline]
```

## 10.177.4 Member Function Documentation

### 10.177.4.1 Allocate()

```
void gdcmm::LookupTable::Allocate (
    unsigned short bitsample = 8 )
```

Allocate the LUT.

### 10.177.4.2 Clear()

```
void gdcmm::LookupTable::Clear ( )
```

Clear the LUT.

### 10.177.4.3 Decode() [1/2]

```
bool gdcmm::LookupTable::Decode (
    char * outputbuffer,
    size_t outlen,
    const char * inputbuffer,
    size_t inlen ) const
```

Decode the LUT outputbuffer will contains the RGB decoded PALETTE COLOR input image of size inlen the outputbuffer should be at least 3 times the size of inlen

### 10.177.4.4 Decode() [2/2]

```
void gdcmm::LookupTable::Decode (
    std::istream & is,
    std::ostream & os ) const
```

Decode the LUT.

#### 10.177.4.5 Decode8()

```
bool gdcM::LookupTable::Decode8 (
    char * outputbuffer,
    size_t outlen,
    const char * inputbuffer,
    size_t inlen ) const
```

Decode into RGB 8 bits space.

#### 10.177.4.6 GetBitSample()

```
unsigned short gdcM::LookupTable::GetBitSample ( ) const [inline]
```

return the bit sample

#### 10.177.4.7 GetBufferAsRGBA()

```
bool gdcM::LookupTable::GetBufferAsRGBA (
    unsigned char * rgba ) const
```

return the LUT as RGBA buffer

#### 10.177.4.8 GetLUT()

```
void gdcM::LookupTable::GetLUT (
    LookupTableType type,
    unsigned char * array,
    unsigned int & length ) const
```

#### Examples

[ExtractImageRegionWithLUT.cs](#).

#### 10.177.4.9 GetLUTDescriptor()

```
void gdcm::LookupTable::GetLUTDescriptor (
    LookupTableType type,
    unsigned short & length,
    unsigned short & subscript,
    unsigned short & bitsize ) const
```

#### 10.177.4.10 GetLUTLength()

```
unsigned int gdcm::LookupTable::GetLUTLength (
    LookupTableType type ) const
```

#### 10.177.4.11 GetPointer()

```
const unsigned char* gdcm::LookupTable::GetPointer ( ) const
```

return a raw pointer to the LUT

#### 10.177.4.12 InitializeBlueLUT()

```
void gdcm::LookupTable::InitializeBlueLUT (
    unsigned short length,
    unsigned short subscript,
    unsigned short bitsize )
```

#### 10.177.4.13 Initialized()

```
bool gdcm::LookupTable::Initialized ( ) const
```

return whether the LUT has been initialized

#### 10.177.4.14 InitializeGreenLUT()

```
void gdcm::LookupTable::InitializeGreenLUT (
    unsigned short length,
    unsigned short subscript,
    unsigned short bitsize )
```

#### 10.177.4.15 InitializeLUT()

```
void gdcm::LookupTable::InitializeLUT (
    LookupTableType type,
    unsigned short length,
    unsigned short subscript,
    unsigned short bitsize )
```

Generic interface:

#### 10.177.4.16 InitializeRedLUT()

```
void gdcm::LookupTable::InitializeRedLUT (
    unsigned short length,
    unsigned short subscript,
    unsigned short bitsize )
```

RED / GREEN / BLUE specific:

#### 10.177.4.17 IsRGB8()

```
bool gdcm::LookupTable::IsRGB8 ( ) const
```

Return whether 16 bits LUT is in RGB 8 bits space.

#### 10.177.4.18 Print()

```
void gdcm::LookupTable::Print (
    std::ostream & ) const [override], [virtual]
```

Reimplemented from [gdcm::Object](#).

Reimplemented in [gdcm::SegmentedPaletteColorLookupTable](#).

Examples

[PrintLUT.cxx](#).

#### 10.177.4.19 SetBlueLUT()

```
void gdcm::LookupTable::SetBlueLUT (
    const unsigned char * blue,
    unsigned int length )
```

#### 10.177.4.20 SetGreenLUT()

```
void gdcm::LookupTable::SetGreenLUT (
    const unsigned char * green,
    unsigned int length )
```

#### 10.177.4.21 SetLUT()

```
virtual void gdcm::LookupTable::SetLUT (
    LookupTableType type,
    const unsigned char * array,
    unsigned int length ) [virtual]
```

Reimplemented in [gdcm::SegmentedPaletteColorLookupTable](#).

#### 10.177.4.22 SetRedLUT()

```
void gdcm::LookupTable::SetRedLUT (
    const unsigned char * red,
    unsigned int length )
```

#### 10.177.4.23 WriteBufferAsRGBA()

```
bool gdcm::LookupTable::WriteBufferAsRGBA (
    const unsigned char * rgba )
```

Write the LUT as RGBA.

### 10.177.5 Member Data Documentation

### 10.177.5.1 BitSample

```
unsigned short gdcM::LookupTable::BitSample [protected]
```

### 10.177.5.2 IncompleteLUT

```
bool gdcM::LookupTable::IncompleteLUT [protected]
```

### 10.177.5.3 Internal

```
LookupTableInternal* gdcM::LookupTable::Internal [protected]
```

The documentation for this class was generated from the following file:

- [gdcMLookupTable.h](#)

## 10.178 gdcM::Scanner::ltstr Struct Reference

```
#include <gdcMScanner.h>
```

### Public Member Functions

- bool [operator\(\)](#) (const char \*s1, const char \*s2) const

### 10.178.1 Member Function Documentation

#### 10.178.1.1 operator()

```
bool gdcM::Scanner::ltstr::operator() (  
    const char * s1,  
    const char * s2 ) const [inline]
```

The documentation for this struct was generated from the following file:

- [gdcMScanner.h](#)

## 10.179 gdcm::StrictScanner::ltstr Struct Reference

```
#include <gdcmStrictScanner.h>
```

### Public Member Functions

- bool [operator\(\)](#) (const char \*s1, const char \*s2) const

### 10.179.1 Member Function Documentation

#### 10.179.1.1 operator()

```
bool gdcm::StrictScanner::ltstr::operator() (
    const char * s1,
    const char * s2 ) const [inline]
```

The documentation for this struct was generated from the following file:

- [gdcmStrictScanner.h](#)

## 10.180 gdcm::Macro Class Reference

Class for representing a [Macro](#).

```
#include <gdcmMacro.h>
```

### Public Types

- typedef std::vector< std::string > [ArrayIncludeMacrosType](#)
- typedef std::map< [Tag](#), [MacroEntry](#) > [MapModuleEntry](#)

### Public Member Functions

- [Macro](#) ()=default
- void [AddMacroEntry](#) (const [Tag](#) &tag, const [MacroEntry](#) &module)
  - Will add a [ModuleEntry](#) directly at root-level. See [Macro](#) for nested-included level.*
- void [Clear](#) ()
- bool [FindMacroEntry](#) (const [Tag](#) &tag) const
- const [MacroEntry](#) & [GetMacroEntry](#) (const [Tag](#) &tag) const
- const char \* [GetName](#) () const
- void [SetName](#) (const char \*name)
- bool [Verify](#) (const [DataSet](#) &ds, [Usage](#) const &usage) const

## Friends

- `std::ostream & operator<< (std::ostream &_os, const Macro &_val)`

### 10.180.1 Detailed Description

Class for representing a [Macro](#).

#### Note

[Attribute Macro](#): a set of Attributes that are described in a single table that is referenced by multiple [Module](#) or other tables.

#### See also

[Module](#)

### 10.180.2 Member Typedef Documentation

#### 10.180.2.1 `ArrayIncludeMacroType`

```
typedef std::vector<std::string> gdcmm::Macro::ArrayIncludeMacroType
```

#### 10.180.2.2 `MapModuleEntry`

```
typedef std::map<Tag, MacroEntry> gdcmm::Macro::MapModuleEntry
```

### 10.180.3 Constructor & Destructor Documentation

#### 10.180.3.1 `Macro()`

```
gdcmm::Macro::Macro ( ) [default]
```

### 10.180.4 Member Function Documentation



#### 10.180.4.1 AddMacroEntry()

```
void gdcmmacro::Macro::AddMacroEntry (
    const Tag & tag,
    const MacroEntry & module ) [inline]
```

Will add a [ModuleEntry](#) directly at root-level. See [Macro](#) for nested-included level.

#### 10.180.4.2 Clear()

```
void gdcmmacro::Macro::Clear ( ) [inline]
```

#### 10.180.4.3 FindMacroEntry()

```
bool gdcmmacro::Macro::FindMacroEntry (
    const Tag & tag ) const
```

Find or Get a [ModuleEntry](#). [ModuleEntry](#) are either search are root-level or within nested-macro included in module.

#### 10.180.4.4 GetMacroEntry()

```
const MacroEntry& gdcmmacro::Macro::GetMacroEntry (
    const Tag & tag ) const
```

#### 10.180.4.5 GetName()

```
const char* gdcmmacro::Macro::GetName ( ) const [inline]
```

#### 10.180.4.6 SetName()

```
void gdcmmacro::Macro::SetName (
    const char * name ) [inline]
```

### 10.180.4.7 Verify()

```
bool gdcM::Macro::Verify (
    const DataSet & ds,
    Usage const & usage ) const
```

## 10.180.5 Friends And Related Function Documentation

### 10.180.5.1 operator<<

```
std::ostream& operator<< (
    std::ostream & _os,
    const Macro & _val ) [friend]
```

The documentation for this class was generated from the following file:

- [gdcMMacro.h](#)

## 10.181 gdcM::Macros Class Reference

Class for representing a [Modules](#).

```
#include <gdcMMacros.h>
```

### Public Types

- typedef std::map< std::string, [Macro](#) > [ModuleMapType](#)

### Public Member Functions

- [Macros](#) ()=default
- void [AddMacro](#) (const char \*ref, const [Macro](#) &module)
- void [Clear](#) ()
- const [Macro](#) & [GetMacro](#) (const char \*name) const
- bool [IsEmpty](#) () const

### Friends

- std::ostream & [operator<<](#) (std::ostream &\_os, const [Macros](#) &\_val)

## 10.181.1 Detailed Description

Class for representing a [Modules](#).

### Note

bla

### See also

[Module](#)

## 10.181.2 Member Typedef Documentation

### 10.181.2.1 ModuleMapType

```
typedef std::map<std::string, Macro> gdcmmacros::ModuleMapType
```

## 10.181.3 Constructor & Destructor Documentation

### 10.181.3.1 Macros()

```
gdcmmacros::Macros ( ) [default]
```

## 10.181.4 Member Function Documentation

### 10.181.4.1 AddMacro()

```
void gdcmmacros::AddMacro (
    const char * ref,
    const Macro & module ) [inline]
```

#### 10.181.4.2 Clear()

```
void gdcM::Macros::Clear ( ) [inline]
```

#### 10.181.4.3 GetMacro()

```
const Macro& gdcM::Macros::GetMacro (
    const char * name ) const [inline]
```

#### 10.181.4.4 IsEmpty()

```
bool gdcM::Macros::IsEmpty ( ) const [inline]
```

### 10.181.5 Friends And Related Function Documentation

#### 10.181.5.1 operator<<

```
std::ostream& operator<< (
    std::ostream & _os,
    const Macros & _val ) [friend]
```

The documentation for this class was generated from the following file:

- [gdcMMacros.h](#)

## 10.182 gdcM::network::MaximumLengthSub Class Reference

[MaximumLengthSub](#).

```
#include <gdcMMaximumLengthSub.h>
```

## Public Member Functions

- [MaximumLengthSub](#) ()
- uint32\_t [GetMaximumLength](#) () const
- void [Print](#) (std::ostream &os) const
- std::istream & [Read](#) (std::istream &is)
- void [SetMaximumLength](#) (uint32\_t maximumlength)
- size\_t [Size](#) () const
- const std::ostream & [Write](#) (std::ostream &os) const

### 10.182.1 Detailed Description

[MaximumLengthSub](#).

Annex D [Table D.1-1](#) MAXIMUM LENGTH SUB-ITEM FIELDS (A-ASSOCIATE-RQ)

or

[Table D.1-2](#) Maximum length sub-item fields (A-ASSOCIATE-AC)

### 10.182.2 Constructor & Destructor Documentation

#### 10.182.2.1 MaximumLengthSub()

```
gdcn::network::MaximumLengthSub::MaximumLengthSub ( )
```

### 10.182.3 Member Function Documentation

#### 10.182.3.1 GetMaximumLength()

```
uint32_t gdcn::network::MaximumLengthSub::GetMaximumLength ( ) const [inline]
```

#### 10.182.3.2 Print()

```
void gdcn::network::MaximumLengthSub::Print (
    std::ostream & os ) const
```

### 10.182.3.3 Read()

```
std::istream& gdcM::network::MaximumLengthSub::Read (
    std::istream & is )
```

### 10.182.3.4 SetMaximumLength()

```
void gdcM::network::MaximumLengthSub::SetMaximumLength (
    uint32_t maximumlength )
```

### 10.182.3.5 Size()

```
size_t gdcM::network::MaximumLengthSub::Size ( ) const
```

### 10.182.3.6 Write()

```
const std::ostream& gdcM::network::MaximumLengthSub::Write (
    std::ostream & os ) const
```

The documentation for this class was generated from the following file:

- [gdcMMaximumLengthSub.h](#)

## 10.183 gdcM::MD5 Class Reference

Class for [MD5](#).

```
#include <gdcMD5.h>
```

### Static Public Member Functions

- static bool [Compute](#) (const char \*buffer, size\_t buf\_len, char digest\_str[33])
- static bool [ComputeFile](#) (const char \*filename, char digest\_str[33])  
*Compute md5 from a file filename*

### 10.183.1 Detailed Description

Class for [MD5](#).

#### Warning

this class is able to pick from two implementations:

1. a lightweight md5 implementation (when GDCM\_BUILD\_TESTING is turned ON)
2. the one from OpenSSL (when GDCM\_USE\_SYSTEM\_OPENSSL is turned ON)

In all other cases it will return an error

### 10.183.2 Member Function Documentation

#### 10.183.2.1 Compute()

```
static bool gdcM::MD5::Compute (  
    const char * buffer,  
    size_t buf_len,  
    char digest_str[33] ) [static]
```

#### 10.183.2.2 ComputeFile()

```
static bool gdcM::MD5::ComputeFile (  
    const char * filename,  
    char digest_str[33] ) [static]
```

Compute md5 from a file *filename*

The documentation for this class was generated from the following file:

- [gdcMMD5.h](#)

## 10.184 gdcM::MediaStorage Class Reference

[MediaStorage](#).

```
#include <gdcMMediaStorage.h>
```

## Public Types

- enum MStype {
  - MediaStorageDirectoryStorage = 0 ,
  - ComputedRadiographyImageStorage ,
  - DigitalXRayImageStorageForPresentation ,
  - DigitalXRayImageStorageForProcessing ,
  - DigitalMammographyImageStorageForPresentation ,
  - DigitalMammographyImageStorageForProcessing ,
  - DigitalIntraoralXrayImageStorageForPresentation ,
  - DigitalIntraoralXRayImageStorageForProcessing ,
  - CTImageStorage ,
  - EnhancedCTImageStorage ,
  - UltrasoundImageStorageRetired ,
  - UltrasoundImageStorage ,
  - UltrasoundMultiFrameImageStorageRetired ,
  - UltrasoundMultiFrameImageStorage ,
  - MRIImageStorage ,
  - EnhancedMRIImageStorage ,
  - MRSpectroscopyStorage ,
  - NuclearMedicineImageStorageRetired ,
  - SecondaryCaptureImageStorage ,
  - MultiframeSingleBitSecondaryCaptureImageStorage ,
  - MultiframeGrayscaleByteSecondaryCaptureImageStorage ,
  - MultiframeGrayscaleWordSecondaryCaptureImageStorage ,
  - MultiframeTrueColorSecondaryCaptureImageStorage ,
  - StandaloneOverlayStorage ,
  - StandaloneCurveStorage ,
  - LeadECGWaveformStorage ,
  - GeneralECGWaveformStorage ,
  - AmbulatoryECGWaveformStorage ,
  - HemodynamicWaveformStorage ,
  - CardiacElectrophysiologyWaveformStorage ,
  - BasicVoiceAudioWaveformStorage ,
  - StandaloneModalityLUTStorage ,
  - StandaloneVOILUTStorage ,
  - GrayscaleSoftcopyPresentationStateStorageSOPClass ,
  - XRayAngiographicImageStorage ,
  - XRayRadiofluoroscopicImageStorage ,
  - XRayAngiographicBiPlaneImageStorageRetired ,
  - NuclearMedicineImageStorage ,
  - RawDataStorage ,
  - SpacialRegistrationStorage ,
  - SpacialFiducialsStorage ,
  - PETImageStorage ,
  - RTImageStorage ,
  - RTDoseStorage ,
  - RTStructureSetStorage ,
  - RTPlanStorage ,
  - CSANonImageStorage ,
  - Philips3D ,
  - EnhancedSR ,
  - BasicTextSR ,
  - HardcopyGrayscaleImageStorage ,



```
ComprehensiveSR ,
DetachedStudyManagementSOPClass ,
EncapsulatedPDFStorage ,
EncapsulatedCDASStorage ,
StudyComponentManagementSOPClass ,
DetachedVisitManagementSOPClass ,
DetachedPatientManagementSOPClass ,
VideoEndoscopicImageStorage ,
GeneralElectricMagneticResonanceImageStorage ,
GEPrivate3DModelStorage ,
ToshibaPrivateDataStorage ,
MammographyCADSR ,
KeyObjectSelectionDocument ,
HangingProtocolStorage ,
ModalityPerformedProcedureStepSOPClass ,
PhilipsPrivateMRSyntheticImageStorage ,
VLPhotographicImageStorage ,
SegmentationStorage ,
RTIonPlanStorage ,
XRay3DAngiographicImageStorage ,
EnhancedXAImageStorage ,
RTIonBeamsTreatmentRecordStorage ,
SurfaceSegmentationStorage ,
VLWholeSlideMicroscopyImageStorage ,
RTTreatmentSummaryRecordStorage ,
EnhancedUSVolumeStorage ,
XRayRadiationDoseSR ,
VLEndoscopicImageStorage ,
BreastTomosynthesisImageStorage ,
FujiPrivateCRIImageStorage ,
OphthalmicPhotography8BitImageStorage ,
OphthalmicTomographyImageStorage ,
VLMicroscopicImageStorage ,
EnhancedPETImageStorage ,
VideoPhotographicImageStorage ,
XRay3DCraniofacialImageStorage ,
IVOCTForPresentation ,
IVOCTForProcessing ,
LegacyConvertedEnhancedCTImageStorage ,
LegacyConvertedEnhancedMRIImageStorage ,
LegacyConvertedEnhancedPETImageStorage ,
BreastProjectionXRayImageStorageForPresentation ,
BreastProjectionXRayImageStorageForProcessing ,
HardcopyColorImageStorage ,
EnhancedMRColorImageStorage ,
FujiPrivateMammoCRIImageStorage ,
OphthalmicPhotography16BitImageStorage ,
VideoMicroscopicImageStorage ,
MS_END }
• enum ObjectType {
  NoObject = 0 ,
  Video ,
  Waveform ,
  Audio ,
```

```
PDF ,  
URI ,  
Segmentation ,  
ObjectEnd }
```

## Public Member Functions

- [MediaStorage](#) (MSType type=MS\_END)
- const char \* [GetModality](#) () const
- unsigned int [GetModalityDimension](#) () const
- const char \* [GetString](#) () const  
*Return the Media [String](#) of the object.*
- void [GuessFromModality](#) (const char \*modality, unsigned int dimension=2)
- bool [IsUndefined](#) () const
- operator MSType () const
- bool [SetFromDataSet](#) (DataSet const &ds)
- bool [SetFromFile](#) (File const &file)
- bool [SetFromHeader](#) (FileMetaInformation const &fmi)
- bool [SetFromModality](#) (DataSet const &ds)

## Static Public Member Functions

- static const char \* [GetMSString](#) (MSType ts)  
*Return the Media [String](#) associated. Will return NULL for MS\_END.*
- static MSType [GetMSType](#) (const char \*str)
- static unsigned int [GetNumberOfModality](#) ()
- static unsigned int [GetNumberOfMSString](#) ()
- static unsigned int [GetNumberOfMSType](#) ()
- static bool [IsImage](#) (MSType ts)

## Protected Member Functions

- void [SetFromSourceImageSequence](#) (DataSet const &ds)

## Friends

- std::ostream & [operator<<](#) (std::ostream &os, const [MediaStorage](#) &ms)

## 10.184.1 Detailed Description

[MediaStorage](#).

### Note

FIXME There should not be any notion of [Image](#) and/or PDF at that point Only the codec can answer yes I support this Media Storage or not... For instance an [ImageCodec](#) will answer yes to most of them while a [PDFCodec](#) will answer only for the Encapsulated PDF

### See also

[UIDs](#)

### Examples

[CreateJPIPDataSet.cxx](#), [EncapsulateFileInRawData.cxx](#), [Extracting\\_All\\_Resolution.cxx](#), [Fake\\_Image\\_Using\\_Stream\\_Image\\_Writer](#), [GenAllVR.cxx](#), [GenFakeIdentifyFile.cxx](#), [GenerateStandardSOPClasses.cxx](#), [GetSubSequenceData.cxx](#), [ReadAndDumpDICOMDIR.cxx](#), [ReadAndDumpDICOMDIR2.cxx](#), [StreamImageReaderTest.cxx](#), [TemplateEmptyImage.cxx](#), [TestReader.cxx](#), [gdcmmrtionplan.cxx](#), [gdcmmrtplan.cxx](#), and [iU22tomultisc.cxx](#).

## 10.184.2 Member Enumeration Documentation

### 10.184.2.1 MStype

```
enum gdcmm::MediaStorage::MStype
```

#### Enumerator

MediaStorageDirectoryStorage	
ComputedRadiographyImageStorage	
DigitalXRayImageStorageForPresentation	
DigitalXRayImageStorageForProcessing	
DigitalMammographyImageStorageForPresentation	
DigitalMammographyImageStorageForProcessing	
DigitalIntraoralXrayImageStorageForPresentation	
DigitalIntraoralXRayImageStorageForProcessing	
CTImageStorage	
EnhancedCTImageStorage	
UltrasoundImageStorageRetired	
UltrasoundImageStorage	
UltrasoundMultiFrameImageStorageRetired	
UltrasoundMultiFrameImageStorage	
MRImageStorage	

## Enumerator

EnhancedMRIImageStorage	
MRSpectroscopyStorage	
NuclearMedicineImageStorageRetired	
SecondaryCaptureImageStorage	
MultiframeSingleBitSecondaryCaptureImageStorage	
MultiframeGrayscaleByteSecondaryCaptureImageStorage	
MultiframeGrayscaleWordSecondaryCaptureImageStorage	
MultiframeTrueColorSecondaryCaptureImageStorage	
StandaloneOverlayStorage	
StandaloneCurveStorage	
LeadECGWaveformStorage	
GeneralECGWaveformStorage	
AmbulatoryECGWaveformStorage	
HemodynamicWaveformStorage	
CardiacElectrophysiologyWaveformStorage	
BasicVoiceAudioWaveformStorage	
StandaloneModalityLUTStorage	
StandaloneVOILUTStorage	
GrayscaleSoftcopyPresentationStateStorageSOPClass	
XRyAngiographicImageStorage	
XRyRadiofluoroscopicImageStorage	
XRyAngiographicBiPlaneImageStorageRetired	
NuclearMedicineImageStorage	
RawDataStorage	
SpacialRegistrationStorage	
SpacialFiducialsStorage	
PETImageStorage	
RTImageStorage	
RTDoseStorage	
RTStructureSetStorage	
RTPlanStorage	
CSANonImageStorage	
Philips3D	
EnhancedSR	
BasicTextSR	
HardcopyGrayscaleImageStorage	
ComprehensiveSR	
DetachedStudyManagementSOPClass	
EncapsulatedPDFStorage	
EncapsulatedCDASStorage	
StudyComponentManagementSOPClass	
DetachedVisitManagementSOPClass	
DetachedPatientManagementSOPClass	

## Enumerator

VideoEndoscopicImageStorage	
GeneralElectricMagneticResonanceImageStorage	
GEPrivate3DModelStorage	
ToshibaPrivateDataStorage	
MammographyCADSR	
KeyObjectSelectionDocument	
HangingProtocolStorage	
ModalityPerformedProcedureStepSOPClass	
PhilipsPrivateMRSyntheticImageStorage	
VLPhotographicImageStorage	
SegmentationStorage	
RTIonPlanStorage	
XRay3DAngiographicImageStorage	
EnhancedXAImageStorage	
RTIonBeamsTreatmentRecordStorage	
SurfaceSegmentationStorage	
VLWholeSlideMicroscopyImageStorage	
RTTreatmentSummaryRecordStorage	
EnhancedUSVolumeStorage	
XRayRadiationDoseSR	
VLEndoscopicImageStorage	
BreastTomosynthesisImageStorage	
FujiPrivateCRImageStorage	
OphthalmicPhotography8BitImageStorage	
OphthalmicTomographyImageStorage	
VLMicroscopicImageStorage	
EnhancedPETImageStorage	
VideoPhotographicImageStorage	
XRay3DCraniofacialImageStorage	
IVOCTForPresentation	
IVOCTForProcessing	
LegacyConvertedEnhancedCTImageStorage	
LegacyConvertedEnhancedMRIImageStorage	
LegacyConvertedEnhancedPETImageStorage	
BreastProjectionXRayImageStorageForPresentation	
BreastProjectionXRayImageStorageForProcessing	
HardcopyColorImageStorage	
EnhancedMRColorImageStorage	
FujiPrivateMammoCRImageStorage	
OphthalmicPhotography16BitImageStorage	
VideoMicroscopicImageStorage	
MS_END	

## Examples

[GenerateStandardSOPClasses.cxx](#).

### 10.184.2.2 ObjectType

```
enum gdcM::MediaStorage::ObjectType
```

#### Enumerator

NoObject	
Video	
Waveform	
Audio	
PDF	
URI	
Segmentation	
ObjectEnd	

## 10.184.3 Constructor & Destructor Documentation

### 10.184.3.1 MediaStorage()

```
gdcM::MediaStorage::MediaStorage (  
    MStype type = MS_END ) [inline]
```

## 10.184.4 Member Function Documentation

### 10.184.4.1 GetModality()

```
const char* gdcM::MediaStorage::GetModality ( ) const
```

#### 10.184.4.2 GetModalityDimension()

```
unsigned int gdcM::MediaStorage::GetModalityDimension ( ) const
```

#### 10.184.4.3 GetMSString()

```
static const char* gdcM::MediaStorage::GetMSString (
    MStype ts ) [static]
```

Return the Media [String](#) associated. Will return NULL for MS\_END.

#### Examples

[GenerateStandardSOPClasses.cxx](#).

#### 10.184.4.4 GetMStype()

```
static MStype gdcM::MediaStorage::GetMStype (
    const char * str ) [static]
```

#### Examples

[MetaImageMD5Activiz.cs](#), and [TestReader.cxx](#).

#### 10.184.4.5 GetNumberOfModality()

```
static unsigned int gdcM::MediaStorage::GetNumberOfModality ( ) [static]
```

#### 10.184.4.6 GetNumberOfMSString()

```
static unsigned int gdcM::MediaStorage::GetNumberOfMSString ( ) [static]
```

#### 10.184.4.7 GetNumberOfMSType()

```
static unsigned int gdcm::MediaStorage::GetNumberOfMSType ( ) [static]
```

#### 10.184.4.8 GetString()

```
const char* gdcm::MediaStorage::GetString ( ) const
```

Return the Media [String](#) of the object.

#### Examples

[CreateJPIPDataSet.cxx](#), [EncapsulateFileInRawData.cxx](#), [Fake\\_Image\\_Using\\_Stream\\_Image\\_Writer.cxx](#),  
[GetSubSequenceData.cxx](#), [StreamImageReaderTest.cxx](#), [TemplateEmptyImage.cxx](#), and [iU22tomultisc.cxx](#).

#### 10.184.4.9 GuessFromModality()

```
void gdcm::MediaStorage::GuessFromModality (
    const char * modality,
    unsigned int dimension = 2 )
```

#### 10.184.4.10 IsImage()

```
static bool gdcm::MediaStorage::IsImage (
    MSType ts ) [static]
```

Returns whether DICOM has a Pixel Data element (7fe0,0010)

#### Warning

MRSpectroscopyStorage could be image but are not

#### Examples

[MetalImageMD5Activiz.cs](#).



#### 10.184.4.11 IsUndefined()

```
bool gdcM::MediaStorage::IsUndefined ( ) const [inline]
```

##### Examples

[TestReader.cxx](#).

#### 10.184.4.12 operator MStype()

```
gdcM::MediaStorage::operator MStype ( ) const [inline]
```

#### 10.184.4.13 SetFromDataSet()

```
bool gdcM::MediaStorage::SetFromDataSet (
    DataSet const & ds )
```

Advanced user only (functions should be protected level...) Those function are lower level than SetFromFile

#### 10.184.4.14 SetFromFile()

```
bool gdcM::MediaStorage::SetFromFile (
    File const & file )
```

Attempt to set the [MediaStorage](#) from a file: WARNING: When no [MediaStorage](#) & Modality are found BUT a PixelData element is found then [MediaStorage](#) is set to the default SecondaryCaptureImageStorage (return value is false in this case)

##### Examples

[ReadAndDumpDICOMDIR.cxx](#), [ReadAndDumpDICOMDIR2.cxx](#), [TestReader.cxx](#), [gdcMrtionplan.cxx](#), and [gdcMrtplan.cxx](#).

#### 10.184.4.15 SetFromHeader()

```
bool gdcM::MediaStorage::SetFromHeader (
    FileMetaInformation const & fmi )
```

#### 10.184.4.16 SetFromModality()

```
bool gdcM::MediaStorage::SetFromModality (
    DataSet const & ds )
```

#### 10.184.4.17 SetFromSourceImageSequence()

```
void gdcM::MediaStorage::SetFromSourceImageSequence (
    DataSet const & ds ) [protected]
```

### 10.184.5 Friends And Related Function Documentation

#### 10.184.5.1 operator<<

```
std::ostream& operator<< (
    std::ostream & os,
    const MediaStorage & ms ) [friend]
```

The documentation for this class was generated from the following file:

- [gdcMMediaStorage.h](#)

### 10.185 gdcM::MemberCommand< T > Class Template Reference

[Command](#) subclass that calls a pointer to a member function.

```
#include <gdcMCommand.h>
```

Inheritance diagram for gdcM::MemberCommand< T >:

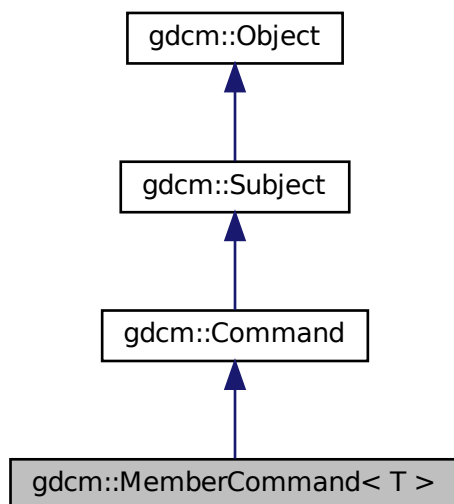

Collaboration diagram for gdcM::MemberCommand< T >:

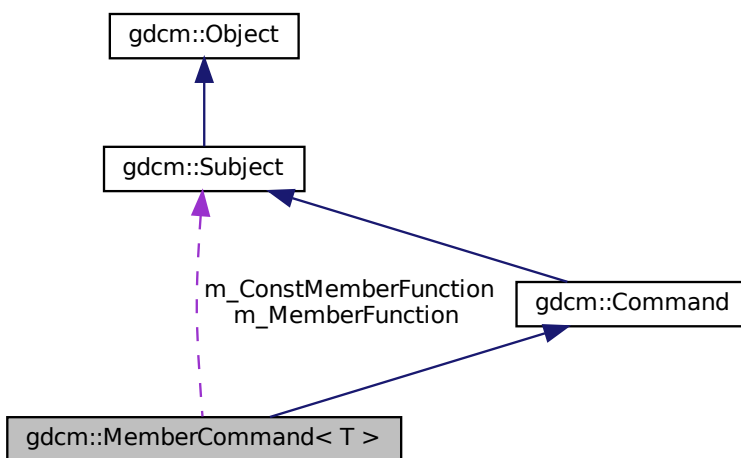

## Public Types

- typedef [MemberCommand](#) Self

- typedef void(T::\* [TConstMemberFunctionPointer](#)) (const [Subject](#) \*, const [Event](#) &)
- typedef void(T::\* [TMemberFunctionPointer](#)) ([Subject](#) \*, const [Event](#) &)

## Public Member Functions

- [MemberCommand](#) (const [Self](#) &)=delete
- void [Execute](#) (const [Subject](#) \*caller, const [Event](#) &event) override
- void [Execute](#) ([Subject](#) \*caller, const [Event](#) &event) override
- void [operator=](#) (const [Self](#) &)=delete
- void [SetCallbackFunction](#) (T \*object, [TConstMemberFunctionPointer](#) memberFunction)
- void [SetCallbackFunction](#) (T \*object, [TMemberFunctionPointer](#) memberFunction)

## Static Public Member Functions

- static [SmartPointer](#)< [MemberCommand](#) > [New](#) ()

## Protected Member Functions

- [MemberCommand](#) ()
- [~MemberCommand](#) () override=default

## Protected Attributes

- [TConstMemberFunctionPointer](#) [m\\_ConstMemberFunction](#)
- [TMemberFunctionPointer](#) [m\\_MemberFunction](#)
- T \* [m\\_This](#)

### 10.185.1 Detailed Description

```
template<class T>
class gdcn::MemberCommand< T >
```

[Command](#) subclass that calls a pointer to a member function.

[MemberCommand](#) calls a pointer to a member function with the same arguments as [Execute](#) on [Command](#).

### 10.185.2 Member Typedef Documentation

### 10.185.2.1 Self

```
template<class T >
typedef MemberCommand gdcM::MemberCommand< T >::Self
```

Standard class typedefs.

### 10.185.2.2 TConstMemberFunctionPointer

```
template<class T >
typedef void(T::* gdcM::MemberCommand< T >::TConstMemberFunctionPointer) (const Subject *, const Event &)
```

### 10.185.2.3 TMemberFunctionPointer

```
template<class T >
typedef void(T::* gdcM::MemberCommand< T >::TMemberFunctionPointer) (Subject *, const Event &)
```

pointer to a member function that takes a Subject\* and the event

## 10.185.3 Constructor & Destructor Documentation

### 10.185.3.1 MemberCommand() [1/2]

```
template<class T >
gdcM::MemberCommand< T >::MemberCommand (
    const Self & ) [delete]
```

### 10.185.3.2 MemberCommand() [2/2]

```
template<class T >
gdcM::MemberCommand< T >::MemberCommand ( ) [inline], [protected]
```

Referenced by gdcM::MemberCommand< T >::New().

### 10.185.3.3 ~MemberCommand()

```
template<class T >
gdcM::MemberCommand< T >::~~MemberCommand ( ) [override], [protected], [default]
```

## 10.185.4 Member Function Documentation

### 10.185.4.1 Execute() [1/2]

```
template<class T >
void gdcM::MemberCommand< T >::Execute (
    const Subject * caller,
    const Event & event ) [inline], [override], [virtual]
```

Invoke the member function with a const object.

Implements [gdcM::Command](#).

References [gdcM::MemberCommand< T >::m\\_ConstMemberFunction](#).

### 10.185.4.2 Execute() [2/2]

```
template<class T >
void gdcM::MemberCommand< T >::Execute (
    Subject * caller,
    const Event & event ) [inline], [override], [virtual]
```

Invoke the member function.

Implements [gdcM::Command](#).

References [gdcM::MemberCommand< T >::m\\_MemberFunction](#).

### 10.185.4.3 New()

```
template<class T >
static SmartPointer<MemberCommand> gdcM::MemberCommand< T >::New ( ) [inline], [static]
```

Method for creation through the object factory.

References [gdcM::MemberCommand< T >::MemberCommand\(\)](#).

#### 10.185.4.4 operator=()

```
template<class T >
void gdcM::MemberCommand< T >::operator= (
    const Self & ) [delete]
```

#### 10.185.4.5 SetCallbackFunction() [1/2]

```
template<class T >
void gdcM::MemberCommand< T >::SetCallbackFunction (
    T * object,
    TConstMemberFunctionPointer memberFunction ) [inline]
```

References gdcM::MemberCommand< T >::m\_ConstMemberFunction, and gdcM::MemberCommand< T >::m\_This.

#### 10.185.4.6 SetCallbackFunction() [2/2]

```
template<class T >
void gdcM::MemberCommand< T >::SetCallbackFunction (
    T * object,
    TMemberFunctionPointer memberFunction ) [inline]
```

Run-time type information (and related methods). Set the callback function along with the object that it will be invoked on.

References gdcM::MemberCommand< T >::m\_MemberFunction, and gdcM::MemberCommand< T >::m\_This.

### 10.185.5 Member Data Documentation

#### 10.185.5.1 m\_ConstMemberFunction

```
template<class T >
TConstMemberFunctionPointer gdcM::MemberCommand< T >::m_ConstMemberFunction [protected]
```

Referenced by gdcM::MemberCommand< T >::Execute(), and gdcM::MemberCommand< T >::SetCallbackFunction().

### 10.185.5.2 m\_MemberFunction

```
template<class T >
TMemberFunctionPointer gdcM::MemberCommand< T >::m_MemberFunction [protected]
```

Referenced by `gdcM::MemberCommand< T >::Execute()`, and `gdcM::MemberCommand< T >::SetCallbackFunction()`.

### 10.185.5.3 m\_This

```
template<class T >
T* gdcM::MemberCommand< T >::m_This [protected]
```

Referenced by `gdcM::MemberCommand< T >::SetCallbackFunction()`.

The documentation for this class was generated from the following file:

- [gdcMCommand.h](#)

## 10.186 gdcM::MeshPrimitive Class Reference

This class defines surface mesh primitives.

```
#include <gdcMMeshPrimitive.h>
```

Inheritance diagram for `gdcM::MeshPrimitive`:

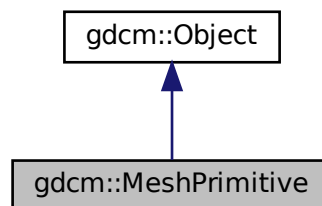



Collaboration diagram for gdcM::MeshPrimitive:

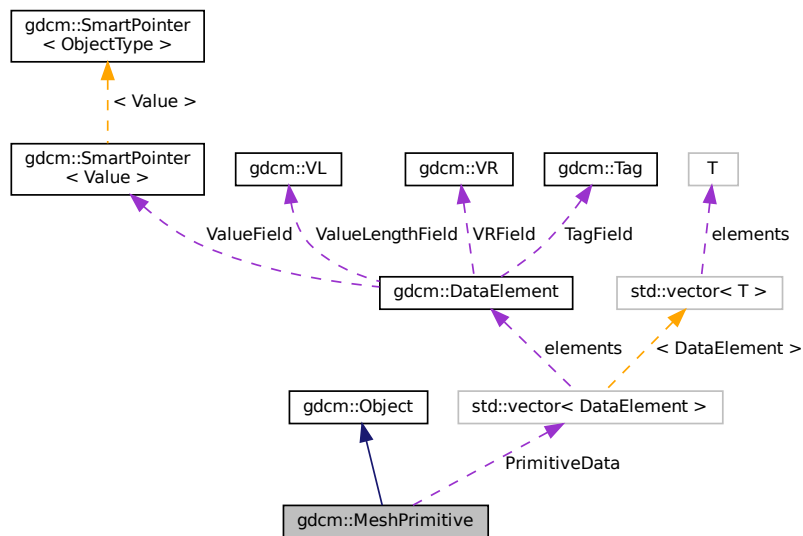

## Public Types

- enum `MPType` {  
`VERTEX = 0` ,  
`EDGE` ,  
`TRIANGLE` ,  
`TRIANGLE_STRIP` ,  
`TRIANGLE_FAN` ,  
`LINE` ,  
`FACET` ,  
`MPType_END` }

*This enumeration defines primitive types.*

- typedef `std::vector< DataElement >` `PrimitivesData`

## Public Member Functions

- `MeshPrimitive ()`
- `~MeshPrimitive ()` override
- void `AddPrimitiveData (DataElement const &de)`
- unsigned int `GetNumberOfPrimitivesData ()` const
- `DataElement & GetPrimitiveData ()`
- const `DataElement & GetPrimitiveData ()` const
- `DataElement & GetPrimitiveData (const unsigned int idx)`
- const `DataElement & GetPrimitiveData (const unsigned int idx)` const
- `PrimitivesData & GetPrimitivesData ()`
- const `PrimitivesData & GetPrimitivesData ()` const

- [MPTYPE GetPrimitiveType](#) () const
- void [SetPrimitiveData](#) (const unsigned int idx, [DataElement](#) const &de)
- void [SetPrimitiveData](#) ([DataElement](#) const &de)
- void [SetPrimitivesData](#) ([PrimitivesData](#) const &DEs)
- void [SetPrimitiveType](#) (const [MPTYPE](#) type)

### Static Public Member Functions

- static [MPTYPE GetMPTYPE](#) (const char \*type)
- static const char \* [GetMPTYPEString](#) (const [MPTYPE](#) type)

### Protected Attributes

- [PrimitivesData](#) [PrimitiveData](#)
- [MPTYPE](#) [PrimitiveType](#)

### Additional Inherited Members

#### 10.186.1 Detailed Description

This class defines surface mesh primitives.

It is designed from surface mesh primitives macro.

See also

PS 3.3 C.27.4

#### 10.186.2 Member Typedef Documentation

##### 10.186.2.1 PrimitivesData

```
typedef std::vector< DataElement > gdcm::MeshPrimitive::PrimitivesData
```

#### 10.186.3 Member Enumeration Documentation

##### 10.186.3.1 MPTYPE

```
enum gdcm::MeshPrimitive::MPTYPE
```

This enumeration defines primitive types.

See also

PS 3.3 C.27.4.1

## Enumerator

VERTEX	
EDGE	
TRIANGLE	
TRIANGLE_STRIP	
TRIANGLE_FAN	
LINE	
FACET	
MPType_END	

## 10.186.4 Constructor & Destructor Documentation

### 10.186.4.1 MeshPrimitive()

```
gdcM::MeshPrimitive::MeshPrimitive ( )
```

### 10.186.4.2 ~MeshPrimitive()

```
gdcM::MeshPrimitive::~~MeshPrimitive ( ) [override]
```

## 10.186.5 Member Function Documentation

### 10.186.5.1 AddPrimitiveData()

```
void gdcM::MeshPrimitive::AddPrimitiveData (
    DataElement const & de )
```

### 10.186.5.2 GetMPType()

```
static MPType gdcM::MeshPrimitive::GetMPType (
    const char * type ) [static]
```

### 10.186.5.3 GetMPTypeString()

```
static const char* gdcM::MeshPrimitive::GetMPTypeString (
    const MPType type ) [static]
```

### 10.186.5.4 GetNumberOfPrimitivesData()

```
unsigned int gdcM::MeshPrimitive::GetNumberOfPrimitivesData ( ) const
```

### 10.186.5.5 GetPrimitiveData() [1/4]

```
DataElement& gdcM::MeshPrimitive::GetPrimitiveData ( )
```

### 10.186.5.6 GetPrimitiveData() [2/4]

```
const DataElement& gdcM::MeshPrimitive::GetPrimitiveData ( ) const
```

### 10.186.5.7 GetPrimitiveData() [3/4]

```
DataElement& gdcM::MeshPrimitive::GetPrimitiveData (
    const unsigned int idx )
```

### 10.186.5.8 GetPrimitiveData() [4/4]

```
const DataElement& gdcM::MeshPrimitive::GetPrimitiveData (
    const unsigned int idx ) const
```

### 10.186.5.9 GetPrimitivesData() [1/2]

```
PrimitivesData& gdcM::MeshPrimitive::GetPrimitivesData ( )
```

### 10.186.5.10 GetPrimitivesData() [2/2]

```
const PrimitivesData& gdcM::MeshPrimitive::GetPrimitivesData ( ) const
```

### 10.186.5.11 GetPrimitiveType()

```
MPTypе gdcM::MeshPrimitive::GetPrimitiveType ( ) const
```

### 10.186.5.12 SetPrimitiveData() [1/2]

```
void gdcM::MeshPrimitive::SetPrimitiveData (
    const unsigned int idx,
    DataElement const & de )
```

### 10.186.5.13 SetPrimitiveData() [2/2]

```
void gdcM::MeshPrimitive::SetPrimitiveData (
    DataElement const & de )
```

### 10.186.5.14 SetPrimitivesData()

```
void gdcM::MeshPrimitive::SetPrimitivesData (
    PrimitivesData const & DEs )
```

### 10.186.5.15 SetPrimitiveType()

```
void gdcM::MeshPrimitive::SetPrimitiveType (
    const MPTypе type )
```

## 10.186.6 Member Data Documentation

### 10.186.6.1 PrimitiveData

`PrimitivesData` `gdcM::MeshPrimitive::PrimitiveData` [protected]

### 10.186.6.2 PrimitiveType

`MPTType` `gdcM::MeshPrimitive::PrimitiveType` [protected]

The documentation for this class was generated from the following file:

- [gdcMMeshPrimitive.h](#)

## 10.187 gdcM::ModalityPerformedProcedureStepCreateQuery Class Reference

[ModalityPerformedProcedureStepCreateQuery](#).

```
#include <gdcMModalityPerformedProcedureStepCreateQuery.h>
```

Inheritance diagram for `gdcM::ModalityPerformedProcedureStepCreateQuery`:

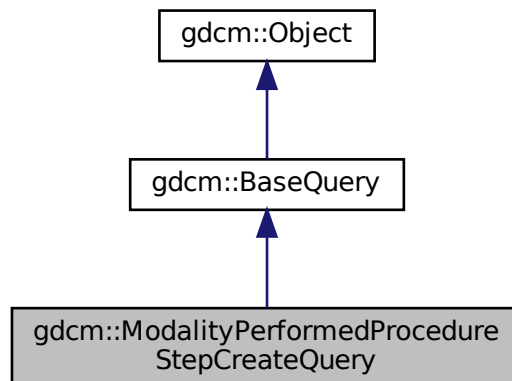

Collaboration diagram for gdcm::ModalityPerformedProcedureStepCreateQuery:

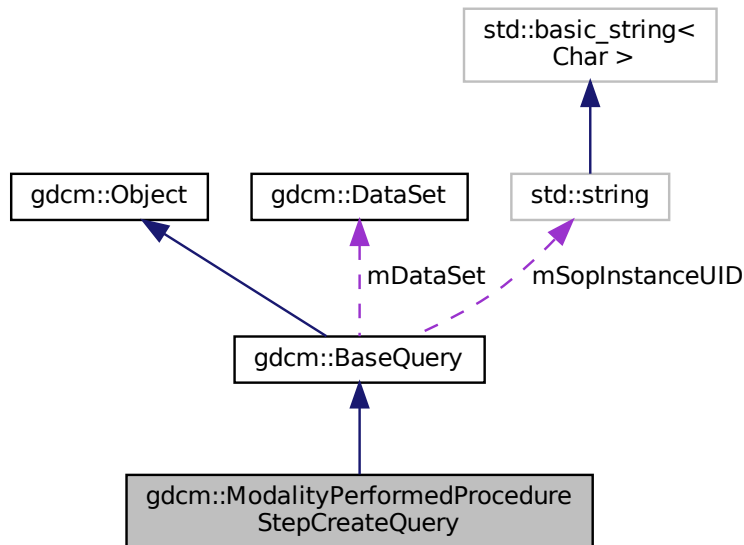

## Public Member Functions

- [ModalityPerformedProcedureStepCreateQuery](#) (const std::string &iSopInstanceUID)
- [UIDs::TSName GetAbstractSyntaxUID](#) () const override
- [gdcm::DataSet GetRequiredDataSet](#) () const
- bool [ValidateQuery](#) (bool inStrict=true) const override

## Friends

- class [QueryFactory](#)

## Additional Inherited Members

### 10.187.1 Detailed Description

[ModalityPerformedProcedureStepCreateQuery](#).

contains: the class which will produce a dataset for n-create for Modality Performed Procedure Step sop class

## 10.187.2 Constructor & Destructor Documentation

### 10.187.2.1 ModalityPerformedProcedureStepCreateQuery()

```
gdcm::ModalityPerformedProcedureStepCreateQuery::ModalityPerformedProcedureStepCreateQuery (
    const std::string & iSopInstanceUID )
```

## 10.187.3 Member Function Documentation

### 10.187.3.1 GetAbstractSyntaxUID()

```
UIDs::TSName gdcm::ModalityPerformedProcedureStepCreateQuery::GetAbstractSyntaxUID ( ) const [override],
[virtual]
```

Implements [gdcm::BaseQuery](#).

### 10.187.3.2 GetRequiredDataSet()

```
gdcm::DataSet gdcm::ModalityPerformedProcedureStepCreateQuery::GetRequiredDataSet ( ) const
```

### 10.187.3.3 ValidateQuery()

```
bool gdcm::ModalityPerformedProcedureStepCreateQuery::ValidateQuery (
    bool inStrict = true ) const [override], [virtual]
```

Implements [gdcm::BaseQuery](#).

## 10.187.4 Friends And Related Function Documentation



### 10.187.4.1 QueryFactory

```
friend class QueryFactory [friend]
```

The documentation for this class was generated from the following file:

- [gdcMModalityPerformedProcedureStepCreateQuery.h](#)

## 10.188 gdcM::ModalityPerformedProcedureStepSetQuery Class Reference

[ModalityPerformedProcedureStepSetQuery](#).

```
#include <gdcMModalityPerformedProcedureStepSetQuery.h>
```

Inheritance diagram for gdcM::ModalityPerformedProcedureStepSetQuery:

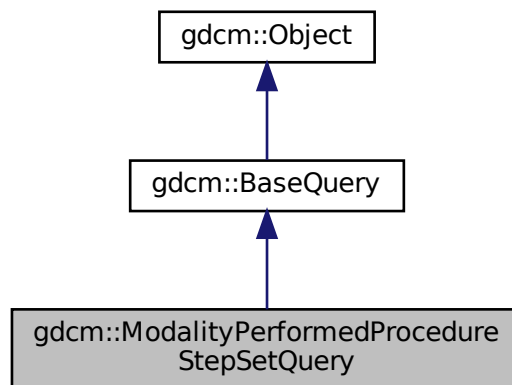

Collaboration diagram for `gdcM::ModalityPerformedProcedureStepSetQuery`:

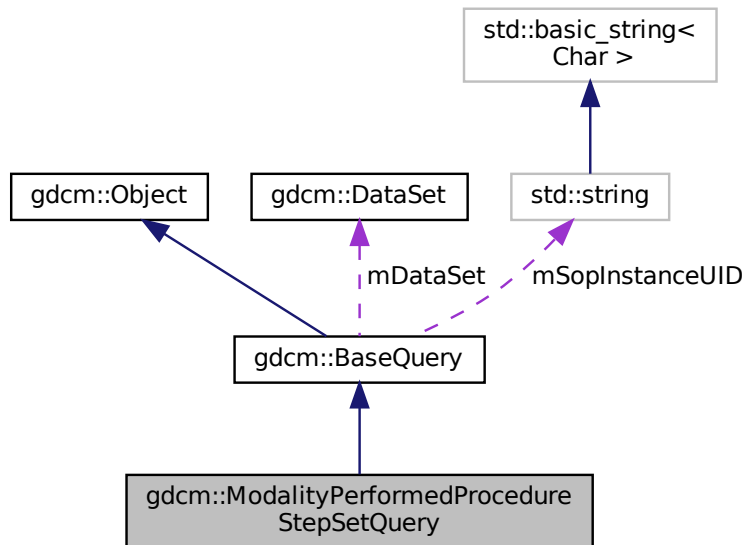

## Public Member Functions

- [ModalityPerformedProcedureStepSetQuery](#) (const std::string &iSopInstanceUID)
- [UIDs::TSName GetAbstractSyntaxUID](#) () const override
- [gdcM::DataSet GetRequiredDataSet](#) () const
- bool [ValidateQuery](#) (bool inStrict=true) const override

## Friends

- class [QueryFactory](#)

## Additional Inherited Members

### 10.188.1 Detailed Description

[ModalityPerformedProcedureStepSetQuery](#).

contains: the class which will produce a dataset for n-set for Modality Performed Procedure Step sop class

## 10.188.2 Constructor & Destructor Documentation

### 10.188.2.1 ModalityPerformedProcedureStepSetQuery()

```
gdcm::ModalityPerformedProcedureStepSetQuery::ModalityPerformedProcedureStepSetQuery (
    const std::string & iSopInstanceUID )
```

## 10.188.3 Member Function Documentation

### 10.188.3.1 GetAbstractSyntaxUID()

```
UIDs::TSName gdcm::ModalityPerformedProcedureStepSetQuery::GetAbstractSyntaxUID ( ) const [override],
[virtual]
```

Implements [gdcm::BaseQuery](#).

### 10.188.3.2 GetRequiredDataSet()

```
gdcm::DataSet gdcm::ModalityPerformedProcedureStepSetQuery::GetRequiredDataSet ( ) const
```

### 10.188.3.3 ValidateQuery()

```
bool gdcm::ModalityPerformedProcedureStepSetQuery::ValidateQuery (
    bool inStrict = true ) const [override], [virtual]
```

Implements [gdcm::BaseQuery](#).

## 10.188.4 Friends And Related Function Documentation

### 10.188.4.1 QueryFactory

```
friend class QueryFactory [friend]
```

The documentation for this class was generated from the following file:

- [gdcModalityPerformedProcedureStepSetQuery.h](#)

## 10.189 gdcM::ModifiedEvent Class Reference

```
#include <gdcEvent.h>
```

Inheritance diagram for gdcM::ModifiedEvent:

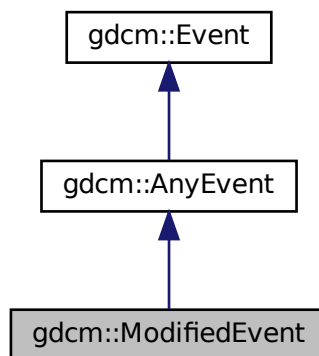

Collaboration diagram for gdcM::ModifiedEvent:

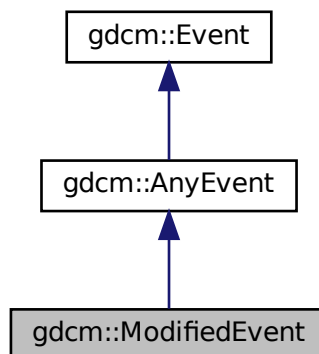

## Additional Inherited Members

The documentation for this class was generated from the following file:

- [gdcmEvent.h](#)

## 10.190 gdcm::Module Class Reference

Class for representing a [Module](#).

```
#include <gdcmModule.h>
```

### Public Types

- typedef std::vector< std::string > [ArrayIncludeMacrosType](#)
- typedef std::map< [Tag](#), [ModuleEntry](#) > [MapModuleEntry](#)

### Public Member Functions

- [Module](#) ()=default
- void [AddMacro](#) (const char \*include)
- void [AddModuleEntry](#) (const [Tag](#) &tag, const [ModuleEntry](#) &module)  
*Will add a [ModuleEntry](#) directly at root-level. See [Macro](#) for nested-included level.*
- void [Clear](#) ()
- bool [FindModuleEntryInMacros](#) ([Macros](#) const &macros, const [Tag](#) &tag) const
- const [ModuleEntry](#) & [GetModuleEntryInMacros](#) ([Macros](#) const &macros, const [Tag](#) &tag) const
- const char \* [GetName](#) () const
- void [SetName](#) (const char \*name)
- bool [Verify](#) (const [DataSet](#) &ds, [Usage](#) const &usage) const

### Friends

- std::ostream & [operator<<](#) (std::ostream &\_os, const [Module](#) &\_val)

### 10.190.1 Detailed Description

Class for representing a [Module](#).

#### Note

[Module](#): A set of Attributes within an Information Entity or Normalized [IOD](#) which are logically related to each other.

#### See also

[Macro](#)

## 10.190.2 Member Typedef Documentation

### 10.190.2.1 ArrayIncludeMacroType

```
typedef std::vector<std::string> gdcM::Module::ArrayIncludeMacroType
```

### 10.190.2.2 MapModuleEntry

```
typedef std::map<Tag, ModuleEntry> gdcM::Module::MapModuleEntry
```

## 10.190.3 Constructor & Destructor Documentation

### 10.190.3.1 Module()

```
gdcM::Module::Module ( ) [default]
```

## 10.190.4 Member Function Documentation

### 10.190.4.1 AddMacro()

```
void gdcM::Module::AddMacro (
    const char * include ) [inline]
```

### 10.190.4.2 AddModuleEntry()

```
void gdcM::Module::AddModuleEntry (
    const Tag & tag,
    const ModuleEntry & module ) [inline]
```

Will add a [ModuleEntry](#) directly at root-level. See [Macro](#) for nested-included level.

#### 10.190.4.3 Clear()

```
void gdcM::Module::Clear ( ) [inline]
```

#### 10.190.4.4 FindModuleEntryInMacros()

```
bool gdcM::Module::FindModuleEntryInMacros (
    Macros const & macros,
    const Tag & tag ) const
```

Find or Get a [ModuleEntry](#). [ModuleEntry](#) are either search are root-level or within nested-macro included in module.

#### 10.190.4.5 GetModuleEntryInMacros()

```
const ModuleEntry& gdcM::Module::GetModuleEntryInMacros (
    Macros const & macros,
    const Tag & tag ) const
```

#### 10.190.4.6 GetName()

```
const char* gdcM::Module::GetName ( ) const [inline]
```

#### 10.190.4.7 SetName()

```
void gdcM::Module::SetName (
    const char * name ) [inline]
```

#### 10.190.4.8 Verify()

```
bool gdcM::Module::Verify (
    const DataSet & ds,
    Usage const & usage ) const
```

### 10.190.5 Friends And Related Function Documentation

### 10.190.5.1 operator<<

```
std::ostream& operator<< (
    std::ostream & _os,
    const Module & _val ) [friend]
```

The documentation for this class was generated from the following file:

- [gdcModule.h](#)

## 10.191 gdcM::ModuleEntry Class Reference

Class for representing a [ModuleEntry](#).

```
#include <gdcModuleEntry.h>
```

Inheritance diagram for gdcM::ModuleEntry:

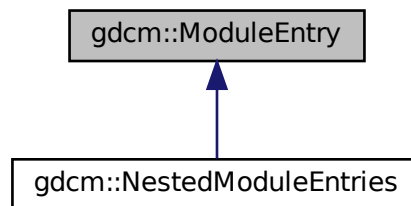



Collaboration diagram for gdcm::ModuleEntry:

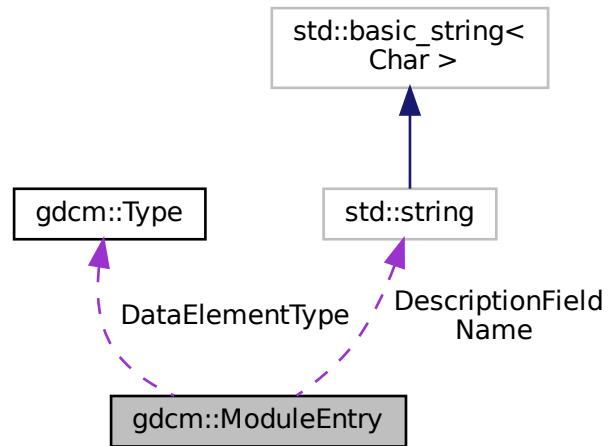

## Public Types

- typedef std::string [Description](#)

## Public Member Functions

- [ModuleEntry](#) (const char \*name="", const char \*type="3", const char \*description="")
- virtual [~ModuleEntry](#) ()=default
- const [Description](#) & [GetDescription](#) () const
- const char \* [GetName](#) () const
- const [Type](#) & [GetType](#) () const
- void [SetDescription](#) (const char \*d)
- void [SetName](#) (const char \*name)
- void [SetType](#) (const [Type](#) &type)

## Protected Attributes

- [Type](#) [DataElementType](#)
- [Description](#) [DescriptionField](#)
- std::string [Name](#)

## Friends

- std::ostream & [operator<<](#) (std::ostream &\_os, const [ModuleEntry](#) &\_val)

### 10.191.1 Detailed Description

Class for representing a [ModuleEntry](#).

#### Note

bla

#### See also

[DictEntry](#)

### 10.191.2 Member Typedef Documentation

#### 10.191.2.1 Description

```
typedef std::string gdcM::ModuleEntry::Description
```

### 10.191.3 Constructor & Destructor Documentation

#### 10.191.3.1 ModuleEntry()

```
gdcM::ModuleEntry::ModuleEntry (  
    const char * name = "",  
    const char * type = "3",  
    const char * description = "" ) [inline]
```

References [gdcM::Type::GetTypeType\(\)](#).

#### 10.191.3.2 ~ModuleEntry()

```
virtual gdcM::ModuleEntry::~~ModuleEntry ( ) [virtual], [default]
```

### 10.191.4 Member Function Documentation

#### 10.191.4.1 GetDescription()

```
const Description& gdcM::ModuleEntry::GetDescription ( ) const [inline]
```

#### 10.191.4.2 GetName()

```
const char* gdcM::ModuleEntry::GetName ( ) const [inline]
```

#### 10.191.4.3 GetType()

```
const Type& gdcM::ModuleEntry::GetType ( ) const [inline]
```

#### 10.191.4.4 SetDescription()

```
void gdcM::ModuleEntry::SetDescription (
    const char * d ) [inline]
```

#### 10.191.4.5 SetName()

```
void gdcM::ModuleEntry::SetName (
    const char * name ) [inline]
```

#### 10.191.4.6 SetType()

```
void gdcM::ModuleEntry::SetType (
    const Type & type ) [inline]
```

### 10.191.5 Friends And Related Function Documentation

### 10.191.5.1 operator<<

```
std::ostream& operator<< (
    std::ostream & _os,
    const ModuleEntry & _val ) [friend]
```

## 10.191.6 Member Data Documentation

### 10.191.6.1 DataElementType

Type gdcmmoduleentry::DataElementType [protected]

### 10.191.6.2 DescriptionField

Description gdcmmoduleentry::DescriptionField [protected]

### 10.191.6.3 Name

std::string gdcmmoduleentry::Name [protected]

The documentation for this class was generated from the following file:

- [gdcmmoduleentry.h](#)

## 10.192 gdcmmoduleentry::Modules Class Reference

Class for representing a [Modules](#).

```
#include <gdcmmoduleentry.h>
```

### Public Types

- typedef std::map< std::string, [Module](#) > [ModuleMapType](#)

## Public Member Functions

- [Modules](#) ()=default
- void [AddModule](#) (const char \*ref, const [Module](#) &module)
- void [Clear](#) ()
- const [Module](#) & [GetModule](#) (const char \*name) const
- bool [IsEmpty](#) () const

## Friends

- std::ostream & [operator<<](#) (std::ostream &\_os, const [Modules](#) &\_val)

### 10.192.1 Detailed Description

Class for representing a [Modules](#).

#### Note

bla

#### See also

[Module](#)

### 10.192.2 Member Typedef Documentation

#### 10.192.2.1 ModuleMapType

```
typedef std::map<std::string, Module> gdcmm::Modules::ModuleMapType
```

### 10.192.3 Constructor & Destructor Documentation

#### 10.192.3.1 Modules()

```
gdcmm::Modules::Modules ( ) [default]
```

## 10.192.4 Member Function Documentation

### 10.192.4.1 AddModule()

```
void gdcM::Modules::AddModule (
    const char * ref,
    const Module & module ) [inline]
```

### 10.192.4.2 Clear()

```
void gdcM::Modules::Clear ( ) [inline]
```

### 10.192.4.3 GetModule()

```
const Module& gdcM::Modules::GetModule (
    const char * name ) const [inline]
```

### 10.192.4.4 IsEmpty()

```
bool gdcM::Modules::IsEmpty ( ) const [inline]
```

## 10.192.5 Friends And Related Function Documentation

### 10.192.5.1 operator<<

```
std::ostream& operator<< (
    std::ostream & _os,
    const Modules & _val ) [friend]
```

The documentation for this class was generated from the following file:

- [gdcMModules.h](#)

## 10.193 gdcm::MovePatientRootQuery Class Reference

[MovePatientRootQuery](#).

```
#include <gdcmMovePatientRootQuery.h>
```

Inheritance diagram for gdcm::MovePatientRootQuery:

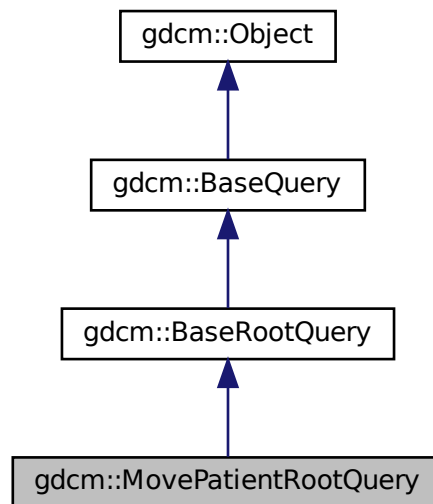

Collaboration diagram for gdcm::MovePatientRootQuery:

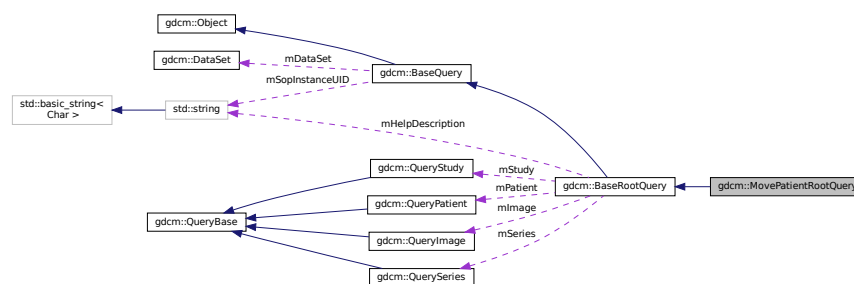

### Public Member Functions

- [MovePatientRootQuery](#) ()
- [UIDs::TSName GetAbstractSyntaxUID](#) () const override
- `std::vector< Tag >` [GetTagListByLevel](#) (const [EQueryLevel](#) &inQueryLevel) override
- void [InitializeDataSet](#) (const [EQueryLevel](#) &inQueryLevel) override
- bool [ValidateQuery](#) (bool inStrict=true) const override

## Friends

- class [QueryFactory](#)

## Additional Inherited Members

### 10.193.1 Detailed Description

[MovePatientRootQuery](#).

contains: the class which will produce a dataset for c-move with patient root

### 10.193.2 Constructor & Destructor Documentation

#### 10.193.2.1 MovePatientRootQuery()

```
gdcM::MovePatientRootQuery::MovePatientRootQuery ( )
```

### 10.193.3 Member Function Documentation

#### 10.193.3.1 GetAbstractSyntaxUID()

```
UIDs::TSName gdcM::MovePatientRootQuery::GetAbstractSyntaxUID ( ) const [override], [virtual]
```

Implements [gdcM::BaseQuery](#).

#### 10.193.3.2 GetTagListByLevel()

```
std::vector<Tag> gdcM::MovePatientRootQuery::GetTagListByLevel (
    const EQueryLevel & inQueryLevel ) [override], [virtual]
```

this function will return all tags at a given query level, so that they maybe selected for searching. The boolean forFind is true if the query is a find query, or false for a move query.

Implements [gdcM::BaseRootQuery](#).



### 10.193.3.3 InitializeDataSet()

```
void gdcm::MovePatientRootQuery::InitializeDataSet (
    const EQueryLevel & inQueryLevel ) [override], [virtual]
```

this function sets tag 8,52 to the appropriate value based on query level also fills in the right unique tags, as per the standard's requirements should allow for connection with dcmTk

Implements [gdcm::BaseRootQuery](#).

### 10.193.3.4 ValidateQuery()

```
bool gdcm::MovePatientRootQuery::ValidateQuery (
    bool inStrict = true ) const [override], [virtual]
```

have to be able to ensure that 0x8,0x52 is set (which will be true if InitializeDataSet is called...) that the level is appropriate (ie, not setting PATIENT for a study query that the tags in the query match the right level (either required, unique, optional) by default, this function checks to see if the query is for finding, which is more permissive than for moving. For moving, only the unique tags are allowed. 10 Jan 2011: adding in the 'strict' mode. according to the standard (at least, how I've read it), only tags for a particular level should be allowed in a particular query (ie, just series level tags in a series level query). However, it seems that dcm4chee doesn't share that interpretation. So, if 'inStrict' is false, then tags from the current level and all higher levels are now considered valid. So, if you're doing a non-strict series-level query, tags from the patient and study level can be passed along as well.

Implements [gdcm::BaseRootQuery](#).

## 10.193.4 Friends And Related Function Documentation

### 10.193.4.1 QueryFactory

```
friend class QueryFactory [friend]
```

The documentation for this class was generated from the following file:

- [gdcmMovePatientRootQuery.h](#)

## 10.194 gdcm::MoveStudyRootQuery Class Reference

[MoveStudyRootQuery](#).

```
#include <gdcmMoveStudyRootQuery.h>
```

Inheritance diagram for gdcm::MoveStudyRootQuery:

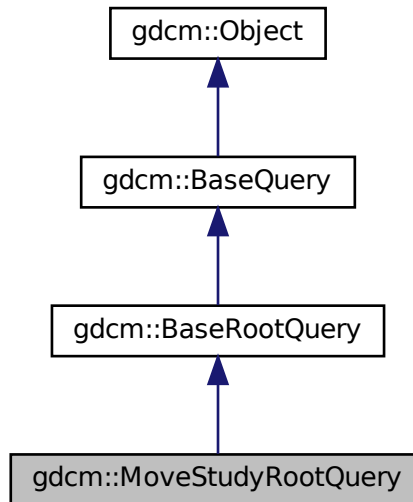

Collaboration diagram for gdcm::MoveStudyRootQuery:

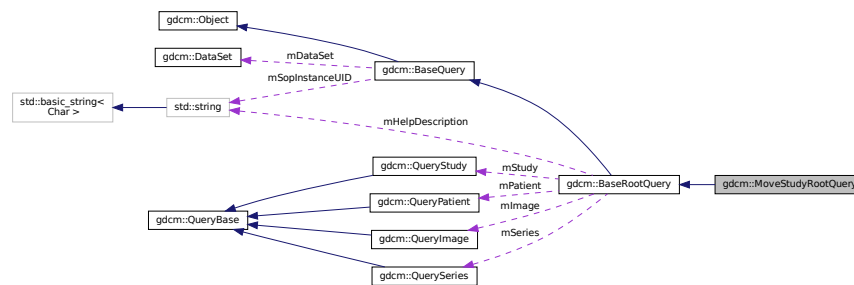

### Public Member Functions

- [MoveStudyRootQuery](#) ()
- `UIDs::TSName GetAbstractSyntaxUID` () const override
- `std::vector< Tag > GetTagListByLevel` (const `EQueryLevel` &inQueryLevel) override
- void `InitializeDataSet` (const `EQueryLevel` &inQueryLevel) override
- bool `ValidateQuery` (bool inStrict=true) const override

## Friends

- class [QueryFactory](#)

## Additional Inherited Members

### 10.194.1 Detailed Description

[MoveStudyRootQuery](#).

contains: the class which will produce a dataset for C-MOVE with study root

### 10.194.2 Constructor & Destructor Documentation

#### 10.194.2.1 MoveStudyRootQuery()

```
gdcm::MoveStudyRootQuery::MoveStudyRootQuery ( )
```

### 10.194.3 Member Function Documentation

#### 10.194.3.1 GetAbstractSyntaxUID()

```
UIDs::TSName gdcm::MoveStudyRootQuery::GetAbstractSyntaxUID ( ) const [override], [virtual]
```

Implements [gdcm::BaseQuery](#).

#### 10.194.3.2 GetTagListByLevel()

```
std::vector<Tag> gdcm::MoveStudyRootQuery::GetTagListByLevel (
    const EQueryLevel & inQueryLevel ) [override], [virtual]
```

this function will return all tags at a given query level, so that they maybe selected for searching. The boolean forFind is true if the query is a find query, or false for a move query.

Implements [gdcm::BaseRootQuery](#).

### 10.194.3.3 InitializeDataSet()

```
void gdcm::MoveStudyRootQuery::InitializeDataSet (
    const EQueryLevel & inQueryLevel ) [override], [virtual]
```

this function sets tag 8,52 to the appropriate value based on query level also fills in the right unique tags, as per the standard's requirements should allow for connection with dcmTk

Implements [gdcm::BaseRootQuery](#).

### 10.194.3.4 ValidateQuery()

```
bool gdcm::MoveStudyRootQuery::ValidateQuery (
    bool inStrict = true ) const [override], [virtual]
```

have to be able to ensure that 0x8,0x52 is set (which will be true if InitializeDataSet is called...) that the level is appropriate (ie, not setting PATIENT for a study query that the tags in the query match the right level (either required, unique, optional) by default, this function checks to see if the query is for finding, which is more permissive than for moving. For moving, only the unique tags are allowed. 10 Jan 2011: adding in the 'strict' mode. according to the standard (at least, how I've read it), only tags for a particular level should be allowed in a particular query (ie, just series level tags in a series level query). However, it seems that dcm4chee doesn't share that interpretation. So, if 'inStrict' is false, then tags from the current level and all higher levels are now considered valid. So, if you're doing a non-strict series-level query, tags from the patient and study level can be passed along as well.

Implements [gdcm::BaseRootQuery](#).

## 10.194.4 Friends And Related Function Documentation

### 10.194.4.1 QueryFactory

```
friend class QueryFactory [friend]
```

The documentation for this class was generated from the following file:

- [gdcmMoveStudyRootQuery.h](#)

## 10.195 gdcm::MrProtocol Class Reference

Class for [MrProtocol](#).

```
#include <gdcmMrProtocol.h>
```

## Classes

- struct [Slice](#)
- struct [SliceArray](#)
- struct [Vector3](#)

## Public Member Functions

- [MrProtocol](#) ()
- [~MrProtocol](#) ()
- bool [FindMrProtocolByName](#) (const char \*name) const
- const char \* [GetMrProtocolByName](#) (const char \*name) const
- bool [GetSliceArray](#) ([MrProtocol::SliceArray](#) &sa) const
- int [GetVersion](#) () const
- bool [Load](#) (const [ByteValue](#) \*bv, const char \*str, int version)
- void [Print](#) (std::ostream &os) const

## Friends

- std::ostream & [operator<<](#) (std::ostream &\_os, const [MrProtocol](#) &d)

### 10.195.1 Detailed Description

Class for [MrProtocol](#).

#### Examples

[MrProtocol.cxx](#).

### 10.195.2 Constructor & Destructor Documentation

#### 10.195.2.1 MrProtocol()

```
gdcM::MrProtocol::MrProtocol ( )
```

#### 10.195.2.2 ~MrProtocol()

```
gdcM::MrProtocol::~~MrProtocol ( )
```

## 10.195.3 Member Function Documentation

### 10.195.3.1 FindMrProtocolByName()

```
bool gdcM::MrProtocol::FindMrProtocolByName (
    const char * name ) const
```

### 10.195.3.2 GetMrProtocolByName()

```
const char* gdcM::MrProtocol::GetMrProtocolByName (
    const char * name ) const
```

### 10.195.3.3 GetSliceArray()

```
bool gdcM::MrProtocol::GetSliceArray (
    MrProtocol::SliceArray & sa ) const
```

### 10.195.3.4 GetVersion()

```
int gdcM::MrProtocol::GetVersion ( ) const
```

### 10.195.3.5 Load()

```
bool gdcM::MrProtocol::Load (
    const ByteValue * bv,
    const char * str,
    int version )
```

### 10.195.3.6 Print()

```
void gdcM::MrProtocol::Print (
    std::ostream & os ) const
```

## 10.195.4 Friends And Related Function Documentation

### 10.195.4.1 operator<<

```
std::ostream& operator<< (  
    std::ostream & _os,  
    const MrProtocol & d ) [friend]
```

The documentation for this class was generated from the following file:

- [gdcmMrProtocol.h](#)

## 10.196 gdcm::network::NActionRQ Class Reference

[NActionRQ](#).

```
#include <gdcmNActionMessages.h>
```

Inheritance diagram for gdcm::network::NActionRQ:

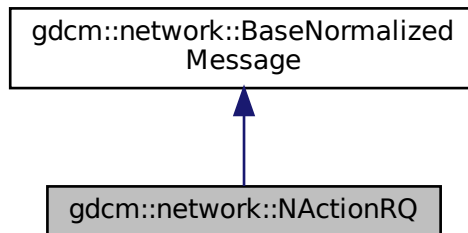

Collaboration diagram for gdcm::network::NActionRQ:

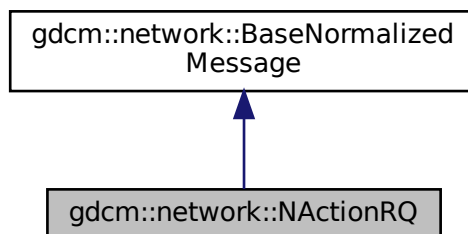

## Public Member Functions

- `std::vector< PresentationDataValue > ConstructPDV` (const [ULConnection](#) &*inConnection*, const [BaseQuery](#) \**inQuery*) override

### 10.196.1 Detailed Description

[NActionRQ](#).

this file defines the messages for the NAction action

### 10.196.2 Member Function Documentation

#### 10.196.2.1 ConstructPDV()

```
std::vector<PresentationDataValue> gdcM::network::NActionRQ::ConstructPDV (
    const ULConnection & inConnection,
    const BaseQuery * inQuery ) [override], [virtual]
```

Implements [gdcM::network::BaseNormalizedMessage](#).

The documentation for this class was generated from the following file:

- [gdcMNActionMessages.h](#)

## 10.197 gdcM::network::NActionRSP Class Reference

[NActionRSP](#) this file defines the messages for the NAction action.

```
#include <gdcMNActionMessages.h>
```

Inheritance diagram for `gdcM::network::NActionRSP`:

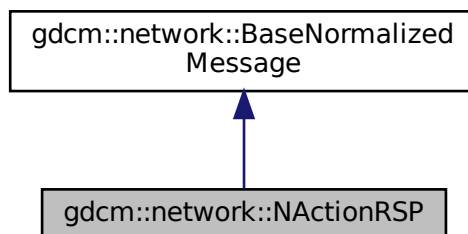



Collaboration diagram for gdcM::network::NActionRSP:

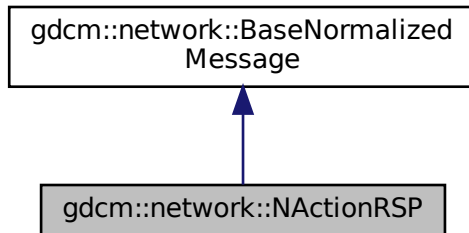

## Public Member Functions

- `std::vector< PresentationDataValue > ConstructPDVByDataSet (const DataSet *inDataSet)`

### 10.197.1 Detailed Description

[NActionRSP](#) this file defines the messages for the NAction action.

### 10.197.2 Member Function Documentation

#### 10.197.2.1 ConstructPDVByDataSet()

```
std::vector<PresentationDataValue> gdcM::network::NActionRSP::ConstructPDVByDataSet (
    const DataSet * inDataSet )
```

The documentation for this class was generated from the following file:

- [gdcMNActionMessages.h](#)

## 10.198 gdcmm::network::NCreateRQ Class Reference

[NCreateRQ](#).

```
#include <gdcmmNCreateMessages.h>
```

Inheritance diagram for gdcmm::network::NCreateRQ:

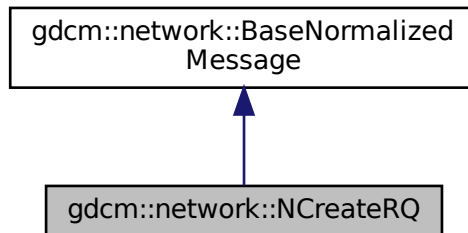

Collaboration diagram for gdcmm::network::NCreateRQ:

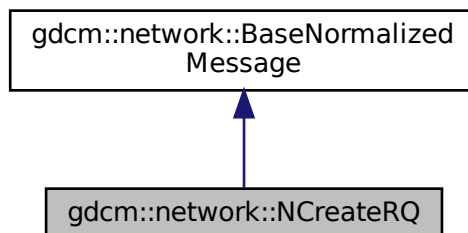

### Public Member Functions

- `std::vector< PresentationDataValue > ConstructPDV` (const [ULConnection](#) &inConnection, const [BaseQuery](#) \*inQuery) override

### 10.198.1 Detailed Description

[NCreateRQ](#).

this file defines the messages for the ncreate action

## 10.198.2 Member Function Documentation

### 10.198.2.1 ConstructPDV()

```
std::vector<PresentationDataValue> gdcM::network::NCreateRQ::ConstructPDV (
    const ULConnection & inConnection,
    const BaseQuery * inQuery ) [override], [virtual]
```

Implements [gdcM::network::BaseNormalizedMessage](#).

The documentation for this class was generated from the following file:

- [gdcMNCreateMessages.h](#)

## 10.199 gdcM::network::NCreateRSP Class Reference

[NCreateRSP](#) this file defines the messages for the ncreate action.

```
#include <gdcMNCreateMessages.h>
```

Inheritance diagram for gdcM::network::NCreateRSP:

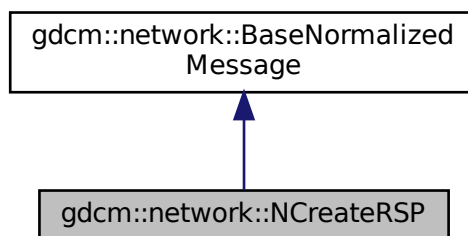

Collaboration diagram for `gdcm::network::NCreateRSP`:

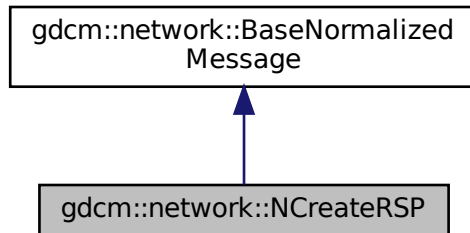

## Public Member Functions

- `std::vector< PresentationDataValue > ConstructPDVByDataSet` (const `DataSet *inDataSet`)

### 10.199.1 Detailed Description

[NCreateRSP](#) this file defines the messages for the ncreate action.

### 10.199.2 Member Function Documentation

#### 10.199.2.1 ConstructPDVByDataSet()

```
std::vector<PresentationDataValue> gdcm::network::NCreateRSP::ConstructPDVByDataSet (
    const DataSet * inDataSet )
```

The documentation for this class was generated from the following file:

- [gdcmNCreateMessages.h](#)

## 10.200 gdcM::network::NDeleteRQ Class Reference

[NDeleteRQ](#).

```
#include <gdcMNDeleteMessages.h>
```

Inheritance diagram for gdcM::network::NDeleteRQ:

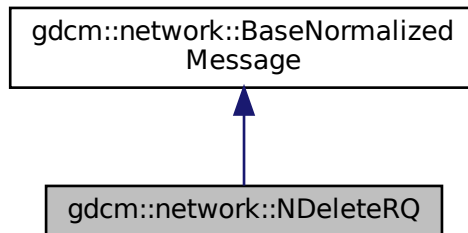

Collaboration diagram for gdcM::network::NDeleteRQ:

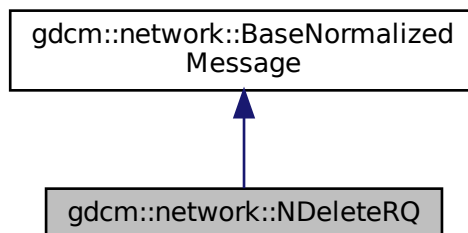

### Public Member Functions

- `std::vector< PresentationDataValue > ConstructPDV` (const [ULConnection](#) &inConnection, const [BaseQuery](#) \*inQuery) override

### 10.200.1 Detailed Description

[NDeleteRQ](#).

this file defines the messages for the ndelete action

## 10.200.2 Member Function Documentation

### 10.200.2.1 ConstructPDV()

```
std::vector<PresentationDataValue> gdcM::network::NDeleteRQ::ConstructPDV (
    const ULConnection & inConnection,
    const BaseQuery * inQuery ) [override], [virtual]
```

Implements [gdcM::network::BaseNormalizedMessage](#).

The documentation for this class was generated from the following file:

- [gdcMNDeleteMessages.h](#)

## 10.201 gdcM::network::NDeleteRSP Class Reference

[NDeleteRSP](#) this file defines the messages for the ndelete action.

```
#include <gdcMNDeleteMessages.h>
```

Inheritance diagram for gdcM::network::NDeleteRSP:

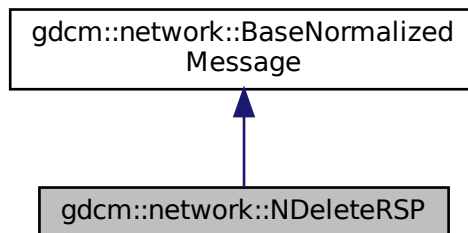

Collaboration diagram for gdcM::network::NDeleteRSP:

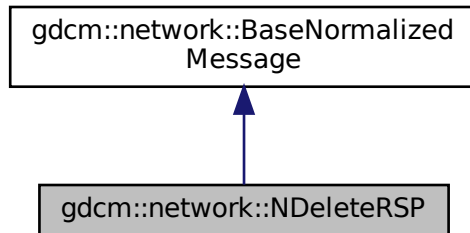

## Public Member Functions

- `std::vector< PresentationDataValue > ConstructPDVByDataSet (const DataSet *inDataSet)`

### 10.201.1 Detailed Description

[NDeleteRSP](#) this file defines the messages for the ndelete action.

### 10.201.2 Member Function Documentation

#### 10.201.2.1 ConstructPDVByDataSet()

```
std::vector<PresentationDataValue> gdcM::network::NDeleteRSP::ConstructPDVByDataSet (
    const DataSet * inDataSet )
```

The documentation for this class was generated from the following file:

- [gdcMNDeleteMessages.h](#)

## 10.202 gdcM::NestedModuleEntries Class Reference

Class for representing a [NestedModuleEntries](#).

```
#include <gdcMNestedModuleEntries.h>
```

Inheritance diagram for gdcM::NestedModuleEntries:

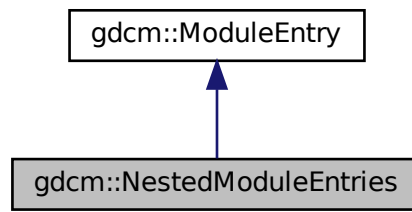

Collaboration diagram for gdcM::NestedModuleEntries:

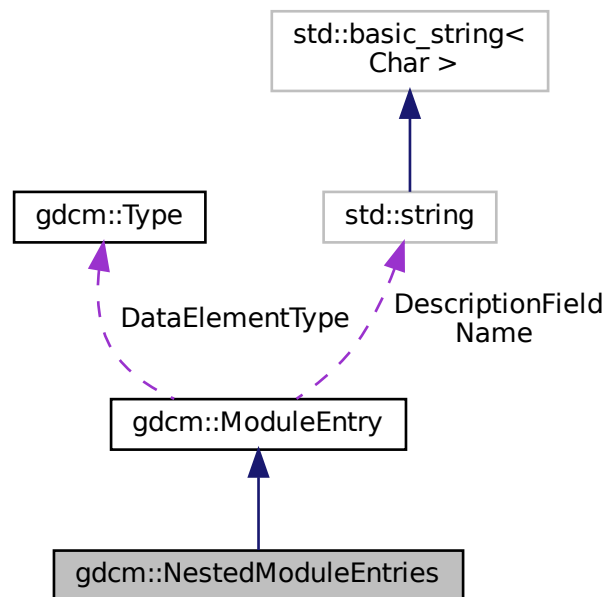



## Public Types

- typedef std::vector< [ModuleEntry](#) >::size\_type [SizeType](#)

## Public Member Functions

- [NestedModuleEntries](#) (const char \*name="", const char \*type="3", const char \*description="")
- void [AddModuleEntry](#) (const [ModuleEntry](#) &me)
- [ModuleEntry](#) & [GetModuleEntry](#) ([SizeType](#) idx)
- const [ModuleEntry](#) & [GetModuleEntry](#) ([SizeType](#) idx) const
- [SizeType](#) [GetNumberOfModuleEntries](#) ()

## Friends

- std::ostream & [operator<<](#) (std::ostream &\_os, const [NestedModuleEntries](#) &\_val)

## Additional Inherited Members

### 10.202.1 Detailed Description

Class for representing a [NestedModuleEntries](#).

#### Note

bla

#### See also

[ModuleEntry](#)

### 10.202.2 Member Typedef Documentation

#### 10.202.2.1 SizeType

```
typedef std::vector<ModuleEntry>::size_type gdcmm::NestedModuleEntries::SizeType
```

### 10.202.3 Constructor & Destructor Documentation

### 10.202.3.1 NestedModuleEntries()

```
gdcM::NestedModuleEntries::NestedModuleEntries (
    const char * name = "",
    const char * type = "3",
    const char * description = "" ) [inline]
```

## 10.202.4 Member Function Documentation

### 10.202.4.1 AddModuleEntry()

```
void gdcM::NestedModuleEntries::AddModuleEntry (
    const ModuleEntry & me ) [inline]
```

### 10.202.4.2 GetModuleEntry() [1/2]

```
ModuleEntry& gdcM::NestedModuleEntries::GetModuleEntry (
    SizeType idx ) [inline]
```

### 10.202.4.3 GetModuleEntry() [2/2]

```
const ModuleEntry& gdcM::NestedModuleEntries::GetModuleEntry (
    SizeType idx ) const [inline]
```

### 10.202.4.4 GetNumberOfModuleEntries()

```
SizeType gdcM::NestedModuleEntries::GetNumberOfModuleEntries ( ) [inline]
```

## 10.202.5 Friends And Related Function Documentation

### 10.202.5.1 operator<<

```
std::ostream& operator<< (
    std::ostream & _os,
    const NestedModuleEntries & _val ) [friend]
```

The documentation for this class was generated from the following file:

- [gdcmNestedModuleEntries.h](#)

## 10.203 gdcm::network::NEventReportRQ Class Reference

[NEventReportRQ](#).

```
#include <gdcmNEventReportMessages.h>
```

Inheritance diagram for gdcm::network::NEventReportRQ:

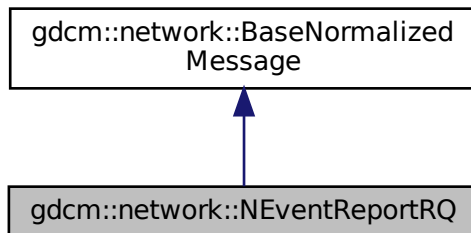

Collaboration diagram for gdcm::network::NEventReportRQ:

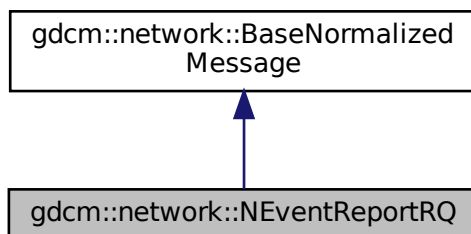

## Public Member Functions

- `std::vector< PresentationDataValue > ConstructPDV` (const [ULConnection](#) &*inConnection*, const [BaseQuery](#) \**inQuery*) override

### 10.203.1 Detailed Description

[NEventReportRQ](#).

this file defines the messages for the neventreport action

### 10.203.2 Member Function Documentation

#### 10.203.2.1 ConstructPDV()

```
std::vector<PresentationDataValue> gdc::network::NEventReportRQ::ConstructPDV (
    const ULConnection & inConnection,
    const BaseQuery * inQuery ) [override], [virtual]
```

Implements [gdc::network::BaseNormalizedMessage](#).

The documentation for this class was generated from the following file:

- [gdcNEventReportMessages.h](#)

## 10.204 gdc::network::NEventReportRSP Class Reference

[NEventReportRSP](#) this file defines the messages for the neventreport action.

```
#include <gdcNEventReportMessages.h>
```

Inheritance diagram for `gdc::network::NEventReportRSP`:

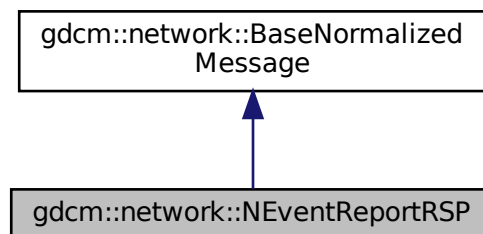

Collaboration diagram for gdcM::network::NEventReportRSP:

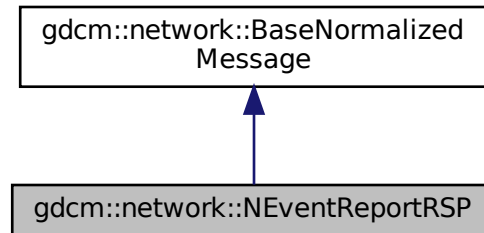

## Public Member Functions

- `std::vector< PresentationDataValue > ConstructPDVByDataSet` (const `DataSet` \*inDataSet)

### 10.204.1 Detailed Description

[NEventReportRSP](#) this file defines the messages for the neventreport action.

### 10.204.2 Member Function Documentation

#### 10.204.2.1 ConstructPDVByDataSet()

```
std::vector<PresentationDataValue> gdcM::network::NEventReportRSP::ConstructPDVByDataSet (
    const DataSet * inDataSet )
```

The documentation for this class was generated from the following file:

- [gdcMNEventReportMessages.h](#)

## 10.205 gdcmm::network::NGetRQ Class Reference

[NGetRQ](#).

```
#include <gdcmmNGetMessages.h>
```

Inheritance diagram for gdcmm::network::NGetRQ:

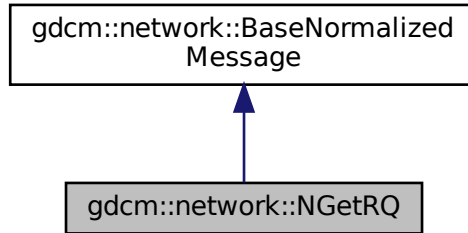

Collaboration diagram for gdcmm::network::NGetRQ:

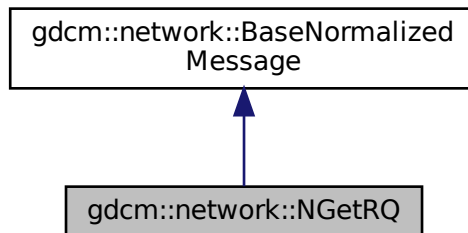

### Public Member Functions

- `std::vector< PresentationDataValue > ConstructPDV` (const [ULConnection](#) &inConnection, const [BaseQuery](#) \*inQuery) override

### 10.205.1 Detailed Description

[NGetRQ](#).

this file defines the messages for the nget action

## 10.205.2 Member Function Documentation

### 10.205.2.1 ConstructPDV()

```
std::vector<PresentationDataValue> gdcmm::network::NGetRQ::ConstructPDV (
    const ULConnection & inConnection,
    const BaseQuery * inQuery ) [override], [virtual]
```

Implements [gdcmm::network::BaseNormalizedMessage](#).

The documentation for this class was generated from the following file:

- [gdcmmNGetMessages.h](#)

## 10.206 gdcmm::network::NGetRSP Class Reference

[NGetRSP](#) this file defines the messages for the nget action.

```
#include <gdcmmNGetMessages.h>
```

Inheritance diagram for gdcmm::network::NGetRSP:

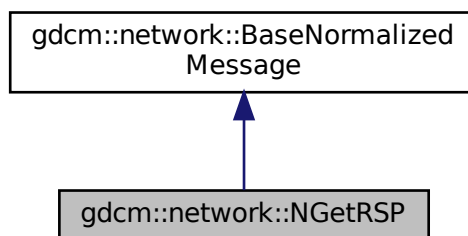

Collaboration diagram for `gdcm::network::NGetRSP`:

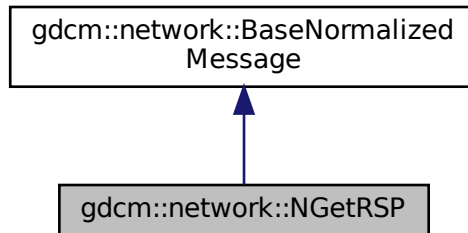

## Public Member Functions

- `std::vector< PresentationDataValue > ConstructPDVByDataSet` (`const DataSet *inDataSet`)

### 10.206.1 Detailed Description

[NGetRSP](#) this file defines the messages for the nget action.

### 10.206.2 Member Function Documentation

#### 10.206.2.1 ConstructPDVByDataSet()

```
std::vector<PresentationDataValue> gdcm::network::NGetRSP::ConstructPDVByDataSet (
    const DataSet * inDataSet )
```

The documentation for this class was generated from the following file:

- [gdcmNGetMessages.h](#)



## 10.207 gdcm::NoEvent Class Reference

```
#include <gdcmEvent.h>
```

Inheritance diagram for gdcm::NoEvent:

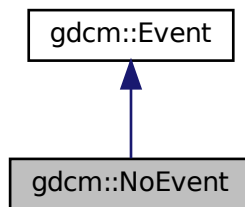

Collaboration diagram for gdcm::NoEvent:

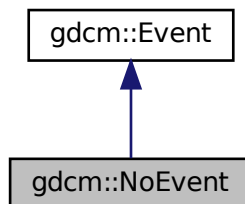

### Additional Inherited Members

#### 10.207.1 Detailed Description

Define some common GDCM events

The documentation for this class was generated from the following file:

- [gdcmEvent.h](#)

## 10.208 gdcmm::network::NormalizedMessageFactory Class Reference

```
#include <gdcmmNormalizedMessageFactory.h>
```

### Static Public Member Functions

- static std::vector< [PresentationDataValue](#) > [ConstructNAction](#) (const [ULConnection](#) &inConnection, const [BaseQuery](#) \*inQuery)
- static std::vector< [PresentationDataValue](#) > [ConstructNCreate](#) (const [ULConnection](#) &inConnection, const [BaseQuery](#) \*inQuery)
- static std::vector< [PresentationDataValue](#) > [ConstructNDelete](#) (const [ULConnection](#) &inConnection, const [BaseQuery](#) \*inQuery)
- static std::vector< [PresentationDataValue](#) > [ConstructNEventReport](#) (const [ULConnection](#) &inConnection, const [BaseQuery](#) \*inQuery)
- static std::vector< [PresentationDataValue](#) > [ConstructNGet](#) (const [ULConnection](#) &inConnection, const [BaseQuery](#) \*inQuery)
- static std::vector< [PresentationDataValue](#) > [ConstructNSet](#) (const [ULConnection](#) &inConnection, const [BaseQuery](#) \*inQuery)

### 10.208.1 Member Function Documentation

#### 10.208.1.1 ConstructNAction()

```
static std::vector<PresentationDataValue> gdcmm::network::NormalizedMessageFactory::Construct←
NAction (
    const ULConnection & inConnection,
    const BaseQuery * inQuery ) [static]
```

#### 10.208.1.2 ConstructNCreate()

```
static std::vector<PresentationDataValue> gdcmm::network::NormalizedMessageFactory::Construct←
NCreate (
    const ULConnection & inConnection,
    const BaseQuery * inQuery ) [static]
```

### 10.208.1.3 ConstructNDelete()

```
static std::vector<PresentationDataValue> gdcm::network::NormalizedMessageFactory::ConstructNDelete (
    const ULConnection & inConnection,
    const BaseQuery * inQuery ) [static]
```

### 10.208.1.4 ConstructNEventReport()

```
static std::vector<PresentationDataValue> gdcm::network::NormalizedMessageFactory::ConstructNEventReport (
    const ULConnection & inConnection,
    const BaseQuery * inQuery ) [static]
```

### 10.208.1.5 ConstructNGet()

```
static std::vector<PresentationDataValue> gdcm::network::NormalizedMessageFactory::ConstructNGet (
    const ULConnection & inConnection,
    const BaseQuery * inQuery ) [static]
```

### 10.208.1.6 ConstructNSet()

```
static std::vector<PresentationDataValue> gdcm::network::NormalizedMessageFactory::ConstructNSet (
    const ULConnection & inConnection,
    const BaseQuery * inQuery ) [static]
```

The documentation for this class was generated from the following file:

- [gdcmNormalizedMessageFactory.h](#)

## 10.209 gdcm::NormalizedNetworkFunctions Class Reference

Normalized Network Functions.

```
#include <gdcmNormalizedNetworkFunctions.h>
```

## Static Public Member Functions

- static [BaseQuery](#) \* [ConstructQuery](#) (const std::string &sopInstanceUID, const [DataSet](#) &queryds, [ENQueryType](#) queryType=[eCreateMMPS](#))
- static bool [NAction](#) (const char \*remote, uint16\_t portno, const [BaseQuery](#) \*query, std::vector< [DataSet](#) > &retDataSets, const char \*aetitle, const char \*call)
- static bool [NCreate](#) (const char \*remote, uint16\_t portno, [BaseQuery](#) \*query, std::vector< [DataSet](#) > &retDataSets, const char \*aetitle, const char \*call)
- static bool [NDelete](#) (const char \*remote, uint16\_t portno, const [BaseQuery](#) \*query, std::vector< [DataSet](#) > &retDataSets, const char \*aetitle, const char \*call)
- static bool [NEventReport](#) (const char \*remote, uint16\_t portno, const [BaseQuery](#) \*query, std::vector< [DataSet](#) > &retDataSets, const char \*aetitle, const char \*call)
- static bool [NGet](#) (const char \*remote, uint16\_t portno, const [BaseQuery](#) \*query, std::vector< [DataSet](#) > &retDataSets, const char \*aetitle, const char \*call)
- static bool [NSet](#) (const char \*remote, uint16\_t portno, const [BaseQuery](#) \*query, std::vector< [DataSet](#) > &retDataSets, const char \*aetitle, const char \*call)

### 10.209.1 Detailed Description

Normalized Network Functions.

These functions provide a generic API to the DICOM functions implemented in GDCM. Advanced users can use this code as a template for building their own versions of these functions (for instance, to provide progress bars or some other way of handling returned query information), but for most users, these functions should be sufficient to interface with a PACS to a local machine. Note that these functions are not contained within a static class or some other class-style interface, because multiple connections can be instantiated in the same program. The DICOM standard is much more function oriented rather than class oriented in this instance, so the design of this API reflects that functional approach. These functions implements the following SCU operations:

- N-EVENT-REPORT
- N-GET
- N-SET
- N-ACTION
- N-CREATE
- N-DELETE

### 10.209.2 Member Function Documentation

#### 10.209.2.1 ConstructQuery()

```
static BaseQuery* gdcM::NormalizedNetworkFunctions::ConstructQuery (
    const std::string & sopInstanceUID,
    const DataSet & queryds,
    ENQueryType queryType = eCreateMMPS ) [static]
```

### 10.209.2.2 NAction()

```
static bool gdcmm::NormalizedNetworkFunctions::NAction (
    const char * remote,
    uint16_t portno,
    const BaseQuery * query,
    std::vector< DataSet > & retDataSets,
    const char * aetitle,
    const char * call ) [static]
```

### 10.209.2.3 NCreate()

```
static bool gdcmm::NormalizedNetworkFunctions::NCreate (
    const char * remote,
    uint16_t portno,
    BaseQuery * query,
    std::vector< DataSet > & retDataSets,
    const char * aetitle,
    const char * call ) [static]
```

### 10.209.2.4 NDelete()

```
static bool gdcmm::NormalizedNetworkFunctions::NDelete (
    const char * remote,
    uint16_t portno,
    const BaseQuery * query,
    std::vector< DataSet > & retDataSets,
    const char * aetitle,
    const char * call ) [static]
```

### 10.209.2.5 NEventReport()

```
static bool gdcmm::NormalizedNetworkFunctions::NEventReport (
    const char * remote,
    uint16_t portno,
    const BaseQuery * query,
    std::vector< DataSet > & retDataSets,
    const char * aetitle,
    const char * call ) [static]
```

### 10.209.2.6 NGet()

```
static bool gdcM::NormalizedNetworkFunctions::NGet (
    const char * remote,
    uint16_t portno,
    const BaseQuery * query,
    std::vector< DataSet > & retDataSets,
    const char * aetitle,
    const char * call ) [static]
```

### 10.209.2.7 NSet()

```
static bool gdcM::NormalizedNetworkFunctions::NSet (
    const char * remote,
    uint16_t portno,
    const BaseQuery * query,
    std::vector< DataSet > & retDataSets,
    const char * aetitle,
    const char * call ) [static]
```

The documentation for this class was generated from the following file:

- [gdcMNormalizedNetworkFunctions.h](#)

## 10.210 gdcM::network::NSetRQ Class Reference

[NSetRQ](#).

```
#include <gdcMNSetMessages.h>
```

Inheritance diagram for gdcM::network::NSetRQ:

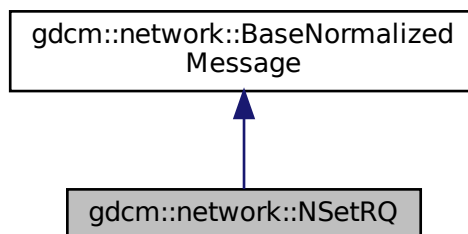

Collaboration diagram for gdcM::network::NSetRQ:

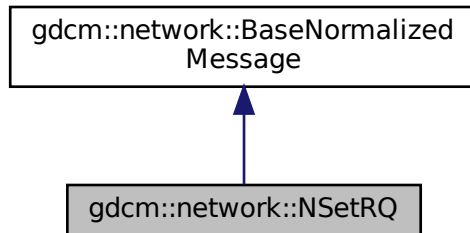

## Public Member Functions

- `std::vector< PresentationDataValue > ConstructPDV` (const [ULConnection](#) &inConnection, const [BaseQuery](#) \*inQuery) override

### 10.210.1 Detailed Description

[NSetRQ](#).

this file defines the messages for the nset action

### 10.210.2 Member Function Documentation

#### 10.210.2.1 ConstructPDV()

```
std::vector<PresentationDataValue> gdcM::network::NSetRQ::ConstructPDV (
    const ULConnection & inConnection,
    const BaseQuery * inQuery ) [override], [virtual]
```

Implements [gdcM::network::BaseNormalizedMessage](#).

The documentation for this class was generated from the following file:

- [gdcMNSetMessages.h](#)

## 10.211 gdcM::network::NSetRSP Class Reference

[NSetRSP](#) this file defines the messages for the nset action.

```
#include <gdcMNSetMessages.h>
```

Inheritance diagram for gdcM::network::NSetRSP:

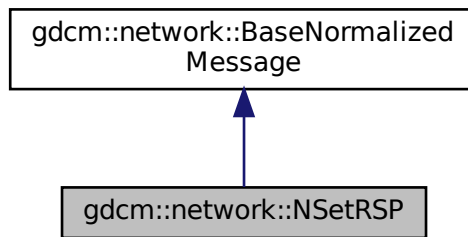

Collaboration diagram for gdcM::network::NSetRSP:

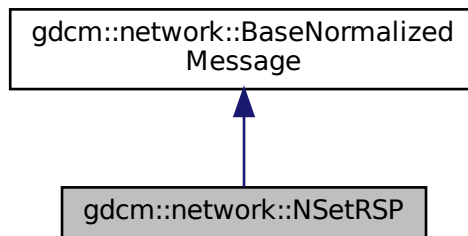

### Public Member Functions

- `std::vector< PresentationDataValue > ConstructPDVByDataSet` (const [DataSet](#) \*inDataSet)

#### 10.211.1 Detailed Description

[NSetRSP](#) this file defines the messages for the nset action.



## 10.211.2 Member Function Documentation

### 10.211.2.1 ConstructPDVByDataSet()

```
std::vector<PresentationDataValue> gdcm::network::NSetRSP::ConstructPDVByDataSet (
    const DataSet * inDataSet )
```

The documentation for this class was generated from the following file:

- [gdcmNSetMessages.h](#)

## 10.212 gdcm::Object Class Reference

[Object.](#)

```
#include <gdcmObject.h>
```

Inheritance diagram for `gdcm::Object`:

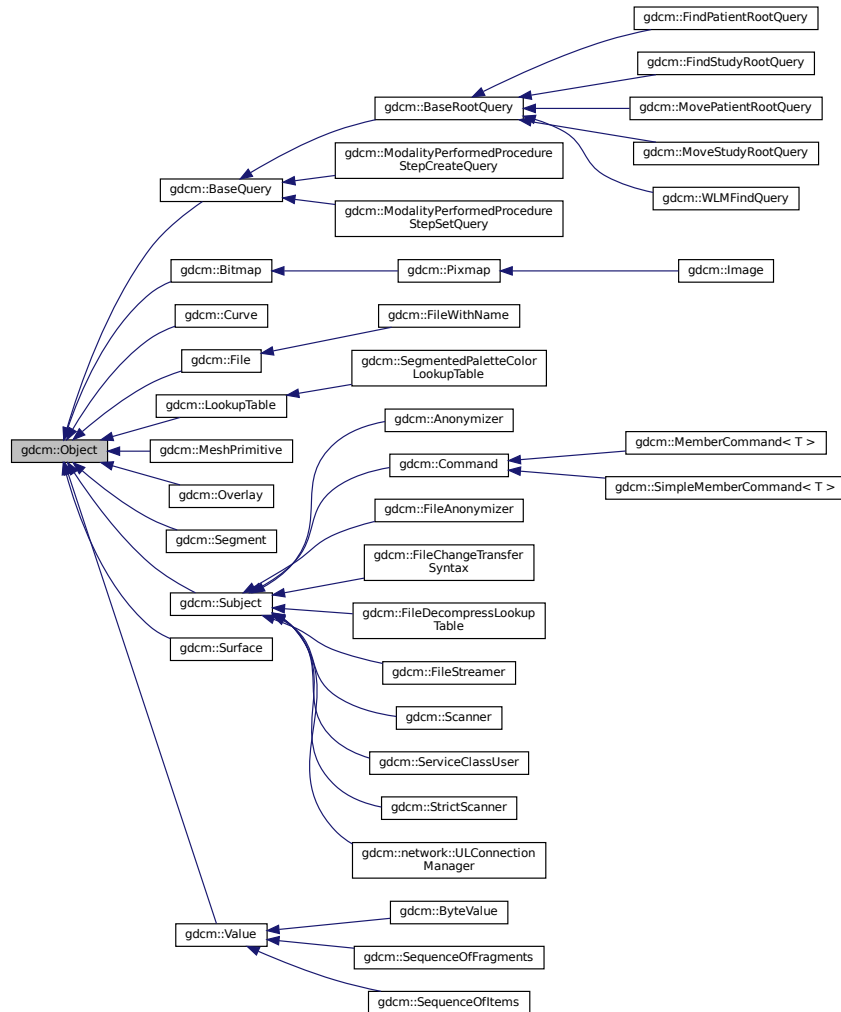

## Public Member Functions

- `Object ()`
- `Object (const Object &)`  
*Special requirement for copy/cstor, assignment operator.*
- `virtual ~Object ()`
- `void operator= (const Object &)`
- `virtual void Print (std::ostream &) const`

## Protected Member Functions

- `void Register ()`
- `void UnRegister ()`

## Friends

- `std::ostream & operator<<` (`std::ostream &os, const Object &obj`)
- `template<class ObjectType >`  
`class SmartPointer`

### 10.212.1 Detailed Description

[Object](#).

#### Note

main superclass for object that want to use [SmartPointer](#) invasive ref counting system

#### See also

[SmartPointer](#)

### 10.212.2 Constructor & Destructor Documentation

#### 10.212.2.1 [Object\(\)](#) [1/2]

```
gdcmm::Object::Object ( ) [inline]
```

#### 10.212.2.2 [~Object\(\)](#)

```
virtual gdcmm::Object::~~Object ( ) [inline], [virtual]
```

#### 10.212.2.3 [Object\(\)](#) [2/2]

```
gdcmm::Object::Object (
    const Object & ) [inline]
```

Special requirement for copy/cstor, assignment operator.

### 10.212.3 Member Function Documentation

#### 10.212.3.1 operator=()

```
void gdcM::Object::operator= (
    const Object & ) [inline]
```

#### 10.212.3.2 Print()

```
virtual void gdcM::Object::Print (
    std::ostream & ) const [inline], [virtual]
```

Reimplemented in [gdcM::BaseQuery](#), [gdcM::StrictScanner](#), [gdcM::Scanner](#), [gdcM::Image](#), [gdcM::SequenceOfItems](#), [gdcM::SequenceOfFragments](#), [gdcM::ByteValue](#), [gdcM::SegmentedPaletteColorLookupTable](#), [gdcM::Pixmap](#), [gdcM::Overlay](#), [gdcM::LookupTable](#), [gdcM::Curve](#), and [gdcM::Bitmap](#).

#### Examples

[ReadAndDumpDICOMDIR.cxx](#).

#### 10.212.3.3 Register()

```
void gdcM::Object::Register ( ) [inline], [protected]
```

#### 10.212.3.4 UnRegister()

```
void gdcM::Object::UnRegister ( ) [inline], [protected]
```

### 10.212.4 Friends And Related Function Documentation

#### 10.212.4.1 operator<<

```
std::ostream& operator<< (  
    std::ostream & os,  
    const Object & obj ) [friend]
```

#### 10.212.4.2 SmartPointer

```
template<class ObjectType >  
friend class SmartPointer [friend]
```

The documentation for this class was generated from the following file:

- [gdcMObject.h](#)

### 10.213 gdcM::OpenSSLCryptoFactory Class Reference

```
#include <gdcMOpenSSLCryptoFactory.h>
```

Inheritance diagram for gdcM::OpenSSLCryptoFactory:

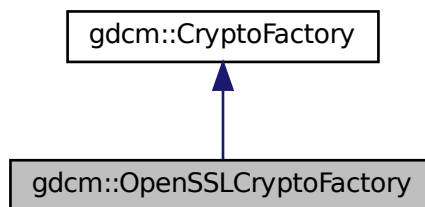

Collaboration diagram for gdcM::OpenSSLCryptoFactory:

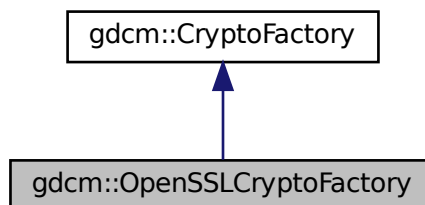

## Public Member Functions

- [OpenSSLCryptoFactory](#) ([CryptoLib](#) id)
- [CryptographicMessageSyntax](#) \* [CreateCMSProvider](#) ()

## Protected Member Functions

- void [InitOpenSSL](#) ()

## Additional Inherited Members

### 10.213.1 Constructor & Destructor Documentation

#### 10.213.1.1 OpenSSLCryptoFactory()

```
gdcmm::OpenSSLCryptoFactory::OpenSSLCryptoFactory (
    CryptoLib id ) [inline]
```

References [gdcmDebugMacro](#).

### 10.213.2 Member Function Documentation

#### 10.213.2.1 CreateCMSProvider()

```
CryptographicMessageSyntax* gdcmm::OpenSSLCryptoFactory::CreateCMSProvider ( ) [inline], [virtual]
```

Implements [gdcmm::CryptoFactory](#).

#### 10.213.2.2 InitOpenSSL()

```
void gdcmm::OpenSSLCryptoFactory::InitOpenSSL ( ) [protected]
```

The documentation for this class was generated from the following file:

- [gdcmmOpenSSLCryptoFactory.h](#)

## 10.214 gdcM::OpenSSLCryptographicMessageSyntax Class Reference

```
#include <gdcMOpenSSLCryptographicMessageSyntax.h>
```

Inheritance diagram for gdcM::OpenSSLCryptographicMessageSyntax:

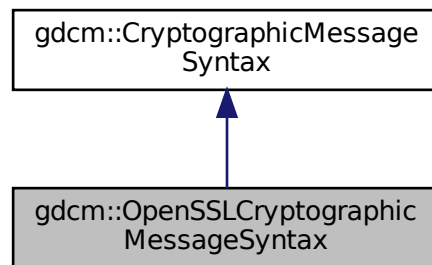

Collaboration diagram for gdcM::OpenSSLCryptographicMessageSyntax:

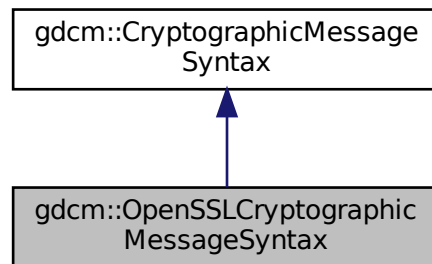

### Public Member Functions

- [OpenSSLCryptographicMessageSyntax \(\)](#)
- [~OpenSSLCryptographicMessageSyntax \(\)](#)
- bool [Decrypt](#) (char \*output, size\_t &outlen, const char \*array, size\_t len) const  
*decrypt content from a PKCS#7 envelopedData structure*
- bool [Encrypt](#) (char \*output, size\_t &outlen, const char \*array, size\_t len) const  
*create a CMS envelopedData structure*

- [CipherTypes GetCipherType](#) () const
- bool [ParseCertificateFile](#) (const char \*filename)
- bool [ParseKeyFile](#) (const char \*filename)
- void [SetCipherType](#) ([CipherTypes](#) type)
- bool [SetPassword](#) (const char \*pass, size\_t passLen)

## Additional Inherited Members

### 10.214.1 Constructor & Destructor Documentation

#### 10.214.1.1 [OpenSSLCryptographicMessageSyntax\(\)](#)

```
gdcM::OpenSSLCryptographicMessageSyntax::OpenSSLCryptographicMessageSyntax ( )
```

#### 10.214.1.2 [~OpenSSLCryptographicMessageSyntax\(\)](#)

```
gdcM::OpenSSLCryptographicMessageSyntax::~~OpenSSLCryptographicMessageSyntax ( )
```

### 10.214.2 Member Function Documentation

#### 10.214.2.1 [Decrypt\(\)](#)

```
bool gdcM::OpenSSLCryptographicMessageSyntax::Decrypt (
    char * output,
    size_t & outlen,
    const char * array,
    size_t len ) const [virtual]
```

decrypt content from a PKCS#7 envelopedData structure

Implements [gdcM::CryptographicMessageSyntax](#).



### 10.214.2.2 Encrypt()

```
bool gdcM::OpenSSLCryptographicMessageSyntax::Encrypt (
    char * output,
    size_t & outlen,
    const char * array,
    size_t len ) const [virtual]
```

create a CMS envelopedData structure

Implements [gdcM::CryptographicMessageSyntax](#).

### 10.214.2.3 GetCipherType()

```
CipherTypes gdcM::OpenSSLCryptographicMessageSyntax::GetCipherType ( ) const [virtual]
```

Implements [gdcM::CryptographicMessageSyntax](#).

### 10.214.2.4 ParseCertificateFile()

```
bool gdcM::OpenSSLCryptographicMessageSyntax::ParseCertificateFile (
    const char * filename ) [virtual]
```

Implements [gdcM::CryptographicMessageSyntax](#).

### 10.214.2.5 ParseKeyFile()

```
bool gdcM::OpenSSLCryptographicMessageSyntax::ParseKeyFile (
    const char * filename ) [virtual]
```

Implements [gdcM::CryptographicMessageSyntax](#).

### 10.214.2.6 SetCipherType()

```
void gdcM::OpenSSLCryptographicMessageSyntax::SetCipherType (
    CipherTypes type ) [virtual]
```

Set Cipher [Type](#). Default is: AES256\_CIPHER

Implements [gdcM::CryptographicMessageSyntax](#).

### 10.214.2.7 SetPassword()

```
bool gdcM::OpenSSLCryptographicMessageSyntax::SetPassword (
    const char * pass,
    size_t passLen ) [virtual]
```

Implements [gdcM::CryptographicMessageSyntax](#).

The documentation for this class was generated from the following file:

- [gdcMOpenSSLCryptographicMessageSyntax.h](#)

## 10.215 gdcM::OpenSSLP7CryptoFactory Class Reference

```
#include <gdcMOpenSSLP7CryptoFactory.h>
```

Inheritance diagram for gdcM::OpenSSLP7CryptoFactory:

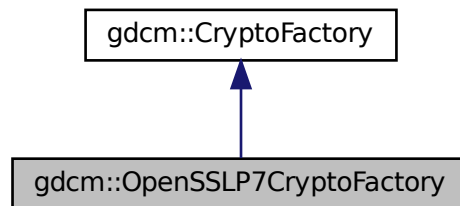

Collaboration diagram for gdcM::OpenSSLP7CryptoFactory:

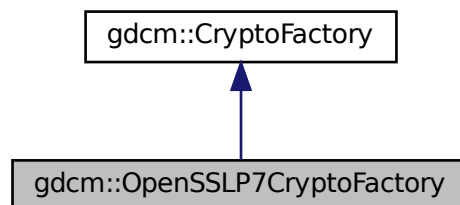

## Public Member Functions

- [OpenSSLP7CryptoFactory](#) ([CryptoLib](#) id)
- [CryptographicMessageSyntax](#) \* [CreateCMSProvider](#) ()

## Additional Inherited Members

### 10.215.1 Constructor & Destructor Documentation

#### 10.215.1.1 OpenSSLP7CryptoFactory()

```
gdcM::OpenSSLP7CryptoFactory::OpenSSLP7CryptoFactory (  
    CryptoLib id ) [inline]
```

References [gdcMDebugMacro](#).

### 10.215.2 Member Function Documentation

#### 10.215.2.1 CreateCMSProvider()

```
CryptographicMessageSyntax* gdcM::OpenSSLP7CryptoFactory::CreateCMSProvider ( ) [inline], [virtual]
```

Implements [gdcM::CryptoFactory](#).

The documentation for this class was generated from the following file:

- [gdcMOpenSSLP7CryptoFactory.h](#)

## 10.216 gdcM::OpenSSLP7CryptographicMessageSyntax Class Reference

```
#include <gdcMOpenSSLP7CryptographicMessageSyntax.h>
```

Inheritance diagram for gdcM::OpenSSLP7CryptographicMessageSyntax:

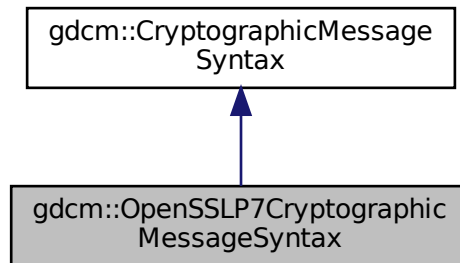

Collaboration diagram for gdcM::OpenSSLP7CryptographicMessageSyntax:

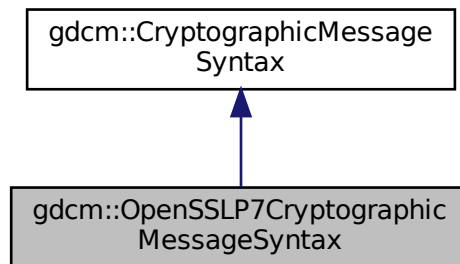

### Public Member Functions

- [OpenSSLP7CryptographicMessageSyntax \(\)](#)
- [~OpenSSLP7CryptographicMessageSyntax \(\)](#)
- bool [Decrypt](#) (char \*output, size\_t &outlen, const char \*array, size\_t len) const  
*decrypt content from a PKCS#7 envelopedData structure*
- bool [Encrypt](#) (char \*output, size\_t &outlen, const char \*array, size\_t len) const  
*create a PKCS#7 envelopedData structure*

- [CipherTypes](#) [GetCipherType](#) () const
- bool [ParseCertificateFile](#) (const char \*filename)
- bool [ParseKeyFile](#) (const char \*filename)
- void [SetCipherType](#) ([CipherTypes](#) type)
- bool [SetPassword](#) (const char \*, size\_t)

## Additional Inherited Members

### 10.216.1 Detailed Description

Class for [CryptographicMessageSyntax](#) encryption. This is just a simple wrapper around openssl PKCS7\_encrypt functionalities

See online documentation [http://www.openssl.org/docs/crypto/PKCS7\\_encrypt.html](http://www.openssl.org/docs/crypto/PKCS7_encrypt.html)

### 10.216.2 Constructor & Destructor Documentation

#### 10.216.2.1 OpenSSLP7CryptographicMessageSyntax()

```
gdcmm::OpenSSLP7CryptographicMessageSyntax::OpenSSLP7CryptographicMessageSyntax ( )
```

#### 10.216.2.2 ~OpenSSLP7CryptographicMessageSyntax()

```
gdcmm::OpenSSLP7CryptographicMessageSyntax::~~OpenSSLP7CryptographicMessageSyntax ( )
```

### 10.216.3 Member Function Documentation

#### 10.216.3.1 Decrypt()

```
bool gdcmm::OpenSSLP7CryptographicMessageSyntax::Decrypt (
    char * output,
    size_t & outlen,
    const char * array,
    size_t len ) const [virtual]
```

decrypt content from a PKCS#7 envelopedData structure

Implements [gdcmm::CryptographicMessageSyntax](#).

### 10.216.3.2 Encrypt()

```
bool gdcM::OpenSSLP7CryptographicMessageSyntax::Encrypt (
    char * output,
    size_t & outlen,
    const char * array,
    size_t len ) const [virtual]
```

create a PKCS#7 envelopedData structure

Implements [gdcM::CryptographicMessageSyntax](#).

### 10.216.3.3 GetCipherType()

```
CipherTypes gdcM::OpenSSLP7CryptographicMessageSyntax::GetCipherType ( ) const [virtual]
```

Implements [gdcM::CryptographicMessageSyntax](#).

### 10.216.3.4 ParseCertificateFile()

```
bool gdcM::OpenSSLP7CryptographicMessageSyntax::ParseCertificateFile (
    const char * filename ) [virtual]
```

Implements [gdcM::CryptographicMessageSyntax](#).

### 10.216.3.5 ParseKeyFile()

```
bool gdcM::OpenSSLP7CryptographicMessageSyntax::ParseKeyFile (
    const char * filename ) [virtual]
```

Implements [gdcM::CryptographicMessageSyntax](#).

### 10.216.3.6 SetCipherType()

```
void gdcM::OpenSSLP7CryptographicMessageSyntax::SetCipherType (
    CipherTypes type ) [virtual]
```

Set Cipher [Type](#). Default is: AES256\_CIPHER

Implements [gdcM::CryptographicMessageSyntax](#).

### 10.216.3.7 SetPassword()

```
bool gdcm::OpenSSL7CryptographicMessageSyntax::SetPassword (
    const char * ,
    size_t ) [inline], [virtual]
```

Implements [gdcm::CryptographicMessageSyntax](#).

References [gdcmWarningMacro](#).

The documentation for this class was generated from the following file:

- [gdcmOpenSSL7CryptographicMessageSyntax.h](#)

## 10.217 gdcm::Orientation Class Reference

class to handle [Orientation](#)

```
#include <gdcmOrientation.h>
```

### Public Types

- enum [OrientationType](#) {  
[UNKNOWN](#) ,  
[AXIAL](#) ,  
[CORONAL](#) ,  
[SAGITTAL](#) ,  
[OBLIQUE](#) }

### Public Member Functions

- [Orientation](#) ()
- [~Orientation](#) ()
- void [Print](#) (std::ostream &) const  
*Print.*

### Static Public Member Functions

- static const char \* [GetLabel](#) ([OrientationType](#) type)  
*Return the label of an Orientation.*
- static double [GetObliquityThresholdCosineValue](#) ()
- static [OrientationType](#) [GetType](#) (const double dircos[6])
- static void [SetObliquityThresholdCosineValue](#) (double val)  
*ObliquityThresholdCosineValue stuff.*

## Static Protected Member Functions

- static char [GetMajorAxisFromPatientRelativeDirectionCosine](#) (double x, double y, double z)

## Friends

- std::ostream & [operator<<](#) (std::ostream &\_os, const [Orientation](#) &o)

### 10.217.1 Detailed Description

class to handle [Orientation](#)

### 10.217.2 Member Enumeration Documentation

#### 10.217.2.1 OrientationType

enum [gdc::Orientation::OrientationType](#)

Enumerator

UNKNOWN	
AXIAL	
CORONAL	
SAGITTAL	
OBLIQUE	

### 10.217.3 Constructor & Destructor Documentation

#### 10.217.3.1 Orientation()

`gdc::Orientation::Orientation ( )`

#### 10.217.3.2 ~Orientation()

`gdc::Orientation::~~Orientation ( )`



## 10.217.4 Member Function Documentation

### 10.217.4.1 GetLabel()

```
static const char* gdcm::Orientation::GetLabel (
    OrientationType type ) [static]
```

Return the label of an [Orientation](#).

#### Examples

[FixOrientation.cxx](#).

### 10.217.4.2 GetMajorAxisFromPatientRelativeDirectionCosine()

```
static char gdcm::Orientation::GetMajorAxisFromPatientRelativeDirectionCosine (
    double x,
    double y,
    double z ) [static], [protected]
```

### 10.217.4.3 GetObliquityThresholdCosineValue()

```
static double gdcm::Orientation::GetObliquityThresholdCosineValue ( ) [static]
```

### 10.217.4.4 GetType()

```
static OrientationType gdcm::Orientation::GetType (
    const double dircos[6] ) [static]
```

Return the type of orientation from a direction cosines Input is an array of 6 double

#### Examples

[FixOrientation.cxx](#).

#### 10.217.4.5 Print()

```
void gdcM::Orientation::Print (
    std::ostream & ) const
```

Print.

#### 10.217.4.6 SetObliquityThresholdCosineValue()

```
static void gdcM::Orientation::SetObliquityThresholdCosineValue (
    double val ) [static]
```

ObliquityThresholdCosineValue stuff.

### 10.217.5 Friends And Related Function Documentation

#### 10.217.5.1 operator<<

```
std::ostream& operator<< (
    std::ostream & _os,
    const Orientation & o ) [friend]
```

The documentation for this class was generated from the following file:

- [gdcMOrientation.h](#)

### 10.218 gdcM::Overlay Class Reference

[Overlay](#) class.

```
#include <gdcMOverlay.h>
```

Inheritance diagram for gdcm::Overlay:

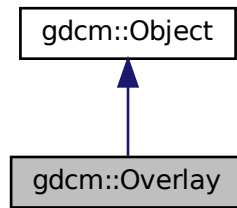

Collaboration diagram for gdcm::Overlay:

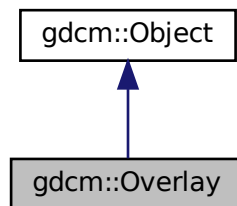

## Public Types

- enum `OverlayType` {  
    `Invalid` = 0 ,  
    `Graphics` = 1 ,  
    `ROI` = 2 }

## Public Member Functions

- `Overlay` ()
- `Overlay` (`Overlay` const &ov)
- `~Overlay` () override
- void `Decompress` (std::ostream &os) const  
    *Decode the internal OverlayData (packed bits) into unpacked representation.*
- unsigned short `GetBitPosition` () const  
    *return bit position*

- unsigned short [GetBitsAllocated](#) () const  
*return bits allocated*
- unsigned short [GetColumns](#) () const  
*get columns*
- const char \* [GetDescription](#) () const  
*get description*
- unsigned short [GetGroup](#) () const  
*Get Group number.*
- const signed short \* [GetOrigin](#) () const  
*get origin*
- const [ByteValue](#) & [GetOverlayData](#) () const
- unsigned short [GetRows](#) () const  
*get rows*
- const char \* [GetType](#) () const  
*get type*
- [OverlayType](#) [GetTypeAsEnum](#) () const
- bool [GetUnpackBuffer](#) (char \*buffer, size\_t len) const
- size\_t [GetUnpackBufferLength](#) () const
- bool [GrabOverlayFromPixelData](#) ([DataSet](#) const &ds)
- bool [IsEmpty](#) () const  
*Return whether or not the [Overlay](#) is empty:*
- bool [IsInPixelData](#) () const  
*return if the [Overlay](#) is stored in the pixel data or not*
- void [IsInPixelData](#) (bool b)  
*Set whether or no the [OverlayData](#) is in the [Pixel Data](#):*
- bool [IsZero](#) () const  
*return true if all bits are set to 0*
- [Overlay](#) & [operator=](#) ([Overlay](#) const &ov)
- void [Print](#) (std::ostream &) const override  
*Print.*
- void [SetBitPosition](#) (unsigned short bitposition)  
*set bit position*
- void [SetBitsAllocated](#) (unsigned short bitsallocated)  
*set bits allocated*
- void [SetColumns](#) (unsigned short columns)  
*set columns*
- void [SetDescription](#) (const char \*description)  
*set description*
- void [SetFrameOrigin](#) (unsigned short frameorigin)  
*set frame origin*
- void [SetGroup](#) (unsigned short group)  
*Set Group number.*
- void [SetNumberOfFrames](#) (unsigned int numberofframes)  
*set number of frames*
- void [SetOrigin](#) (const signed short origin[2])  
*set origin*
- void [SetOverlay](#) (const char \*array, size\_t length)

- set overlay from byte array + length*
- void [SetRows](#) (unsigned short rows)  
*set rows*
- void [SetType](#) (const char \*type)  
*set type*
- void [Update](#) (const [DataElement](#) &de)  
*Update overlay from data element de:*

## Static Public Member Functions

- static const char \* [GetOverlayTypeAsString](#) ([OverlayType](#) ot)
- static [OverlayType](#) [GetOverlayTypeFromString](#) (const char \*)

## Additional Inherited Members

### 10.218.1 Detailed Description

[Overlay](#) class.

#### Note

see [AreOverlaysInPixelData](#)

**Todo** Is there actually any way to recognize an overlay ? On images with multiple overlay I do not see any way to differentiate them (other than the group tag).

Example:

### 10.218.2 Member Enumeration Documentation

#### 10.218.2.1 OverlayType

```
enum gdcm::Overlay::OverlayType
```

#### Enumerator

Invalid	
Graphics	
ROI	

## 10.218.3 Constructor & Destructor Documentation

### 10.218.3.1 Overlay() [1/2]

```
gdcmm::Overlay::Overlay ( )
```

### 10.218.3.2 ~Overlay()

```
gdcmm::Overlay::~Overlay ( ) [override]
```

### 10.218.3.3 Overlay() [2/2]

```
gdcmm::Overlay::Overlay (
    Overlay const & ov )
```

## 10.218.4 Member Function Documentation

### 10.218.4.1 Decompress()

```
void gdcmm::Overlay::Decompress (
    std::ostream & os ) const
```

Decode the internal OverlayData (packed bits) into unpacked representation.

### 10.218.4.2 GetBitPosition()

```
unsigned short gdcmm::Overlay::GetBitPosition ( ) const
```

return bit position

#### 10.218.4.3 GetBitsAllocated()

```
unsigned short gdcm::Overlay::GetBitsAllocated ( ) const
```

return bits allocated

#### 10.218.4.4 GetColumns()

```
unsigned short gdcm::Overlay::GetColumns ( ) const
```

get columns

#### 10.218.4.5 GetDescription()

```
const char* gdcm::Overlay::GetDescription ( ) const
```

get description

#### 10.218.4.6 GetGroup()

```
unsigned short gdcm::Overlay::GetGroup ( ) const
```

Get Group number.

#### 10.218.4.7 GetOrigin()

```
const signed short* gdcm::Overlay::GetOrigin ( ) const
```

get origin

#### 10.218.4.8 GetOverlayData()

```
const ByteValue& gdcm::Overlay::GetOverlayData ( ) const
```

Return the [Overlay](#) Data as [ByteValue](#): Not thread safe

#### 10.218.4.9 GetOverlayTypeAsString()

```
static const char* gdcm::Overlay::GetOverlayTypeAsString (
    OverlayType ot ) [static]
```

#### 10.218.4.10 GetOverlayTypeFromString()

```
static OverlayType gdcm::Overlay::GetOverlayTypeFromString (
    const char * ) [static]
```

#### 10.218.4.11 GetRows()

```
unsigned short gdcm::Overlay::GetRows ( ) const
```

get rows

#### 10.218.4.12 GetType()

```
const char* gdcm::Overlay::GetType ( ) const
```

get type

#### 10.218.4.13 GetTypeAsEnum()

```
OverlayType gdcm::Overlay::GetTypeAsEnum ( ) const
```

#### 10.218.4.14 GetUnpackBuffer()

```
bool gdcm::Overlay::GetUnpackBuffer (
    char * buffer,
    size_t len ) const
```

Retrieve the unpack buffer for [Overlay](#). This is an error if the size is below [GetUnpackBufferLength\(\)](#)



#### 10.218.4.15 GetUnpackBufferLength()

```
size_t gdcm::Overlay::GetUnpackBufferLength ( ) const
```

Retrieve the size of the buffer needed to hold the [Overlay](#) as specified by Col & Row parameters

#### 10.218.4.16 GrabOverlayFromPixelData()

```
bool gdcm::Overlay::GrabOverlayFromPixelData (
    DataSet const & ds )
```

#### 10.218.4.17 IsEmpty()

```
bool gdcm::Overlay::IsEmpty ( ) const
```

Return whether or not the [Overlay](#) is empty:

#### 10.218.4.18 IsInPixelData() [1/2]

```
bool gdcm::Overlay::IsInPixelData ( ) const
```

return if the [Overlay](#) is stored in the pixel data or not

#### 10.218.4.19 IsInPixelData() [2/2]

```
void gdcm::Overlay::IsInPixelData (
    bool b )
```

Set whether or no the OverlayData is in the Pixel Data:

#### 10.218.4.20 IsZero()

```
bool gdcm::Overlay::IsZero ( ) const
```

return true if all bits are set to 0

#### 10.218.4.21 operator=()

```
Overlay& gdcM::Overlay::operator= (
    Overlay const & ov )
```

#### 10.218.4.22 Print()

```
void gdcM::Overlay::Print (
    std::ostream & ) const [override], [virtual]
```

Print.

Reimplemented from [gdcM::Object](#).

#### 10.218.4.23 SetBitPosition()

```
void gdcM::Overlay::SetBitPosition (
    unsigned short bitposition )
```

set bit position

#### 10.218.4.24 SetBitsAllocated()

```
void gdcM::Overlay::SetBitsAllocated (
    unsigned short bitsallocated )
```

set bits allocated

#### 10.218.4.25 SetColumns()

```
void gdcM::Overlay::SetColumns (
    unsigned short columns )
```

set columns

#### 10.218.4.26 SetDescription()

```
void gdcm::Overlay::SetDescription (
    const char * description )
```

set description

#### 10.218.4.27 SetFrameOrigin()

```
void gdcm::Overlay::SetFrameOrigin (
    unsigned short frameorigin )
```

set frame origin

#### 10.218.4.28 SetGroup()

```
void gdcm::Overlay::SetGroup (
    unsigned short group )
```

Set Group number.

#### 10.218.4.29 SetNumberOfFrames()

```
void gdcm::Overlay::SetNumberOfFrames (
    unsigned int numberofframes )
```

set number of frames

#### 10.218.4.30 SetOrigin()

```
void gdcm::Overlay::SetOrigin (
    const signed short origin[2] )
```

set origin

#### 10.218.4.31 SetOverlay()

```
void gdcM::Overlay::SetOverlay (
    const char * array,
    size_t length )
```

set overlay from byte array + length

#### 10.218.4.32 SetRows()

```
void gdcM::Overlay::SetRows (
    unsigned short rows )
```

set rows

#### 10.218.4.33 SetType()

```
void gdcM::Overlay::SetType (
    const char * type )
```

set type

#### 10.218.4.34 Update()

```
void gdcM::Overlay::Update (
    const DataElement & de )
```

Update overlay from data element de:

The documentation for this class was generated from the following file:

- [gdcMOverlay.h](#)

## 10.219 gdcm::ParseException Class Reference

[ParseException](#) Standard exception handling object.

```
#include <gdcmParseException.h>
```

Inheritance diagram for gdcm::ParseException:

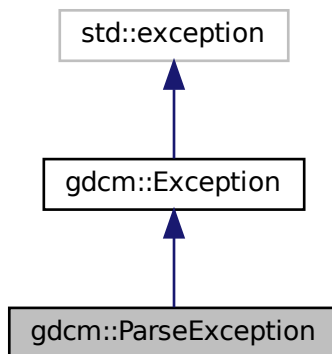

Collaboration diagram for gdcm::ParseException:

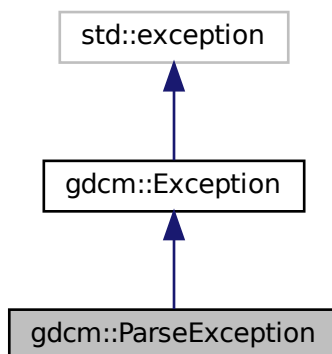

## Public Member Functions

- [ParseException](#) ()=default
- [ParseException](#) (const [ParseException](#) &orig)
- [~ParseException](#) () override throw ()
- const [DataElement](#) & [GetLastElement](#) () const
- [ParseException](#) & [operator=](#) (const [ParseException](#) &orig)
- void [SetLastElement](#) ([DataElement](#) &de)

### 10.219.1 Detailed Description

[ParseException](#) Standard exception handling object.

### 10.219.2 Constructor & Destructor Documentation

#### 10.219.2.1 [ParseException\(\)](#) [1/2]

```
gdcM::ParseException::ParseException ( ) [default]
```

#### 10.219.2.2 [~ParseException\(\)](#)

```
gdcM::ParseException::~~ParseException ( ) throw ( ) [inline], [override]
```

#### 10.219.2.3 [ParseException\(\)](#) [2/2]

```
gdcM::ParseException::ParseException (
    const ParseException & orig ) [inline]
```

### 10.219.3 Member Function Documentation

#### 10.219.3.1 [GetLastElement\(\)](#)

```
const DataElement& gdcM::ParseException::GetLastElement ( ) const [inline]
```

### 10.219.3.2 operator=()

```
ParseException& gdcm::ParseException::operator= (
    const ParseException & orig ) [inline]
```

Assignment operator.

### 10.219.3.3 SetLastElement()

```
void gdcm::ParseException::SetLastElement (
    DataElement & de ) [inline]
```

Equivalence operator.

Referenced by `gdcm::BasicOffsetTable::Read()`, `gdcm::Fragment::ReadBacktrack()`, and `gdcm::Fragment::ReadValue()`.

The documentation for this class was generated from the following file:

- [gdcmParseException.h](#)

## 10.220 gdcm::Parser Class Reference

[Parser](#) ala XML\_Parser from expat (SAX)

```
#include <gdcmParser.h>
```

### Public Types

- typedef void(\* [EndElementHandler](#)) (void \*userData, const [Tag](#) &name)
- enum [ErrorType](#) {  
    [NoError](#) ,  
    [NoMemoryError](#) ,  
    [SyntaxError](#) ,  
    [NoElementsError](#) ,  
    [TagMismatchError](#) ,  
    [DuplicateAttributeError](#) ,  
    [JunkAfterDocElementError](#) ,  
    [UndefinedEntityError](#) ,  
    [UnexpectedStateError](#) }
- typedef void(\* [StartElementHandler](#)) (void \*userData, const [Tag](#) &tag, const char \*atts[])

## Public Member Functions

- [Parser](#) ()
- [~Parser](#) ()
- unsigned long [GetCurrentByteIndex](#) () const
- [ErrorType](#) [GetErrorCode](#) () const
- void \* [GetUserData](#) () const
- bool [Parse](#) (const char \*s, int len, bool isFinal)
- void [SetElementHandler](#) ([StartElementHandler](#) start, [EndElementHandler](#) end)
- void [SetUserData](#) (void \*userData)

## Static Public Member Functions

- static const char \* [GetErrorString](#) ([ErrorType](#) const &err)

## Protected Member Functions

- char \* [GetBuffer](#) (int len)
- bool [ParseBuffer](#) (int len, bool isFinal)
- [ErrorType](#) [Process](#) ()

### 10.220.1 Detailed Description

[Parser](#) ala XML\_Parser from expat (SAX)

Detailed description here

#### Note

Simple API for DICOM

### 10.220.2 Member Typedef Documentation

#### 10.220.2.1 EndElementHandler

```
typedef void(* gdcM::Parser::EndElementHandler) (void *userData, const Tag &name)
```

#### 10.220.2.2 StartElementHandler

```
typedef void(* gdcM::Parser::StartElementHandler) (void *userData, const Tag &tag, const char *atts[])
```



## 10.220.3 Member Enumeration Documentation

### 10.220.3.1 ErrorType

enum `gdcm::Parser::ErrorType`

## Enumerator

NoError	
NoMemoryError	
SyntaxError	
NoElementsError	
TagMismatchError	
DuplicateAttributeError	
JunkAfterDocElementError	
UndefinedEntityError	
UnexpectedStateError	

## 10.220.4 Constructor & Destructor Documentation

### 10.220.4.1 Parser()

```
gdcM::Parser::Parser ( ) [inline]
```

### 10.220.4.2 ~Parser()

```
gdcM::Parser::~~Parser ( ) [inline]
```

## 10.220.5 Member Function Documentation

### 10.220.5.1 GetBuffer()

```
char* gdcM::Parser::GetBuffer (
    int len ) [protected]
```

### 10.220.5.2 GetCurrentByteIndex()

```
unsigned long gdcM::Parser::GetCurrentByteIndex ( ) const
```

### 10.220.5.3 GetErrorCode()

```
ErrorType gdcm::Parser::GetErrorCode ( ) const
```

### 10.220.5.4 GetErrorString()

```
static const char* gdcm::Parser::GetErrorString (
    ErrorType const & err ) [static]
```

### 10.220.5.5 GetUserData()

```
void* gdcm::Parser::GetUserData ( ) const
```

### 10.220.5.6 Parse()

```
bool gdcm::Parser::Parse (
    const char * s,
    int len,
    bool isFinal )
```

### 10.220.5.7 ParseBuffer()

```
bool gdcm::Parser::ParseBuffer (
    int len,
    bool isFinal ) [protected]
```

### 10.220.5.8 Process()

```
ErrorType gdcm::Parser::Process ( ) [protected]
```

### 10.220.5.9 SetElementHandler()

```
void gdcM::Parser::SetElementHandler (
    StartElementHandler start,
    EndElementHandler end )
```

### 10.220.5.10 SetUserData()

```
void gdcM::Parser::SetUserData (
    void * userData )
```

The documentation for this class was generated from the following file:

- [gdcMParser.h](#)

## 10.221 gdcM::Patient Class Reference

See PS 3.3 - 2007 DICOM MODEL OF THE REAL-WORLD, p 54.

```
#include <gdcMPatient.h>
```

### Public Member Functions

- [Patient](#) ()=default

#### 10.221.1 Detailed Description

See PS 3.3 - 2007 DICOM MODEL OF THE REAL-WORLD, p 54.

#### 10.221.2 Constructor & Destructor Documentation

##### 10.221.2.1 Patient()

```
gdcM::Patient::Patient ( ) [default]
```

The documentation for this class was generated from the following file:

- [gdcMPatient.h](#)

## 10.222 gdcm::network::PDataTFPDU Class Reference

[PDataTFPDU](#).

```
#include <gdcmPDataTFPDU.h>
```

Inheritance diagram for gdcm::network::PDataTFPDU:

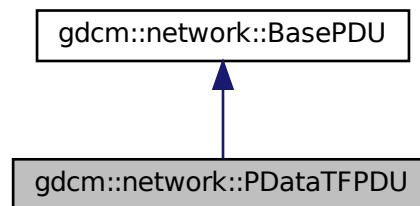

Collaboration diagram for gdcm::network::PDataTFPDU:

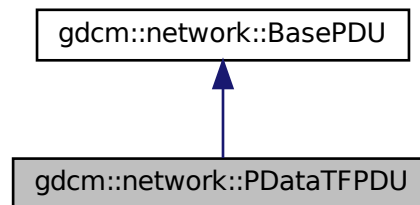

### Public Types

- typedef std::vector< [PresentationDataValue](#) >::size\_type [SizeType](#)

### Public Member Functions

- [PDataTFPDU](#) ()
- void [AddPresentationDataValue](#) ([PresentationDataValue](#) const &pdv)
- [SizeType](#) [GetNumberOfPresentationDataValues](#) () const
- [PresentationDataValue](#) const & [GetPresentationDataValue](#) ([SizeType](#) i) const
- bool [IsLastFragment](#) () const override
- void [Print](#) (std::ostream &os) const override
- std::istream & [Read](#) (std::istream &is) override
- size\_t [Size](#) () const override
- const std::ostream & [Write](#) (std::ostream &os) const override

## Protected Member Functions

- `std::istream & ReadInfo (std::istream &is, std::ostream &os)`

### 10.222.1 Detailed Description

[PDataTFPDU](#).

[Table 9-22 P-DATA-TF PDU FIELDS](#)

### 10.222.2 Member Typedef Documentation

#### 10.222.2.1 SizeType

```
typedef std::vector<PresentationDataValue>::size_type gdcn::network::PDataTFPDU::SizeType
```

### 10.222.3 Constructor & Destructor Documentation

#### 10.222.3.1 PDataTFPDU()

```
gdcn::network::PDataTFPDU::PDataTFPDU ( )
```

### 10.222.4 Member Function Documentation

#### 10.222.4.1 AddPresentationDataValue()

```
void gdcn::network::PDataTFPDU::AddPresentationDataValue (
    PresentationDataValue const & pdv ) [inline]
```

#### 10.222.4.2 GetNumberOfPresentationDataValues()

```
SizeType gdcn::network::PDataTFPDU::GetNumberOfPresentationDataValues ( ) const [inline]
```

#### 10.222.4.3 GetPresentationDataValue()

```
PresentationDataValue const& gdcn::network::PDataTFPDU::GetPresentationDataValue (
    SizeType i ) const [inline]
```

#### 10.222.4.4 IsLastFragment()

```
bool gdcn::network::PDataTFPDU::IsLastFragment ( ) const [override], [virtual]
```

Implements [gdcn::network::BasePDU](#).

#### 10.222.4.5 Print()

```
void gdcn::network::PDataTFPDU::Print (
    std::ostream & os ) const [override], [virtual]
```

Implements [gdcn::network::BasePDU](#).

#### 10.222.4.6 Read()

```
std::istream& gdcn::network::PDataTFPDU::Read (
    std::istream & is ) [override], [virtual]
```

Implements [gdcn::network::BasePDU](#).

#### 10.222.4.7 ReadInto()

```
std::istream& gdcn::network::PDataTFPDU::ReadInto (
    std::istream & is,
    std::ostream & os ) [protected]
```

#### 10.222.4.8 Size()

```
size_t gdcn::network::PDataTFPDU::Size ( ) const [override], [virtual]
```

Implements [gdcn::network::BasePDU](#).

#### 10.222.4.9 Write()

```
const std::ostream& gdcn::network::PDataTFPDU::Write (
    std::ostream & os ) const [override], [virtual]
```

Implements [gdcn::network::BasePDU](#).

The documentation for this class was generated from the following file:

- [gdcnPDataTFPDU.h](#)

## 10.223 gdcn::PDBelement Class Reference

Class to represent a PDB [Element](#).

```
#include <gdcnPDBElement.h>
```

Collaboration diagram for gdcn::PDBelement:

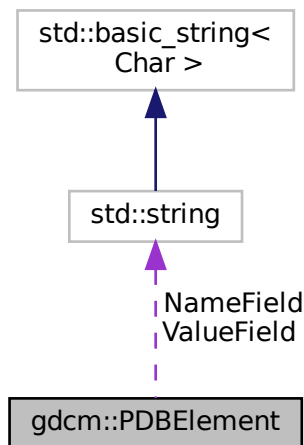



## Public Member Functions

- [PDBelement](#) ()=default
- const char \* [GetName](#) () const  
*Set/Get Name.*
- const char \* [GetValue](#) () const  
*Set/Get Value.*
- bool [operator==](#) (const [PDBelement](#) &de) const
- void [SetName](#) (const char \*name)
- void [SetValue](#) (const char \*value)

## Protected Attributes

- std::string [NameField](#)
- std::string [ValueField](#)

## Friends

- std::ostream & [operator<<](#) (std::ostream &os, const [PDBelement](#) &val)

### 10.223.1 Detailed Description

Class to represent a PDB [Element](#).

See also

[PDBHeader](#)

### 10.223.2 Constructor & Destructor Documentation

#### 10.223.2.1 PDBelement()

```
gdcmm::PDBelement::PDBelement ( ) [default]
```

### 10.223.3 Member Function Documentation

### 10.223.3.1 GetName()

```
const char* gdcm::PDBElement::GetName ( ) const [inline]
```

Set/Get Name.

### 10.223.3.2 GetValue()

```
const char* gdcm::PDBElement::GetValue ( ) const [inline]
```

Set/Get [Value](#).

### 10.223.3.3 operator==( )

```
bool gdcm::PDBElement::operator== (
    const PDBElement & de ) const [inline]
```

References NameField, and ValueField.

### 10.223.3.4 SetName()

```
void gdcm::PDBElement::SetName (
    const char * name ) [inline]
```

### 10.223.3.5 SetValue()

```
void gdcm::PDBElement::SetValue (
    const char * value ) [inline]
```

## 10.223.4 Friends And Related Function Documentation

### 10.223.4.1 operator<<

```
std::ostream& operator<< (
    std::ostream & os,
    const PDBElement & val ) [friend]
```

## 10.223.5 Member Data Documentation

### 10.223.5.1 NameField

```
std::string gdcM::PDBElement::NameField [protected]
```

Referenced by operator==().

### 10.223.5.2 ValueField

```
std::string gdcM::PDBElement::ValueField [protected]
```

Referenced by operator==().

The documentation for this class was generated from the following file:

- [gdcMPDBElement.h](#)

## 10.224 gdcM::PDBHeader Class Reference

Class for [PDBHeader](#).

```
#include <gdcMPDBHeader.h>
```

### Public Member Functions

- [PDBHeader](#) ()=default
- [~PDBHeader](#) ()=default
- bool [FindPDBElementByName](#) (const char \*name)  
*Return true if the PDB element matching name is found or not.*
- const [PDBElement](#) & [GetPDBElementByName](#) (const char \*name)
- bool [LoadFromDataElement](#) ([DataElement](#) const &de)  
*Load the PDB Header from a [DataElement](#) of a [DataSet](#).*
- void [Print](#) (std::ostream &os) const  
*Print.*

## Static Public Member Functions

- static const [PrivateTag](#) & [GetPDBInfoTag](#) ()  
*Return the Private Tag where the PDB header is stored within a DICOM [DataSet](#).*

## Protected Member Functions

- const [PDBElement](#) & [GetPDBEEnd](#) () const

## Friends

- `std::ostream & operator<<` (`std::ostream &_os`, const [PDBHeader](#) &d)

### 10.224.1 Detailed Description

Class for [PDBHeader](#).

GEMS MR [Image](#) have an [Attribute](#) (0025,1b,GEMS\_SERS\_01) which store the Acquisition parameter of the MR [Image](#). It is compressed and can therefore not be used as is. This class de-encapsulated the Protocol Data Block and allow users to query element by name.

#### Warning

Everything you do with this code is at your own risk, since decoding process was not written from specification documents.

: the API of this class might change.

#### See also

[CSAHeader](#)

### 10.224.2 Constructor & Destructor Documentation

#### 10.224.2.1 PDBHeader()

```
gdcm::PDBHeader::PDBHeader ( ) [default]
```

#### 10.224.2.2 ~PDBHeader()

```
gdcm::PDBHeader::~~PDBHeader ( ) [default]
```

## 10.224.3 Member Function Documentation

### 10.224.3.1 FindPDBElementByName()

```
bool gdcM::PDBHeader::FindPDBElementByName (
    const char * name )
```

Return true if the PDB element matching name is found or not.

### 10.224.3.2 GetPDBEEnd()

```
const PDBElement& gdcM::PDBHeader::GetPDBEEnd ( ) const [protected]
```

### 10.224.3.3 GetPDBElementByName()

```
const PDBElement& gdcM::PDBHeader::GetPDBElementByName (
    const char * name )
```

Lookup in the PDB header if a PDB element match the name 'name':

#### Warning

Case Sensitive

### 10.224.3.4 GetPDBInfoTag()

```
static const PrivateTag& gdcM::PDBHeader::GetPDBInfoTag ( ) [static]
```

Return the Private [Tag](#) where the PDB header is stored within a DICOM [DataSet](#).

### 10.224.3.5 LoadFromDataElement()

```
bool gdcM::PDBHeader::LoadFromDataElement (
    DataElement const & de )
```

Load the PDB Header from a [DataElement](#) of a [DataSet](#).

### 10.224.3.6 Print()

```
void gdcM::PDBHeader::Print (
    std::ostream & os ) const
```

Print.

## 10.224.4 Friends And Related Function Documentation

### 10.224.4.1 operator<<

```
std::ostream& operator<< (
    std::ostream & _os,
    const PDBHeader & d ) [friend]
```

The documentation for this class was generated from the following file:

- [gdcM\\_PDBHeader.h](#)

## 10.225 gdcM::PDFCodec Class Reference

[PDFCodec](#) class.

```
#include <gdcM_PDFCodec.h>
```

Inheritance diagram for gdcm::PDFCodec:

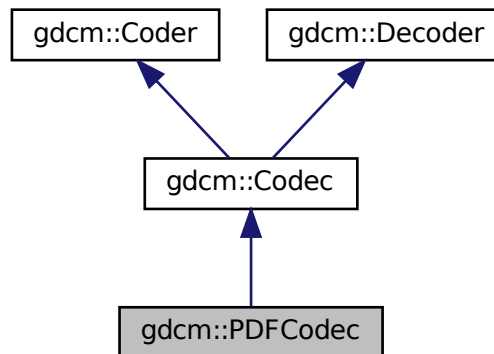

Collaboration diagram for gdcm::PDFCodec:

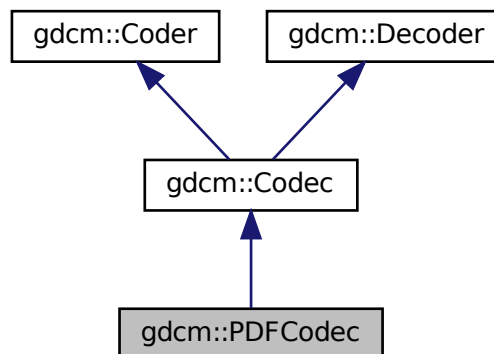

## Public Member Functions

- [PDFCodec](#) ()
- [~PDFCodec](#) () override
- bool [CanCode](#) ([TransferSyntax](#) const &) const override  
*Return whether this coder support this transfer syntax (can code it)*
- bool [CanDecode](#) ([TransferSyntax](#) const &) const override  
*Return whether this decoder support this transfer syntax (can decode it)*
- bool [Decode](#) ([DataElement](#) const &is, [DataElement](#) &os) override  
*Decode.*

## Additional Inherited Members

### 10.225.1 Detailed Description

[PDFCodec](#) class.

### 10.225.2 Constructor & Destructor Documentation

#### 10.225.2.1 PDFCodec()

```
gdcM::PDFCodec::PDFCodec ( )
```

#### 10.225.2.2 ~PDFCodec()

```
gdcM::PDFCodec::~~PDFCodec ( ) [override]
```

### 10.225.3 Member Function Documentation

#### 10.225.3.1 CanCode()

```
bool gdcM::PDFCodec::CanCode (
    TransferSyntax const & ) const [inline], [override], [virtual]
```

Return whether this coder support this transfer syntax (can code it)

Implements [gdcM::Coder](#).

#### 10.225.3.2 CanDecode()

```
bool gdcM::PDFCodec::CanDecode (
    TransferSyntax const & ) const [inline], [override], [virtual]
```

Return whether this decoder support this transfer syntax (can decode it)

Implements [gdcM::Decoder](#).



### 10.225.3.3 Decode()

```
bool gdcm::PDFCodec::Decode (
    DataElement const & ,
    DataElement & ) [override], [virtual]
```

Decode.

Reimplemented from [gdcm::Decoder](#).

The documentation for this class was generated from the following file:

- [gdcmPDFCodec.h](#)

## 10.226 gdcm::network::PDUFactory Class Reference

[PDUFactory](#) basically, given an initial byte, construct the.

```
#include <gdcmPDUFactory.h>
```

### Static Public Member Functions

- static [BasePDU](#) \* [ConstructAbortPDU](#) ()
- static [BasePDU](#) \* [ConstructPDU](#) (uint8\_t itemType)
- static [BasePDU](#) \* [ConstructReleasePDU](#) ()
- static std::vector< [BasePDU](#) \* > [CreateCEchoPDU](#) (const [ULConnection](#) &inConnection)
- static std::vector< [BasePDU](#) \* > [CreateCFindPDU](#) (const [ULConnection](#) &inConnection, const [BaseRootQuery](#) \*inRootQuery)
- static std::vector< [BasePDU](#) \* > [CreateCMovePDU](#) (const [ULConnection](#) &inConnection, const [BaseRootQuery](#) \*inRootQuery)
- static std::vector< [BasePDU](#) \* > [CreateCStoreRQPDU](#) (const [ULConnection](#) &inConnection, const [File](#) &file, bool writeDataSet=true)
- static std::vector< [BasePDU](#) \* > [CreateCStoreRSPDU](#) (const [DataSet](#) \*inDataSet, const [BasePDU](#) \*inPC)
- static std::vector< [BasePDU](#) \* > [CreateNActionPDU](#) (const [ULConnection](#) &inConnection, const [BaseQuery](#) \*inQuery)
- static std::vector< [BasePDU](#) \* > [CreateNCreatePDU](#) (const [ULConnection](#) &inConnection, const [BaseQuery](#) \*inQuery)
- static std::vector< [BasePDU](#) \* > [CreateNDeletePDU](#) (const [ULConnection](#) &inConnection, const [BaseQuery](#) \*inQuery)
- static std::vector< [BasePDU](#) \* > [CreateNEventReportPDU](#) (const [ULConnection](#) &inConnection, const [BaseQuery](#) \*inQuery)
- static std::vector< [BasePDU](#) \* > [CreateNGetPDU](#) (const [ULConnection](#) &inConnection, const [BaseQuery](#) \*inQuery)
- static std::vector< [BasePDU](#) \* > [CreateNSetPDU](#) (const [ULConnection](#) &inConnection, const [BaseQuery](#) \*inQuery)
- static [EEventID](#) [DetermineEventByPDU](#) (const [BasePDU](#) \*inPDU)
- static std::vector< [PresentationDataValue](#) > [GetPDVs](#) (const std::vector< [BasePDU](#) \* > &inDataPDUs)

## 10.226.1 Detailed Description

[PDUFactory](#) basically, given an initial byte, construct the

appropriate PDU. This way, the event loop doesn't have to know about all the different PDU types.

## 10.226.2 Member Function Documentation

### 10.226.2.1 ConstructAbortPDU()

```
static BasePDU* gdcn::network::PDUFactory::ConstructAbortPDU ( ) [static]
```

### 10.226.2.2 ConstructPDU()

```
static BasePDU* gdcn::network::PDUFactory::ConstructPDU (
    uint8_t itemtype ) [static]
```

### 10.226.2.3 ConstructReleasePDU()

```
static BasePDU* gdcn::network::PDUFactory::ConstructReleasePDU ( ) [static]
```

### 10.226.2.4 CreateCEchoPDU()

```
static std::vector<BasePDU*> gdcn::network::PDUFactory::CreateCEchoPDU (
    const ULConnection & inConnection ) [static]
```

### 10.226.2.5 CreateCFindPDU()

```
static std::vector<BasePDU*> gdcn::network::PDUFactory::CreateCFindPDU (
    const ULConnection & inConnection,
    const BaseRootQuery * inRootQuery ) [static]
```

### 10.226.2.6 CreateCMovePDU()

```
static std::vector<BasePDU*> gdcmm::network::PDUFactory::CreateCMovePDU (
    const ULConnection & inConnection,
    const BaseRootQuery * inRootQuery ) [static]
```

### 10.226.2.7 CreateCStoreRQPDU()

```
static std::vector<BasePDU*> gdcmm::network::PDUFactory::CreateCStoreRQPDU (
    const ULConnection & inConnection,
    const File & file,
    bool writeDataSet = true ) [static]
```

### 10.226.2.8 CreateCStoreRSPDU()

```
static std::vector<BasePDU*> gdcmm::network::PDUFactory::CreateCStoreRSPDU (
    const DataSet * inDataSet,
    const BasePDU * inPC ) [static]
```

### 10.226.2.9 CreateNActionPDU()

```
static std::vector<BasePDU*> gdcmm::network::PDUFactory::CreateNActionPDU (
    const ULConnection & inConnection,
    const BaseQuery * inQuery ) [static]
```

### 10.226.2.10 CreateNCreatePDU()

```
static std::vector<BasePDU*> gdcmm::network::PDUFactory::CreateNCreatePDU (
    const ULConnection & inConnection,
    const BaseQuery * inQuery ) [static]
```

### 10.226.2.11 CreateNDeletePDU()

```
static std::vector<BasePDU*> gdcmm::network::PDUFactory::CreateNDeletePDU (
    const ULConnection & inConnection,
    const BaseQuery * inQuery ) [static]
```

### 10.226.2.12 CreateNEventReportPDU()

```
static std::vector<BasePDU*> gdc::network::PDUFactory::CreateNEventReportPDU (
    const ULConnection & inConnection,
    const BaseQuery * inQuery ) [static]
```

### 10.226.2.13 CreateNGetPDU()

```
static std::vector<BasePDU*> gdc::network::PDUFactory::CreateNGetPDU (
    const ULConnection & inConnection,
    const BaseQuery * inQuery ) [static]
```

### 10.226.2.14 CreateNSetPDU()

```
static std::vector<BasePDU*> gdc::network::PDUFactory::CreateNSetPDU (
    const ULConnection & inConnection,
    const BaseQuery * inQuery ) [static]
```

### 10.226.2.15 DetermineEventByPDU()

```
static EEventID gdc::network::PDUFactory::DetermineEventByPDU (
    const BasePDU * inPDU ) [static]
```

### 10.226.2.16 GetPDVs()

```
static std::vector<PresentationDataValue> gdc::network::PDUFactory::GetPDVs (
    const std::vector< BasePDU * > & inDataPDUs ) [static]
```

The documentation for this class was generated from the following file:

- [gdcPDUFactory.h](#)

## 10.227 gdc::PersonName Class Reference

[PersonName](#) class.

```
#include <gdcPersonName.h>
```

## Public Member Functions

- unsigned int [GetMaxLength](#) () const
- unsigned int [GetNumberOfComponents](#) () const
- void [Print](#) (std::ostream &os) const
- void [SetBlob](#) (const std::vector< char > &v)
- void [SetComponents](#) (const char \*comp1="", const char \*comp2="", const char \*comp3="", const char \*comp4="", const char \*comp5="")
- void [SetComponents](#) (const char \*components[ ])

## Public Attributes

- char [Component](#) [[MaxNumberOfComponents](#)][[MaxLength](#)+1]

## Static Public Attributes

- static const unsigned int [MaxLength](#) = 64
- static const unsigned int [MaxNumberOfComponents](#) = 5
- static const char [Padding](#) = ' '
- static const char [Separator](#) = '^'

### 10.227.1 Detailed Description

[PersonName](#) class.

### 10.227.2 Member Function Documentation

#### 10.227.2.1 GetMaxLength()

```
unsigned int gdcM::PersonName::GetMaxLength ( ) const [inline]
```

#### 10.227.2.2 GetNumberOfComponents()

```
unsigned int gdcM::PersonName::GetNumberOfComponents ( ) const [inline]
```

### 10.227.2.3 Print()

```
void gdcM::PersonName::Print (
    std::ostream & os ) const [inline]
```

### 10.227.2.4 SetBlob()

```
void gdcM::PersonName::SetBlob (
    const std::vector< char > & v ) [inline]
```

### 10.227.2.5 SetComponents() [1/2]

```
void gdcM::PersonName::SetComponents (
    const char * comp1 = "",
    const char * comp2 = "",
    const char * comp3 = "",
    const char * comp4 = "",
    const char * comp5 = "" ) [inline]
```

### 10.227.2.6 SetComponents() [2/2]

```
void gdcM::PersonName::SetComponents (
    const char * components[] ) [inline]
```

## 10.227.3 Member Data Documentation

### 10.227.3.1 Component

```
char gdcM::PersonName::Component [MaxNumberOfComponents] [MaxLength+1]
```

### 10.227.3.2 MaxLength

```
const unsigned int gdcM::PersonName::MaxLength = 64 [static]
```

### 10.227.3.3 MaxNumberOfComponents

```
const unsigned int gdcm::PersonName::MaxNumberOfComponents = 5 [static]
```

### 10.227.3.4 Padding

```
const char gdcm::PersonName::Padding = ' ' [static]
```

### 10.227.3.5 Separator

```
const char gdcm::PersonName::Separator = '^' [static]
```

The documentation for this class was generated from the following file:

- [gdcmPersonName.h](#)

## 10.228 gdcm::PGXCodec Class Reference

Class to do PGX.

```
#include <gdcmPGXCodec.h>
```

Inheritance diagram for gdcm::PGXCodec:

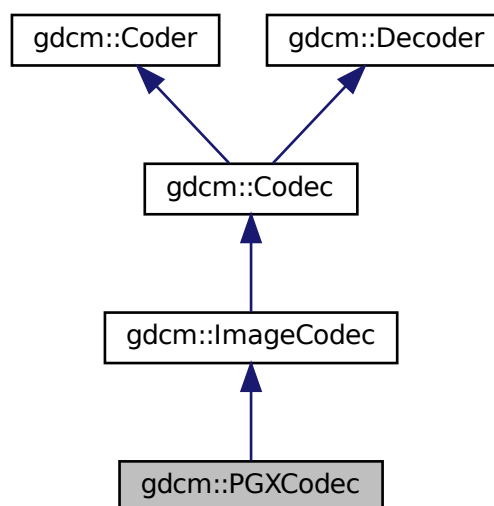

Collaboration diagram for `gdcm::PGXCodec`:

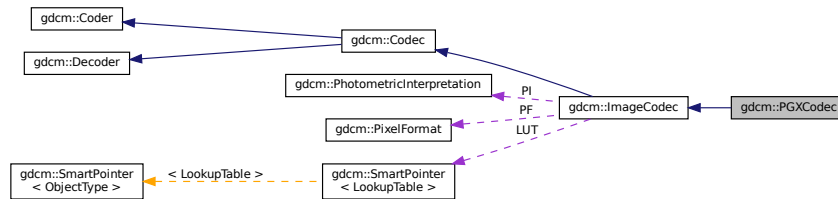

## Public Member Functions

- [PGXCodec](#) ()
- [~PGXCodec](#) () override
- bool [CanCode](#) ([TransferSyntax](#) const &ts) const override  
*Return whether this coder support this transfer syntax (can code it)*
- bool [CanDecode](#) ([TransferSyntax](#) const &ts) const override  
*Return whether this decoder support this transfer syntax (can decode it)*
- [ImageCodec](#) \* [Clone](#) () const override
- bool [GetHeaderInfo](#) (std::istream &is, [TransferSyntax](#) &ts) override
- bool [Read](#) (const char \*filename, [DataElement](#) &out) const
- bool [Write](#) (const char \*filename, const [DataElement](#) &out) const

## Additional Inherited Members

### 10.228.1 Detailed Description

Class to do PGX.

See PGX as used in JPEG 2000 implementation and reference images

### 10.228.2 Constructor & Destructor Documentation

#### 10.228.2.1 PGXCodec()

```
gdcm::PGXCodec::PGXCodec ( )
```



### 10.228.2.2 ~PGXCodec()

```
gdcm::PGXCodec::~~PGXCodec ( ) [override]
```

## 10.228.3 Member Function Documentation

### 10.228.3.1 CanCode()

```
bool gdcm::PGXCodec::CanCode (
    TransferSyntax const & ) const [override], [virtual]
```

Return whether this coder support this transfer syntax (can code it)

Reimplemented from [gdcm::ImageCodec](#).

### 10.228.3.2 CanDecode()

```
bool gdcm::PGXCodec::CanDecode (
    TransferSyntax const & ) const [override], [virtual]
```

Return whether this decoder support this transfer syntax (can decode it)

Reimplemented from [gdcm::ImageCodec](#).

### 10.228.3.3 Clone()

```
ImageCodec* gdcm::PGXCodec::Clone ( ) const [override], [virtual]
```

Implements [gdcm::ImageCodec](#).

### 10.228.3.4 GetHeaderInfo()

```
bool gdcm::PGXCodec::GetHeaderInfo (
    std::istream & is,
    TransferSyntax & ts ) [override], [virtual]
```

Reimplemented from [gdcm::ImageCodec](#).

### 10.228.3.5 Read()

```
bool gdcM::PGXCodec::Read (
    const char * filename,
    DataElement & out ) const
```

### 10.228.3.6 Write()

```
bool gdcM::PGXCodec::Write (
    const char * filename,
    const DataElement & out ) const
```

The documentation for this class was generated from the following file:

- [gdcMPGXCodec.h](#)

## 10.229 gdcM::PhotometricInterpretation Class Reference

Class to represent an [PhotometricInterpretation](#).

```
#include <gdcMPhotometricInterpretation.h>
```

### Public Types

- enum [PType](#) {  
    UNKNOWN = 0 ,  
    MONOCHROME1 ,  
    MONOCHROME2 ,  
    PALETTE\_COLOR ,  
    RGB ,  
    HSV ,  
    ARGB ,  
    CMYK ,  
    YBR\_FULL ,  
    YBR\_FULL\_422 ,  
    YBR\_PARTIAL\_422 ,  
    YBR\_PARTIAL\_420 ,  
    YBR\_ICT ,  
    YBR\_RCT ,  
    PI\_END }

## Public Member Functions

- [PhotometricInterpretation](#) ([PIType](#) pi=[UNKNOWN](#))
- unsigned short [GetSamplesPerPixel](#) () const  
*return the value for Sample Per Pixel associated with a particular Photometric Interpretation*
- const char \* [GetString](#) () const
- [PIType](#) [GetType](#) () const
- bool [IsLossless](#) () const
- bool [IsLossy](#) () const
- bool [IsSameColorSpace](#) ([PhotometricInterpretation](#) const &pi) const
- [operator PIType](#) () const

## Static Public Member Functions

- static const char \* [GetPIString](#) ([PIType](#) pi)
- static [PIType](#) [GetPIType](#) (const char \*pi)
- static bool [IsRetired](#) ([PIType](#) pi)

## Friends

- [std::ostream](#) & [operator<<](#) ([std::ostream](#) &os, const [PhotometricInterpretation](#) &pi)

### 10.229.1 Detailed Description

Class to represent an [PhotometricInterpretation](#).

#### Examples

[CreateARGBImage.cxx](#), [CreateCMYKImage.cxx](#), [HelloVizWorld.cxx](#), [csa2img.cxx](#), and [iU22tomultisc.cxx](#).

### 10.229.2 Member Enumeration Documentation

## Enumerator

---

### 10.229.2.1 PType

```
enum gdcM::PhotometricInterpretation::PType
```

#### Enumerator

UNKNOWN	
MONOCHROME1	
MONOCHROME2	
PALETTE_COLOR	
RGB	
HSV	
ARGB	
CMYK	
YBR_FULL	
YBR_FULL_422	
YBR_PARTIAL_422	
YBR_PARTIAL_420	
YBR_ICT	
YBR_RCT	
PI_END	

## 10.229.3 Constructor & Destructor Documentation

### 10.229.3.1 PhotometricInterpretation()

```
gdcM::PhotometricInterpretation::PhotometricInterpretation (
    PType pi = UNKNOWN ) [inline]
```

## 10.229.4 Member Function Documentation

### 10.229.4.1 GetPIString()

```
static const char* gdcM::PhotometricInterpretation::GetPIString (
    PType pi ) [static]
```

#### 10.229.4.2 GetPIType()

```
static PType gdcm::PhotometricInterpretation::GetPIType (
    const char * pi ) [static]
```

#### 10.229.4.3 GetSamplesPerPixel()

```
unsigned short gdcm::PhotometricInterpretation::GetSamplesPerPixel ( ) const
```

return the value for Sample Per Pixel associated with a particular Photometric Interpretation

#### 10.229.4.4 GetString()

```
const char* gdcm::PhotometricInterpretation::GetString ( ) const
```

#### 10.229.4.5 GetType()

```
PType gdcm::PhotometricInterpretation::GetType ( ) const [inline]
```

#### 10.229.4.6 IsLossless()

```
bool gdcm::PhotometricInterpretation::IsLossless ( ) const
```

#### 10.229.4.7 IsLossy()

```
bool gdcm::PhotometricInterpretation::IsLossy ( ) const
```

#### 10.229.4.8 IsRetired()

```
static bool gdcm::PhotometricInterpretation::IsRetired (
    PType pi ) [static]
```

#### 10.229.4.9 IsSameColorSpace()

```
bool gdcM::PhotometricInterpretation::IsSameColorSpace (
    PhotometricInterpretation const & pi ) const
```

#### 10.229.4.10 operator PType()

```
gdcM::PhotometricInterpretation::operator PType ( ) const [inline]
```

### 10.229.5 Friends And Related Function Documentation

#### 10.229.5.1 operator<<

```
std::ostream& operator<< (
    std::ostream & os,
    const PhotometricInterpretation & pi ) [friend]
```

The documentation for this class was generated from the following file:

- [gdcMPhotometricInterpretation.h](#)

## 10.230 gdcM::PixelFormat Class Reference

[PixelFormat](#).

```
#include <gdcMPixelFormat.h>
```

### Public Types

- enum [ScalarType](#) {  
    [UINT8](#) ,  
    [INT8](#) ,  
    [UINT12](#) ,  
    [INT12](#) ,  
    [UINT16](#) ,  
    [INT16](#) ,  
    [UINT32](#) ,  
    [INT32](#) ,  
    [UINT64](#) ,  
    [INT64](#) ,  
    [FLOAT16](#) ,  
    [FLOAT32](#) ,  
    [FLOAT64](#) ,  
    [SINGLEBIT](#) ,  
    [UNKNOWN](#) }

## Public Member Functions

- [PixelFormat](#) ()
- [PixelFormat](#) ([ScalarType](#) st)
- [PixelFormat](#) (unsigned short samplesperpixel, unsigned short bitsallocated=8, unsigned short bitsstored=8, unsigned short highbit=7, unsigned short pixelrepresentation=0)
- unsigned short [GetBitsAllocated](#) () const  
*BitsAllocated see [Tag](#) (0028,0100) US Bits Allocated.*
- unsigned short [GetBitsStored](#) () const  
*BitsStored see [Tag](#) (0028,0101) US Bits Stored.*
- unsigned short [GetHighBit](#) () const  
*HighBit see [Tag](#) (0028,0102) US High Bit.*
- int64\_t [GetMax](#) () const  
*return the max possible of the pixel*
- int64\_t [GetMin](#) () const  
*return the min possible of the pixel*
- unsigned short [GetPixelRepresentation](#) () const  
*PixelRepresentation: 0 or 1, see [Tag](#) (0028,0103) US Pixel Representation.*
- uint8\_t [GetPixelSize](#) () const
- unsigned short [GetSamplesPerPixel](#) () const
- [ScalarType](#) [GetScalarType](#) () const  
*ScalarType does not take into account the sample per pixel.*
- const char \* [GetScalarTypeAsString](#) () const
- bool [IsCompatible](#) (const [TransferSyntax](#) &ts) const
- bool [IsValid](#) () const  
*return IsValid*
- [operator ScalarType](#) () const
- bool [operator!=](#) (const [PixelFormat](#) &pf) const
- bool [operator!=](#) ([ScalarType](#) st) const
- bool [operator==](#) (const [PixelFormat](#) &pf) const
- bool [operator==](#) ([ScalarType](#) st) const
- void [Print](#) (std::ostream &os) const  
*Print.*
- void [SetBitsAllocated](#) (unsigned short ba)
- void [SetBitsStored](#) (unsigned short bs)
- void [SetHighBit](#) (unsigned short hb)
- void [SetPixelRepresentation](#) (unsigned short pr)
- void [SetSamplesPerPixel](#) (unsigned short spp)
- void [SetScalarType](#) ([ScalarType](#) st)

## Protected Member Functions

- bool [Validate](#) ()  
*When image with 24/24/23 was read, need to validate.*

## Friends

- class [Bitmap](#)
- std::ostream & [operator<<](#) (std::ostream &\_os, const [PixelFormat](#) &pf)

### 10.230.1 Detailed Description

#### [PixelFormat](#).

By default the Pixel [Type](#) will be instantiated with the following parameters:

- SamplesPerPixel : 1
- BitsAllocated : 8
- BitsStored : 8
- HighBit : 7
- PixelRepresentation : 0

Fundamentally [PixelFormat](#) is very close to what DICOM allows. It will be very hard to extend this class for the upcoming DICOM standard where Floating 32 and 64bits will be allowed.

It is also very hard for this class to fully support 64bits integer type (see GetMin / GetMax signature restricted to 64bits signed).

#### Examples

[CreateARGBImage.cxx](#), [CreateCMYKImage.cxx](#), [FixJAIBugJPEGLS.cxx](#), [GetJPEGSamplePrecision.cxx](#), [TemplateEmptyImage.cxx](#), [csa2img.cxx](#), [iU22tomultisc.cxx](#), and [threadgdcmm.cxx](#).

### 10.230.2 Member Enumeration Documentation

#### 10.230.2.1 ScalarType

```
enum gdcmm::PixelFormat::ScalarType
```

##### Enumerator

UINT8	
INT8	
UINT12	
INT12	
UINT16	
INT16	
UINT32	
INT32	
UINT64	
INT64	
FLOAT16	
FLOAT32	
FLOAT64	
SINGLEBIT	
UNKNOWN	



## 10.230.3 Constructor & Destructor Documentation

### 10.230.3.1 PixelFormat() [1/3]

```
gdcm::PixelFormat::PixelFormat ( ) [inline]
```

### 10.230.3.2 PixelFormat() [2/3]

```
gdcm::PixelFormat::PixelFormat (
    unsigned short samplesperpixel,
    unsigned short bitsallocated = 8,
    unsigned short bitsstored = 8,
    unsigned short highbit = 7,
    unsigned short pixelrepresentation = 0 ) [inline], [explicit]
```

### 10.230.3.3 PixelFormat() [3/3]

```
gdcm::PixelFormat::PixelFormat (
    ScalarType st )
```

## 10.230.4 Member Function Documentation

### 10.230.4.1 GetBitsAllocated()

```
unsigned short gdcm::PixelFormat::GetBitsAllocated ( ) const [inline]
```

BitsAllocated see [Tag](#) (0028,0100) US Bits Allocated.

#### Examples

[GetJPEGSamplePrecision.cxx](#).

#### 10.230.4.2 GetBitsStored()

```
unsigned short gdcm::PixelFormat::GetBitsStored ( ) const [inline]
```

BitsStored see [Tag \(0028,0101\)](#) US Bits Stored.

#### Examples

[GetJPEGSamplePrecision.cxx](#).

#### 10.230.4.3 GetHighBit()

```
unsigned short gdcm::PixelFormat::GetHighBit ( ) const [inline]
```

HighBit see [Tag \(0028,0102\)](#) US High Bit.

#### 10.230.4.4 GetMax()

```
int64_t gdcm::PixelFormat::GetMax ( ) const
```

return the max possible of the pixel

#### 10.230.4.5 GetMin()

```
int64_t gdcm::PixelFormat::GetMin ( ) const
```

return the min possible of the pixel

#### 10.230.4.6 GetPixelRepresentation()

```
unsigned short gdcm::PixelFormat::GetPixelRepresentation ( ) const [inline]
```

PixelRepresentation: 0 or 1, see [Tag \(0028,0103\)](#) US Pixel Representation.

#### 10.230.4.7 GetPixelSize()

```
uint8_t gdcm::PixelFormat::GetPixelSize ( ) const
```

return the size of the pixel This is the number of words it would take to store one pixel

##### Warning

the return value takes into account the SamplesPerPixel  
in the rare case when BitsAllocated == 12, the function assume word padding and value returned will be identical as if BitsAllocated == 16

##### Examples

[threadgdcm.cxx](#).

#### 10.230.4.8 GetSamplesPerPixel()

```
unsigned short gdcm::PixelFormat::GetSamplesPerPixel ( ) const
```

Samples Per Pixel see (0028,0002) US Samples Per Pixel DICOM - only allows 1, 3 and 4 as valid value. Other value are undefined behavior.

##### Examples

[threadgdcm.cxx](#).

#### 10.230.4.9 GetScalarType()

```
ScalarType gdcm::PixelFormat::GetScalarType ( ) const
```

ScalarType does not take into account the sample per pixel.

#### 10.230.4.10 GetScalarTypeAsString()

```
const char* gdcm::PixelFormat::GetScalarTypeAsString ( ) const
```

#### 10.230.4.11 IsCompatible()

```
bool gdcm::PixelFormat::IsCompatible (
    const TransferSyntax & ts ) const
```

#### 10.230.4.12 IsValid()

```
bool gdcm::PixelFormat::IsValid ( ) const
```

```
return IsValid
```

#### 10.230.4.13 operator ScalarType()

```
gdcm::PixelFormat::operator ScalarType ( ) const [inline]
```

#### 10.230.4.14 operator!=( ) [1/2]

```
bool gdcm::PixelFormat::operator!= (
    const PixelFormat & pf ) const [inline]
```

#### 10.230.4.15 operator!=( ) [2/2]

```
bool gdcm::PixelFormat::operator!= (
    ScalarType st ) const [inline]
```

#### 10.230.4.16 operator==( ) [1/2]

```
bool gdcm::PixelFormat::operator== (
    const PixelFormat & pf ) const [inline]
```

#### 10.230.4.17 operator==( ) [2/2]

```
bool gdcM::PixelFormat::operator==(
    ScalarType st ) const [inline]
```

#### 10.230.4.18 Print()

```
void gdcM::PixelFormat::Print (
    std::ostream & os ) const
```

Print.

#### 10.230.4.19 SetBitsAllocated()

```
void gdcM::PixelFormat::SetBitsAllocated (
    unsigned short ba ) [inline]
```

#### 10.230.4.20 SetBitsStored()

```
void gdcM::PixelFormat::SetBitsStored (
    unsigned short bs ) [inline]
```

#### 10.230.4.21 SetHighBit()

```
void gdcM::PixelFormat::SetHighBit (
    unsigned short hb ) [inline]
```

#### 10.230.4.22 SetPixelRepresentation()

```
void gdcM::PixelFormat::SetPixelRepresentation (
    unsigned short pr ) [inline]
```

#### Examples

[TemplateEmptyImage.cxx](#).

#### 10.230.4.23 SetSamplesPerPixel()

```
void gdcM::PixelFormat::SetSamplesPerPixel (
    unsigned short spp ) [inline]
```

##### Examples

[CreateARGBImage.cxx](#), [CreateCMYKImage.cxx](#), and [GenFakeImage.cxx](#).

References `gdcMAssertMacro`.

#### 10.230.4.24 SetScalarType()

```
void gdcM::PixelFormat::SetScalarType (
    ScalarType st )
```

Set `PixelFormat` based only on the `ScalarType`

##### Warning

: You need to call `SetScalarType` *before* `SetSamplesPerPixel`

#### 10.230.4.25 Validate()

```
bool gdcM::PixelFormat::Validate ( ) [protected]
```

When image with 24/24/23 was read, need to validate.

Referenced by `gdcM::Bitmap::SetPixelFormat()`.

### 10.230.5 Friends And Related Function Documentation

#### 10.230.5.1 Bitmap

```
friend class Bitmap [friend]
```

### 10.230.5.2 operator<<

```
std::ostream& operator<< (
    std::ostream & _os,
    const PixelFormat & pf ) [friend]
```

The documentation for this class was generated from the following file:

- [gdcmPixelFormat.h](#)

## 10.231 gdcm::Pixmap Class Reference

[Pixmap](#) class.

```
#include <gdcmPixmap.h>
```

Inheritance diagram for gdcm::Pixmap:

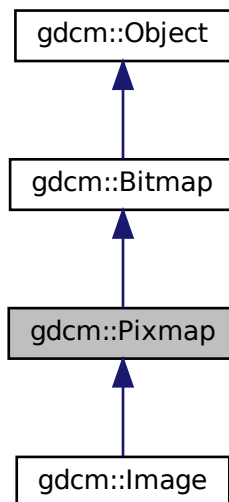

Collaboration diagram for `gdcm::Pixmap`:

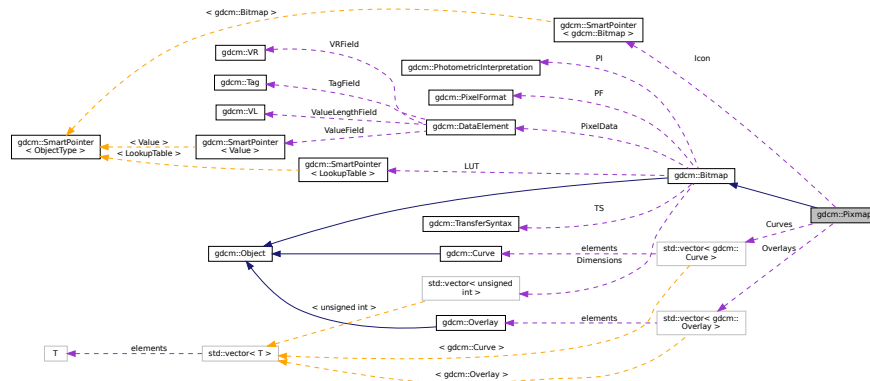

## Public Member Functions

- `Pixmap ()`
- `~Pixmap ()` override
- `bool AreOverlaysInPixelData ()` const override  
*returns if Overlays are stored in the unused bit of the pixel data:*
- `Curve & GetCurve (size_t i=0)`  
*Curve: group 50xx.*
- `const Curve & GetCurve (size_t i=0)` const
- `IconImage & GetIconImage ()`
- `const IconImage & GetIconImage ()` const  
*Set/Get Icon Image.*
- `size_t GetNumberOfCurves ()` const
- `size_t GetNumberOfOverlays ()` const
- `Overlay & GetOverlay (size_t i=0)`  
*Overlay: group 60xx.*
- `const Overlay & GetOverlay (size_t i=0)` const
- `void Print (std::ostream &)` const override
- `void RemoveOverlay (size_t i)`
- `void SetIconImage (IconImage const &i)`
- `void SetNumberOfCurves (size_t n)`
- `void SetNumberOfOverlays (size_t n)`
- `bool UnusedBitsPresentInPixelData ()` const override  
*returns if there are unused bits in the pixel data*

## Protected Attributes

- `std::vector< Curve > Curves`
- `SmartPointer< IconImage > Icon`
- `std::vector< Overlay > Overlays`



## Additional Inherited Members

### 10.231.1 Detailed Description

[Pixmap](#) class.

A bitmap based image. Used as parent for both IconImage and the main Pixel Data [Image](#) It does not contains any World Space information (IPP, IOP)

See also

[PixmapReader](#)

### 10.231.2 Constructor & Destructor Documentation

#### 10.231.2.1 Pixmap()

```
gdcm::Pixmap::Pixmap ( )
```

#### 10.231.2.2 ~Pixmap()

```
gdcm::Pixmap::~Pixmap ( ) [override]
```

### 10.231.3 Member Function Documentation

#### 10.231.3.1 AreOverlaysInPixelData()

```
bool gdcm::Pixmap::AreOverlaysInPixelData ( ) const [override], [virtual]
```

returns if Overlays are stored in the unused bit of the pixel data:

Reimplemented from [gdcm::Bitmap](#).

**10.231.3.2 GetCurve()** [1/2]

```
Curve& gdcm::Pixmap::GetCurve (
    size_t i = 0 ) [inline]
```

[Curve](#): group 50xx.

**10.231.3.3 GetCurve()** [2/2]

```
const Curve& gdcm::Pixmap::GetCurve (
    size_t i = 0 ) const [inline]
```

**10.231.3.4 GetIconImage()** [1/2]

```
IconImage& gdcm::Pixmap::GetIconImage ( ) [inline]
```

**10.231.3.5 GetIconImage()** [2/2]

```
const IconImage& gdcm::Pixmap::GetIconImage ( ) const [inline]
```

Set/Get Icon [Image](#).

**10.231.3.6 GetNumberOfCurves()**

```
size_t gdcm::Pixmap::GetNumberOfCurves ( ) const [inline]
```

**10.231.3.7 GetNumberOfOverlays()**

```
size_t gdcm::Pixmap::GetNumberOfOverlays ( ) const [inline]
```

### 10.231.3.8 GetOverlay() [1/2]

```
Overlay& gdcM::Pixmap::GetOverlay (
    size_t i = 0 ) [inline]
```

Overlay: group 60xx.

### 10.231.3.9 GetOverlay() [2/2]

```
const Overlay& gdcM::Pixmap::GetOverlay (
    size_t i = 0 ) const [inline]
```

### 10.231.3.10 Print()

```
void gdcM::Pixmap::Print (
    std::ostream & ) const [override], [virtual]
```

Reimplemented from [gdcM::Bitmap](#).

### 10.231.3.11 RemoveOverlay()

```
void gdcM::Pixmap::RemoveOverlay (
    size_t i ) [inline]
```

### 10.231.3.12 SetIconImage()

```
void gdcM::Pixmap::SetIconImage (
    IconImage const & ii ) [inline]
```

### 10.231.3.13 SetNumberOfCurves()

```
void gdcM::Pixmap::SetNumberOfCurves (
    size_t n ) [inline]
```

#### 10.231.3.14 SetNumberOfOverlays()

```
void gdcM::Pixmap::SetNumberOfOverlays (
    size_t n ) [inline]
```

#### 10.231.3.15 UnusedBitsPresentInPixelData()

```
bool gdcM::Pixmap::UnusedBitsPresentInPixelData ( ) const [override], [virtual]
```

returns if there are unused bits in the pixel data

Reimplemented from [gdcM::Bitmap](#).

### 10.231.4 Member Data Documentation

#### 10.231.4.1 Curves

```
std::vector<Curve> gdcM::Pixmap::Curves [protected]
```

#### 10.231.4.2 Icon

```
SmartPointer<IconImage> gdcM::Pixmap::Icon [protected]
```

#### 10.231.4.3 Overlays

```
std::vector<Overlay> gdcM::Pixmap::Overlays [protected]
```

The documentation for this class was generated from the following file:

- [gdcMPixmap.h](#)

## 10.232 gdcm::PixmapReader Class Reference

[PixmapReader](#).

```
#include <gdcmPixmapReader.h>
```

Inheritance diagram for gdcm::PixmapReader:

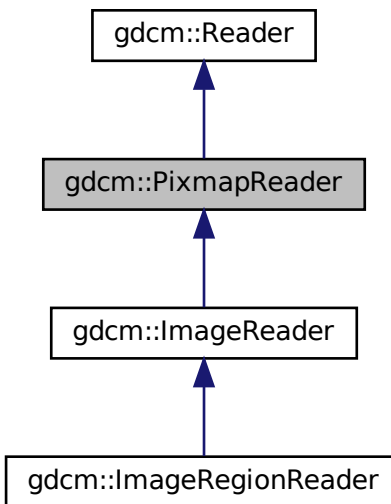

Collaboration diagram for `gdcm::PixmapReader`:

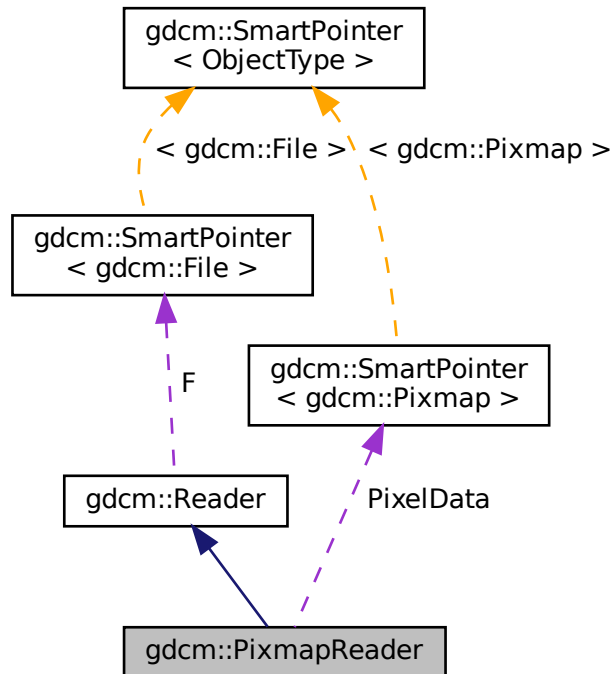

## Public Member Functions

- [PixmapReader](#) ()
- [~PixmapReader](#) () override
- [Pixmap](#) & [GetPixmap](#) ()
- const [Pixmap](#) & [GetPixmap](#) () const  
*Return the read image (need to call [Read\(\)](#) first)*
- bool [Read](#) () override

## Protected Member Functions

- virtual bool [ReadACRNEMAIImage](#) ()
- virtual bool [ReadImage](#) ([MediaStorage](#) const &ms)
- bool [ReadImageInternal](#) ([MediaStorage](#) const &ms, bool handlepixeldata=true)

## Protected Attributes

- [SmartPointer](#)< [Pixmap](#) > [PixelData](#)

## 10.232.1 Detailed Description

[PixmapReader](#).

### Note

its role is to convert the DICOM [DataSet](#) into a [Pixmap](#) representation By default it is also loading the lookup table and overlay when found as they impact the rendering of the image

See PS 3.3-2008, [Table C.7-11b IMAGE PIXEL MACRO ATTRIBUTES](#) for the list of attribute that belong to what gdcm calls a 'Pixmap'

### Warning

the API `ReadUpToTag` and `ReadSelectedTag`

### See also

[Pixmap](#)

## 10.232.2 Constructor & Destructor Documentation

### 10.232.2.1 PixmapReader()

```
gdcm::PixmapReader::PixmapReader ( )
```

### 10.232.2.2 ~PixmapReader()

```
gdcm::PixmapReader::~~PixmapReader ( ) [override]
```

## 10.232.3 Member Function Documentation

### 10.232.3.1 GetPixmap() [1/2]

```
Pixmap& gdcm::PixmapReader::GetPixmap ( )
```

### 10.232.3.2 GetPixmap() [2/2]

```
const Pixmap& gdcm::PixmapReader::GetPixmap ( ) const
```

Return the read image (need to call [Read\(\)](#) first)

### 10.232.3.3 Read()

```
bool gdcm::PixmapReader::Read ( ) [override], [virtual]
```

Read the DICOM image. There are two reason for failure:

1. The input filename is not DICOM
2. The input DICOM file does not contains an [Pixmap](#).

Reimplemented from [gdcm::Reader](#).

### 10.232.3.4 ReadACRNEMAIImage()

```
virtual bool gdcm::PixmapReader::ReadACRNEMAIImage ( ) [protected], [virtual]
```

Reimplemented in [gdcm::ImageReader](#).

### 10.232.3.5 ReadImage()

```
virtual bool gdcm::PixmapReader::ReadImage (
    MediaStorage const & ms ) [protected], [virtual]
```

Reimplemented in [gdcm::ImageReader](#).

### 10.232.3.6 ReadImageInternal()

```
bool gdcm::PixmapReader::ReadImageInternal (
    MediaStorage const & ms,
    bool handlepixeldata = true ) [protected]
```



## 10.232.4 Member Data Documentation

### 10.232.4.1 PixelData

```
SmartPointer<Pixmap> gdcm::PixmapReader::PixelData [protected]
```

The documentation for this class was generated from the following file:

- [gdcmPixmapReader.h](#)

## 10.233 gdcm::PixmapToPixmapFilter Class Reference

[PixmapToPixmapFilter](#) class.

```
#include <gdcmPixmapToPixmapFilter.h>
```

Inheritance diagram for gdcm::PixmapToPixmapFilter:

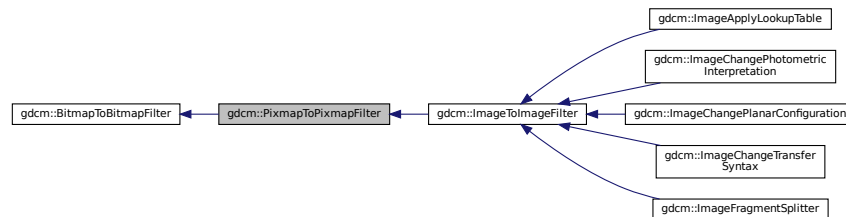

Collaboration diagram for `gdcm::PixmapToPixmapFilter`:

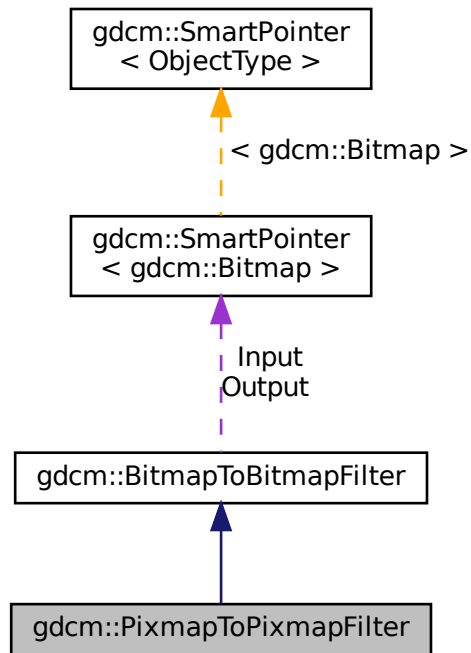

## Public Member Functions

- [PixmapToPixmapFilter](#) ()
- [~PixmapToPixmapFilter](#) ()=default
- [Pixmap](#) & [GetInput](#) ()
- const [Pixmap](#) & [GetOutput](#) () const  
*Get Output image.*
- const [Pixmap](#) & [GetOutputAsPixmap](#) () const

## Additional Inherited Members

### 10.233.1 Detailed Description

[PixmapToPixmapFilter](#) class.

Super class for all filter taking an image and producing an output image

## 10.233.2 Constructor & Destructor Documentation

### 10.233.2.1 PixmapToPixmapFilter()

```
gdcm::PixmapToPixmapFilter::PixmapToPixmapFilter ( )
```

### 10.233.2.2 ~PixmapToPixmapFilter()

```
gdcm::PixmapToPixmapFilter::~~PixmapToPixmapFilter ( ) [default]
```

## 10.233.3 Member Function Documentation

### 10.233.3.1 GetInput()

```
Pixmap& gdcm::PixmapToPixmapFilter::GetInput ( )
```

### 10.233.3.2 GetOutput()

```
const Pixmap& gdcm::PixmapToPixmapFilter::GetOutput ( ) const
```

Get Output image.

### 10.233.3.3 GetOutputAsPixmap()

```
const Pixmap& gdcm::PixmapToPixmapFilter::GetOutputAsPixmap ( ) const
```

The documentation for this class was generated from the following file:

- [gdcmPixmapToPixmapFilter.h](#)

## 10.234 gdcM::PixmapWriter Class Reference

[PixmapWriter](#).

```
#include <gdcMPixmapWriter.h>
```

Inheritance diagram for gdcM::PixmapWriter:

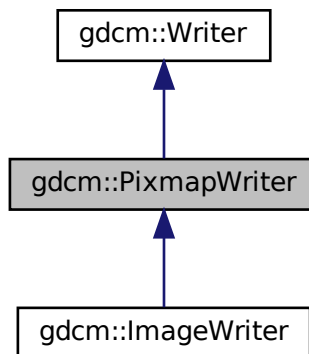

Collaboration diagram for gdcm::PixmapWriter:

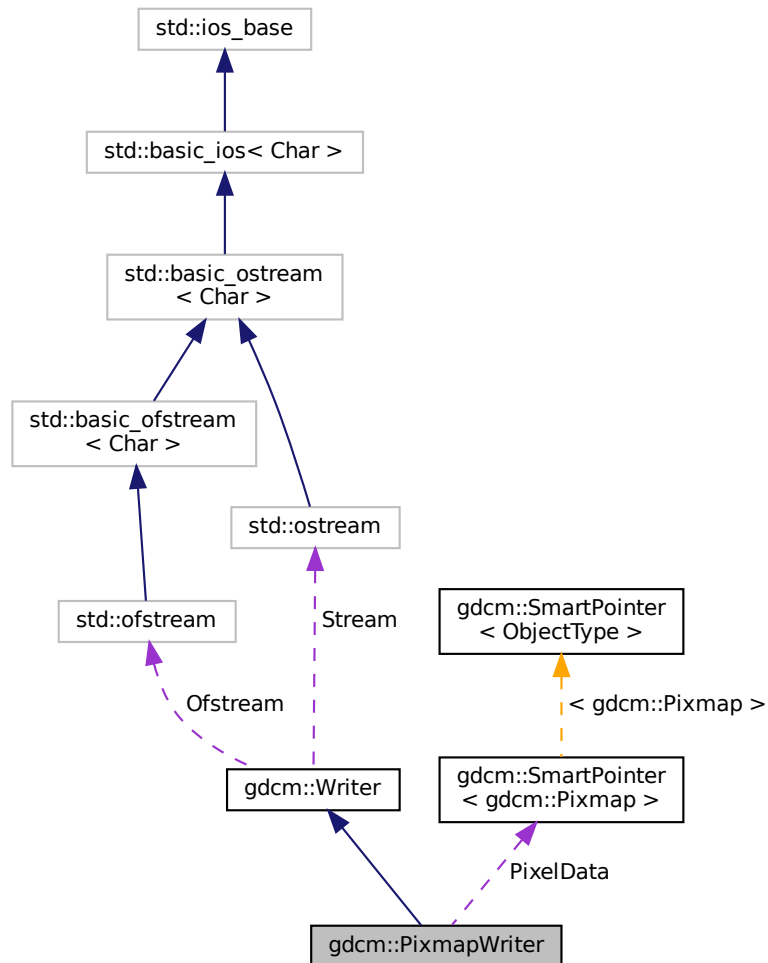

## Public Member Functions

- `PixmapWriter ()`
- `~PixmapWriter ()` override
- virtual `Pixmap & GetImage ()`
- virtual const `Pixmap & GetImage () const`
- `Pixmap & GetPixmap ()`
- const `Pixmap & GetPixmap () const`
- virtual void `SetImage (Pixmap const &img)`
- void `SetPixmap (Pixmap const &img)`
- bool `Write ()` override

*Write.*

## Protected Member Functions

- void [DolconImage](#) ([DataSet](#) &ds, [Pixmap](#) const &image)
- bool [PrepareWrite](#) ([MediaStorage](#) const &refms)

## Protected Attributes

- [SmartPointer](#)< [Pixmap](#) > [PixelData](#)

### 10.234.1 Detailed Description

[PixmapWriter](#).

This class will takes two inputs:

1. The DICOM [DataSet](#)
2. The [Image](#) input It will override any info from the [Image](#) over the [DataSet](#).

For instance when one read in a lossy compressed image and write out as unencapsulated (ie implicitly lossless) then some attribute are definitely needed to mark this dataset as Lossy (typically 0028,2114)

### 10.234.2 Constructor & Destructor Documentation

#### 10.234.2.1 PixmapWriter()

```
gdcM::PixmapWriter::PixmapWriter ( )
```

#### 10.234.2.2 ~PixmapWriter()

```
gdcM::PixmapWriter::~~PixmapWriter ( ) [override]
```

### 10.234.3 Member Function Documentation

### 10.234.3.1 DoIconImage()

```
void gdcm::PixmapWriter::DoIconImage (
    DataSet & ds,
    Pixmap const & image ) [protected]
```

### 10.234.3.2 GetImage() [1/2]

```
virtual Pixmap& gdcm::PixmapWriter::GetImage ( ) [inline], [virtual]
```

Reimplemented in [gdcm::ImageWriter](#).

### 10.234.3.3 GetImage() [2/2]

```
virtual const Pixmap& gdcm::PixmapWriter::GetImage ( ) const [inline], [virtual]
```

Set/Get [Pixmap](#) to be written It will overwrite anything [Pixmap](#) infos found in [DataSet](#) (see parent class to see how to pass dataset)

Reimplemented in [gdcm::ImageWriter](#).

### 10.234.3.4 GetPixmap() [1/2]

```
Pixmap& gdcm::PixmapWriter::GetPixmap ( ) [inline]
```

### 10.234.3.5 GetPixmap() [2/2]

```
const Pixmap& gdcm::PixmapWriter::GetPixmap ( ) const [inline]
```

### 10.234.3.6 PrepareWrite()

```
bool gdcm::PixmapWriter::PrepareWrite (
    MediaStorage const & refs ) [protected]
```

### 10.234.3.7 SetImage()

```
virtual void gdcM::PixmapWriter::SetImage (  
    Pixmap const & img ) [virtual]
```

#### Examples

[CompressImage.cxx](#), [GenFakeImage.cxx](#), [GetSubSequenceData.cxx](#), [HelloVizWorld.cxx](#), [MergeTwoFiles.cxx](#), and [TemplateEmptyImage.cxx](#).

### 10.234.3.8 SetPixmap()

```
void gdcM::PixmapWriter::SetPixmap (  
    Pixmap const & img )
```

### 10.234.3.9 Write()

```
bool gdcM::PixmapWriter::Write ( ) [override], [virtual]
```

Write.

Reimplemented from [gdcM::Writer](#).

## 10.234.4 Member Data Documentation

### 10.234.4.1 PixelData

```
SmartPointer<Pixmap> gdcM::PixmapWriter::PixelData [protected]
```

The documentation for this class was generated from the following file:

- [gdcMPixmapWriter.h](#)



## 10.235 gdcm::PNMCodec Class Reference

Class to do PNM.

```
#include <gdcmPNMCodec.h>
```

Inheritance diagram for gdcm::PNMCodec:

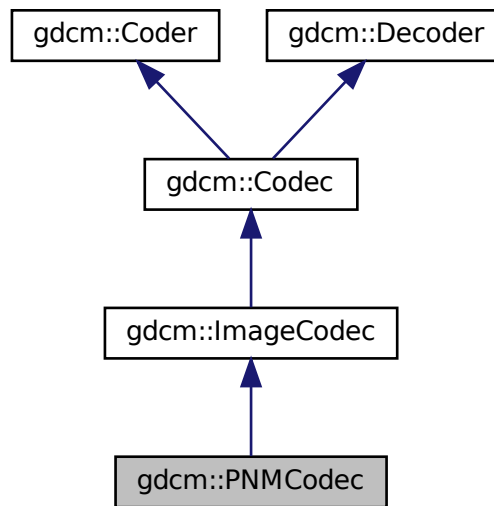

Collaboration diagram for gdcm::PNMCodec:

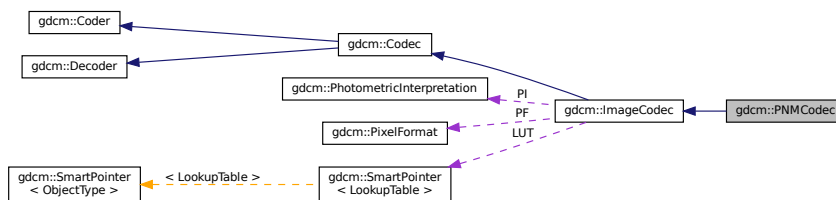

### Public Member Functions

- [PNMCodec](#) ()
- [~PNMCodec](#) () override
- bool [CanCode](#) ([TransferSyntax](#) const &ts) const override

*Return whether this coder support this transfer syntax (can code it)*

- bool `CanDecode` (`TransferSyntax` const &ts) const override

*Return whether this decoder support this transfer syntax (can decode it)*

- `ImageCodec` \* `Clone` () const override
- unsigned long `GetBufferLength` () const
- bool `GetHeaderInfo` (std::istream &is, `TransferSyntax` &ts) override
- bool `Read` (const char \*filename, `DataElement` &out) const
- void `SetBufferLength` (unsigned long l)
- bool `Write` (const char \*filename, const `DataElement` &out) const

## Additional Inherited Members

### 10.235.1 Detailed Description

Class to do PNM.

PNM is the Portable anymap file format. The main web page can be found at: <http://netpbm.sourceforge.net/>

#### Note

Only support P5 & P6 PNM file (binary grayscale and binary rgb)

#### Examples

[ExtractIconFromFile.cxx](#).

### 10.235.2 Constructor & Destructor Documentation

#### 10.235.2.1 PNMCodec()

```
gdcm::PNMCodec::PNMCodec ( )
```

#### 10.235.2.2 ~PNMCodec()

```
gdcm::PNMCodec::~~PNMCodec ( ) [override]
```

### 10.235.3 Member Function Documentation

### 10.235.3.1 CanCode()

```
bool gdcm::PNMCodec::CanCode (
    TransferSyntax const & ) const [override], [virtual]
```

Return whether this coder support this transfer syntax (can code it)

Reimplemented from [gdcm::ImageCodec](#).

### 10.235.3.2 CanDecode()

```
bool gdcm::PNMCodec::CanDecode (
    TransferSyntax const & ) const [override], [virtual]
```

Return whether this decoder support this transfer syntax (can decode it)

Reimplemented from [gdcm::ImageCodec](#).

### 10.235.3.3 Clone()

```
ImageCodec* gdcm::PNMCodec::Clone ( ) const [override], [virtual]
```

Implements [gdcm::ImageCodec](#).

### 10.235.3.4 GetBufferLength()

```
unsigned long gdcm::PNMCodec::GetBufferLength ( ) const [inline]
```

### 10.235.3.5 GetHeaderInfo()

```
bool gdcm::PNMCodec::GetHeaderInfo (
    std::istream & is,
    TransferSyntax & ts ) [override], [virtual]
```

Reimplemented from [gdcm::ImageCodec](#).

### 10.235.3.6 Read()

```
bool gdcM::PNMCodec::Read (
    const char * filename,
    DataElement & out ) const
```

### 10.235.3.7 SetBufferLength()

```
void gdcM::PNMCodec::SetBufferLength (
    unsigned long l ) [inline]
```

### 10.235.3.8 Write()

```
bool gdcM::PNMCodec::Write (
    const char * filename,
    const DataElement & out ) const
```

#### Examples

[ExtractIconFromFile.cxx](#).

The documentation for this class was generated from the following file:

- [gdcMPNMCodec.h](#)

## 10.236 gdcM::Preamble Class Reference

DICOM [Preamble](#) (Part 10)

```
#include <gdcMPreamble.h>
```

## Public Member Functions

- [Preamble](#) ()
- [Preamble](#) ([Preamble](#) const &)
- [~Preamble](#) ()
- void [Clear](#) ()  
*Clear.*
- void [Create](#) ()
- const char \* [GetInternal](#) () const  
*Get internal pointer to preamble.*
- [VL GetLength](#) () const  
*Return size of [Preamble](#).*
- bool [IsEmpty](#) () const  
*Check if [Preamble](#) is empty.*
- [Preamble](#) & [operator=](#) ([Preamble](#) const &)
- void [Print](#) (std::ostream &os) const  
*Print [Preamble](#).*
- std::istream & [Read](#) (std::istream &is)  
*Read [Preamble](#).*
- void [Remove](#) ()
- void [Valid](#) ()  
*Set [Preamble](#) to the default one.*
- std::ostream const & [Write](#) (std::ostream &os) const  
*Write [Preamble](#).*

## Protected Member Functions

- bool [IsValid](#) () const

## Friends

- std::ostream & [operator<<](#) (std::ostream &\_os, const [Preamble](#) &\_val)

### 10.236.1 Detailed Description

DICOM [Preamble](#) (Part 10)

### 10.236.2 Constructor & Destructor Documentation

### 10.236.2.1 Preamble() [1/2]

```
gdcM::Preamble::Preamble ( )
```

### 10.236.2.2 ~Preamble()

```
gdcM::Preamble::~~Preamble ( )
```

### 10.236.2.3 Preamble() [2/2]

```
gdcM::Preamble::Preamble (
    Preamble const & ) [inline]
```

## 10.236.3 Member Function Documentation

### 10.236.3.1 Clear()

```
void gdcM::Preamble::Clear ( )
```

Clear.

### 10.236.3.2 Create()

```
void gdcM::Preamble::Create ( )
```

### 10.236.3.3 GetInternal()

```
const char* gdcM::Preamble::GetInternal ( ) const [inline]
```

Get internal pointer to preamble.

#### 10.236.3.4 GetLength()

```
VL gdcM::Preamble::GetLength ( ) const [inline]
```

Return size of [Preamble](#).

#### 10.236.3.5 IsEmpty()

```
bool gdcM::Preamble::IsEmpty ( ) const [inline]
```

Check if [Preamble](#) is empty.

#### 10.236.3.6 IsValid()

```
bool gdcM::Preamble::IsValid ( ) const [inline], [protected]
```

#### 10.236.3.7 operator=()

```
Preamble& gdcM::Preamble::operator= (
    Preamble const & ) [inline]
```

#### 10.236.3.8 Print()

```
void gdcM::Preamble::Print (
    std::ostream & os ) const
```

Print [Preamble](#).

#### 10.236.3.9 Read()

```
std::istream& gdcM::Preamble::Read (
    std::istream & is )
```

Read [Preamble](#).

### 10.236.3.10 Remove()

```
void gdcM::Preamble::Remove ( )
```

### 10.236.3.11 Valid()

```
void gdcM::Preamble::Valid ( )
```

Set [Preamble](#) to the default one.

### 10.236.3.12 Write()

```
std::ostream const& gdcM::Preamble::Write (
    std::ostream & os ) const
```

Write [Preamble](#).

## 10.236.4 Friends And Related Function Documentation

### 10.236.4.1 operator<<

```
std::ostream& operator<< (
    std::ostream & _os,
    const Preamble & _val ) [friend]
```

The documentation for this class was generated from the following file:

- [gdcMPreamble.h](#)



## 10.237 gdcm::PresentationContext Class Reference

[PresentationContext](#).

```
#include <gdcmPresentationContext.h>
```

Collaboration diagram for gdcm::PresentationContext:

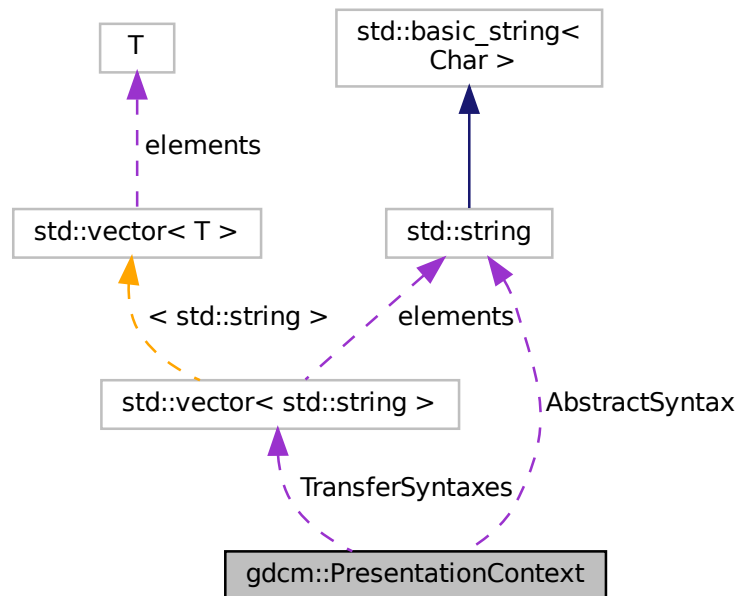

### Public Types

- typedef TransferSyntaxArrayType::size\_type [SizeType](#)
- typedef std::vector< std::string > [TransferSyntaxArrayType](#)

### Public Member Functions

- [PresentationContext](#) ()
- [PresentationContext](#) (UIDs::TSName asname, UIDs::TSName tname=UIDs::ImplicitVRLittleEndianDefaultTransferSyntaxforDICOM)
- void [AddTransferSyntax](#) (const char \*sstr)
- const char \* [GetAbstractSyntax](#) () const
- [SizeType](#) [GetNumberOfTransferSyntaxes](#) () const
- uint8\_t [GetPresentationContextID](#) () const
- const char \* [GetTransferSyntax](#) ([SizeType](#) i) const
- bool [operator==](#) (const [PresentationContext](#) &pc) const
- void [Print](#) (std::ostream &os) const
- void [SetAbstractSyntax](#) (const char \*absyn)
- void [SetPresentationContextID](#) (uint8\_t id)

## Protected Attributes

- `std::string` [AbstractSyntax](#)
- `uint8_t` [ID](#)
- `std::vector< std::string >` [TransferSyntaxes](#)

### 10.237.1 Detailed Description

[PresentationContext](#).

See also

[PresentationContextAC](#) [PresentationContextRQ](#)

### 10.237.2 Member Typedef Documentation

#### 10.237.2.1 SizeType

```
typedef TransferSyntaxArrayType::size_type gdc::PresentationContext::SizeType
```

#### 10.237.2.2 TransferSyntaxArrayType

```
typedef std::vector<std::string> gdc::PresentationContext::TransferSyntaxArrayType
```

### 10.237.3 Constructor & Destructor Documentation

#### 10.237.3.1 PresentationContext() [1/2]

```
gdc::PresentationContext::PresentationContext ( )
```

### 10.237.3.2 PresentationContext() [2/2]

```
gdcm::PresentationContext::PresentationContext (
    UIDs::TSName asname,
    UIDs::TSName tsname = UIDs::ImplicitVRLittleEndianDefaultTransferSyntaxforDICOM )
```

Initialize Presentation Context with AbstractSyntax set to asname and with a single [TransferSyntax](#) set to tsname (default to Implicit [VR](#) LittleEndian when not specified ).

## 10.237.4 Member Function Documentation

### 10.237.4.1 AddTransferSyntax()

```
void gdcm::PresentationContext::AddTransferSyntax (
    const char * tsstr )
```

### 10.237.4.2 GetAbstractSyntax()

```
const char* gdcm::PresentationContext::GetAbstractSyntax ( ) const [inline]
```

### 10.237.4.3 GetNumberOfTransferSyntaxes()

```
SizeType gdcm::PresentationContext::GetNumberOfTransferSyntaxes ( ) const [inline]
```

### 10.237.4.4 GetPresentationContextID()

```
uint8_t gdcm::PresentationContext::GetPresentationContextID ( ) const
```

### 10.237.4.5 GetTransferSyntax()

```
const char* gdcm::PresentationContext::GetTransferSyntax (
    SizeType i ) const [inline]
```

#### 10.237.4.6 operator==( )

```
bool gdcmm::PresentationContext::operator==(
    const PresentationContext & pc ) const [inline]
```

References AbstractSyntax, and TransferSyntaxes.

#### 10.237.4.7 Print( )

```
void gdcmm::PresentationContext::Print (
    std::ostream & os ) const
```

#### 10.237.4.8 SetAbstractSyntax( )

```
void gdcmm::PresentationContext::SetAbstractSyntax (
    const char * absyn ) [inline]
```

#### 10.237.4.9 SetPresentationContextID( )

```
void gdcmm::PresentationContext::SetPresentationContextID (
    uint8_t id )
```

### 10.237.5 Member Data Documentation

#### 10.237.5.1 AbstractSyntax

```
std::string gdcmm::PresentationContext::AbstractSyntax [protected]
```

Referenced by operator==( ).

#### 10.237.5.2 ID

```
uint8_t gdcmm::PresentationContext::ID [protected]
```

### 10.237.5.3 TransferSyntaxes

```
std::vector<std::string> gdcm::PresentationContext::TransferSyntaxes [protected]
```

Referenced by operator==().

The documentation for this class was generated from the following file:

- [gdcmPresentationContext.h](#)

## 10.238 gdcm::network::PresentationContextAC Class Reference

[PresentationContextAC](#).

```
#include <gdcmPresentationContextAC.h>
```

### Public Member Functions

- [PresentationContextAC](#) ()
- [uint8\\_t GetPresentationContextID](#) () const
- [uint8\\_t GetReason](#) () const
- [TransferSyntaxSub](#) const & [GetTransferSyntax](#) () const
- void [Print](#) (std::ostream &os) const
- std::istream & [Read](#) (std::istream &is)
- void [SetPresentationContextID](#) (uint8\_t id)
- void [SetReason](#) (uint8\_t r)
- void [SetTransferSyntax](#) ([TransferSyntaxSub](#) const &ts)
- [size\\_t Size](#) () const
- const std::ostream & [Write](#) (std::ostream &os) const

### 10.238.1 Detailed Description

[PresentationContextAC](#).

[Table 9-18 PRESENTATION CONTEXT ITEM FIELDS](#)

See also

[PresentationContext](#)

### 10.238.2 Constructor & Destructor Documentation

### 10.238.2.1 PresentationContextAC()

```
gdcmm::network::PresentationContextAC::PresentationContextAC ( )
```

## 10.238.3 Member Function Documentation

### 10.238.3.1 GetPresentationContextID()

```
uint8_t gdcmm::network::PresentationContextAC::GetPresentationContextID ( ) const [inline]
```

### 10.238.3.2 GetReason()

```
uint8_t gdcmm::network::PresentationContextAC::GetReason ( ) const [inline]
```

### 10.238.3.3 GetTransferSyntax()

```
TransferSyntaxSub const& gdcmm::network::PresentationContextAC::GetTransferSyntax ( ) const [inline]
```

### 10.238.3.4 Print()

```
void gdcmm::network::PresentationContextAC::Print (
    std::ostream & os ) const
```

### 10.238.3.5 Read()

```
std::istream& gdcmm::network::PresentationContextAC::Read (
    std::istream & is )
```

### 10.238.3.6 SetPresentationContextID()

```
void gdcM::network::PresentationContextAC::SetPresentationContextID (
    uint8_t id )
```

### 10.238.3.7 SetReason()

```
void gdcM::network::PresentationContextAC::SetReason (
    uint8_t r ) [inline]
```

### 10.238.3.8 SetTransferSyntax()

```
void gdcM::network::PresentationContextAC::SetTransferSyntax (
    TransferSyntaxSub const & ts )
```

### 10.238.3.9 Size()

```
size_t gdcM::network::PresentationContextAC::Size ( ) const
```

### 10.238.3.10 Write()

```
const std::ostream& gdcM::network::PresentationContextAC::Write (
    std::ostream & os ) const
```

The documentation for this class was generated from the following file:

- [gdcMPresentationContextAC.h](#)

## 10.239 gdcM::PresentationContextGenerator Class Reference

[PresentationContextGenerator](#).

```
#include <gdcMPresentationContextGenerator.h>
```

## Public Types

- typedef std::vector< [PresentationContext](#) > [PresentationContextArrayType](#)
- typedef [PresentationContextArrayType](#)::size\_type [SizeType](#)

## Public Member Functions

- [PresentationContextGenerator](#) ()
- bool [AddFromFile](#) (const [File](#) &file)
- bool [GenerateFromFilenames](#) (const [Directory::FilenamesType](#) &files)
- bool [GenerateFromUID](#) ([UIDs::TSName](#) asname)
  - *Generate the [PresentationContext](#) array from a UID (eg. [VerificationSOPClass](#))*
- [PresentationContextArrayType](#) const & [GetPresentationContexts](#) ()
- void [SetDefaultTransferSyntax](#) (const [TransferSyntax](#) &ts)
  - *Not implemented for now. GDCM internally uses Implicit Little Endian.*
- void [SetMergeModeToAbstractSyntax](#) ()
- void [SetMergeModeToTransferSyntax](#) ()

## Protected Member Functions

- bool [AddPresentationContext](#) (const char \*absyn, const char \*ts)
- const char \* [GetDefaultTransferSyntax](#) () const

### 10.239.1 Detailed Description

#### [PresentationContextGenerator](#).

This class is responsible for generating the proper [PresentationContext](#) that will be used in subsequent operation during a DICOM Query/Retrieve association. The step of the association is very sensible as special care need to be taken to explicitly define what instance are going to be send and how they are encoded.

For example a [PresentationContext](#) will express that negotiation requires that CT [Image](#) Storage are send using JPEG Lossless, while US [Image](#) Storage are sent using RLE Transfer Syntax.

Two very different API are exposed one which will always default to little endian transfer syntax see [GenerateFromUID\(\)](#) This API is used for C-ECHO, C-FIND and C-MOVE (SCU). Another API: [GenerateFromFilenames\(\)](#) is used for C-↔ STORE (SCU) as it will loop over all filenames argument to detect the actual encoding. and therefore find the proper encoding to be used.

Two modes are available. The default mode ([SetMergeModeToAbstractSyntax](#)) append [PresentationContext](#) (one [AbstractSyntax](#) and one [TransferSyntax](#)), as long a they are different. Eg MR [Image](#) Storage/JPEG2000 and MR [Image](#) Storage/JPEGLossless would be considered different. the other mode [SetMergeModeToTransferSyntax](#) merge any new [TransferSyntax](#) to the already existing [PresentationContext](#) in order to re-use the same [AbstractSyntax](#).

See also

[PresentationContext](#)

Examples

[CStoreQtProgress.cxx](#).



## 10.239.2 Member Typedef Documentation

### 10.239.2.1 PresentationContextArrayType

```
typedef std::vector<PresentationContext> gdcmm::PresentationContextGenerator::PresentationContextArrayType
```

### 10.239.2.2 SizeType

```
typedef PresentationContextArrayType::size_type gdcmm::PresentationContextGenerator::SizeType
```

## 10.239.3 Constructor & Destructor Documentation

### 10.239.3.1 PresentationContextGenerator()

```
gdcmm::PresentationContextGenerator::PresentationContextGenerator ( )
```

## 10.239.4 Member Function Documentation

### 10.239.4.1 AddFromFile()

```
bool gdcmm::PresentationContextGenerator::AddFromFile (
    const File & file )
```

Add a single [PresentationContext](#) from a single [File](#). Call multiple times when dealing with multiple files.

### 10.239.4.2 AddPresentationContext()

```
bool gdcmm::PresentationContextGenerator::AddPresentationContext (
    const char * absyn,
    const char * ts ) [protected]
```

#### 10.239.4.3 GenerateFromFileNames()

```
bool gdcmm::PresentationContextGenerator::GenerateFromFileNames (
    const Directory::FileNamesType & files )
```

Generate the [PresentationContext](#) array from a File-Set. [File](#) specified needs to be valid DICOM files. Used for C↔STORE operations

##### Examples

[CStoreQtProgress.cxx](#).

#### 10.239.4.4 GenerateFromUID()

```
bool gdcmm::PresentationContextGenerator::GenerateFromUID (
    UIDs::TSName asname )
```

Generate the [PresentationContext](#) array from a UID (eg. VerificationSOPClass)

#### 10.239.4.5 GetDefaultTransferSyntax()

```
const char* gdcmm::PresentationContextGenerator::GetDefaultTransferSyntax ( ) const [protected]
```

#### 10.239.4.6 GetPresentationContexts()

```
PresentationContextArrayType const& gdcmm::PresentationContextGenerator::GetPresentationContexts (
) [inline]
```

##### Examples

[CStoreQtProgress.cxx](#).

#### 10.239.4.7 SetDefaultTransferSyntax()

```
void gdcmm::PresentationContextGenerator::SetDefaultTransferSyntax (
    const TransferSyntax & ts )
```

Not implemented for now. GDCM internally uses Implicit Little Endian.

**10.239.4.8 SetMergeModeToAbstractSyntax()**

```
void gdcm::PresentationContextGenerator::SetMergeModeToAbstractSyntax ( )
```

**10.239.4.9 SetMergeModeToTransferSyntax()**

```
void gdcm::PresentationContextGenerator::SetMergeModeToTransferSyntax ( )
```

The documentation for this class was generated from the following file:

- [gdcmPresentationContextGenerator.h](#)

**10.240 gdcm::network::PresentationContextRQ Class Reference**

[PresentationContextRQ](#).

```
#include <gdcmPresentationContextRQ.h>
```

**Public Types**

- typedef std::vector< [TransferSyntaxSub](#) >::size\_type [SizeType](#)

**Public Member Functions**

- [PresentationContextRQ](#) ( )
- [PresentationContextRQ](#) (const [PresentationContext](#) &pc)
- [PresentationContextRQ](#) ([UIDs::TSName](#) asname, [UIDs::TSName](#) tsname=[UIDs::ImplicitVRLittleEndianDefaultTransferSyntaxforDICOM](#))
- void [AddTransferSyntax](#) ([TransferSyntaxSub](#) const &ts)
- [AbstractSyntax](#) & [GetAbstractSyntax](#) ( )
- [AbstractSyntax](#) const & [GetAbstractSyntax](#) ( ) const
- [SizeType](#) [GetNumberOfTransferSyntaxes](#) ( ) const
- uint8\_t [GetPresentationContextID](#) ( ) const
- [TransferSyntaxSub](#) & [GetTransferSyntax](#) ([SizeType](#) i)
- [TransferSyntaxSub](#) const & [GetTransferSyntax](#) ([SizeType](#) i) const
- std::vector< [TransferSyntaxSub](#) > const & [GetTransferSyntaxes](#) ( ) const
- bool [operator==](#) (const [PresentationContextRQ](#) &pc) const
- void [Print](#) (std::ostream &os) const
- std::istream & [Read](#) (std::istream &is)
- void [SetAbstractSyntax](#) ([AbstractSyntax](#) const &absyn)
- void [SetPresentationContextID](#) (uint8\_t id)
- size\_t [Size](#) ( ) const
- const std::ostream & [Write](#) (std::ostream &os) const

## 10.240.1 Detailed Description

[PresentationContextRQ](#).

[Table 9-13 PRESENTATION CONTEXT ITEM FIELDS](#)

See also

[PresentationContextAC](#)

## 10.240.2 Member Typedef Documentation

### 10.240.2.1 SizeType

```
typedef std::vector<TransferSyntaxSub>::size_type gdcm::network::PresentationContextRQ::SizeType
```

## 10.240.3 Constructor & Destructor Documentation

### 10.240.3.1 PresentationContextRQ() [1/3]

```
gdcm::network::PresentationContextRQ::PresentationContextRQ ( )
```

### 10.240.3.2 PresentationContextRQ() [2/3]

```
gdcm::network::PresentationContextRQ::PresentationContextRQ (
    UIDs::TSName asname,
    UIDs::TSName tsname = UIDs::ImplicitVRLittleEndianDefaultTransferSyntaxforDICOM )
```

Initialize Presentation Context with [AbstractSyntax](#) set to *asname* and with a single [TransferSyntax](#) set to *tsname* (default to Implicit [VR](#) LittleEndian when not specified).

### 10.240.3.3 PresentationContextRQ() [3/3]

```
gdcm::network::PresentationContextRQ::PresentationContextRQ (
    const PresentationContext & pc )
```

## 10.240.4 Member Function Documentation

### 10.240.4.1 AddTransferSyntax()

```
void gdcm::network::PresentationContextRQ::AddTransferSyntax (
    TransferSyntaxSub const & ts )
```

### 10.240.4.2 GetAbstractSyntax() [1/2]

```
AbstractSyntax& gdcm::network::PresentationContextRQ::GetAbstractSyntax ( ) [inline]
```

### 10.240.4.3 GetAbstractSyntax() [2/2]

```
AbstractSyntax const& gdcm::network::PresentationContextRQ::GetAbstractSyntax ( ) const [inline]
```

### 10.240.4.4 GetNumberOfTransferSyntaxes()

```
SizeType gdcm::network::PresentationContextRQ::GetNumberOfTransferSyntaxes ( ) const [inline]
```

### 10.240.4.5 GetPresentationContextID()

```
uint8_t gdcm::network::PresentationContextRQ::GetPresentationContextID ( ) const
```

### 10.240.4.6 GetTransferSyntax() [1/2]

```
TransferSyntaxSub& gdcm::network::PresentationContextRQ::GetTransferSyntax (
    SizeType i ) [inline]
```

#### 10.240.4.7 GetTransferSyntax() [2/2]

```
TransferSyntaxSub const& gdcM::network::PresentationContextRQ::GetTransferSyntax (
    SizeType i ) const [inline]
```

#### 10.240.4.8 GetTransferSyntaxes()

```
std::vector<TransferSyntaxSub> const& gdcM::network::PresentationContextRQ::GetTransferSyntaxes (
) const [inline]
```

#### 10.240.4.9 operator==()

```
bool gdcM::network::PresentationContextRQ::operator== (
    const PresentationContextRQ & pc ) const [inline]
```

#### 10.240.4.10 Print()

```
void gdcM::network::PresentationContextRQ::Print (
    std::ostream & os ) const
```

#### 10.240.4.11 Read()

```
std::istream& gdcM::network::PresentationContextRQ::Read (
    std::istream & is )
```

#### 10.240.4.12 SetAbstractSyntax()

```
void gdcM::network::PresentationContextRQ::SetAbstractSyntax (
    AbstractSyntax const & absyn )
```

**10.240.4.13 SetPresentationContextID()**

```
void gdcm::network::PresentationContextRQ::SetPresentationContextID (
    uint8_t id )
```

**10.240.4.14 Size()**

```
size_t gdcm::network::PresentationContextRQ::Size ( ) const
```

**10.240.4.15 Write()**

```
const std::ostream& gdcm::network::PresentationContextRQ::Write (
    std::ostream & os ) const
```

The documentation for this class was generated from the following file:

- [gdcmPresentationContextRQ.h](#)

**10.241 gdcm::network::PresentationDataValue Class Reference**

[PresentationDataValue](#).

```
#include <gdcmPresentationDataValue.h>
```

**Public Member Functions**

- [PresentationDataValue](#) ()
- const std::string & [GetBlob](#) () const
- bool [GetIsCommand](#) () const
- bool [GetIsLastFragment](#) () const
- uint8\_t [GetMessageHeader](#) () const
- uint8\_t [GetPresentationContextID](#) () const
- void [Print](#) (std::ostream &os) const
- std::istream & [Read](#) (std::istream &is)
- std::istream & [ReadInto](#) (std::istream &is, std::ostream &os)
- void [SetBlob](#) (const std::string &partialblob)
- void [SetCommand](#) (bool inCommand)
- void [SetDataSet](#) (const [DataSet](#) &ds)
- void [SetLastFragment](#) (bool inLast)
- void [SetMessageHeader](#) (uint8\_t messageheader)
- void [SetPresentationContextID](#) (uint8\_t id)
- size\_t [Size](#) () const
- const std::ostream & [Write](#) (std::ostream &os) const

## Static Public Member Functions

- static [DataSet ConcatenatePDVBlobs](#) (const std::vector< [PresentationDataValue](#) > &inPDVs)
- static [DataSet ConcatenatePDVBlobsAsExplicit](#) (const std::vector< [PresentationDataValue](#) > &inPDVs)

### 10.241.1 Detailed Description

[PresentationDataValue](#).

[Table 9-23 PRESENTATION-DATA-VALUE ITEM FIELDS](#)

### 10.241.2 Constructor & Destructor Documentation

#### 10.241.2.1 PresentationDataValue()

```
gdcM::network::PresentationDataValue::PresentationDataValue ( )
```

### 10.241.3 Member Function Documentation

#### 10.241.3.1 ConcatenatePDVBlobs()

```
static DataSet gdcM::network::PresentationDataValue::ConcatenatePDVBlobs (
    const std::vector< PresentationDataValue > & inPDVs ) [static]
```

#### Warning

[DataSet](#) will be read as Implicit Little Endian TS

#### 10.241.3.2 ConcatenatePDVBlobsAsExplicit()

```
static DataSet gdcM::network::PresentationDataValue::ConcatenatePDVBlobsAsExplicit (
    const std::vector< PresentationDataValue > & inPDVs ) [static]
```



### 10.241.3.3 GetBlob()

```
const std::string& gdcm::network::PresentationDataValue::GetBlob ( ) const
```

### 10.241.3.4 GetIsCommand()

```
bool gdcm::network::PresentationDataValue::GetIsCommand ( ) const
```

### 10.241.3.5 GetIsLastFragment()

```
bool gdcm::network::PresentationDataValue::GetIsLastFragment ( ) const
```

### 10.241.3.6 GetMessageHeader()

```
uint8_t gdcm::network::PresentationDataValue::GetMessageHeader ( ) const [inline]
```

### 10.241.3.7 GetPresentationContextID()

```
uint8_t gdcm::network::PresentationDataValue::GetPresentationContextID ( ) const [inline]
```

### 10.241.3.8 Print()

```
void gdcm::network::PresentationDataValue::Print (
    std::ostream & os ) const
```

### 10.241.3.9 Read()

```
std::istream& gdcm::network::PresentationDataValue::Read (
    std::istream & is )
```

#### 10.241.3.10 ReadInto()

```
std::istream& gdcM::network::PresentationDataValue::ReadInto (
    std::istream & is,
    std::ostream & os )
```

#### 10.241.3.11 SetBlob()

```
void gdcM::network::PresentationDataValue::SetBlob (
    const std::string & partialblob )
```

#### 10.241.3.12 SetCommand()

```
void gdcM::network::PresentationDataValue::SetCommand (
    bool inCommand )
```

#### 10.241.3.13 SetDataSet()

```
void gdcM::network::PresentationDataValue::SetDataSet (
    const DataSet & ds )
```

Set [DataSet](#). Write [DataSet](#) in implicit.

#### Warning

size of dataset should be below maxpdusize

#### 10.241.3.14 SetLastFragment()

```
void gdcM::network::PresentationDataValue::SetLastFragment (
    bool inLast )
```

### 10.241.3.15 SetMessageHeader()

```
void gdcm::network::PresentationDataValue::SetMessageHeader (
    uint8_t messageheader ) [inline]
```

### 10.241.3.16 SetPresentationContextID()

```
void gdcm::network::PresentationDataValue::SetPresentationContextID (
    uint8_t id ) [inline]
```

### 10.241.3.17 Size()

```
size_t gdcm::network::PresentationDataValue::Size ( ) const
```

### 10.241.3.18 Write()

```
const std::ostream& gdcm::network::PresentationDataValue::Write (
    std::ostream & os ) const
```

The documentation for this class was generated from the following file:

- [gdcmPresentationDataValue.h](#)

## 10.242 gdcm::Printer Class Reference

[Printer](#) class.

```
#include <gdcmPrinter.h>
```

Inheritance diagram for gdcm::Printer:

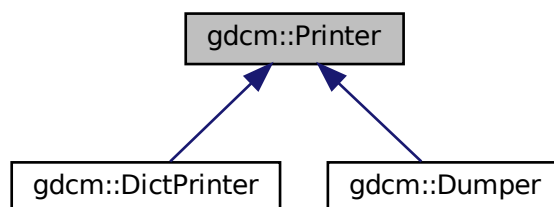

Collaboration diagram for `gdcM::Printer`:

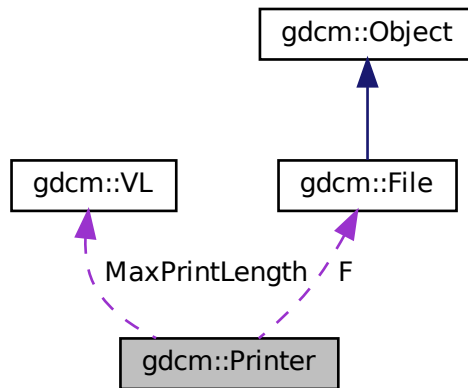

## Public Types

- enum `PrintStyles` {  
`VERBOSE_STYLE = 0` ,  
`CONDENSED_STYLE` ,  
`XML` ,  
`CXX` }

## Public Member Functions

- `Printer ()`
- `~Printer ()`
- `PrintStyles GetPrintStyle () const`  
*Get PrintStyle value.*
- `void Print (std::ostream &os)`  
*Print.*
- `void PrintDataSet (const DataSet &ds, std::ostream &os, const std::string &s="")`  
*Print an individual dataset.*
- `void SetColor (bool c)`  
*Set color mode or not.*
- `void SetFile (File const &f)`  
*Set file.*
- `void SetStyle (PrintStyles ps)`  
*Set PrintStyle value.*

## Protected Member Functions

- [VR PrintDataElement](#) (std::ostream &os, const [Dicts](#) &dicts, const [DataSet](#) &ds, const [DataElement](#) &de, std::ostream &out, std::string const &indent)
- void [PrintSQ](#) (const [SequenceOfItems](#) \*sqi, std::ostream &os, std::string const &indent)

## Protected Attributes

- const [File](#) \* F
- [VL MaxPrintLength](#)
- [PrintStyles](#) [PrintStyle](#)

### 10.242.1 Detailed Description

[Printer](#) class.

#### Examples

[DumpSiemensBase64.cxx](#), [DumpToshibaDTI.cxx](#), and [DumpToshibaDTI2.cxx](#).

### 10.242.2 Member Enumeration Documentation

#### 10.242.2.1 PrintStyles

```
enum gdcM::Printer::PrintStyles
```

##### Enumerator

VERBOSE_STYLE	
CONDENSED_STYLE	
XML	
CXX	

### 10.242.3 Constructor & Destructor Documentation

#### 10.242.3.1 Printer()

```
gdcM::Printer::Printer ( )
```

### 10.242.3.2 ~Printer()

```
gdcM::Printer::~~Printer ( )
```

## 10.242.4 Member Function Documentation

### 10.242.4.1 GetPrintStyle()

```
PrintStyle gdcM::Printer::GetPrintStyle ( ) const [inline]
```

Get PrintStyle value.

### 10.242.4.2 Print()

```
void gdcM::Printer::Print (
    std::ostream & os )
```

Print.

#### Examples

[DumpSiemensBase64.cxx](#).

### 10.242.4.3 PrintDataElement()

```
VR gdcM::Printer::PrintDataElement (
    std::ostringstream & os,
    const Dicts & dicts,
    const DataSet & ds,
    const DataElement & de,
    std::ostream & out,
    std::string const & indent ) [protected]
```

#### 10.242.4.4 PrintDataSet()

```
void gdcM::Printer::PrintDataSet (
    const DataSet & ds,
    std::ostream & os,
    const std::string & s = "" )
```

Print an individual dataset.

#### 10.242.4.5 PrintSQ()

```
void gdcM::Printer::PrintSQ (
    const SequenceOfItems * sqi,
    std::ostream & os,
    std::string const & indent ) [protected]
```

#### 10.242.4.6 SetColor()

```
void gdcM::Printer::SetColor (
    bool c )
```

Set color mode or not.

#### 10.242.4.7 SetFile()

```
void gdcM::Printer::SetFile (
    File const & f ) [inline]
```

Set file.

#### Examples

[DumpSiemensBase64.cxx](#), [DumpToshibaDTI.cxx](#), and [DumpToshibaDTI2.cxx](#).

#### 10.242.4.8 SetStyle()

```
void gdcM::Printer::SetStyle (
    PrintStyles ps ) [inline]
```

Set PrintStyle value.

## 10.242.5 Member Data Documentation

### 10.242.5.1 F

```
const File* gdcM::Printer::F [protected]
```

### 10.242.5.2 MaxPrintLength

```
VL gdcM::Printer::MaxPrintLength [protected]
```

### 10.242.5.3 PrintStyle

```
PrintStyles gdcM::Printer::PrintStyle [protected]
```

The documentation for this class was generated from the following file:

- [gdcMPrinter.h](#)

## 10.243 gdcM::PrivateDict Class Reference

Private [Dict](#).

```
#include <gdcMDict.h>
```

### Public Member Functions

- [PrivateDict](#) ()=default
- [~PrivateDict](#) ()=default
- void [AddDictEntry](#) (const [PrivateTag](#) &tag, const [DictEntry](#) &de)
- bool [FindDictEntry](#) (const [PrivateTag](#) &tag) const
- const [DictEntry](#) & [GetDictEntry](#) (const [PrivateTag](#) &tag) const
- bool [IsEmpty](#) () const
- void [PrintXML](#) () const
- bool [RemoveDictEntry](#) (const [PrivateTag](#) &tag)



## Protected Member Functions

- void [LoadDefault](#) ()

## Friends

- class [Dicts](#)
- std::ostream & [operator<<](#) (std::ostream &os, const [PrivateDict](#) &val)

### 10.243.1 Detailed Description

Private [Dict](#).

### 10.243.2 Constructor & Destructor Documentation

#### 10.243.2.1 PrivateDict()

```
gdcM::PrivateDict::PrivateDict ( ) [default]
```

#### 10.243.2.2 ~PrivateDict()

```
gdcM::PrivateDict::~~PrivateDict ( ) [default]
```

### 10.243.3 Member Function Documentation

#### 10.243.3.1 AddDictEntry()

```
void gdcM::PrivateDict::AddDictEntry (
    const PrivateTag & tag,
    const DictEntry & de ) [inline]
```

References [gdcM::DictEntry::GetVM\(\)](#), [gdcM::DictEntry::GetVR\(\)](#), [gdcM::DictEntry::SetVM\(\)](#), [gdcM::DictEntry::SetVR\(\)](#), and [gdcM::VR::UN](#).

### 10.243.3.2 FindDictEntry()

```
bool gdcM::PrivateDict::FindDictEntry (
    const PrivateTag & tag ) const [inline]
```

### 10.243.3.3 GetDictEntry()

```
const DictEntry& gdcM::PrivateDict::GetDictEntry (
    const PrivateTag & tag ) const [inline]
```

### 10.243.3.4 IsEmpty()

```
bool gdcM::PrivateDict::IsEmpty ( ) const [inline]
```

### 10.243.3.5 LoadDefault()

```
void gdcM::PrivateDict::LoadDefault ( ) [protected]
```

### 10.243.3.6 PrintXML()

```
void gdcM::PrivateDict::PrintXML ( ) const [inline]
```

References `gdcM::Tag::GetElement()`, `gdcM::Tag::GetGroup()`, `gdcM::DictEntry::GetName()`, `gdcM::PrivateTag::GetOwner()`, `gdcM::DictEntry::GetVM()`, and `gdcM::DictEntry::GetVR()`.

### 10.243.3.7 RemoveDictEntry()

```
bool gdcM::PrivateDict::RemoveDictEntry (
    const PrivateTag & tag ) [inline]
```

Remove entry 'tag'. Return true on success (element was found and remove). return false if element was not found.

## 10.243.4 Friends And Related Function Documentation

### 10.243.4.1 Dicts

```
friend class Dicts [friend]
```

### 10.243.4.2 operator<<

```
std::ostream& operator<< (  
    std::ostream & os,  
    const PrivateDict & val ) [friend]
```

The documentation for this class was generated from the following file:

- [gdcMDict.h](#)

## 10.244 gdcM::PrivateTag Class Reference

Class to represent a Private DICOM Data [Element](#) ([Attribute](#)) [Tag](#) (Group, [Element](#), Owner)

```
#include <gdcMPrivateTag.h>
```

Inheritance diagram for gdcM::PrivateTag:

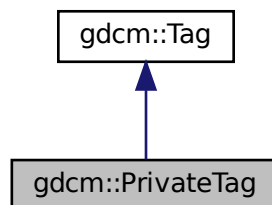

Collaboration diagram for `gdcm::PrivateTag`:

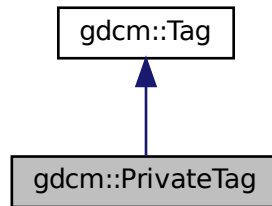

## Public Member Functions

- `PrivateTag` (`Tag` const &t, const char \*owner="")
- `PrivateTag` (uint16\_t group=0, uint16\_t element=0, const char \*owner="")
- `DataElement GetAsDataElement` () const
- const char \* `GetOwner` () const
- bool `operator<` (const `PrivateTag` &\_val) const
- bool `ReadFromCommaSeparatedString` (const char \*str)
- void `SetOwner` (const char \*owner)

## Friends

- std::ostream & `operator<<` (std::ostream &\_os, const `PrivateTag` &\_val)

### 10.244.1 Detailed Description

Class to represent a Private DICOM Data `Element` (`Attribute`) `Tag` (Group, `Element`, Owner)

#### Note

private tag have element value in: [0x10,0xff], for instance 0x0009,0x0000 is NOT a private tag

#### Examples

[ChangePrivateTags.cxx](#), [DumpADAC.cxx](#), [DumpExamCard.cxx](#), [DumpGEMSMovieGroup.cxx](#), [DumpImageHeaderInfo.cxx](#), [DumpSiemensBase64.cxx](#), [DumpToshibaDTI.cxx](#), [DumpToshibaDTI2.cxx](#), [DumpVisusChange.cxx](#), [ELSCINT1WaveToText.cxx](#), [MrProtocol.cxx](#), [PublicDict.cxx](#), [csa2img.cxx](#), [iU22tomultisc.cxx](#), [pmsct\\_rgb1.cxx](#), and [rle2img.cxx](#).

### 10.244.2 Constructor & Destructor Documentation

### 10.244.2.1 PrivateTag() [1/2]

```
gdcM::PrivateTag::PrivateTag (
    uint16_t group = 0,
    uint16_t element = 0,
    const char * owner = "" ) [inline]
```

### 10.244.2.2 PrivateTag() [2/2]

```
gdcM::PrivateTag::PrivateTag (
    Tag const & t,
    const char * owner = "" ) [inline]
```

References `gdcM::Tag::GetElement()`.

## 10.244.3 Member Function Documentation

### 10.244.3.1 GetAsDataElement()

```
DataElement gdcM::PrivateTag::GetAsDataElement ( ) const
```

### 10.244.3.2 GetOwner()

```
const char* gdcM::PrivateTag::GetOwner ( ) const [inline]
```

#### Examples

[PublicDict.cxx](#).

Referenced by `gdcM::PrivateDict::PrintXML()`.

### 10.244.3.3 operator<()

```
bool gdcM::PrivateTag::operator< (
    const PrivateTag & _val ) const
```

### 10.244.3.4 ReadFromCommaSeparatedString()

```
bool gdcM::PrivateTag::ReadFromCommaSeparatedString (
    const char * str )
```

Read [PrivateTag](#) from a string. [Element](#) number will be truncated to 8bits. Eg: "1234,5678,GDCM" is private tag: (1234,78,"GDCM")

### 10.244.3.5 SetOwner()

```
void gdcM::PrivateTag::SetOwner (
    const char * owner ) [inline]
```

## 10.244.4 Friends And Related Function Documentation

### 10.244.4.1 operator<<

```
std::ostream& operator<< (
    std::ostream & _os,
    const PrivateTag & _val ) [friend]
```

The documentation for this class was generated from the following file:

- [gdcMPrivateTag.h](#)

## 10.245 gdcM::ProgressEvent Class Reference

[ProgressEvent](#).

```
#include <gdcMProgressEvent.h>
```

Inheritance diagram for gdcM::ProgressEvent:

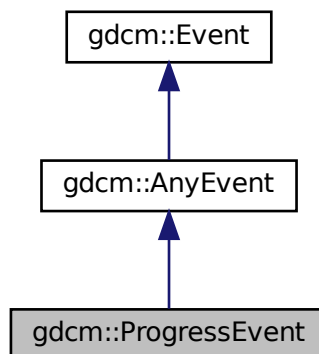

Collaboration diagram for gdcM::ProgressEvent:

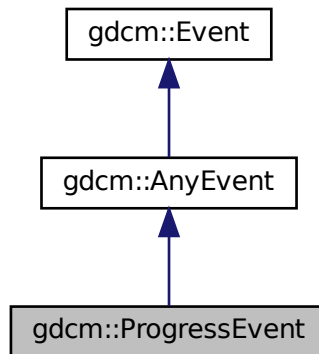

## Public Types

- typedef [ProgressEvent](#) Self
- typedef [AnyEvent](#) Superclass

## Public Member Functions

- [ProgressEvent](#) (const Self &s)
- [ProgressEvent](#) (double p=0)
- [~ProgressEvent](#) () override=default
- bool [CheckEvent](#) (const ::gdcM::Event \*e) const override
- const char \* [GetEventName](#) () const override
- double [GetProgress](#) () const
- ::gdcM::Event \* [MakeObject](#) () const override
- void [operator=](#) (const Self &)=delete
- void [SetProgress](#) (double p)

### 10.245.1 Detailed Description

[ProgressEvent](#).

Special type of event triggered during

See also

[AnyEvent](#)

## 10.245.2 Member Typedef Documentation

### 10.245.2.1 Self

```
typedef ProgressEvent gdcm::ProgressEvent::Self
```

### 10.245.2.2 Superclass

```
typedef AnyEvent gdcm::ProgressEvent::Superclass
```

## 10.245.3 Constructor & Destructor Documentation

### 10.245.3.1 ProgressEvent() [1/2]

```
gdcm::ProgressEvent::ProgressEvent (
    double p = 0 ) [inline]
```

### 10.245.3.2 ~ProgressEvent()

```
gdcm::ProgressEvent::~~ProgressEvent ( ) [override], [default]
```

### 10.245.3.3 ProgressEvent() [2/2]

```
gdcm::ProgressEvent::ProgressEvent (
    const Self & s ) [inline]
```

## 10.245.4 Member Function Documentation



#### 10.245.4.1 CheckEvent()

```
bool gdcM::ProgressEvent::CheckEvent (
    const ::gdcM::Event * e ) const [inline], [override]
```

#### 10.245.4.2 GetEventName()

```
const char* gdcM::ProgressEvent::GetEventName ( ) const [inline], [override], [virtual]
```

Return the StringName associated with the event.

Implements [gdcM::Event](#).

#### 10.245.4.3 GetProgress()

```
double gdcM::ProgressEvent::GetProgress ( ) const [inline]
```

#### 10.245.4.4 MakeObject()

```
::gdcM::Event* gdcM::ProgressEvent::MakeObject ( ) const [inline], [override], [virtual]
```

Create an [Event](#) of this type This method work as a Factory for creating events of each particular type.

Implements [gdcM::Event](#).

#### 10.245.4.5 operator=()

```
void gdcM::ProgressEvent::operator= (
    const Self & ) [delete]
```

#### 10.245.4.6 SetProgress()

```
void gdcM::ProgressEvent::SetProgress (
    double p ) [inline]
```

The documentation for this class was generated from the following file:

- [gdcMProgressEvent.h](#)

## 10.246 gdcm::PVRGCodec Class Reference

[PVRGCodec](#).

```
#include <gdcmPVRGCodec.h>
```

Inheritance diagram for gdcm::PVRGCodec:

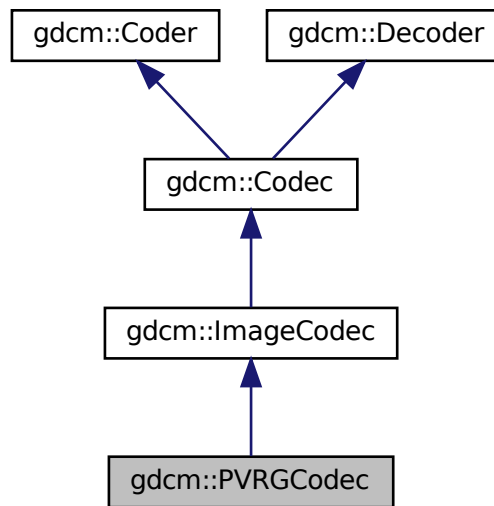

Collaboration diagram for gdcm::PVRGCodec:

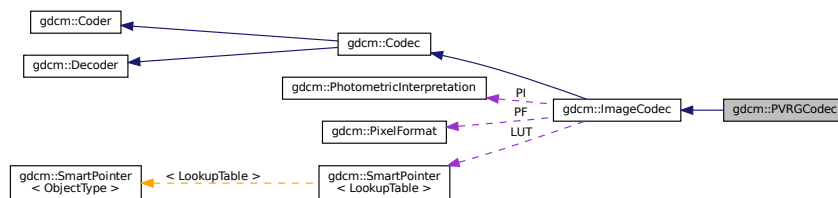

### Public Member Functions

- [PVRGCodec](#) ()
- [~PVRGCodec](#) () override
- bool [CanCode](#) ([TransferSyntax](#) const &ts) const override

- Return whether this coder support this transfer syntax (can code it)*

  - bool [CanDecode](#) ([TransferSyntax](#) const &ts) const override

*Return whether this decoder support this transfer syntax (can decode it)*

  - [ImageCodec](#) \* [Clone](#) () const override
  - bool [Code](#) ([DataElement](#) const &in, [DataElement](#) &out) override

*Code.*

  - bool [Decode](#) ([DataElement](#) const &is, [DataElement](#) &os) override

*Decode.*

  - void [SetLossyFlag](#) (bool l)

## Additional Inherited Members

### 10.246.1 Detailed Description

[PVRGCodec](#).

#### Note

pvrg is a broken implementation of the JPEG standard. It is known to have a bug in the 16bits lossless implementation of the standard.

In an ideal world, you should not need this codec at all. But to support some broken file such as:

PHILIPS\_Gyroscan-12-Jpeg\_Extended\_Process\_2\_4.dcm

we have to...

### 10.246.2 Constructor & Destructor Documentation

#### 10.246.2.1 PVRGCodec()

```
gdcm::PVRGCodec::PVRGCodec ( )
```

#### 10.246.2.2 ~PVRGCodec()

```
gdcm::PVRGCodec::~~PVRGCodec ( ) [override]
```

### 10.246.3 Member Function Documentation

### 10.246.3.1 CanCode()

```
bool gdcm::PVRGCodec::CanCode (
    TransferSyntax const & ) const [override], [virtual]
```

Return whether this coder support this transfer syntax (can code it)

Reimplemented from [gdcm::ImageCodec](#).

### 10.246.3.2 CanDecode()

```
bool gdcm::PVRGCodec::CanDecode (
    TransferSyntax const & ) const [override], [virtual]
```

Return whether this decoder support this transfer syntax (can decode it)

Reimplemented from [gdcm::ImageCodec](#).

### 10.246.3.3 Clone()

```
ImageCodec* gdcm::PVRGCodec::Clone ( ) const [override], [virtual]
```

Implements [gdcm::ImageCodec](#).

### 10.246.3.4 Code()

```
bool gdcm::PVRGCodec::Code (
    DataElement const & in_,
    DataElement & out_ ) [override], [virtual]
```

Code.

Reimplemented from [gdcm::Coder](#).

### 10.246.3.5 Decode()

```
bool gdcm::PVRGCodec::Decode (
    DataElement const & ,
    DataElement & ) [override], [virtual]
```

Decode.

Reimplemented from [gdcm::ImageCodec](#).

### 10.246.3.6 SetLossyFlag()

```
void gdcm::PVRGCodec::SetLossyFlag (
    bool l )
```

The documentation for this class was generated from the following file:

- [gdcmPVRGCodec.h](#)

## 10.247 gdcm::PythonFilter Class Reference

[PythonFilter](#) [PythonFilter](#) is the class that make gdcm2.x looks more like gdcm1 and transform the binary blob contained in a [DataElement](#) into a string, typically this is a nice feature to have for wrapped language.

```
#include <gdcmPythonFilter.h>
```

### Public Member Functions

- [PythonFilter](#) ()
- [~PythonFilter](#) ()
- [File](#) & [GetFile](#) ()
- const [File](#) & [GetFile](#) () const
- void [SetDicts](#) (const [Dicts](#) &dicts)
- void [SetFile](#) (const [File](#) &f)
- PyObject \* [ToPyObject](#) (const [Tag](#) &t) const
- void [UseDictAlways](#) (bool)

### 10.247.1 Detailed Description

[PythonFilter](#) [PythonFilter](#) is the class that make gdcm2.x looks more like gdcm1 and transform the binary blob contained in a [DataElement](#) into a string, typically this is a nice feature to have for wrapped language.

## 10.247.2 Constructor & Destructor Documentation

### 10.247.2.1 PythonFilter()

```
gdcM::PythonFilter::PythonFilter ( )
```

### 10.247.2.2 ~PythonFilter()

```
gdcM::PythonFilter::~~PythonFilter ( )
```

## 10.247.3 Member Function Documentation

### 10.247.3.1 GetFile() [1/2]

```
File& gdcM::PythonFilter::GetFile ( )
```

### 10.247.3.2 GetFile() [2/2]

```
const File& gdcM::PythonFilter::GetFile ( ) const
```

### 10.247.3.3 SetDicts()

```
void gdcM::PythonFilter::SetDicts (
    const Dicts & dicts )
```

### 10.247.3.4 SetFile()

```
void gdcM::PythonFilter::SetFile (
    const File & f )
```

### 10.247.3.5 ToPyObject()

```
PyObject* gdcm::PythonFilter::ToPyObject (
    const Tag & t ) const
```

### 10.247.3.6 UseDictAlways()

```
void gdcm::PythonFilter::UseDictAlways (
    bool ) [inline]
```

The documentation for this class was generated from the following file:

- [gdcmPythonFilter.h](#)

## 10.248 gdcm::QueryBase Class Reference

[QueryBase](#).

```
#include <gdcmQueryBase.h>
```

Inheritance diagram for gdcm::QueryBase:

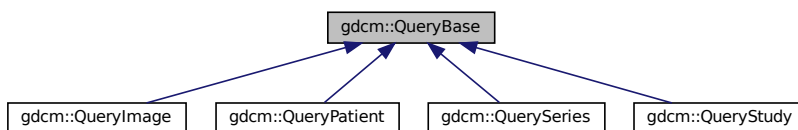

### Public Member Functions

- virtual `~QueryBase ()`=default
- `std::vector< Tag > GetAllRequiredTags (const ERootType &inRootType) const`
- `std::vector< Tag > GetAllTags (const ERootType &inRootType) const`
- virtual `std::vector< Tag > GetHierachicalSearchTags (const ERootType &inRootType) const =0`  
*Return all Unique Key for a particular Query Root type (from the same level and above).*
- virtual `const char * GetName () const =0`
- virtual `std::vector< Tag > GetOptionalTags (const ERootType &inRootType) const =0`
- virtual `DataElement GetQueryLevel () const =0`
- virtual `std::vector< Tag > GetRequiredTags (const ERootType &inRootType) const =0`
- virtual `std::vector< Tag > GetUniqueTags (const ERootType &inRootType) const =0`

## 10.248.1 Detailed Description

[QueryBase](#).

contains: the base class for constructing a query dataset for a C-FIND and a C-MOVE

There are four levels of C-FIND and C-MOVE query:

- [Patient](#)
- [Study](#)
- [Series](#)
- [Image](#)

Each one has its own required and optional tags. This class provides an interface for getting those tags. This is an interface class.

See 3.4 C 6.1 and 3.4 C 6.2 for the patient and study root query types. These sections define the tags allowed by a particular query. The caller must pass in which root type they want, patient or study. A third root type, Modality Worklist Query, isn't yet supported.

This class (or rather it's derived classes) will be held in the RootQuery types. These query types actually make the dataset, and will use this dataset to list the required, unique, and optional tags for each type of query. This design is somewhat overly complicated, but is kept so that if we ever wanted to try to guess the query type from the given tags, we could do so.

## 10.248.2 Constructor & Destructor Documentation

### 10.248.2.1 ~QueryBase()

```
virtual gdcM::QueryBase::~~QueryBase ( ) [virtual], [default]
```

## 10.248.3 Member Function Documentation

### 10.248.3.1 GetAllRequiredTags()

```
std::vector<Tag> gdcM::QueryBase::GetAllRequiredTags (
    const ERootType & inRootType ) const
```

In order to validate a query dataset we need to check that there exists at least one required (or unique) key



### 10.248.3.2 GetAllTags()

```
std::vector<Tag> gdcm::QueryBase::GetAllTags (
    const ERootType & inRootType ) const
```

In order to validate a query dataset, just check for the presence of a tag, not it's requirement level in the spec

### 10.248.3.3 GetHierachicalSearchTags()

```
virtual std::vector<Tag> gdcm::QueryBase::GetHierachicalSearchTags (
    const ERootType & inRootType ) const [pure virtual]
```

Return all Unique Key for a particular Query Root type (from the same level and above).

Implemented in [gdcm::QueryStudy](#), [gdcm::QuerySeries](#), [gdcm::QueryPatient](#), and [gdcm::QueryImage](#).

### 10.248.3.4 GetName()

```
virtual const char* gdcm::QueryBase::GetName ( ) const [pure virtual]
```

Implemented in [gdcm::QueryStudy](#), [gdcm::QuerySeries](#), [gdcm::QueryPatient](#), and [gdcm::QueryImage](#).

### 10.248.3.5 GetOptionalTags()

```
virtual std::vector<Tag> gdcm::QueryBase::GetOptionalTags (
    const ERootType & inRootType ) const [pure virtual]
```

Implemented in [gdcm::QueryStudy](#), [gdcm::QuerySeries](#), [gdcm::QueryPatient](#), and [gdcm::QueryImage](#).

### 10.248.3.6 GetQueryLevel()

```
virtual DataElement gdcm::QueryBase::GetQueryLevel ( ) const [pure virtual]
```

Implemented in [gdcm::QueryStudy](#), [gdcm::QuerySeries](#), [gdcm::QueryPatient](#), and [gdcm::QueryImage](#).

### 10.248.3.7 GetRequiredTags()

```
virtual std::vector<Tag> gdcm::QueryBase::GetRequiredTags (
    const ERootType & inRootType ) const [pure virtual]
```

Implemented in [gdcm::QueryStudy](#), [gdcm::QuerySeries](#), [gdcm::QueryPatient](#), and [gdcm::QueryImage](#).

### 10.248.3.8 GetUniqueTags()

```
virtual std::vector<Tag> gdcm::QueryBase::GetUniqueTags (
    const ERootType & inRootType ) const [pure virtual]
```

Implemented in [gdcm::QueryStudy](#), [gdcm::QuerySeries](#), [gdcm::QueryPatient](#), and [gdcm::QueryImage](#).

The documentation for this class was generated from the following file:

- [gdcmQueryBase.h](#)

## 10.249 gdcm::QueryFactory Class Reference

QueryFactory.h.

```
#include <gdcmQueryFactory.h>
```

### Static Public Member Functions

- static [ECharSet](#) [GetCharacterFromCurrentLocale](#) ()
- static void [ListCharSets](#) (std::ostream &os)
  - List all possible CharSet.*
- static [DataElement](#) [ProduceCharacterSetDataElement](#) (const std::vector< [ECharSet](#) > &inCharSetType)
- static [BaseQuery](#) \* [ProduceQuery](#) (const std::string &sopInstanceUID, [ENQueryType](#) inQueryType)
- static [BaseRootQuery](#) \* [ProduceQuery](#) ([ERootType](#) inRootType, [EQueryType](#) inQueryType, [EQueryLevel](#) inQueryLevel)

### 10.249.1 Detailed Description

QueryFactory.h.

#### Note

contains: a class to produce a query based off of user-entered information

Essentially, this class is used to construct a query based off of user input (typically from the command line; if in code directly, the query itself could just be instantiated)

In theory, could also be used as the interface to validate incoming datasets as belonging to a particular query style

## 10.249.2 Member Function Documentation

### 10.249.2.1 GetCharacterFromCurrentLocale()

```
static ECharSet gdcm::QueryFactory::GetCharacterFromCurrentLocale ( ) [static]
```

This function will return the corresponding ECharSet associated with the current locale of the running system (based on the value of locale() ).

### 10.249.2.2 ListCharSets()

```
static void gdcm::QueryFactory::ListCharSets (
    std::ostream & os ) [static]
```

List all possible CharSet.

### 10.249.2.3 ProduceCharacterSetDataElement()

```
static DataElement gdcm::QueryFactory::ProduceCharacterSetDataElement (
    const std::vector< ECharSet > & inCharSetType ) [static]
```

This function will produce the appropriate dataelement given a list of charsets. The first charset will be used directly, while the second and subsequent will be prepended with "ISO2022 ". Redundant character sets are not permitted, so if they are encountered, they will just be skipped. if UTF8 or GB18030 is used, no subsequent character sets will be used if the vector passed in is empty, then the dataelement that's passed out will be empty and Latin1 is the presumed encoding

### 10.249.2.4 ProduceQuery() [1/2]

```
static BaseQuery* gdcm::QueryFactory::ProduceQuery (
    const std::string & sopInstanceUID,
    ENQueryType inQueryType ) [static]
```

### 10.249.2.5 ProduceQuery() [2/2]

```
static BaseRootQuery* gdcM::QueryFactory::ProduceQuery (
    ERootType inRootType,
    EQueryType inQueryType,
    EQueryLevel inQueryLevel ) [static]
```

this function will produce a query (basically, a wrapper to a dataset that can validate whether or not the query is a valid cfind/cmove query) and the level of the query (patient, study, series, image). If the user provides an invalid instantiation (ie, study root type, query level of patient), then the result is NULL.

The documentation for this class was generated from the following file:

- [gdcMQueryFactory.h](#)

## 10.250 gdcM::QueryImage Class Reference

[QueryImage](#).

```
#include <gdcMQueryImage.h>
```

Inheritance diagram for gdcM::QueryImage:

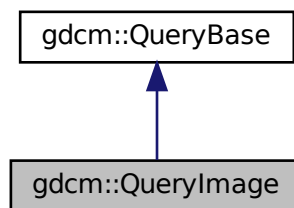

Collaboration diagram for gdcM::QueryImage:

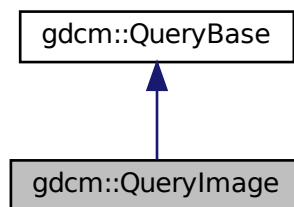

## Public Member Functions

- `std::vector< Tag > GetHierarchicalSearchTags` (const `ERootType` &`inRootType`) const override  
*Return all Unique Key for a particular Query Root type (from the same level and above).*
- `const char * GetName` () const override
- `std::vector< Tag > GetOptionalTags` (const `ERootType` &`inRootType`) const override
- `DataElement GetQueryLevel` () const override
- `std::vector< Tag > GetRequiredTags` (const `ERootType` &`inRootType`) const override
- `std::vector< Tag > GetUniqueTags` (const `ERootType` &`inRootType`) const override

### 10.250.1 Detailed Description

[QueryImage](#).

contains: class to construct an image-based query for C-FIND and C-MOVE

### 10.250.2 Member Function Documentation

#### 10.250.2.1 GetHierarchicalSearchTags()

```
std::vector<Tag> gdcm::QueryImage::GetHierarchicalSearchTags (
    const ERootType & inRootType ) const [override], [virtual]
```

Return all Unique Key for a particular Query Root type (from the same level and above).

Implements [gdcm::QueryBase](#).

#### 10.250.2.2 GetName()

```
const char* gdcm::QueryImage::GetName ( ) const [override], [virtual]
```

Implements [gdcm::QueryBase](#).

#### 10.250.2.3 GetOptionalTags()

```
std::vector<Tag> gdcm::QueryImage::GetOptionalTags (
    const ERootType & inRootType ) const [override], [virtual]
```

Implements [gdcm::QueryBase](#).

#### 10.250.2.4 GetQueryLevel()

```
DataElement gdcM::QueryImage::GetQueryLevel ( ) const [override], [virtual]
```

Implements [gdcM::QueryBase](#).

#### 10.250.2.5 GetRequiredTags()

```
std::vector<Tag> gdcM::QueryImage::GetRequiredTags (
    const ERootType & inRootType ) const [override], [virtual]
```

Implements [gdcM::QueryBase](#).

#### 10.250.2.6 GetUniqueTags()

```
std::vector<Tag> gdcM::QueryImage::GetUniqueTags (
    const ERootType & inRootType ) const [override], [virtual]
```

Implements [gdcM::QueryBase](#).

The documentation for this class was generated from the following file:

- [gdcMQueryImage.h](#)

## 10.251 gdcM::QueryPatient Class Reference

[QueryPatient](#).

```
#include <gdcMQueryPatient.h>
```

Inheritance diagram for [gdcM::QueryPatient](#):

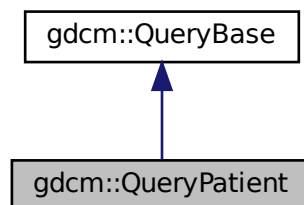

Collaboration diagram for gdcm::QueryPatient:

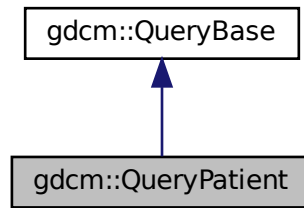

## Public Member Functions

- `std::vector< Tag > GetHierachicalSearchTags` (const `ERootType` &`inRootType`) const override  
*Return all Unique Key for a particular Query Root type (from the same level and above).*
- `const char * GetName` () const override
- `std::vector< Tag > GetOptionalTags` (const `ERootType` &`inRootType`) const override
- `DataElement GetQueryLevel` () const override
- `std::vector< Tag > GetRequiredTags` (const `ERootType` &`inRootType`) const override
- `std::vector< Tag > GetUniqueTags` (const `ERootType` &`inRootType`) const override

### 10.251.1 Detailed Description

[QueryPatient](#).

contains: class to construct a patient-based query for c-find and c-move

### 10.251.2 Member Function Documentation

#### 10.251.2.1 GetHierachicalSearchTags()

```
std::vector<Tag> gdcm::QueryPatient::GetHierachicalSearchTags (  
    const ERootType & inRootType ) const [override], [virtual]
```

Return all Unique Key for a particular Query Root type (from the same level and above).

Implements [gdcm::QueryBase](#).

### 10.251.2.2 GetName()

```
const char* gdcm::QueryPatient::GetName ( ) const [override], [virtual]
```

Implements [gdcm::QueryBase](#).

### 10.251.2.3 GetOptionalTags()

```
std::vector<Tag> gdcm::QueryPatient::GetOptionalTags (
    const ERootType & inRootType ) const [override], [virtual]
```

Implements [gdcm::QueryBase](#).

### 10.251.2.4 GetQueryLevel()

```
DataElement gdcm::QueryPatient::GetQueryLevel ( ) const [override], [virtual]
```

Implements [gdcm::QueryBase](#).

### 10.251.2.5 GetRequiredTags()

```
std::vector<Tag> gdcm::QueryPatient::GetRequiredTags (
    const ERootType & inRootType ) const [override], [virtual]
```

Implements [gdcm::QueryBase](#).

### 10.251.2.6 GetUniqueTags()

```
std::vector<Tag> gdcm::QueryPatient::GetUniqueTags (
    const ERootType & inRootType ) const [override], [virtual]
```

Implements [gdcm::QueryBase](#).

The documentation for this class was generated from the following file:

- [gdcmQueryPatient.h](#)



## 10.252 gdcm::QuerySeries Class Reference

[QuerySeries](#).

```
#include <gdcmQuerySeries.h>
```

Inheritance diagram for gdcm::QuerySeries:

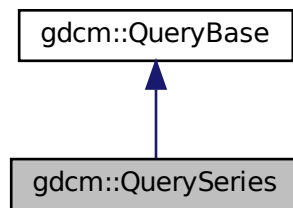

Collaboration diagram for gdcm::QuerySeries:

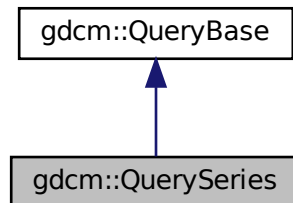

### Public Member Functions

- `std::vector< Tag > GetHierachicalSearchTags` (const `ERootType` &inRootType) const override  
*Return all Unique Key for a particular Query Root type (from the same level and above).*
- `const char * GetName` () const override
- `std::vector< Tag > GetOptionalTags` (const `ERootType` &inRootType) const override
- `DataElement GetQueryLevel` () const override
- `std::vector< Tag > GetRequiredTags` (const `ERootType` &inRootType) const override
- `std::vector< Tag > GetUniqueTags` (const `ERootType` &inRootType) const override

## 10.252.1 Detailed Description

[QuerySeries](#).

contains: class to construct a series-based query for c-find and c-move

## 10.252.2 Member Function Documentation

### 10.252.2.1 GetHierarchicalSearchTags()

```
std::vector<Tag> gdcM::QuerySeries::GetHierarchicalSearchTags (  
    const ERootType & inRootType ) const [override], [virtual]
```

Return all Unique Key for a particular Query Root type (from the same level and above).

Implements [gdcM::QueryBase](#).

### 10.252.2.2 GetName()

```
const char* gdcM::QuerySeries::GetName ( ) const [override], [virtual]
```

Implements [gdcM::QueryBase](#).

### 10.252.2.3 GetOptionalTags()

```
std::vector<Tag> gdcM::QuerySeries::GetOptionalTags (  
    const ERootType & inRootType ) const [override], [virtual]
```

Implements [gdcM::QueryBase](#).

### 10.252.2.4 GetQueryLevel()

```
DataElement gdcM::QuerySeries::GetQueryLevel ( ) const [override], [virtual]
```

Implements [gdcM::QueryBase](#).

### 10.252.2.5 GetRequiredTags()

```
std::vector<Tag> gdcM::QuerySeries::GetRequiredTags (
    const ERootType & inRootType ) const [override], [virtual]
```

Implements [gdcM::QueryBase](#).

### 10.252.2.6 GetUniqueTags()

```
std::vector<Tag> gdcM::QuerySeries::GetUniqueTags (
    const ERootType & inRootType ) const [override], [virtual]
```

Implements [gdcM::QueryBase](#).

The documentation for this class was generated from the following file:

- [gdcMQuerySeries.h](#)

## 10.253 gdcM::QueryStudy Class Reference

QueryStudy.h.

```
#include <gdcMQueryStudy.h>
```

Inheritance diagram for gdcM::QueryStudy:

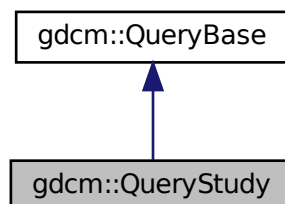

Collaboration diagram for `gdcm::QueryStudy`:

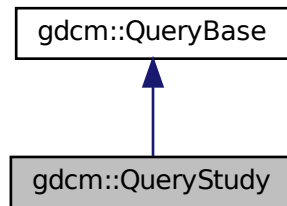

## Public Member Functions

- `std::vector< Tag > GetHierarchicalSearchTags` (const `ERootType` &`inRootType`) const override  
*Return all Unique Key for a particular Query Root type (from the same level and above).*
- `const char * GetName` () const override
- `std::vector< Tag > GetOptionalTags` (const `ERootType` &`inRootType`) const override
- `DataElement GetQueryLevel` () const override
- `std::vector< Tag > GetRequiredTags` (const `ERootType` &`inRootType`) const override
- `std::vector< Tag > GetUniqueTags` (const `ERootType` &`inRootType`) const override

### 10.253.1 Detailed Description

`QueryStudy.h`.

contains: class to construct a study-based query for C-FIND and C-MOVE

### 10.253.2 Member Function Documentation

#### 10.253.2.1 GetHierarchicalSearchTags()

```
std::vector<Tag> gdcm::QueryStudy::GetHierarchicalSearchTags (
    const ERootType & inRootType ) const [override], [virtual]
```

Return all Unique Key for a particular Query Root type (from the same level and above).

Implements [gdcm::QueryBase](#).

### 10.253.2.2 GetName()

```
const char* gdcM::QueryStudy::GetName ( ) const [override], [virtual]
```

Implements [gdcM::QueryBase](#).

### 10.253.2.3 GetOptionalTags()

```
std::vector<Tag> gdcM::QueryStudy::GetOptionalTags (
    const ERootType & inRootType ) const [override], [virtual]
```

Implements [gdcM::QueryBase](#).

### 10.253.2.4 GetQueryLevel()

```
DataElement gdcM::QueryStudy::GetQueryLevel ( ) const [override], [virtual]
```

Implements [gdcM::QueryBase](#).

### 10.253.2.5 GetRequiredTags()

```
std::vector<Tag> gdcM::QueryStudy::GetRequiredTags (
    const ERootType & inRootType ) const [override], [virtual]
```

Implements [gdcM::QueryBase](#).

### 10.253.2.6 GetUniqueTags()

```
std::vector<Tag> gdcM::QueryStudy::GetUniqueTags (
    const ERootType & inRootType ) const [override], [virtual]
```

Implements [gdcM::QueryBase](#).

The documentation for this class was generated from the following file:

- [gdcMQueryStudy.h](#)

## 10.254 gdcm::RAWCodec Class Reference

[RAWCodec](#) class.

```
#include <gdcmRAWCodec.h>
```

Inheritance diagram for gdcm::RAWCodec:

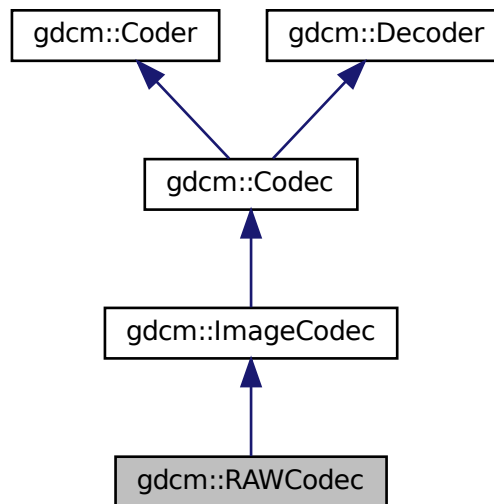

Collaboration diagram for gdcm::RAWCodec:

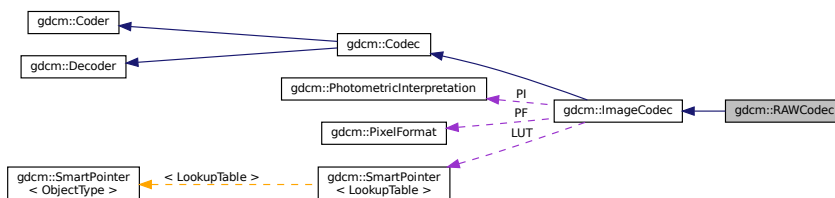

### Public Member Functions

- [RAWCodec](#) ()
- [~RAWCodec](#) () override
- bool [CanCode](#) ([TransferSyntax](#) const &ts) const override

*Return whether this coder support this transfer syntax (can code it)*

- bool [CanDecode](#) ([TransferSyntax](#) const &ts) const override

*Return whether this decoder support this transfer syntax (can decode it)*

- [ImageCodec](#) \* [Clone](#) () const override
- bool [Code](#) ([DataElement](#) const &in, [DataElement](#) &out) override

*Code.*

- bool [Decode](#) ([DataElement](#) const &is, [DataElement](#) &os) override

*Decode.*

- bool [DecodeBytes](#) (const char \*inBytes, size\_t inBufferLength, char \*outBytes, size\_t inOutBufferLength)
- bool [GetHeaderInfo](#) (std::istream &is, [TransferSyntax](#) &ts) override

## Protected Member Functions

- bool [DecodeByStreams](#) (std::istream &is, std::ostream &os) override

## Additional Inherited Members

### 10.254.1 Detailed Description

[RAWCodec](#) class.

### 10.254.2 Constructor & Destructor Documentation

#### 10.254.2.1 RAWCodec()

```
gdcm::RAWCodec::RAWCodec ( )
```

#### 10.254.2.2 ~RAWCodec()

```
gdcm::RAWCodec::~~RAWCodec ( ) [override]
```

### 10.254.3 Member Function Documentation

### 10.254.3.1 CanCode()

```
bool gdcm::RAWCodec::CanCode (
    TransferSyntax const & ) const [override], [virtual]
```

Return whether this coder support this transfer syntax (can code it)

Reimplemented from [gdcm::ImageCodec](#).

### 10.254.3.2 CanDecode()

```
bool gdcm::RAWCodec::CanDecode (
    TransferSyntax const & ) const [override], [virtual]
```

Return whether this decoder support this transfer syntax (can decode it)

Reimplemented from [gdcm::ImageCodec](#).

### 10.254.3.3 Clone()

```
ImageCodec* gdcm::RAWCodec::Clone ( ) const [override], [virtual]
```

Implements [gdcm::ImageCodec](#).

### 10.254.3.4 Code()

```
bool gdcm::RAWCodec::Code (
    DataElement const & in_,
    DataElement & out_ ) [override], [virtual]
```

Code.

Reimplemented from [gdcm::Coder](#).



### 10.254.3.5 Decode()

```
bool gdcm::RAWCodec::Decode (
    DataElement const & ,
    DataElement & ) [override], [virtual]
```

Decode.

Reimplemented from [gdcm::ImageCodec](#).

### 10.254.3.6 DecodeByStreams()

```
bool gdcm::RAWCodec::DecodeByStreams (
    std::istream & is,
    std::ostream & os ) [override], [protected], [virtual]
```

Reimplemented from [gdcm::ImageCodec](#).

### 10.254.3.7 DecodeBytes()

```
bool gdcm::RAWCodec::DecodeBytes (
    const char * inBytes,
    size_t inBufferLength,
    char * outBytes,
    size_t inOutBufferLength )
```

Used by the ImageStreamReader– converts a read in buffer into one with the proper encodings.

### 10.254.3.8 GetHeaderInfo()

```
bool gdcm::RAWCodec::GetHeaderInfo (
    std::istream & is,
    TransferSyntax & ts ) [override], [virtual]
```

Reimplemented from [gdcm::ImageCodec](#).

The documentation for this class was generated from the following file:

- [gdcmRAWCodec.h](#)

## 10.255 gdcM::Reader Class Reference

[Reader](#) ala DOM (Document [Object](#) Model)

```
#include <gdcMReader.h>
```

Inheritance diagram for gdcM::Reader:

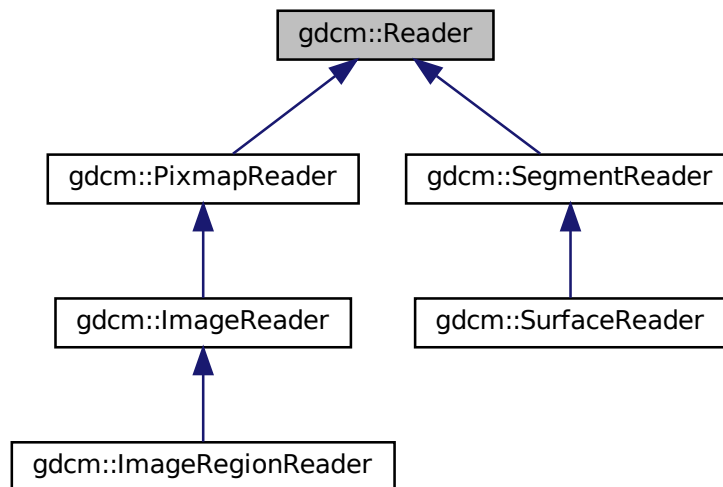

Collaboration diagram for gdcm::Reader:

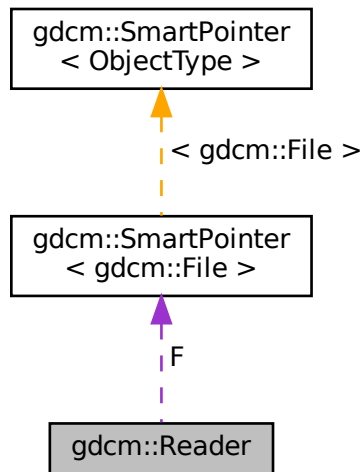

## Public Member Functions

- [Reader](#) ()
- virtual [~Reader](#) ()
- bool [CanRead](#) () const
- [File](#) & [GetFile](#) ()
  - Set/Get File.*
- const [File](#) & [GetFile](#) () const
  - Set/Get File.*
- size\_t [GetStreamCurrentPosition](#) () const
- virtual bool [Read](#) ()
  - Main function to read a file.*
- bool [ReadSelectedPrivateTags](#) (std::set< [PrivateTag](#) > const &ptags, bool readvalues=true)
  - Will only read the specified selected private tags.*
- bool [ReadSelectedTags](#) (std::set< [Tag](#) > const &tags, bool readvalues=true)
  - Will only read the specified selected tags.*
- bool [ReadUpToTag](#) (const [Tag](#) &tag, std::set< [Tag](#) > const &skiptags=std::set< [Tag](#) >())
- void [SetFile](#) ([File](#) &file)
  - Set/Get File.*
- void [SetFileName](#) (const char \*filename\_native)
- void [SetStream](#) (std::istream &input\_stream)
  - Set the open-ed stream directly.*

## Protected Member Functions

- `std::istream * GetStreamPtr () const`
- `bool ReadDataSet ()`
- `bool ReadMetaInformation ()`
- `bool ReadPreamble ()`

## Protected Attributes

- `SmartPointer< File > F`

## Friends

- class `StreamImageReader`

## 10.255.1 Detailed Description

`Reader` ala DOM (Document [Object](#) Model)

This class is a non-validating reader, it will only performs well- formedness check only, and to some extent catch known error (non well-formed document).

Detailed description here

A `DataSet` DOES NOT contains group 0x0002 (see [FileMetaInformation](#))

This is really a `DataSet` reader. This will not make sure the dataset conform to any `IOD` at all. This is a completely different step. The reasoning was that user could control the `IOD` there lib would handle and thus we would not be able to read a `DataSet` if the `IOD` was not found Instead we separate the reading from the validation.

### Note

From GDCM1.x. Users will realize that one feature is missing from this DOM implementation. In GDCM 1.x user used to be able to control the size of the `Value` to be read. By default it was 0xffff. The main author of GDCM2 thought this was too dangerous and harmful and therefore this feature did not make it into GDCM2

### Warning

GDCM will not produce warning for unordered (non-alphabetical order).

### See also

[Writer FileMetaInformation DataSet File](#)

### Examples

[ChangePrivateTags.cxx](#), [ChangeSequenceUltrasound.cxx](#), [ClinicalTrialAnnotate.cxx](#), [CreateFakeRTDOSE.cxx](#), [DeriveSeries.cxx](#), [DiffFile.cxx](#), [DumpADAC.cxx](#), [DumpExamCard.cxx](#), [DumpGEMSMovieGroup.cxx](#), [DumpImageHeaderInfo.cxx](#), [DumpPhilipsECHO.cxx](#), [DumpSiemensBase64.cxx](#), [DumpToshibaDTI.cxx](#), [DumpToshibaDTI2.cxx](#), [DumpVisusChange.cxx](#), [DuplicatePCDE.cxx](#), [ELSCINT1WaveToText.cxx](#), [ExtractEncryptedContent.cxx](#), [FixBrokenJ2K.cxx](#), [FixOrientation.cxx](#), [GenLongSeqs.cxx](#), [GenSeqs.cxx](#), [GetSequenceUltrasound.cxx](#), [GetSubSequenceData.cxx](#), [HelloWorld.cxx](#), [LargeVRDSExplicit.cxx](#), [MakeTemplate.cxx](#), [PatchFile.cxx](#), [QIDO-RS.cxx](#), [ReadAndDumpDICOmdir.cxx](#), [ReadAndDumpDICOmdir2.cxx](#), [ReadAndPrintAttributes.cxx](#), [ReadExplicitLengthSQIVR.cxx](#), [ReadUTF8QtDir.cxx](#), [TestReader.cxx](#), [csa2img.cxx](#), [gdcmrtonplan.cxx](#), [gdcmrtpplan.cxx](#), [iU22tomultisc.cxx](#), [pmsct\\_rgb1.cxx](#), and [rle2img.cxx](#).

## 10.255.2 Constructor & Destructor Documentation

### 10.255.2.1 Reader()

```
gdcM::Reader::Reader ( )
```

### 10.255.2.2 ~Reader()

```
virtual gdcM::Reader::~Reader ( ) [virtual]
```

## 10.255.3 Member Function Documentation

### 10.255.3.1 CanRead()

```
bool gdcM::Reader::CanRead ( ) const
```

Test whether this is a DICOM file

#### Warning

need to call either `SetFileName` or `SetStream` first

#### Examples

[ReadUTF8QtDir.cxx](#).

### 10.255.3.2 GetFile() [1/2]

```
File& gdcM::Reader::GetFile ( ) [inline]
```

Set/Get [File](#).

### 10.255.3.3 GetFile() [2/2]

```
const File& gdcm::Reader::GetFile ( ) const [inline]
```

Set/Get File.

#### Examples

[ChangePrivateTags.cxx](#), [ChangeSequenceUltrasound.cxx](#), [ClinicalTrialAnnotate.cxx](#), [CompressImage.cxx](#), [CreateFakeRTDOSE.cxx](#), [DeriveSeries.cxx](#), [DiffFile.cxx](#), [DumpADAC.cxx](#), [DumpExamCard.cxx](#), [DumpGEMSMovieGroup.cxx](#), [DumpImageHeaderInfo.cxx](#), [DumpPhilipsECHO.cxx](#), [DumpSiemensBase64.cxx](#), [DumpToshibaDTI.cxx](#), [DumpToshibaDTI2.cxx](#), [DumpVisusChange.cxx](#), [DuplicatePCDE.cxx](#), [ELSCINT1WaveToText.cxx](#), [ExtractEncryptedContent.cxx](#), [ExtractIconFromFile.cxx](#), [FixBrokenJ2K.cxx](#), [FixJAIBugJPEGLS.cxx](#), [FixOrientation.cxx](#), [GenLongSeqs.cxx](#), [GenSeqs.cxx](#), [GetJPEGSamplePrecision.cxx](#), [GetSequenceUltrasound.cxx](#), [GetSubSequenceData.cxx](#), [HelloWorld.cxx](#), [LargeVRDSExplicit.cxx](#), [MakeTemplate.cxx](#), [MergeTwoFiles.cxx](#), [MrProtocol.cxx](#), [PatchFile.cxx](#), [QIDO-RS.cxx](#), [ReadAndDumpDICOMDIR.cxx](#), [ReadAndDumpDICOMDIR2.cxx](#), [ReadAndPrintAttributes.cxx](#), [ReadExplicitLengthSQIVR.cxx](#), [TestReader.cxx](#), [csa2img.cxx](#), [gdcmrtionplan.cxx](#), [gdcmrtplan.cxx](#), [iU22tomultisc.cxx](#), [pmsct\\_rgb1.cxx](#), and [rle2img.cxx](#).

### 10.255.3.4 GetStreamCurrentPosition()

```
size_t gdcm::Reader::GetStreamCurrentPosition ( ) const
```

For wrapped language. return type is compatible with [System::FileSize](#) return type Use native `std::streampos / std::streamoff` directly from the stream from C++

### 10.255.3.5 GetStreamPtr()

```
std::istream* gdcm::Reader::GetStreamPtr ( ) const [inline], [protected]
```

### 10.255.3.6 Read()

```
virtual bool gdcm::Reader::Read ( ) [virtual]
```

Main function to read a file.

Reimplemented in [gdcm::SurfaceReader](#), [gdcm::SegmentReader](#), [gdcm::PixmapReader](#), [gdcm::ImageRegionReader](#), and [gdcm::ImageReader](#).

#### Examples

[ChangePrivateTags.cxx](#), [ChangeSequenceUltrasound.cxx](#), [ClinicalTrialAnnotate.cxx](#), [CreateFakeRTDOSE.cxx](#), [DeriveSeries.cxx](#), [DiffFile.cxx](#), [DumpADAC.cxx](#), [DumpExamCard.cxx](#), [DumpGEMSMovieGroup.cxx](#), [DumpImageHeaderInfo.cxx](#), [DumpPhilipsECHO.cxx](#), [DumpSiemensBase64.cxx](#), [DumpToshibaDTI.cxx](#), [DumpToshibaDTI2.cxx](#), [DuplicatePCDE.cxx](#), [ELSCINT1WaveToText.cxx](#), [ExtractEncryptedContent.cxx](#), [FixBrokenJ2K.cxx](#), [FixOrientation.cxx](#), [GenLongSeqs.cxx](#), [GenSeqs.cxx](#), [GetSequenceUltrasound.cxx](#), [GetSubSequenceData.cxx](#), [HelloWorld.cxx](#), [LargeVRDSExplicit.cxx](#), [MakeTemplate.cxx](#), [PatchFile.cxx](#), [QIDO-RS.cxx](#), [ReadAndDumpDICOMDIR.cxx](#), [ReadAndDumpDICOMDIR2.cxx](#), [ReadAndPrintAttributes.cxx](#), [ReadExplicitLengthSQIVR.cxx](#), [TestReader.cxx](#), [csa2img.cxx](#), [gdcmrtionplan.cxx](#), [gdcmrtplan.cxx](#), [iU22tomultisc.cxx](#), [pmsct\\_rgb1.cxx](#), and [rle2img.cxx](#).

### 10.255.3.7 ReadDataSet()

```
bool gdcm::Reader::ReadDataSet ( ) [protected]
```

### 10.255.3.8 ReadMetaInformation()

```
bool gdcm::Reader::ReadMetaInformation ( ) [protected]
```

### 10.255.3.9 ReadPreamble()

```
bool gdcm::Reader::ReadPreamble ( ) [protected]
```

### 10.255.3.10 ReadSelectedPrivateTags()

```
bool gdcm::Reader::ReadSelectedPrivateTags (
    std::set< PrivateTag > const & ptags,
    bool readvalues = true )
```

Will only read the specified selected private tags.

### 10.255.3.11 ReadSelectedTags()

```
bool gdcm::Reader::ReadSelectedTags (
    std::set< Tag > const & tags,
    bool readvalues = true )
```

Will only read the specified selected tags.

### 10.255.3.12 ReadUpToTag()

```
bool gdcm::Reader::ReadUpToTag (
    const Tag & tag,
    std::set< Tag > const & skiptags = std::set< Tag >() )
```

Will read only up to [Tag](#)

## Parameters

<i>tag</i>	and skipping any tag specified in
<i>skiptags</i>	

## Examples

[DumpVisusChange.cxx](#).

**10.255.3.13 SetFile()**

```
void gdcmm::Reader::SetFile (
    File & file ) [inline]
```

Set/Get [File](#).

**10.255.3.14 SetFileName()**

```
void gdcmm::Reader::SetFileName (
    const char * filename_native )
```

Set the filename to open. This will create a `std::ifstream` internally See [SetStream](#) if you are dealing with different `std::istream` object

## Examples

[BasicImageAnonymizer.cs](#), [ChangePrivateTags.cxx](#), [ChangeSequenceUltrasound.cxx](#), [CheckBigEndianBug.cxx](#), [ClinicalTrialAnnotate.cxx](#), [CompressImage.cxx](#), [ConvertToQImage.cxx](#), [CreateFakeRTDOSE.cxx](#), [DeriveSeries.cxx](#), [DiffFile.cxx](#), [DumpADAC.cxx](#), [DumpCSA.cs](#), [DumpExamCard.cxx](#), [DumpGEMSMovieGroup.cxx](#), [DumpImageHeaderInfo.cxx](#), [DumpPhilipsECHO.cxx](#), [DumpSiemensBase64.cxx](#), [DumpToshibaDTI.cxx](#), [DumpToshibaDTI2.cxx](#), [DumpVisusChange.cxx](#), [DuplicatePCDE.cxx](#), [ELSCINT1WaveToText.cxx](#), [ExtractEncryptedContent.cxx](#), [ExtractIconFromFile.cxx](#), [ExtractImageRegion.cs](#), [ExtractImageRegionWithLUT.cs](#), [FixBrokenJ2K.cxx](#), [FixJAIBugJPEGLS.cxx](#), [FixOrientation.cxx](#), [GenLongSeqs.cxx](#), [GenSeqs.cxx](#), [GetJPEGSamplePrecision.cxx](#), [GetSequenceUltrasound.cxx](#), [GetSubSequenceData.cxx](#), [HelloVizWorld.cxx](#), [HelloWorld.cxx](#), [LargeVRDSExplicit.cxx](#), [MakeTemplate.cxx](#), [MergeTwoFiles.cxx](#), [MrProtocol.cxx](#), [NewSequence.cs](#), [PatchFile.cxx](#), [PrintLUT.cxx](#), [QIDO-RS.cxx](#), [ReadAndDumpDICOMDIR.cxx](#), [ReadAndDumpDICOMDIR2.cxx](#), [ReadAndPrintAttributes.cxx](#), [ReadExplicitLengthSQIVR.cxx](#), [ReadMultiTimesException.cxx](#), [ReadUTF8QtDir.cxx](#), [SimplePrintPatientName.cs](#), [TemplateEmptyImage.cxx](#), [TestReader.cxx](#), [csa2img.cxx](#), [gdcmmrionplan.cxx](#), [gdcmmrplan.cxx](#), [iU22tomultisc.cxx](#), [pmsct\\_rgb1.cxx](#), [rle2img.cxx](#), and [threadgdcmm.cxx](#).



### 10.255.3.15 SetStream()

```
void gdcM::Reader::SetStream (
    std::istream & input_stream ) [inline]
```

Set the open-ed stream directly.

#### Examples

[ReadUTF8QtDir.cxx](#).

## 10.255.4 Friends And Related Function Documentation

### 10.255.4.1 StreamImageReader

```
friend class StreamImageReader [friend]
```

## 10.255.5 Member Data Documentation

### 10.255.5.1 F

```
SmartPointer<File> gdcM::Reader::F [protected]
```

The documentation for this class was generated from the following file:

- [gdcMReader.h](#)

## 10.256 gdcmm::RealWorldValueMappingContent Struct Reference

```
#include <gdcmmImageHelper.h>
```

Collaboration diagram for gdcmm::RealWorldValueMappingContent:

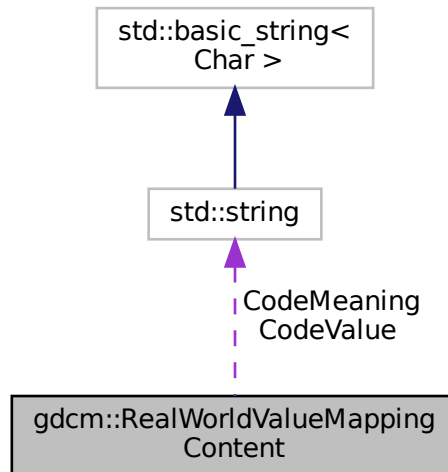

### Public Attributes

- std::string [CodeMeaning](#)
- std::string [CodeValue](#)
- double [RealWorldValueIntercept](#)
- double [RealWorldValueSlope](#)

### 10.256.1 Member Data Documentation

#### 10.256.1.1 CodeMeaning

```
std::string gdcmm::RealWorldValueMappingContent::CodeMeaning
```

### 10.256.1.2 CodeValue

```
std::string gdcm::RealWorldValueMappingContent::CodeValue
```

### 10.256.1.3 RealWorldValueIntercept

```
double gdcm::RealWorldValueMappingContent::RealWorldValueIntercept
```

### 10.256.1.4 RealWorldValueSlope

```
double gdcm::RealWorldValueMappingContent::RealWorldValueSlope
```

The documentation for this struct was generated from the following file:

- [gdcmImageHelper.h](#)

## 10.257 gdcm::Region Class Reference

Class for manipulation region.

```
#include <gdcmRegion.h>
```

Inheritance diagram for gdcm::Region:

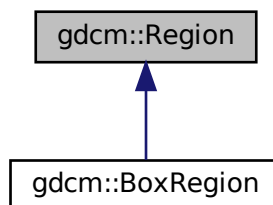

## Public Member Functions

- [Region](#) ()
- virtual [~Region](#) ()
- virtual `size_t` [Area](#) () const =0  
*compute the area*
- virtual `Region *` [Clone](#) () const =0
- virtual `BoxRegion` [ComputeBoundingBox](#) ()=0  
*Return the Axis-Aligned minimum bounding box for all regions.*
- virtual `bool` [Empty](#) () const =0  
*return whether this domain is empty:*
- virtual `bool` [IsValid](#) () const =0  
*return whether this is valid domain*
- virtual `void` [Print](#) (std::ostream &os=std::cout) const  
*Print.*

### 10.257.1 Detailed Description

Class for manipulation region.

### 10.257.2 Constructor & Destructor Documentation

#### 10.257.2.1 Region()

```
gdcM::Region::Region ( )
```

#### 10.257.2.2 ~Region()

```
virtual gdcM::Region::~~Region ( ) [virtual]
```

### 10.257.3 Member Function Documentation

### 10.257.3.1 Area()

```
virtual size_t gdcm::Region::Area ( ) const [pure virtual]
```

compute the area

Implemented in [gdcm::BoxRegion](#).

### 10.257.3.2 Clone()

```
virtual Region* gdcm::Region::Clone ( ) const [pure virtual]
```

Implemented in [gdcm::BoxRegion](#).

### 10.257.3.3 ComputeBoundingBox()

```
virtual BoxRegion gdcm::Region::ComputeBoundingBox ( ) [pure virtual]
```

Return the Axis-Aligned minimum bounding box for all regions.

Implemented in [gdcm::BoxRegion](#).

### 10.257.3.4 Empty()

```
virtual bool gdcm::Region::Empty ( ) const [pure virtual]
```

return whether this domain is empty:

Implemented in [gdcm::BoxRegion](#).

### 10.257.3.5 IsValid()

```
virtual bool gdcm::Region::IsValid ( ) const [pure virtual]
```

return whether this is valid domain

Implemented in [gdcm::BoxRegion](#).

### 10.257.3.6 Print()

```
virtual void gdcM::Region::Print (
    std::ostream & os = std::cout ) const [virtual]
```

Print.

Reimplemented in [gdcM::BoxRegion](#).

Referenced by [gdcM::operator<<\(\)](#).

The documentation for this class was generated from the following file:

- [gdcMRegion.h](#)

## 10.258 gdcM::Rescaler Class Reference

Rescale class.

```
#include <gdcMRescaler.h>
```

### Public Member Functions

- [Rescaler](#) ()
- [~Rescaler](#) ()=default
- [PixelFormat::ScalarType ComputeInterceptSlopePixelFormat](#) ()
- [PixelFormat ComputePixelFormatFromMinMax](#) ()
- double [GetIntercept](#) () const
- double [GetSlope](#) () const
- bool [InverseRescale](#) (char \*out, const char \*in, size\_t n)
  - Inverse transform.*
- bool [Rescale](#) (char \*out, const char \*in, size\_t n)
  - Direct transform.*
- void [SetIntercept](#) (double i)
  - Set Intercept: used for both direct&inverse transformation.*
- void [SetMinMaxForPixelFormat](#) (double min, double max)
- void [SetPixelFormat](#) ([PixelFormat](#) const &pf)
  - Set Pixel Format of input data.*
- void [SetSlope](#) (double s)
  - Set Slope: user for both direct&inverse transformation.*
- void [SetTargetPixelFormat](#) ([PixelFormat](#) const &targetst)
- void [SetUseTargetPixelFormat](#) (bool b)
  - Override default behavior of Rescale.*

## Protected Member Functions

- `template<typename TIn >`  
void [InverseRescaleFunctionIntoBestFit](#) (char \*out, const TIn \*in, size\_t n)
- `template<typename TIn >`  
void [RescaleFunctionIntoBestFit](#) (char \*out, const TIn \*in, size\_t n)

### 10.258.1 Detailed Description

Rescale class.

This class is meant to apply the linear transform of Stored Pixel [Value](#) to Real World [Value](#). This is mostly found in CT or PET dataset, where the value are stored using one type, but need to be converted to another scale using a linear transform. There are basically two cases: In CT: the linear transform is generally integer based. E.g. the Stored Pixel [Type](#) is unsigned short 12bits, but to get Hounsfield unit, one need to apply the linear transform:

$$RWV = 1. * SV - 1024$$

So the best scalar to store the Real World [Value](#) will be 16 bits signed type.

In PET: the linear transform is generally floating point based. Since the dynamic range can be quite high, the Rescale Slope / Rescale Intercept can be changing throughout the [Series](#). So it is important to read all linear transform and deduce the best Pixel [Type](#) only at the end (when all the images to be read have been parsed).

#### Warning

Internally any time a floating point value is found either in the Rescale Slope or the Rescale Intercept it is assumed that the best matching output pixel type is FLOAT64 (in previous implementation it was FLOAT32). Because [VR:DS](#) is closer to a 64bits floating point type FLOAT64 is thus a best matching pixel type for the floating point transformation.

Example: Let say input is FLOAT64, and we want UINT16 as output, we would do:

```
Rescaler ir;
ir.SetIntercept( 0 );
ir.SetSlope( 5.6789 );
ir.SetPixelFormat( FLOAT64 );
ir.SetMinMaxForPixelType( ((PixelFormat)UINT16).GetMin(), ((PixelFormat)UINT16).GetMax() );
ir.InverseRescale(output, input, numberofbytes );
```

#### Note

handle floating point transformation back and forth to integer properly (no loss)

#### See also

[Unpacker12Bits](#)

### 10.258.2 Constructor & Destructor Documentation

### 10.258.2.1 Rescaler()

```
gdcM::Rescaler::Rescaler ( ) [inline]
```

### 10.258.2.2 ~Rescaler()

```
gdcM::Rescaler::~~Rescaler ( ) [default]
```

## 10.258.3 Member Function Documentation

### 10.258.3.1 ComputeInterceptSlopePixelType()

```
PixelFormat::ScalarType gdcM::Rescaler::ComputeInterceptSlopePixelType ( )
```

Compute the Pixel Format of the output data Used for direct transformation

### 10.258.3.2 ComputePixelTypeFromMinMax()

```
PixelFormat gdcM::Rescaler::ComputePixelTypeFromMinMax ( )
```

Compute the Pixel Format of the output data Used for inverse transformation

### 10.258.3.3 GetIntercept()

```
double gdcM::Rescaler::GetIntercept ( ) const [inline]
```

### 10.258.3.4 GetSlope()

```
double gdcM::Rescaler::GetSlope ( ) const [inline]
```



### 10.258.3.5 InverseRescale()

```
bool gdcm::Rescaler::InverseRescale (
    char * out,
    const char * in,
    size_t n )
```

Inverse transform.

### 10.258.3.6 InverseRescaleFunctionIntoBestFit()

```
template<typename TIn >
void gdcm::Rescaler::InverseRescaleFunctionIntoBestFit (
    char * out,
    const TIn * in,
    size_t n ) [protected]
```

### 10.258.3.7 Rescale()

```
bool gdcm::Rescaler::Rescale (
    char * out,
    const char * in,
    size_t n )
```

Direct transform.

### 10.258.3.8 RescaleFunctionIntoBestFit()

```
template<typename TIn >
void gdcm::Rescaler::RescaleFunctionIntoBestFit (
    char * out,
    const TIn * in,
    size_t n ) [protected]
```

### 10.258.3.9 SetIntercept()

```
void gdcm::Rescaler::SetIntercept (
    double i ) [inline]
```

Set Intercept: used for both direct&inverse transformation.

### 10.258.3.10 SetMinMaxForPixelType()

```
void gdcM::Rescaler::SetMinMaxForPixelType (
    double min,
    double max )
```

Set target interval for output data. A best match will be computed (if possible) Used for inverse transformation

### 10.258.3.11 SetPixelFormat()

```
void gdcM::Rescaler::SetPixelFormat (
    PixelFormat const & pf ) [inline]
```

Set Pixel Format of input data.

### 10.258.3.12 SetSlope()

```
void gdcM::Rescaler::SetSlope (
    double s ) [inline]
```

Set Slope: user for both direct&inverse transformation.

### 10.258.3.13 SetTargetPixelFormat()

```
void gdcM::Rescaler::SetTargetPixelFormat (
    PixelFormat const & targetst )
```

By default (when UseTargetPixelFormat is false), a best matching Target Pixel [Type](#) is computed. However user can override this auto selection by switching UseTargetPixelFormat:true and also specifying the specifix Target Pixel [Type](#)

### 10.258.3.14 SetUseTargetPixelFormat()

```
void gdcM::Rescaler::SetUseTargetPixelFormat (
    bool b )
```

Override default behavior of Rescale.

The documentation for this class was generated from the following file:

- [gdcMRescaler.h](#)

## 10.259 gdcm::RLECodec Class Reference

Class to do RLE.

```
#include <gdcmRLECodec.h>
```

Inheritance diagram for gdcm::RLECodec:

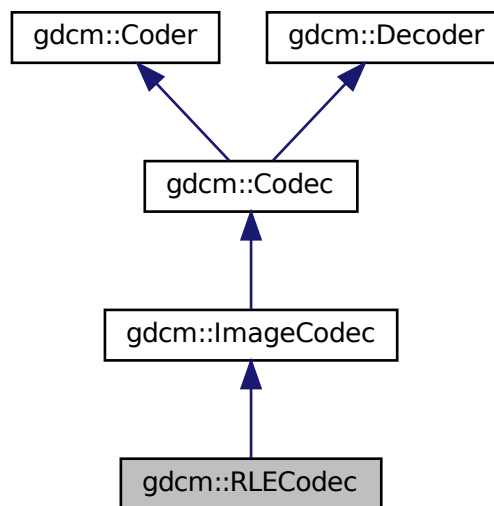

Collaboration diagram for gdcm::RLECodec:

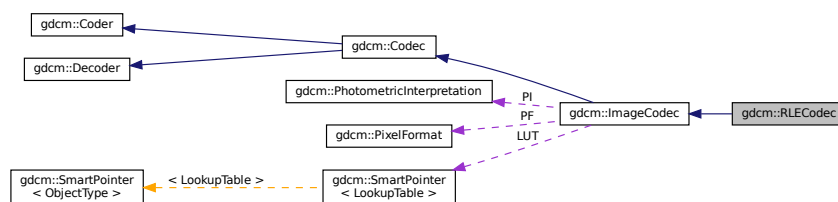

### Public Member Functions

- [RLECodec \(\)](#)
- [~RLECodec \(\)](#) override
- bool [CanCode \(TransferSyntax const &ts\)](#) const override

*Return whether this coder support this transfer syntax (can code it)*

- bool [CanDecode](#) ([TransferSyntax](#) const &ts) const override

*Return whether this decoder support this transfer syntax (can decode it)*

- [ImageCodec](#) \* [Clone](#) () const override
- bool [Code](#) ([DataElement](#) const &in, [DataElement](#) &out) override

*Code.*

- bool [Decode](#) ([DataElement](#) const &is, [DataElement](#) &os) override

*Decode.*

- unsigned long [GetBufferLength](#) () const
- bool [GetHeaderInfo](#) (std::istream &is, [TransferSyntax](#) &ts) override
- void [SetBufferLength](#) (unsigned long l)
- void [SetLength](#) (unsigned long l)

## Protected Member Functions

- bool [AppendFrameEncode](#) (std::ostream &out, const char \*data, size\_t datalen) override
- bool [AppendRowEncode](#) (std::ostream &out, const char \*data, size\_t datalen) override
- bool [DecodeByStreams](#) (std::istream &is, std::ostream &os) override
- bool [DecodeExtent](#) (char \*buffer, unsigned int XMin, unsigned int XMax, unsigned int YMin, unsigned int YMax, unsigned int ZMin, unsigned int ZMax, std::istream &is)
- bool [IsFrameEncoder](#) () override
- bool [IsRowEncoder](#) () override
- bool [StartEncode](#) (std::ostream &) override
- bool [StopEncode](#) (std::ostream &) override

## Friends

- class [ImageRegionReader](#)

## Additional Inherited Members

### 10.259.1 Detailed Description

Class to do RLE.

#### Note

ANSI X3.9 A.4.2 RLE Compression Annex G defines a RLE Compression Transfer Syntax. This transfer Syntax is identified by the UID value "1.2.840.10008.1.2.5". If the object allows multi-frame images in the pixel data field, then each frame shall be encoded separately. Each frame shall be encoded in one and only one [Fragment](#) (see PS 3.5.8.2).

### 10.259.2 Constructor & Destructor Documentation

### 10.259.2.1 RLECodec()

```
gdcm::RLECodec::RLECodec ( )
```

### 10.259.2.2 ~RLECodec()

```
gdcm::RLECodec::~~RLECodec ( ) [override]
```

## 10.259.3 Member Function Documentation

### 10.259.3.1 AppendFrameEncode()

```
bool gdcm::RLECodec::AppendFrameEncode (
    std::ostream & out,
    const char * data,
    size_t datalen ) [override], [protected], [virtual]
```

Reimplemented from [gdcm::ImageCodec](#).

### 10.259.3.2 AppendRowEncode()

```
bool gdcm::RLECodec::AppendRowEncode (
    std::ostream & out,
    const char * data,
    size_t datalen ) [override], [protected], [virtual]
```

Reimplemented from [gdcm::ImageCodec](#).

### 10.259.3.3 CanCode()

```
bool gdcm::RLECodec::CanCode (
    TransferSyntax const & ) const [override], [virtual]
```

Return whether this coder support this transfer syntax (can code it)

Reimplemented from [gdcm::ImageCodec](#).

#### 10.259.3.4 CanDecode()

```
bool gdcm::RLECodec::CanDecode (
    TransferSyntax const & ) const [override], [virtual]
```

Return whether this decoder support this transfer syntax (can decode it)

Reimplemented from [gdcm::ImageCodec](#).

#### 10.259.3.5 Clone()

```
ImageCodec* gdcm::RLECodec::Clone ( ) const [override], [virtual]
```

Implements [gdcm::ImageCodec](#).

#### 10.259.3.6 Code()

```
bool gdcm::RLECodec::Code (
    DataElement const & in_,
    DataElement & out_ ) [override], [virtual]
```

Code.

Reimplemented from [gdcm::Coder](#).

#### 10.259.3.7 Decode()

```
bool gdcm::RLECodec::Decode (
    DataElement const & ,
    DataElement & ) [override], [virtual]
```

Decode.

Reimplemented from [gdcm::ImageCodec](#).

### 10.259.3.8 DecodeByStreams()

```
bool gdcm::RLECodec::DecodeByStreams (
    std::istream & is,
    std::ostream & os ) [override], [protected], [virtual]
```

Reimplemented from [gdcm::ImageCodec](#).

### 10.259.3.9 DecodeExtent()

```
bool gdcm::RLECodec::DecodeExtent (
    char * buffer,
    unsigned int XMin,
    unsigned int XMax,
    unsigned int YMin,
    unsigned int YMax,
    unsigned int ZMin,
    unsigned int ZMax,
    std::istream & is ) [protected]
```

### 10.259.3.10 GetBufferLength()

```
unsigned long gdcm::RLECodec::GetBufferLength ( ) const [inline]
```

### 10.259.3.11 GetHeaderInfo()

```
bool gdcm::RLECodec::GetHeaderInfo (
    std::istream & is,
    TransferSyntax & ts ) [override], [virtual]
```

Reimplemented from [gdcm::ImageCodec](#).

### 10.259.3.12 IsFrameEncoder()

```
bool gdcm::RLECodec::IsFrameEncoder ( ) [override], [protected], [virtual]
```

Reimplemented from [gdcm::ImageCodec](#).

### 10.259.3.13 IsRowEncoder()

```
bool gdcM::RLECodec::IsRowEncoder ( ) [override], [protected], [virtual]
```

Reimplemented from [gdcM::ImageCodec](#).

### 10.259.3.14 SetBufferLength()

```
void gdcM::RLECodec::SetBufferLength (
    unsigned long l ) [inline]
```

### 10.259.3.15 SetLength()

```
void gdcM::RLECodec::SetLength (
    unsigned long l ) [inline]
```

### 10.259.3.16 StartEncode()

```
bool gdcM::RLECodec::StartEncode (
    std::ostream & ) [override], [protected], [virtual]
```

Reimplemented from [gdcM::ImageCodec](#).

### 10.259.3.17 StopEncode()

```
bool gdcM::RLECodec::StopEncode (
    std::ostream & ) [override], [protected], [virtual]
```

Reimplemented from [gdcM::ImageCodec](#).

## 10.259.4 Friends And Related Function Documentation



### 10.259.4.1 ImageRegionReader

```
friend class ImageRegionReader [friend]
```

The documentation for this class was generated from the following file:

- [gdcmRLECodec.h](#)

## 10.260 gdcm::network::RoleSelectionSub Class Reference

[RoleSelectionSub](#).

```
#include <gdcmRoleSelectionSub.h>
```

### Public Member Functions

- [RoleSelectionSub](#) ()
- void [Print](#) (std::ostream &os) const
- std::istream & [Read](#) (std::istream &is)
- void [SetTuple](#) (const char \*uid, uint8\_t scurole, uint8\_t scprole)
- size\_t [Size](#) () const
- const std::ostream & [Write](#) (std::ostream &os) const

### 10.260.1 Detailed Description

[RoleSelectionSub](#).

PS 3.7 [Table D.3-9](#) SCP/SCU ROLE SELECTION SUB-ITEM FIELDS (A-ASSOCIATE-RQ)

### 10.260.2 Constructor & Destructor Documentation

#### 10.260.2.1 RoleSelectionSub()

```
gdcm::network::RoleSelectionSub::RoleSelectionSub ( )
```

### 10.260.3 Member Function Documentation

### 10.260.3.1 Print()

```
void gdcM::network::RoleSelectionSub::Print (
    std::ostream & os ) const
```

### 10.260.3.2 Read()

```
std::istream& gdcM::network::RoleSelectionSub::Read (
    std::istream & is )
```

### 10.260.3.3 SetTuple()

```
void gdcM::network::RoleSelectionSub::SetTuple (
    const char * uid,
    uint8_t scurole,
    uint8_t scprole )
```

### 10.260.3.4 Size()

```
size_t gdcM::network::RoleSelectionSub::Size ( ) const
```

### 10.260.3.5 Write()

```
const std::ostream& gdcM::network::RoleSelectionSub::Write (
    std::ostream & os ) const
```

The documentation for this class was generated from the following file:

- [gdcMRoleSelectionSub.h](#)

## 10.261 gdcM::Scanner Class Reference

[Scanner](#).

```
#include <gdcMScanner.h>
```

Inheritance diagram for gdcM::Scanner:

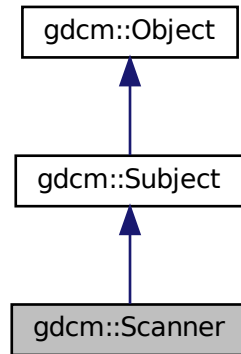

Collaboration diagram for gdcM::Scanner:

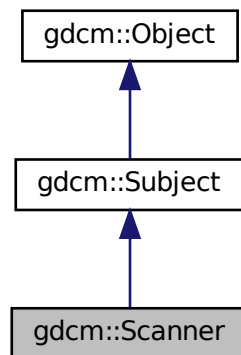

### Classes

- struct [ltstr](#)

## Public Types

- typedef MappingType::const\_iterator [ConstIterator](#)
- typedef std::map< const char \*, [TagToValue](#), [Itstr](#) > [MappingType](#)
- typedef std::map< [Tag](#), const char \* > [TagToValue](#)
- typedef TagToValue::value\_type [TagToValueValueType](#)
- typedef std::set< std::string > [ValuesType](#)

## Public Member Functions

- [Scanner](#) ()
- [~Scanner](#) () override
- void [AddPrivateTag](#) ([PrivateTag](#) const &t)
- void [AddSkipTag](#) ([Tag](#) const &t)
  - *Add a tag that will need to be skipped. Those are root level skip tags.*
- void [AddTag](#) ([Tag](#) const &t)
  - *Add a tag that will need to be read. Those are root level tags.*
- [ConstIterator](#) [Begin](#) () const
- void [ClearSkipTags](#) ()
- void [ClearTags](#) ()
- [ConstIterator](#) [End](#) () const
- [Directory::FilenamesType](#) [GetAllFilenamesFromTagToValue](#) ([Tag](#) const &t, const char \*valueref) const
- const char \* [GetFilenameFromTagToValue](#) ([Tag](#) const &t, const char \*valueref) const
- [Directory::FilenamesType](#) const & [GetFilenames](#) () const
- [Directory::FilenamesType](#) [GetKeys](#) () const
- [TagToValue](#) const & [GetMapping](#) (const char \*filename) const
  - *Get the std::map mapping filenames to value for file 'filename'.*
- [TagToValue](#) const & [GetMappingFromTagToValue](#) ([Tag](#) const &t, const char \*value) const
  - *See [GetFilenameFromTagToValue\(\)](#). This is simply [GetFilenameFromTagToValue](#) followed.*
- [MappingType](#) const & [GetMappings](#) () const
  - *Mappings are the mapping from a particular tag to the map, mapping filename to value:*
- [Directory::FilenamesType](#) [GetOrderedValues](#) ([Tag](#) const &t) const
- const char \* [GetValue](#) (const char \*filename, [Tag](#) const &t) const
- [ValuesType](#) const & [GetValues](#) () const
  - *Get all the values found (in lexicographic order)*
- [ValuesType](#) [GetValues](#) ([Tag](#) const &t) const
  - *Get all the values found (in lexicographic order) associated with [Tag](#) 't'.*
- bool [IsKey](#) (const char \*filename) const
- void [Print](#) (std::ostream &os) const override
  - *Print result.*
- void [PrintTable](#) (std::ostream &os) const
- bool [Scan](#) ([Directory::FilenamesType](#) const &filenames)
  - *Start the scan !*

## Static Public Member Functions

- static [SmartPointer](#)< [Scanner](#) > [New](#) ()
  - *for wrapped language: instantiate a reference counted object*

## Protected Member Functions

- void [ProcessPublicTag](#) ([StringFilter](#) &sf, const char \*filename)

## Friends

- std::ostream & [operator<<](#) (std::ostream &\_os, const [Scanner](#) &s)

### 10.261.1 Detailed Description

#### [Scanner](#).

This filter is meant for quickly browsing a [FileSet](#) (a set of files on disk). Special consideration are taken so as to read the minimum amount of information in each file in order to retrieve the user specified set of DICOM [Attribute](#).

This filter is dealing with both VRASCII and VRBINARY element, thanks to the help of [StringFilter](#)

#### Warning

IMPORTANT In case of file where tags are not ordered (illegal as per DICOM specification), the output will be missing information

#### Note

implementation details. All values are stored in a std::set of std::string. Then the address of the cstring underlying the std::string is used in the std::map.

This class implement the Subject/Observer pattern trigger the following events:

- [ProgressEvent](#)
- [StartEvent](#)
- [EndEvent](#)

#### Examples

[DiscriminateVolume.cxx](#), [DumpToSQLITE3.cxx](#), [SortImage.cxx](#), and [VolumeSorter.cxx](#).

### 10.261.2 Member Typedef Documentation

#### 10.261.2.1 ConstIterator

```
typedef MappingType::const_iterator gdcmm::Scanner::ConstIterator
```

### 10.261.2.2 MappingType

```
typedef std::map<const char *,TagToValue, ltstr> gdcM::Scanner::MappingType
```

### 10.261.2.3 TagToValue

```
typedef std::map<Tag, const char*> gdcM::Scanner::TagToValue
```

struct to map a filename to a value Implementation note: all std::map in this class will be using const char \* and not std::string since we are pointing to existing std::string (hold in a std::vector) this avoid an extra copy of the byte array. Tag are used as Tag class since sizeof(tag) <= sizeof(pointer)

### 10.261.2.4 TagToValueValueType

```
typedef TagToValue::value_type gdcM::Scanner::TagToValueValueType
```

### 10.261.2.5 ValuesType

```
typedef std::set< std::string > gdcM::Scanner::ValuesType
```

## 10.261.3 Constructor & Destructor Documentation

### 10.261.3.1 Scanner()

```
gdcM::Scanner::Scanner ( ) [inline]
```

### 10.261.3.2 ~Scanner()

```
gdcM::Scanner::~~Scanner ( ) [override]
```

## 10.261.4 Member Function Documentation

#### 10.261.4.1 AddPrivateTag()

```
void gdcM::Scanner::AddPrivateTag (
    PrivateTag const & t )
```

#### 10.261.4.2 AddSkipTag()

```
void gdcM::Scanner::AddSkipTag (
    Tag const & t )
```

Add a tag that will need to be skipped. Those are root level skip tags.

#### 10.261.4.3 AddTag()

```
void gdcM::Scanner::AddTag (
    Tag const & t )
```

Add a tag that will need to be read. Those are root level tags.

#### Examples

[DiscriminateVolume.cxx](#), [DumpToSQLITE3.cxx](#), [SortImage.cxx](#), and [VolumeSorter.cxx](#).

#### 10.261.4.4 Begin()

```
ConstIterator gdcM::Scanner::Begin ( ) const [inline]
```

#### 10.261.4.5 ClearSkipTags()

```
void gdcM::Scanner::ClearSkipTags ( )
```

#### 10.261.4.6 ClearTags()

```
void gdcM::Scanner::ClearTags ( )
```

#### 10.261.4.7 End()

```
ConstIterator gdcM::Scanner::End ( ) const [inline]
```

#### 10.261.4.8 GetAllFileNamesFromTagToValue()

```
Directory::FileNamesType gdcM::Scanner::GetAllFileNamesFromTagToValue (
    Tag const & t,
    const char * valuref ) const
```

Will loop over all files and return a vector of std::strings of filenames where value match the reference value 'valuref'

#### 10.261.4.9 GetFilenameFromTagToValue()

```
const char* gdcM::Scanner::GetFilenameFromTagToValue (
    Tag const & t,
    const char * valuref ) const
```

Will loop over all files and return the first file where value match the reference value 'valuref'

#### 10.261.4.10 GetFileNames()

```
Directory::FileNamesType const& gdcM::Scanner::GetFileNames ( ) const [inline]
```

#### 10.261.4.11 GetKeys()

```
Directory::FileNamesType gdcM::Scanner::GetKeys ( ) const
```

Return the list of filename that are key in the internal map, which means those filename were properly parsed

#### Examples

[VolumeSorter.cxx](#).



#### 10.261.4.12 GetMapping()

```
TagToValue const& gdcM::Scanner::GetMapping (
    const char * filename ) const
```

Get the std::map mapping filenames to value for file 'filename'.

##### Examples

[DumpToSQLITE3.cxx](#).

#### 10.261.4.13 GetMappingFromTagToValue()

```
TagToValue const& gdcM::Scanner::GetMappingFromTagToValue (
    Tag const & t,
    const char * value ) const
```

See [GetFilenameFromTagToValue\(\)](#). This is simply [GetFilenameFromTagToValue](#) followed.

#### 10.261.4.14 GetMappings()

```
MappingType const& gdcM::Scanner::GetMappings ( ) const [inline]
```

Mappings are the mapping from a particular tag to the map, mapping filename to value:

#### 10.261.4.15 GetOrderedValues()

```
Directory::FileNamesType gdcM::Scanner::GetOrderedValues (
    Tag const & t ) const
```

Get all the values found (in a vector) associated with [Tag](#) 't' This function is identical to [GetValues](#), but is accessible from the wrapped layer (python, C#, java)

#### 10.261.4.16 GetValue()

```
const char* gdcM::Scanner::GetValue (
    const char * filename,
    Tag const & t ) const
```

Retrieve the value found for tag: t associated with file: filename This is meant for a single short call. If multiple calls (multiple tags) should be done, prefer the [GetMapping](#) function, and then reuse the [TagToValue](#) hash table.

##### Warning

[Tag](#) 't' should have been added via [AddTag\(\)](#) prior to the [Scan\(\)](#) call !

#### 10.261.4.17 GetValues() [1/2]

```
ValueType const& gdcM::Scanner::GetValues ( ) const [inline]
```

Get all the values found (in lexicographic order)

##### Examples

[SortImage.cxx](#), and [VolumeSorter.cxx](#).

#### 10.261.4.18 GetValues() [2/2]

```
ValueType gdcM::Scanner::GetValues (
    Tag const & t ) const
```

Get all the values found (in lexicographic order) associated with [Tag](#) 't'.

#### 10.261.4.19 IsKey()

```
bool gdcM::Scanner::IsKey (
    const char * filename ) const
```

Check if filename is a key in the Mapping table. returns true only if file can be found, which means the file was indeed a DICOM file that could be processed

##### Examples

[DumpToSQLITE3.cxx](#).

#### 10.261.4.20 New()

```
static SmartPointer<Scanner> gdcM::Scanner::New ( ) [inline], [static]
```

for wrapped language: instantiate a reference counted object

#### 10.261.4.21 Print()

```
void gdcmm::Scanner::Print (
    std::ostream & os ) const [override], [virtual]
```

Print result.

Reimplemented from [gdcmm::Object](#).

#### 10.261.4.22 PrintTable()

```
void gdcmm::Scanner::PrintTable (
    std::ostream & os ) const
```

#### 10.261.4.23 ProcessPublicTag()

```
void gdcmm::Scanner::ProcessPublicTag (
    StringFilter & sf,
    const char * filename ) [protected]
```

#### 10.261.4.24 Scan()

```
bool gdcmm::Scanner::Scan (
    Directory::FilenameType const & filenames )
```

Start the scan !

#### Examples

[DiscriminateVolume.cxx](#), [DumpToSQLITE3.cxx](#), [SortImage.cxx](#), and [VolumeSorter.cxx](#).

### 10.261.5 Friends And Related Function Documentation

### 10.261.5.1 operator<<

```
std::ostream& operator<< (
    std::ostream & _oS,
    const Scanner & s ) [friend]
```

The documentation for this class was generated from the following file:

- [gdcmscanner.h](#)

## 10.262 gdcmscanner::Segment Class Reference

This class defines a segment.

```
#include <gdcmscanner.h>
```

Inheritance diagram for gdcmscanner::Segment:

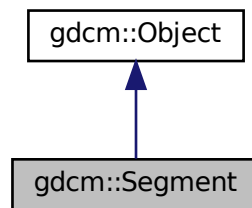

Collaboration diagram for gdcmscanner::Segment:

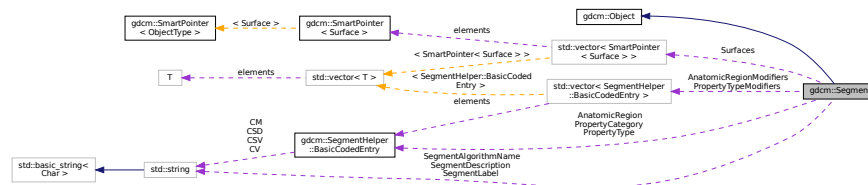

## Public Types

- enum [ALGOType](#) {  
[AUTOMATIC](#) = 0 ,  
[SEMIAUTOMATIC](#) ,  
[MANUAL](#) ,  
[ALGOType\\_END](#) }
- typedef std::vector< [SegmentHelper::BasicCodedEntry](#) > [BasicCodedEntryVector](#)
- typedef std::vector< [SmartPointer](#)< [Surface](#) > > [SurfaceVector](#)

## Public Member Functions

- [Segment](#) ()
- [~Segment](#) () override
- void [AddSurface](#) ([SmartPointer](#)< [Surface](#) > surface)
- [SegmentHelper::BasicCodedEntry](#) & [GetAnatomicRegion](#) ()
- [SegmentHelper::BasicCodedEntry](#) const & [GetAnatomicRegion](#) () const
- [BasicCodedEntryVector](#) & [GetAnatomicRegionModifiers](#) ()
- [BasicCodedEntryVector](#) const & [GetAnatomicRegionModifiers](#) () const
- [SegmentHelper::BasicCodedEntry](#) & [GetPropertyCategory](#) ()
- [SegmentHelper::BasicCodedEntry](#) const & [GetPropertyCategory](#) () const
- [SegmentHelper::BasicCodedEntry](#) & [GetPropertyType](#) ()
- [SegmentHelper::BasicCodedEntry](#) const & [GetPropertyType](#) () const
- [BasicCodedEntryVector](#) & [GetPropertyTypeModifiers](#) ()
- [BasicCodedEntryVector](#) const & [GetPropertyTypeModifiers](#) () const
- const char \* [GetSegmentAlgorithmName](#) () const
- [ALGOType](#) [GetSegmentAlgorithmType](#) () const
- const char \* [GetSegmentDescription](#) () const
- const char \* [GetSegmentLabel](#) () const
- unsigned short [GetSegmentNumber](#) () const
- [SmartPointer](#)< [Surface](#) > [GetSurface](#) (const unsigned int idx=0) const
- unsigned long [GetSurfaceCount](#) ()
- [SurfaceVector](#) & [GetSurfaces](#) ()
- [SurfaceVector](#) const & [GetSurfaces](#) () const
- void [SetAnatomicRegion](#) ([SegmentHelper::BasicCodedEntry](#) const &BSE)
- void [SetAnatomicRegionModifiers](#) ([BasicCodedEntryVector](#) const &BSEV)
- void [SetPropertyCategory](#) ([SegmentHelper::BasicCodedEntry](#) const &BSE)
- void [SetPropertyType](#) ([SegmentHelper::BasicCodedEntry](#) const &BSE)
- void [SetPropertyTypeModifiers](#) ([BasicCodedEntryVector](#) const &BSEV)
- void [SetSegmentAlgorithmName](#) (const char \*name)
- void [SetSegmentAlgorithmType](#) ([ALGOType](#) type)
- void [SetSegmentAlgorithmType](#) (const char \*typeStr)
- void [SetSegmentDescription](#) (const char \*description)
- void [SetSegmentLabel](#) (const char \*label)
- void [SetSegmentNumber](#) (const unsigned short num)
- void [SetSurfaceCount](#) (const unsigned long nb)

## Static Public Member Functions

- static [ALGOType](#) [GetALGOType](#) (const char \*type)
- static const char \* [GetALGOTypeString](#) ([ALGOType](#) type)

## Protected Attributes

- [SegmentHelper::BasicCodedEntry](#) [AnatomicRegion](#)
- [BasicCodedEntryVector](#) [AnatomicRegionModifiers](#)
- [SegmentHelper::BasicCodedEntry](#) [PropertyCategory](#)
- [SegmentHelper::BasicCodedEntry](#) [PropertyType](#)
- [BasicCodedEntryVector](#) [PropertyTypeModifiers](#)
- `std::string` [SegmentAlgorithmName](#)
- [ALGOType](#) [SegmentAlgorithmType](#)
- `std::string` [SegmentDescription](#)
- `std::string` [SegmentLabel](#)
- `unsigned short` [SegmentNumber](#)
- `unsigned long` [SurfaceCount](#)
- [SurfaceVector](#) [Surfaces](#)

## Additional Inherited Members

### 10.262.1 Detailed Description

This class defines a segment.

It mainly contains attributes of group 0x0062. In addition, it can be associated with surface.

See also

PS 3.3 C.8.20.2 and C.8.23

### 10.262.2 Member Typedef Documentation

#### 10.262.2.1 BasicCodedEntryVector

```
typedef std::vector< SegmentHelper::BasicCodedEntry > gdcm::Segment::BasicCodedEntryVector
```

#### 10.262.2.2 SurfaceVector

```
typedef std::vector< SmartPointer< Surface > > gdcm::Segment::SurfaceVector
```

### 10.262.3 Member Enumeration Documentation

#### 10.262.3.1 ALGOType

```
enum gdcm::Segment::ALGOType
```

## Enumerator

AUTOMATIC	
SEMIAUTOMATIC	
MANUAL	
ALGOType_END	

## 10.262.4 Constructor & Destructor Documentation

### 10.262.4.1 Segment()

```
gdcm::Segment::Segment ( )
```

### 10.262.4.2 ~Segment()

```
gdcm::Segment::~~Segment ( ) [override]
```

## 10.262.5 Member Function Documentation

### 10.262.5.1 AddSurface()

```
void gdcm::Segment::AddSurface (
    SmartPointer< Surface > surface )
```

### 10.262.5.2 GetALGOType()

```
static ALGOType gdcm::Segment::GetALGOType (
    const char * type ) [static]
```

### 10.262.5.3 GetALGOTypeString()

```
static const char* gdcM::Segment::GetALGOTypeString (
    ALGOType type ) [static]
```

### 10.262.5.4 GetAnatomicRegion() [1/2]

```
SegmentHelper::BasicCodedEntry& gdcM::Segment::GetAnatomicRegion ( )
```

### 10.262.5.5 GetAnatomicRegion() [2/2]

```
SegmentHelper::BasicCodedEntry const& gdcM::Segment::GetAnatomicRegion ( ) const
```

### 10.262.5.6 GetAnatomicRegionModifiers() [1/2]

```
BasicCodedEntryVector& gdcM::Segment::GetAnatomicRegionModifiers ( )
```

### 10.262.5.7 GetAnatomicRegionModifiers() [2/2]

```
BasicCodedEntryVector const& gdcM::Segment::GetAnatomicRegionModifiers ( ) const
```

### 10.262.5.8 GetPropertyCategory() [1/2]

```
SegmentHelper::BasicCodedEntry& gdcM::Segment::GetPropertyCategory ( )
```

### 10.262.5.9 GetPropertyCategory() [2/2]

```
SegmentHelper::BasicCodedEntry const& gdcM::Segment::GetPropertyCategory ( ) const
```



**10.262.5.10 GetPropertyType() [1/2]**

```
SegmentHelper::BasicCodedEntry& gdcm::Segment::GetPropertyType ( )
```

**10.262.5.11 GetPropertyType() [2/2]**

```
SegmentHelper::BasicCodedEntry const& gdcm::Segment::GetPropertyType ( ) const
```

**10.262.5.12 GetPropertyTypeModifiers() [1/2]**

```
BasicCodedEntryVector& gdcm::Segment::GetPropertyTypeModifiers ( )
```

**10.262.5.13 GetPropertyTypeModifiers() [2/2]**

```
BasicCodedEntryVector const& gdcm::Segment::GetPropertyTypeModifiers ( ) const
```

**10.262.5.14 GetSegmentAlgorithmName()**

```
const char* gdcm::Segment::GetSegmentAlgorithmName ( ) const
```

**10.262.5.15 GetSegmentAlgorithmType()**

```
ALGOType gdcm::Segment::GetSegmentAlgorithmType ( ) const
```

**10.262.5.16 GetSegmentDescription()**

```
const char* gdcm::Segment::GetSegmentDescription ( ) const
```

### 10.262.5.17 GetSegmentLabel()

```
const char* gdcM::Segment::GetSegmentLabel ( ) const
```

### 10.262.5.18 GetSegmentNumber()

```
unsigned short gdcM::Segment::GetSegmentNumber ( ) const
```

### 10.262.5.19 GetSurface()

```
SmartPointer< Surface > gdcM::Segment::GetSurface (
    const unsigned int idx = 0 ) const
```

### 10.262.5.20 GetSurfaceCount()

```
unsigned long gdcM::Segment::GetSurfaceCount ( )
```

### 10.262.5.21 GetSurfaces() [1/2]

```
SurfaceVector& gdcM::Segment::GetSurfaces ( )
```

### 10.262.5.22 GetSurfaces() [2/2]

```
SurfaceVector const& gdcM::Segment::GetSurfaces ( ) const
```

### 10.262.5.23 SetAnatomicRegion()

```
void gdcM::Segment::SetAnatomicRegion (
    SegmentHelper::BasicCodedEntry const & BSE )
```

#### 10.262.5.24 SetAnatomicRegionModifiers()

```
void gdcm::Segment::SetAnatomicRegionModifiers (
    BasicCodedEntryVector const & BSEV )
```

#### 10.262.5.25 SetPropertyCategory()

```
void gdcm::Segment::SetPropertyCategory (
    SegmentHelper::BasicCodedEntry const & BSE )
```

#### 10.262.5.26 SetPropertyType()

```
void gdcm::Segment::SetPropertyType (
    SegmentHelper::BasicCodedEntry const & BSE )
```

#### 10.262.5.27 SetPropertyTypeModifiers()

```
void gdcm::Segment::SetPropertyTypeModifiers (
    BasicCodedEntryVector const & BSEV )
```

#### 10.262.5.28 SetSegmentAlgorithmName()

```
void gdcm::Segment::SetSegmentAlgorithmName (
    const char * name )
```

#### 10.262.5.29 SetSegmentAlgorithmType() [1/2]

```
void gdcm::Segment::SetSegmentAlgorithmType (
    ALGOType type )
```

### 10.262.5.30 SetSegmentAlgorithmType() [2/2]

```
void gdcM::Segment::SetSegmentAlgorithmType (
    const char * typeStr )
```

### 10.262.5.31 SetSegmentDescription()

```
void gdcM::Segment::SetSegmentDescription (
    const char * description )
```

### 10.262.5.32 SetSegmentLabel()

```
void gdcM::Segment::SetSegmentLabel (
    const char * label )
```

### 10.262.5.33 SetSegmentNumber()

```
void gdcM::Segment::SetSegmentNumber (
    const unsigned short num )
```

### 10.262.5.34 SetSurfaceCount()

```
void gdcM::Segment::SetSurfaceCount (
    const unsigned long nb )
```

## 10.262.6 Member Data Documentation

### 10.262.6.1 AnatomicRegion

[SegmentHelper::BasicCodedEntry](#) gdcM::Segment::AnatomicRegion [protected]

### 10.262.6.2 AnatomicRegionModifiers

`BasicCodedEntryVector` `gdcm::Segment::AnatomicRegionModifiers` [protected]

### 10.262.6.3 PropertyCategory

`SegmentHelper::BasicCodedEntry` `gdcm::Segment::PropertyCategory` [protected]

### 10.262.6.4 PropertyType

`SegmentHelper::BasicCodedEntry` `gdcm::Segment::PropertyType` [protected]

### 10.262.6.5 PropertyTypeModifiers

`BasicCodedEntryVector` `gdcm::Segment::PropertyTypeModifiers` [protected]

### 10.262.6.6 SegmentAlgorithmName

`std::string` `gdcm::Segment::SegmentAlgorithmName` [protected]

### 10.262.6.7 SegmentAlgorithmType

`ALGOType` `gdcm::Segment::SegmentAlgorithmType` [protected]

### 10.262.6.8 SegmentDescription

`std::string` `gdcm::Segment::SegmentDescription` [protected]

### 10.262.6.9 SegmentLabel

```
std::string gdcM::Segment::SegmentLabel [protected]
```

### 10.262.6.10 SegmentNumber

```
unsigned short gdcM::Segment::SegmentNumber [protected]
```

### 10.262.6.11 SurfaceCount

```
unsigned long gdcM::Segment::SurfaceCount [protected]
```

### 10.262.6.12 Surfaces

```
SurfaceVector gdcM::Segment::Surfaces [protected]
```

The documentation for this class was generated from the following file:

- [gdcMSegment.h](#)

## 10.263 gdcM::SegmentedPaletteColorLookupTable Class Reference

[SegmentedPaletteColorLookupTable](#) class.

```
#include <gdcMSegmentedPaletteColorLookupTable.h>
```

Inheritance diagram for gdcM::SegmentedPaletteColorLookupTable:

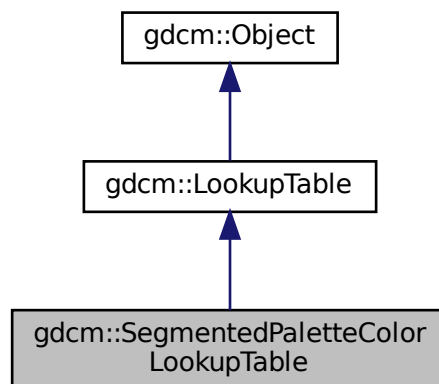

Collaboration diagram for gdcm::SegmentedPaletteColorLookupTable:

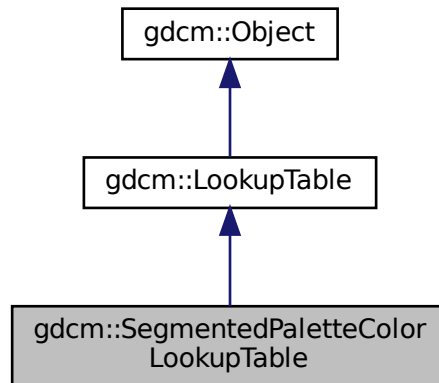

## Public Member Functions

- [SegmentedPaletteColorLookupTable](#) ()
- [~SegmentedPaletteColorLookupTable](#) () override
- void [Print](#) (std::ostream &) const override
- void [SetLUT](#) ([LookupTableType](#) type, const unsigned char \*array, unsigned int length) override  
*Initialize a [SegmentedPaletteColorLookupTable](#).*

## Additional Inherited Members

### 10.263.1 Detailed Description

[SegmentedPaletteColorLookupTable](#) class.

### 10.263.2 Constructor & Destructor Documentation

#### 10.263.2.1 [SegmentedPaletteColorLookupTable](#)()

```
gdcm::SegmentedPaletteColorLookupTable::SegmentedPaletteColorLookupTable ( )
```

### 10.263.2.2 ~SegmentedPaletteColorLookupTable()

```
gdcM::SegmentedPaletteColorLookupTable::~~SegmentedPaletteColorLookupTable ( ) [override]
```

## 10.263.3 Member Function Documentation

### 10.263.3.1 Print()

```
void gdcM::SegmentedPaletteColorLookupTable::Print (
    std::ostream & ) const [inline], [override], [virtual]
```

Reimplemented from [gdcM::LookupTable](#).

### 10.263.3.2 SetLUT()

```
void gdcM::SegmentedPaletteColorLookupTable::SetLUT (
    LookupTableType type,
    const unsigned char * array,
    unsigned int length ) [override], [virtual]
```

Initialize a [SegmentedPaletteColorLookupTable](#).

Reimplemented from [gdcM::LookupTable](#).

The documentation for this class was generated from the following file:

- [gdcMSegmentedPaletteColorLookupTable.h](#)



## 10.264 gdcm::SegmentReader Class Reference

This class defines a segment reader.

```
#include <gdcmSegmentReader.h>
```

Inheritance diagram for gdcm::SegmentReader:

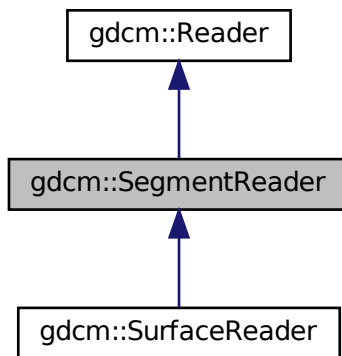

Collaboration diagram for gdcm::SegmentReader:

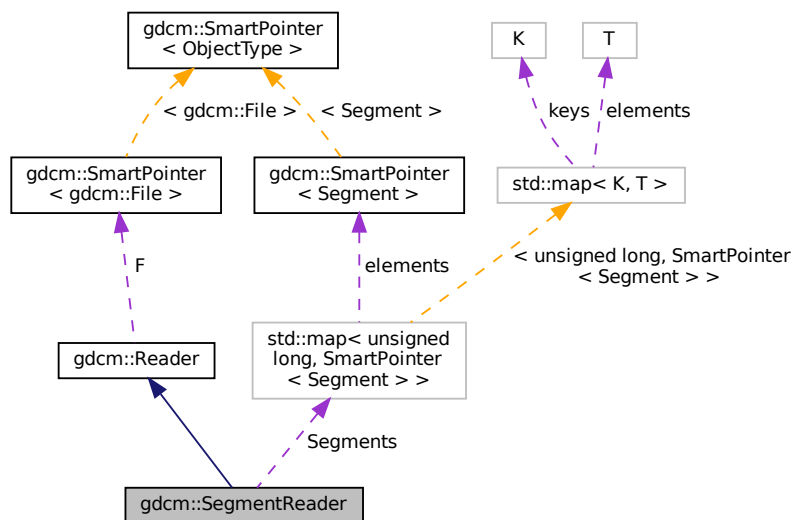

## Public Types

- typedef std::vector< [SmartPointer](#)< [Segment](#) > > [SegmentVector](#)

## Public Member Functions

- [SegmentReader](#) ()
- [~SegmentReader](#) () override
- [SegmentVector](#) [GetSegments](#) ()
- const [SegmentVector](#) [GetSegments](#) () const
- bool [Read](#) () override

*Read.*

## Protected Types

- typedef std::map< unsigned long, [SmartPointer](#)< [Segment](#) > > [SegmentMap](#)

## Protected Member Functions

- bool [ReadSegment](#) (const [Item](#) &segmentItem, const unsigned int idx)
- bool [ReadSegments](#) ()

## Protected Attributes

- [SegmentMap](#) [Segments](#)

### 10.264.1 Detailed Description

This class defines a segment reader.

It reads attributes of group 0x0062.

See also

PS 3.3 C.8.20.2 and C.8.23

### 10.264.2 Member Typedef Documentation

### 10.264.2.1 SegmentMap

```
typedef std::map< unsigned long, SmartPointer< Segment > > gdcm::SegmentReader::SegmentMap [protected]
```

### 10.264.2.2 SegmentVector

```
typedef std::vector< SmartPointer< Segment > > gdcm::SegmentReader::SegmentVector
```

## 10.264.3 Constructor & Destructor Documentation

### 10.264.3.1 SegmentReader()

```
gdcm::SegmentReader::SegmentReader ( )
```

### 10.264.3.2 ~SegmentReader()

```
gdcm::SegmentReader::~~SegmentReader ( ) [override]
```

## 10.264.4 Member Function Documentation

### 10.264.4.1 GetSegments() [1/2]

```
SegmentVector gdcm::SegmentReader::GetSegments ( )
```

### 10.264.4.2 GetSegments() [2/2]

```
const SegmentVector gdcm::SegmentReader::GetSegments ( ) const
```

### 10.264.4.3 Read()

```
bool gdcm::SegmentReader::Read ( ) [override], [virtual]
```

Read.

Reimplemented from [gdcm::Reader](#).

Reimplemented in [gdcm::SurfaceReader](#).

### 10.264.4.4 ReadSegment()

```
bool gdcm::SegmentReader::ReadSegment (
    const Item & segmentItem,
    const unsigned int idx ) [protected]
```

### 10.264.4.5 ReadSegments()

```
bool gdcm::SegmentReader::ReadSegments ( ) [protected]
```

## 10.264.5 Member Data Documentation

### 10.264.5.1 Segments

```
SegmentMap gdcm::SegmentReader::Segments [protected]
```

The documentation for this class was generated from the following file:

- [gdcmSegmentReader.h](#)

## 10.265 gdcm::SegmentWriter Class Reference

This class defines a segment writer.

```
#include <gdcmSegmentWriter.h>
```

Inheritance diagram for gdcm::SegmentWriter:

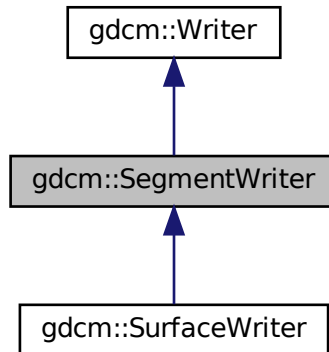

Collaboration diagram for gdcm::SegmentWriter:

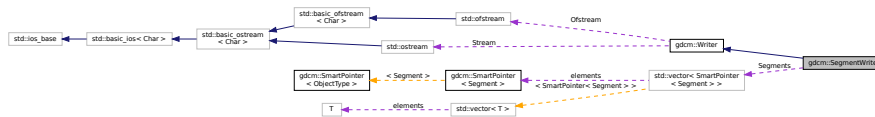

### Public Types

- typedef std::vector< [SmartPointer< Segment >](#) > [SegmentVector](#)

### Public Member Functions

- [SegmentWriter](#) ()
- [~SegmentWriter](#) () override
- void [AddSegment](#) ([SmartPointer< Segment >](#) segment)
- unsigned int [GetNumberOfSegments](#) () const
- [SmartPointer< Segment >](#) [GetSegment](#) (const unsigned int idx=0) const
- [SegmentVector](#) & [GetSegments](#) ()
- const [SegmentVector](#) & [GetSegments](#) () const
- void [SetNumberOfSegments](#) (const unsigned int size)
- void [SetSegments](#) ([SegmentVector](#) &segments)
- bool [Write](#) () override

*Write.*

## Protected Member Functions

- bool [PrepareWrite](#) ()

## Protected Attributes

- [SegmentVector Segments](#)

### 10.265.1 Detailed Description

This class defines a segment writer.

It writes attributes of group 0x0062.

See also

PS 3.3 C.8.20.2 and C.8.23

### 10.265.2 Member Typedef Documentation

#### 10.265.2.1 SegmentVector

```
typedef std::vector< SmartPointer< Segment > > gdcM::SegmentWriter::SegmentVector
```

### 10.265.3 Constructor & Destructor Documentation

#### 10.265.3.1 SegmentWriter()

```
gdcM::SegmentWriter::SegmentWriter ( )
```

#### 10.265.3.2 ~SegmentWriter()

```
gdcM::SegmentWriter::~~SegmentWriter ( ) [override]
```

## 10.265.4 Member Function Documentation

### 10.265.4.1 AddSegment()

```
void gdcm::SegmentWriter::AddSegment (
    SmartPointer< Segment > segment )
```

### 10.265.4.2 GetNumberOfSegments()

```
unsigned int gdcm::SegmentWriter::GetNumberOfSegments ( ) const
```

### 10.265.4.3 GetSegment()

```
SmartPointer< Segment > gdcm::SegmentWriter::GetSegment (
    const unsigned int idx = 0 ) const
```

### 10.265.4.4 GetSegments() [1/2]

```
SegmentVector& gdcm::SegmentWriter::GetSegments ( )
```

### 10.265.4.5 GetSegments() [2/2]

```
const SegmentVector& gdcm::SegmentWriter::GetSegments ( ) const
```

### 10.265.4.6 PrepareWrite()

```
bool gdcm::SegmentWriter::PrepareWrite ( ) [protected]
```

#### 10.265.4.7 SetNumberOfSegments()

```
void gdcM::SegmentWriter::SetNumberOfSegments (
    const unsigned int size )
```

#### 10.265.4.8 SetSegments()

```
void gdcM::SegmentWriter::SetSegments (
    SegmentVector & segments )
```

#### 10.265.4.9 Write()

```
bool gdcM::SegmentWriter::Write ( ) [override], [virtual]
```

Write.

Reimplemented from [gdcM::Writer](#).

Reimplemented in [gdcM::SurfaceWriter](#).

### 10.265.5 Member Data Documentation

#### 10.265.5.1 Segments

```
SegmentVector gdcM::SegmentWriter::Segments [protected]
```

The documentation for this class was generated from the following file:

- [gdcMSegmentWriter.h](#)



## 10.266 gdcM::SequenceOfFragments Class Reference

Class to represent a Sequence Of Fragments.

```
#include <gdcMSequenceOfFragments.h>
```

Inheritance diagram for gdcM::SequenceOfFragments:

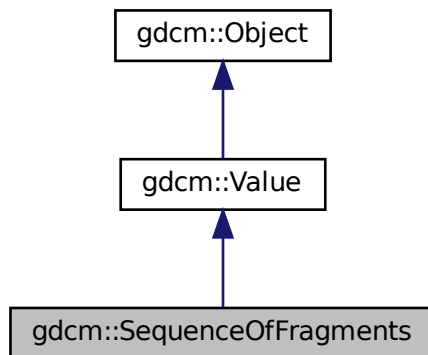

Collaboration diagram for gdcM::SequenceOfFragments:

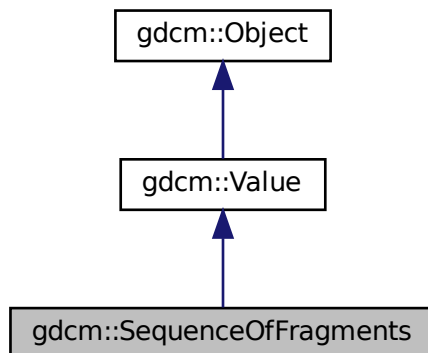

### Public Types

- typedef `FragmentVector::const_iterator` [ConstIterator](#)
- typedef `std::vector< Fragment >` [FragmentVector](#)
- typedef `FragmentVector::iterator` [Iterator](#)
- typedef `FragmentVector::size_type` [SizeType](#)

## Public Member Functions

- [SequenceOfFragments](#) ()  
*constructor (UndefinedLength by default)*
- void [AddFragment](#) ([Fragment](#) const &item)  
*Appends a [Fragment](#) to the already added ones.*
- [Iterator Begin](#) ()
- [ConstIterator Begin](#) () const
- void [Clear](#) () override  
*Clear.*
- unsigned long [ComputeByteLength](#) () const
- [VL ComputeLength](#) () const
- [Iterator End](#) ()
- [ConstIterator End](#) () const
- bool [GetBuffer](#) (char \*buffer, unsigned long length) const
- bool [GetFragBuffer](#) (unsigned int fragNb, char \*buffer, unsigned long &length) const
- const [Fragment](#) & [GetFragment](#) ([SizeType](#) num) const
- [VL GetLength](#) () const override  
*Returns the SQ length, as read from disk.*
- [SizeType GetNumberOfFragments](#) () const
- [BasicOffsetTable](#) & [GetTable](#) ()
- const [BasicOffsetTable](#) & [GetTable](#) () const
- bool [operator==](#) (const [Value](#) &val) const override
- void [Print](#) (std::ostream &os) const override
- template<typename TSwap >  
std::istream & [Read](#) (std::istream &is, bool readvalues=true)
- template<typename TSwap >  
std::istream & [ReadPreValue](#) (std::istream &is)
- template<typename TSwap >  
std::istream & [ReadValue](#) (std::istream &is, bool)
- void [SetLength](#) ([VL](#) length) override  
*Sets the actual SQ length.*
- template<typename TSwap >  
std::ostream const & [Write](#) (std::ostream &os) const
- bool [WriteBuffer](#) (std::ostream &os) const

## Static Public Member Functions

- static [SmartPointer](#)< [SequenceOfFragments](#) > [New](#) ()

## Additional Inherited Members

### 10.266.1 Detailed Description

Class to represent a Sequence Of Fragments.

**Todo** I do not enforce that Sequence of Fragments ends with a SQ end del

#### Examples

[FixBrokenJ2K.cxx](#), [FixJAIBugJPEGLS.cxx](#), and [GetJPEGSamplePrecision.cxx](#).

## 10.266.2 Member Typedef Documentation

### 10.266.2.1 ConstIterator

```
typedef FragmentVector::const_iterator gdcm::SequenceOfFragments::ConstIterator
```

### 10.266.2.2 FragmentVector

```
typedef std::vector<Fragment> gdcm::SequenceOfFragments::FragmentVector
```

### 10.266.2.3 Iterator

```
typedef FragmentVector::iterator gdcm::SequenceOfFragments::Iterator
```

### 10.266.2.4 SizeType

```
typedef FragmentVector::size_type gdcm::SequenceOfFragments::SizeType
```

## 10.266.3 Constructor & Destructor Documentation

### 10.266.3.1 SequenceOfFragments()

```
gdcm::SequenceOfFragments::SequenceOfFragments ( ) [inline]
```

constructor (UndefinedLength by default)

## 10.266.4 Member Function Documentation

#### 10.266.4.1 AddFragment()

```
void gdcM::SequenceOfFragments::AddFragment (
    Fragment const & item )
```

Appends a [Fragment](#) to the already added ones.

#### 10.266.4.2 Begin() [1/2]

```
Iterator gdcM::SequenceOfFragments::Begin ( ) [inline]
```

#### 10.266.4.3 Begin() [2/2]

```
ConstIterator gdcM::SequenceOfFragments::Begin ( ) const [inline]
```

#### 10.266.4.4 Clear()

```
void gdcM::SequenceOfFragments::Clear ( ) [override], [virtual]
```

Clear.

Implements [gdcM::Value](#).

#### 10.266.4.5 ComputeByteLength()

```
unsigned long gdcM::SequenceOfFragments::ComputeByteLength ( ) const
```

#### 10.266.4.6 ComputeLength()

```
VL gdcM::SequenceOfFragments::ComputeLength ( ) const
```

#### 10.266.4.7 End() [1/2]

```
Iterator gdcm::SequenceOfFragments::End ( ) [inline]
```

#### 10.266.4.8 End() [2/2]

```
ConstIterator gdcm::SequenceOfFragments::End ( ) const [inline]
```

#### 10.266.4.9 GetBuffer()

```
bool gdcm::SequenceOfFragments::GetBuffer (
    char * buffer,
    unsigned long length ) const
```

#### 10.266.4.10 GetFragBuffer()

```
bool gdcm::SequenceOfFragments::GetFragBuffer (
    unsigned int fragNb,
    char * buffer,
    unsigned long & length ) const
```

#### 10.266.4.11 GetFragment()

```
const Fragment& gdcm::SequenceOfFragments::GetFragment (
    SizeType num ) const
```

#### Examples

[FixBrokenJ2K.cxx](#), and [FixJAIBugJPEGLS.cxx](#).

#### 10.266.4.12 GetLength()

```
VL gdcM::SequenceOfFragments::GetLength ( ) const [inline], [override], [virtual]
```

Returns the SQ length, as read from disk.

Implements [gdcM::Value](#).

#### 10.266.4.13 GetNumberOfFragments()

```
SizeType gdcM::SequenceOfFragments::GetNumberOfFragments ( ) const
```

##### Examples

[FixJAIBugJPEGLS.cxx](#).

#### 10.266.4.14 GetTable() [1/2]

```
BasicOffsetTable& gdcM::SequenceOfFragments::GetTable ( ) [inline]
```

#### 10.266.4.15 GetTable() [2/2]

```
const BasicOffsetTable& gdcM::SequenceOfFragments::GetTable ( ) const [inline]
```

#### 10.266.4.16 New()

```
static SmartPointer<SequenceOfFragments> gdcM::SequenceOfFragments::New ( ) [inline], [static]
```

#### 10.266.4.17 operator==( )

```
bool gdcM::SequenceOfFragments::operator==( (
    const Value & val ) const [inline], [override], [virtual]
```

Implements [gdcM::Value](#).

#### 10.266.4.18 Print()

```
void gdcM::SequenceOfFragments::Print (
    std::ostream & os ) const [inline], [override], [virtual]
```

Reimplemented from [gdcM::Object](#).

#### 10.266.4.19 Read()

```
template<typename TSwap >
std::istream& gdcM::SequenceOfFragments::Read (
    std::istream & is,
    bool readvalues = true ) [inline]
```

#### 10.266.4.20 ReadPreValue()

```
template<typename TSwap >
std::istream& gdcM::SequenceOfFragments::ReadPreValue (
    std::istream & is ) [inline]
```

References [gdcMDebugMacro](#).

#### 10.266.4.21 ReadValue()

```
template<typename TSwap >
std::istream& gdcM::SequenceOfFragments::ReadValue (
    std::istream & is,
    bool ) [inline]
```

References [gdcMAssertAlwaysMacro](#), [gdcMDebugMacro](#), [gdcMWarningMacro](#), [gdcM::Tag::GetElement\(\)](#), [gdcM::Tag::GetGroup\(\)](#), [gdcM::ByteValue::GetLength\(\)](#), [gdcM::ByteValue::GetPointer\(\)](#), [gdcM::DataElement::GetTag\(\)](#), [gdcM::DataElement::GetVL\(\)](#), [gdcM::Fragment::Read\(\)](#), [gdcM::Fragment::ReadBacktrack\(\)](#), and [gdcM::Exception::what\(\)](#).

#### 10.266.4.22 SetLength()

```
void gdcM::SequenceOfFragments::SetLength (
    VL length ) [inline], [override], [virtual]
```

Sets the actual SQ length.

Implements [gdcM::Value](#).

### 10.266.4.23 Write()

```
template<typename TSwap >
std::ostream const& gdcM::SequenceOfFragments::Write (
    std::ostream & os ) const [inline]
```

References `gdcM::Tag::Write()`, and `gdcM::VL::Write()`.

### 10.266.4.24 WriteBuffer()

```
bool gdcM::SequenceOfFragments::WriteBuffer (
    std::ostream & os ) const
```

#### Examples

[GetJPEGSamplePrecision.cxx](#).

The documentation for this class was generated from the following file:

- [gdcMSequenceOfFragments.h](#)

## 10.267 gdcM::SequenceOfItems Class Reference

Class to represent a Sequence Of Items.

```
#include <gdcMSequenceOfItems.h>
```

Inheritance diagram for `gdcM::SequenceOfItems`:

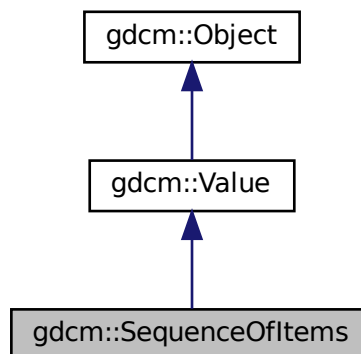



Collaboration diagram for gdcM::SequenceOfItems:

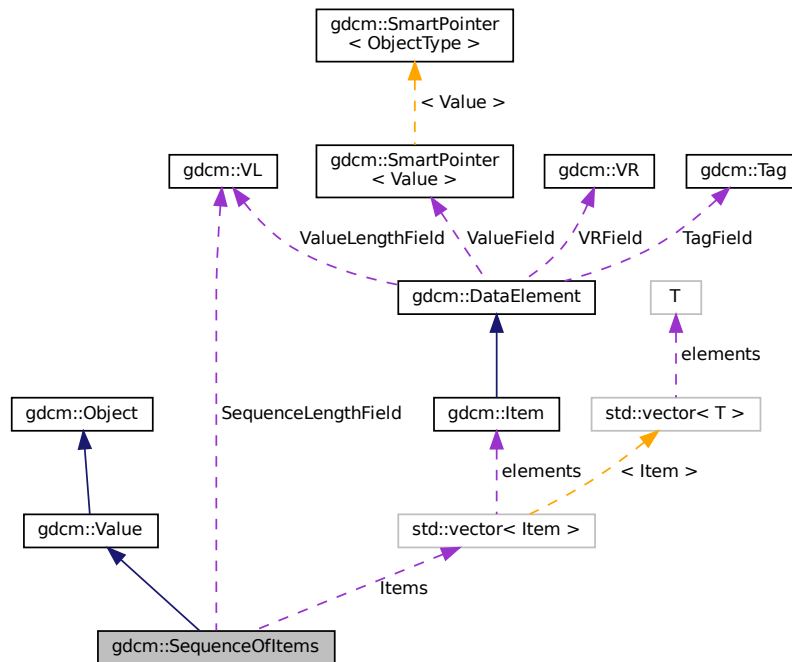

## Public Types

- typedef `ItemVector::const_iterator` [ConstIterator](#)
- typedef `std::vector< Item >` [ItemVector](#)
- typedef `ItemVector::iterator` [Iterator](#)
- typedef `ItemVector::size_type` [SizeType](#)

## Public Member Functions

- [SequenceOfItems](#) ()  
*constructor (UndefinedLength by default)*
- void [AddItem](#) (Item const &item)  
*Appends an Item to the already added ones.*
- Item & [AddNewUndefinedLengthItem](#) ()  
*Appends an Item to the already added ones.*
- [Iterator](#) [Begin](#) ()
- [ConstIterator](#) [Begin](#) () const
- void [Clear](#) () override  
*remove all items within the sequence*
- template<typename TDE >  
[VL ComputeLength](#) () const

- [Iterator End](#) ()
- [ConstIterator End](#) () const
- bool [FindDataElement](#) (const [Tag](#) &t) const
- [Item](#) & [GetItem](#) ([SizeType](#) position)
- const [Item](#) & [GetItem](#) ([SizeType](#) position) const
- [VL GetLength](#) () const override
  - Returns the SQ length, as read from disk.*
- [SizeType GetNumberOfItems](#) () const
- bool [IsEmpty](#) () const
- bool [IsUndefinedLength](#) () const
  - return if [Value](#) Length if of undefined length*
- [SequenceOfItems](#) & [operator=](#) (const [SequenceOfItems](#) &val)
- bool [operator==](#) (const [Value](#) &val) const override
- void [Print](#) (std::ostream &os) const override
- template<typename TDE , typename TSwap >  
std::istream & [Read](#) (std::istream &is, bool readvalues=true)
- bool [RemoveItemByIndex](#) (const [SizeType](#) index)
- void [SetLength](#) ([VL](#) length) override
  - Sets the actual SQ length.*
- void [SetLengthToUndefined](#) ()
  - Properly set the Sequence of [Item](#) to be undefined length.*
- void [SetNumberOfItems](#) ([SizeType](#) n)
- template<typename TDE , typename TSwap >  
std::ostream const & [Write](#) (std::ostream &os) const

## Static Public Member Functions

- static [SmartPointer](#)< [SequenceOfItems](#) > [New](#) ()

## Public Attributes

- [ItemVector](#) [Items](#)
  - Vector of Sequence Items.*
- [VL](#) [SequenceLengthField](#)
  - Total length of the Sequence (or 0xffffffff) if undefined.*

## Additional Inherited Members

### 10.267.1 Detailed Description

Class to represent a Sequence Of Items.

(value representation : SQ)

- a [Value](#) Representation for Data Elements that contains a sequence of Data Sets.
- Sequence of [Item](#) allows for Nested Data Sets

See PS 3.5, 7.4.6 Data [Element Type](#) Within a Sequence

**Note**

SEQUENCE OF ITEMS (VALUE REPRESENTATION SQ) A [Value](#) Representation for Data Elements that contain a sequence of Data Sets. Sequence of Items allows for Nested Data Sets.

**Examples**

[DumpExamCard.cxx](#), [DumpGEMSMovieGroup.cxx](#), [ExtractEncryptedContent.cxx](#), [Extracting\\_All\\_Resolution.cxx](#), [Fake\\_Image\\_Using\\_Stream\\_Image\\_Writer.cxx](#), [GenAllVR.cxx](#), [GenFakeIdentifyFile.cxx](#), [GenLongSeqs.cxx](#), [GenSeqs.cxx](#), and [GetSequenceUltrasound.cxx](#).

## 10.267.2 Member Typedef Documentation

### 10.267.2.1 ConstIterator

```
typedef ItemVector::const_iterator gdcm::SequenceOfItems::ConstIterator
```

### 10.267.2.2 ItemVector

```
typedef std::vector< Item > gdcm::SequenceOfItems::ItemVector
```

### 10.267.2.3 Iterator

```
typedef ItemVector::iterator gdcm::SequenceOfItems::Iterator
```

### 10.267.2.4 SizeType

```
typedef ItemVector::size_type gdcm::SequenceOfItems::SizeType
```

**Examples**

[DumpGEMSMovieGroup.cxx](#).

## 10.267.3 Constructor & Destructor Documentation

### 10.267.3.1 SequenceOfItems()

```
gdcM::SequenceOfItems::SequenceOfItems ( ) [inline]
```

constructor (UndefinedLength by default)

## 10.267.4 Member Function Documentation

### 10.267.4.1 AddItem()

```
void gdcM::SequenceOfItems::AddItem (
    Item const & item )
```

Appends an [Item](#) to the already added ones.

#### Examples

[Extracting\\_All\\_Resolution.cxx](#).

### 10.267.4.2 AddNewUndefinedLengthItem()

```
Item& gdcM::SequenceOfItems::AddNewUndefinedLengthItem ( )
```

Appends an [Item](#) to the already added ones.

### 10.267.4.3 Begin() [1/2]

```
Iterator gdcM::SequenceOfItems::Begin ( ) [inline]
```

### 10.267.4.4 Begin() [2/2]

```
ConstIterator gdcM::SequenceOfItems::Begin ( ) const [inline]
```

#### 10.267.4.5 Clear()

```
void gdcM::SequenceOfItems::Clear ( ) [override], [virtual]
```

remove all items within the sequence

Implements [gdcM::Value](#).

#### 10.267.4.6 ComputeLength()

```
template<typename TDE >  
VL gdcM::SequenceOfItems::ComputeLength ( ) const
```

#### 10.267.4.7 End() [1/2]

```
Iterator gdcM::SequenceOfItems::End ( ) [inline]
```

#### 10.267.4.8 End() [2/2]

```
ConstIterator gdcM::SequenceOfItems::End ( ) const [inline]
```

#### 10.267.4.9 FindDataElement()

```
bool gdcM::SequenceOfItems::FindDataElement (   
    const Tag & t ) const
```

#### 10.267.4.10 GetItem() [1/2]

```
Item& gdcM::SequenceOfItems::GetItem (   
    SizeType position )
```

#### 10.267.4.11 GetItem() [2/2]

```
const Item& gdcM::SequenceOfItems::GetItem (
    SizeType position ) const
```

##### Examples

[DumpExamCard.cxx](#), [DumpGEMSMovieGroup.cxx](#), [ExtractEncryptedContent.cxx](#), and [GetSequenceUltrasound.cxx](#).

#### 10.267.4.12 GetLength()

```
VL gdcM::SequenceOfItems::GetLength ( ) const [inline], [override], [virtual]
```

Returns the SQ length, as read from disk.

Implements [gdcM::Value](#).

#### 10.267.4.13 GetNumberOfItems()

```
SizeType gdcM::SequenceOfItems::GetNumberOfItems ( ) const [inline]
```

##### Examples

[DumpExamCard.cxx](#), [DumpGEMSMovieGroup.cxx](#), [ExtractEncryptedContent.cxx](#), and [GetSequenceUltrasound.cxx](#).

#### 10.267.4.14 IsEmpty()

```
bool gdcM::SequenceOfItems::IsEmpty ( ) const [inline]
```

#### 10.267.4.15 IsUndefinedLength()

```
bool gdcM::SequenceOfItems::IsUndefinedLength ( ) const [inline]
```

return if [Value](#) Length if of undefined length

### 10.267.4.16 New()

```
static SmartPointer<SequenceOfItems> gdcM::SequenceOfItems::New ( ) [inline], [static]
```

#### Examples

[NewSequence.cs](#).

### 10.267.4.17 operator=()

```
SequenceOfItems& gdcM::SequenceOfItems::operator= (
    const SequenceOfItems & val ) [inline]
```

References [Items](#), and [SequenceLengthField](#).

### 10.267.4.18 operator==( )

```
bool gdcM::SequenceOfItems::operator== (
    const Value & val ) const [inline], [override], [virtual]
```

Implements [gdcM::Value](#).

References [Items](#), and [SequenceLengthField](#).

### 10.267.4.19 Print()

```
void gdcM::SequenceOfItems::Print (
    std::ostream & os ) const [inline], [override], [virtual]
```

Reimplemented from [gdcM::Object](#).

### 10.267.4.20 Read()

```
template<typename TDE , typename TSwap >
std::istream& gdcM::SequenceOfItems::Read (
    std::istream & is,
    bool readvalues = true ) [inline]
```

References [gdcM::Item::Clear\(\)](#), [gdcMDebugMacro](#), [gdcMWarningMacro](#), [gdcM::Exception::GetDescription\(\)](#), [gdcM::Item::GetNestedDataSet\(\)](#), [gdcM::DataElement::GetTag\(\)](#), [gdcM::DataElement::GetVL\(\)](#), [gdcM::Item::Read\(\)](#), and [gdcM::DataSet::Size\(\)](#).

#### 10.267.4.21 RemoveItemByIndex()

```
bool gdcM::SequenceOfItems::RemoveItemByIndex (
    const SizeType index )
```

Remove an [Item](#) as specified by its index, if index > size, false is returned Index starts at 1 not 0

#### 10.267.4.22 SetLength()

```
void gdcM::SequenceOfItems::SetLength (
    VL length ) [inline], [override], [virtual]
```

Sets the actual SQ length.

Implements [gdcM::Value](#).

#### 10.267.4.23 SetLengthToUndefined()

```
void gdcM::SequenceOfItems::SetLengthToUndefined ( )
```

Properly set the Sequence of [Item](#) to be undefined length.

#### 10.267.4.24 SetNumberOfItems()

```
void gdcM::SequenceOfItems::SetNumberOfItems (
    SizeType n ) [inline]
```

#### 10.267.4.25 Write()

```
template<typename TDE , typename TSwap >
std::ostream const& gdcM::SequenceOfItems::Write (
    std::ostream & os ) const [inline]
```

References [gdcM::Tag::Write\(\)](#), and [gdcM::VL::Write\(\)](#).

### 10.267.5 Member Data Documentation



### 10.267.5.1 Items

`ItemVector` `gdcM::SequenceOfItems::Items`

Vector of Sequence Items.

Referenced by `operator=()`, and `operator==()`.

### 10.267.5.2 SequenceLengthField

`VL` `gdcM::SequenceOfItems::SequenceLengthField`

Total length of the Sequence (or `0xffffffff`) if undefined.

Referenced by `operator=()`, and `operator==()`.

The documentation for this class was generated from the following file:

- [gdcMSequenceOfItems.h](#)

## 10.268 gdcM::SerieHelper Class Reference

`SerieHelper` DO NOT USE this class, it is only a temporary solution for ITK migration from GDCM 1.x to GDCM 2.x It will disappear soon, you've been warned.

```
#include <gdcMSerieHelper.h>
```

Collaboration diagram for `gdcM::SerieHelper`:

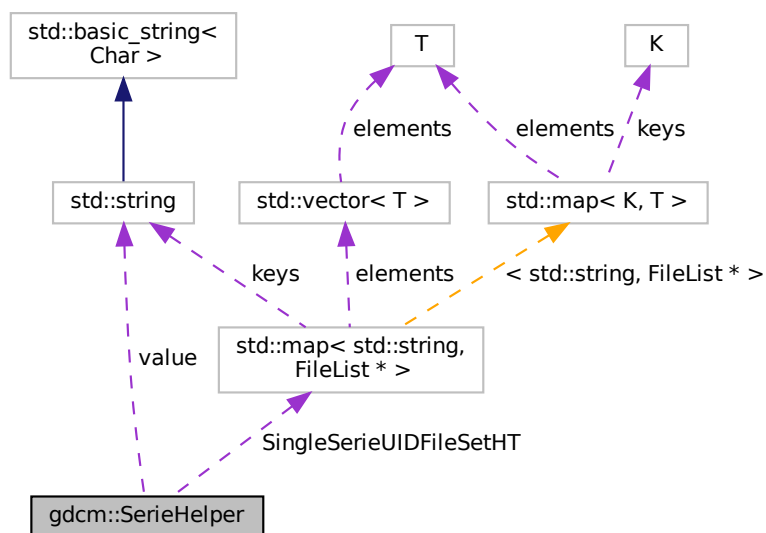

## Public Member Functions

- [SerieHelper](#) ()
- [~SerieHelper](#) ()
- void [AddRestriction](#) (const std::string &tag)
- void [AddRestriction](#) (uint16\_t group, uint16\_t elem, std::string const &value, int op)
- void [Clear](#) ()
- void [CreateDefaultUniqueSeriesIdentifier](#) ()
- std::string [CreateUniqueSeriesIdentifier](#) (File \*inFile)
- [FileList](#) \* [GetFirstSingleSerieUIDFileSet](#) ()
- [FileList](#) \* [GetNextSingleSerieUIDFileSet](#) ()
- void [OrderFileList](#) ([FileList](#) \*fileSet)
- void [SetDirectory](#) (std::string const &dir, bool recursive=false)
- void [SetLoadMode](#) (int)
- void [SetUseSeriesDetails](#) (bool useSeriesDetails)

## Protected Types

- using [Rule](#) = struct RuleStructure{ uint16\_t group
- typedef std::vector< [Rule](#) > [SerieRestrictions](#)
- typedef std::map< std::string, [FileList](#) \* > [SingleSerieUIDFileSetmap](#)

## Protected Member Functions

- bool [AddFile](#) ([FileWithName](#) &header)
- void [AddFileName](#) (std::string const &filename)
- void [AddRestriction](#) (const [Tag](#) &tag)
- bool [FileNameOrdering](#) ([FileList](#) \*fileList)
- bool [ImageNumberOrdering](#) ([FileList](#) \*fileList)
- bool [ImagePositionPatientOrdering](#) ([FileList](#) \*fileSet)
- bool [UserOrdering](#) ([FileList](#) \*fileSet)

## Protected Attributes

- uint16\_t [elem](#)
- [SingleSerieUIDFileSetmap::iterator](#) [ItFileSetHt](#)
- int [op](#)
- [SingleSerieUIDFileSetmap](#) [SingleSerieUIDFileSetHT](#)
- std::string [value](#)

### 10.268.1 Detailed Description

[SerieHelper](#) DO NOT USE this class, it is only a temporary solution for ITK migration from GDCM 1.x to GDCM 2.x It will disappear soon, you've been warned.

Instead see [ImageHelper](#) or [IPPSorter](#)

## 10.268.2 Member Typedef Documentation

### 10.268.2.1 Rule

```
using gdcm::SerieHelper::Rule = struct RuleStructure{ uint16_t group [protected]
```

### 10.268.2.2 SerieRestrictions

```
typedef std::vector<Rule> gdcm::SerieHelper::SerieRestrictions [protected]
```

### 10.268.2.3 SingleSerieUIDFileSetmap

```
typedef std::map<std::string, FileList *> gdcm::SerieHelper::SingleSerieUIDFileSetmap [protected]
```

## 10.268.3 Constructor & Destructor Documentation

### 10.268.3.1 SerieHelper()

```
gdcm::SerieHelper::SerieHelper ( )
```

### 10.268.3.2 ~SerieHelper()

```
gdcm::SerieHelper::~~SerieHelper ( )
```

## 10.268.4 Member Function Documentation

#### 10.268.4.1 AddFile()

```
bool gdcM::SerieHelper::AddFile (
    FileWithName & header ) [protected]
```

#### 10.268.4.2 AddFileName()

```
void gdcM::SerieHelper::AddFileName (
    std::string const & filename ) [protected]
```

#### 10.268.4.3 AddRestriction() [1/3]

```
void gdcM::SerieHelper::AddRestriction (
    const std::string & tag )
```

#### 10.268.4.4 AddRestriction() [2/3]

```
void gdcM::SerieHelper::AddRestriction (
    const Tag & tag ) [protected]
```

#### 10.268.4.5 AddRestriction() [3/3]

```
void gdcM::SerieHelper::AddRestriction (
    uint16_t group,
    uint16_t elem,
    std::string const & value,
    int op )
```

#### 10.268.4.6 Clear()

```
void gdcM::SerieHelper::Clear ( )
```

#### 10.268.4.7 CreateDefaultUniqueSeriesIdentifier()

```
void gdcm::SerieHelper::CreateDefaultUniqueSeriesIdentifier ( )
```

#### 10.268.4.8 CreateUniqueSeriesIdentifier()

```
std::string gdcm::SerieHelper::CreateUniqueSeriesIdentifier (
    File * inFile )
```

#### 10.268.4.9 FileNameOrdering()

```
bool gdcm::SerieHelper::FileNameOrdering (
    FileList * fileList ) [protected]
```

#### 10.268.4.10 GetFirstSingleSerieUIDFileSet()

```
FileList* gdcm::SerieHelper::GetFirstSingleSerieUIDFileSet ( )
```

#### 10.268.4.11 GetNextSingleSerieUIDFileSet()

```
FileList* gdcm::SerieHelper::GetNextSingleSerieUIDFileSet ( )
```

#### 10.268.4.12 ImageNumberOrdering()

```
bool gdcm::SerieHelper::ImageNumberOrdering (
    FileList * fileList ) [protected]
```

#### 10.268.4.13 ImagePositionPatientOrdering()

```
bool gdcm::SerieHelper::ImagePositionPatientOrdering (
    FileList * fileSet ) [protected]
```

#### 10.268.4.14 OrderFileList()

```
void gdcM::SerieHelper::OrderFileList (
    FileList * fileSet )
```

#### 10.268.4.15 SetDirectory()

```
void gdcM::SerieHelper::SetDirectory (
    std::string const & dir,
    bool recursive = false )
```

#### 10.268.4.16 SetLoadMode()

```
void gdcM::SerieHelper::SetLoadMode (
    int ) [inline]
```

#### 10.268.4.17 SetUseSeriesDetails()

```
void gdcM::SerieHelper::SetUseSeriesDetails (
    bool useSeriesDetails )
```

#### 10.268.4.18 UserOrdering()

```
bool gdcM::SerieHelper::UserOrdering (
    FileList * fileSet ) [protected]
```

### 10.268.5 Member Data Documentation

#### 10.268.5.1 elem

```
uint16_t gdcM::SerieHelper::elem [protected]
```

### 10.268.5.2 ItFileSetHt

```
SingleSerieUIDFileSetmap::iterator gdcM::SerieHelper::ItFileSetHt [protected]
```

### 10.268.5.3 op

```
int gdcM::SerieHelper::op [protected]
```

### 10.268.5.4 SingleSerieUIDFileSetHT

```
SingleSerieUIDFileSetmap gdcM::SerieHelper::SingleSerieUIDFileSetHT [protected]
```

### 10.268.5.5 value

```
std::string gdcM::SerieHelper::value [protected]
```

The documentation for this class was generated from the following file:

- [gdcMSerieHelper.h](#)

## 10.269 gdcM::Series Class Reference

[Series.](#)

```
#include <gdcMSeries.h>
```

### Public Member Functions

- [Series](#) ()=default

### 10.269.1 Detailed Description

[Series.](#)

## 10.269.2 Constructor & Destructor Documentation

### 10.269.2.1 Series()

```
gdcm::Series::Series ( ) [default]
```

The documentation for this class was generated from the following file:

- [gdcmSeries.h](#)

## 10.270 gdcm::network::ServiceClassApplicationInformation Class Reference

```
#include <gdcmServiceClassApplicationInformation.h>
```

### Public Member Functions

- [ServiceClassApplicationInformation](#) ()
- void [Print](#) (std::ostream &os) const
- std::istream & [Read](#) (std::istream &is)
- void [SetTuple](#) (uint8\_t levelofsupport, uint8\_t levelofdigitalsig, uint8\_t elementcoercion)
- size\_t [Size](#) () const
- const std::ostream & [Write](#) (std::ostream &os) const

### 10.270.1 Detailed Description

PS 3.4 [Table B.3-1](#) SERVICE-CLASS-APPLICATION-INFORMATION (A-ASSOCIATE-RQ)

## 10.270.2 Constructor & Destructor Documentation

### 10.270.2.1 ServiceClassApplicationInformation()

```
gdcm::network::ServiceClassApplicationInformation::ServiceClassApplicationInformation ( )
```



## 10.270.3 Member Function Documentation

### 10.270.3.1 Print()

```
void gdcm::network::ServiceClassApplicationInformation::Print (
    std::ostream & os ) const
```

### 10.270.3.2 Read()

```
std::istream& gdcm::network::ServiceClassApplicationInformation::Read (
    std::istream & is )
```

### 10.270.3.3 SetTuple()

```
void gdcm::network::ServiceClassApplicationInformation::SetTuple (
    uint8_t levelofsupport,
    uint8_t levelofdigitalsig,
    uint8_t elementcoercion )
```

### 10.270.3.4 Size()

```
size_t gdcm::network::ServiceClassApplicationInformation::Size ( ) const
```

### 10.270.3.5 Write()

```
const std::ostream& gdcm::network::ServiceClassApplicationInformation::Write (
    std::ostream & os ) const
```

The documentation for this class was generated from the following file:

- [gdcmServiceClassApplicationInformation.h](#)

## 10.271 gdcM::ServiceClassUser Class Reference

[ServiceClassUser](#).

```
#include <gdcMServiceClassUser.h>
```

Inheritance diagram for gdcM::ServiceClassUser:

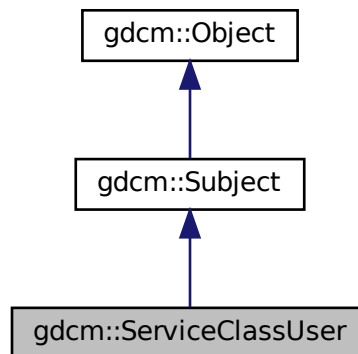

Collaboration diagram for gdcM::ServiceClassUser:

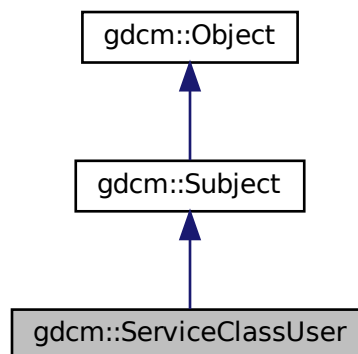

## Public Member Functions

- [ServiceClassUser](#) ()
- [ServiceClassUser](#) (const [ServiceClassUser](#) &)=delete
- [~ServiceClassUser](#) () override
- const char \* [GetAETitle](#) () const
- const char \* [GetCalledAETitle](#) () const
- double [GetTimeout](#) () const
- bool [InitializeConnection](#) ()
- bool [IsPresentationContextAccepted](#) (const [PresentationContext](#) &pc) const  
*Return if the passed in presentation was accepted during association negotiation.*
- void [operator=](#) (const [ServiceClassUser](#) &)=delete
- bool [SendEcho](#) ()  
*C-ECHO.*
- bool [SendFind](#) (const [BaseRootQuery](#) \*query, std::vector< [DataSet](#) > &retDatasets)  
*C-FIND a query, return result are in retDatasets.*
- bool [SendMove](#) (const [BaseRootQuery](#) \*query, const char \*outputdir)  
*Execute a C-MOVE, based on query, return files are written in outputdir.*
- bool [SendMove](#) (const [BaseRootQuery](#) \*query, std::vector< [DataSet](#) > &retDatasets)  
*Execute a C-MOVE, based on query, returned dataset are Implicit.*
- bool [SendMove](#) (const [BaseRootQuery](#) \*query, std::vector< [File](#) > &retFile)  
*Execute a C-MOVE, based on query, returned Files are stored in vector.*
- bool [SendStore](#) (const char \*filename)  
*Execute a C-STORE on file on disk, named filename.*
- bool [SendStore](#) ([DataSet](#) const &ds)  
*Execute a C-STORE on a DataSet, the transfer syntax used will be Implicit.*
- bool [SendStore](#) ([File](#) const &file)
- void [SetAETitle](#) (const char \*aetitle)  
*set calling ae title*
- void [SetCalledAETitle](#) (const char \*aetitle)  
*set called ae title*
- void [SetHostname](#) (const char \*hostname)  
*Set the name of the called hostname (hostname or IP address)*
- void [SetPort](#) (uint16\_t port)  
*Set port of remote host (called application)*
- void [SetPortSCP](#) (uint16\_t portscp)  
*Set the port for any incoming C-STORE-SCP operation (typically in a return of C-MOVE)*
- void [SetPresentationContexts](#) (std::vector< [PresentationContext](#) > const &pcs)  
*Set the Presentation Context used for the Association.*
- void [SetTimeout](#) (double t)  
*set/get Timeout*
- bool [StartAssociation](#) ()  
*Start the association. Need to call SetPresentationContexts before.*
- bool [StopAssociation](#) ()  
*Stop the running association.*

## Static Public Member Functions

- static [SmartPointer](#)< [ServiceClassUser](#) > [New](#) ()  
*for wrapped language: instantiate a reference counted object*

## Additional Inherited Members

### 10.271.1 Detailed Description

[ServiceClassUser](#).

Examples

[CStoreQtProgress.cxx](#).

### 10.271.2 Constructor & Destructor Documentation

#### 10.271.2.1 [ServiceClassUser](#)() [1/2]

```
gdcmm::ServiceClassUser::ServiceClassUser ( )
```

Construct a SCU with default:

- hostname = localhost
- port = 104

#### 10.271.2.2 [~ServiceClassUser](#)()

```
gdcmm::ServiceClassUser::~~ServiceClassUser ( ) [override]
```

#### 10.271.2.3 [ServiceClassUser](#)() [2/2]

```
gdcmm::ServiceClassUser::ServiceClassUser (
    const ServiceClassUser & ) [delete]
```

## 10.271.3 Member Function Documentation

### 10.271.3.1 GetAETitle()

```
const char* gdcM::ServiceClassUser::GetAETitle ( ) const
```

### 10.271.3.2 GetCalledAETitle()

```
const char* gdcM::ServiceClassUser::GetCalledAETitle ( ) const
```

### 10.271.3.3 GetTimeout()

```
double gdcM::ServiceClassUser::GetTimeout ( ) const
```

### 10.271.3.4 InitializeConnection()

```
bool gdcM::ServiceClassUser::InitializeConnection ( )
```

Will try to connect This will setup the actual timeout used during the whole connection time. Need to call SetTimeout first

#### Examples

[CStoreQtProgress.cxx](#).

### 10.271.3.5 IsPresentationContextAccepted()

```
bool gdcM::ServiceClassUser::IsPresentationContextAccepted (
    const PresentationContext & pc ) const
```

Return if the passed in presentation was accepted during association negotiation.

### 10.271.3.6 New()

```
static SmartPointer<ServiceClassUser> gdcM::ServiceClassUser::New ( ) [inline], [static]
```

for wrapped language: instantiate a reference counted object

### 10.271.3.7 operator=()

```
void gdcM::ServiceClassUser::operator= (
    const ServiceClassUser & ) [delete]
```

### 10.271.3.8 SendEcho()

```
bool gdcM::ServiceClassUser::SendEcho ( )
```

C-ECHO.

### 10.271.3.9 SendFind()

```
bool gdcM::ServiceClassUser::SendFind (
    const BaseRootQuery * query,
    std::vector< DataSet > & retDatasets )
```

C-FIND a query, return result are in retDatasets.

### 10.271.3.10 SendMove() [1/3]

```
bool gdcM::ServiceClassUser::SendMove (
    const BaseRootQuery * query,
    const char * outputdir )
```

Execute a C-MOVE, based on query, return files are written in outputdir.

**10.271.3.11 SendMove()** [2/3]

```
bool gdcM::ServiceClassUser::SendMove (
    const BaseRootQuery * query,
    std::vector< DataSet > & retDatasets )
```

Execute a C-MOVE, based on query, returned dataset are Implicit.

**10.271.3.12 SendMove()** [3/3]

```
bool gdcM::ServiceClassUser::SendMove (
    const BaseRootQuery * query,
    std::vector< File > & retFile )
```

Execute a C-MOVE, based on query, returned Files are stored in vector.

**10.271.3.13 SendStore()** [1/3]

```
bool gdcM::ServiceClassUser::SendStore (
    const char * filename )
```

Execute a C-STORE on file on disk, named filename.

**Examples**

[CStoreQtProgress.cxx](#).

**10.271.3.14 SendStore()** [2/3]

```
bool gdcM::ServiceClassUser::SendStore (
    DataSet const & ds )
```

Execute a C-STORE on a [DataSet](#), the transfer syntax used will be Implicit.

**10.271.3.15 SendStore()** [3/3]

```
bool gdcM::ServiceClassUser::SendStore (
    File const & file )
```

Execute a C-STORE on a [File](#), the transfer syntax used for the query is based on the file.

### 10.271.3.16 SetAETitle()

```
void gdcM::ServiceClassUser::SetAETitle (
    const char * aetitle )
```

set calling ae title

### 10.271.3.17 SetCalledAETitle()

```
void gdcM::ServiceClassUser::SetCalledAETitle (
    const char * aetitle )
```

set called ae title

#### Examples

[CStoreQtProgress.cxx](#).

### 10.271.3.18 SetHostname()

```
void gdcM::ServiceClassUser::SetHostname (
    const char * hostname )
```

Set the name of the called hostname (hostname or IP address)

#### Examples

[CStoreQtProgress.cxx](#).

### 10.271.3.19 SetPort()

```
void gdcM::ServiceClassUser::SetPort (
    uint16_t port )
```

Set port of remote host (called application)

#### Examples

[CStoreQtProgress.cxx](#).



### 10.271.3.20 SetPortSCP()

```
void gdcm::ServiceClassUser::SetPortSCP (
    uint16_t portscp )
```

Set the port for any incoming C-STORE-SCP operation (typically in a return of C-MOVE)

### 10.271.3.21 SetPresentationContexts()

```
void gdcm::ServiceClassUser::SetPresentationContexts (
    std::vector< PresentationContext > const & pcs )
```

Set the Presentation Context used for the Association.

#### Examples

[CStoreQtProgress.cxx](#).

### 10.271.3.22 SetTimeout()

```
void gdcm::ServiceClassUser::SetTimeout (
    double t )
```

set/get Timeout

#### Examples

[CStoreQtProgress.cxx](#).

### 10.271.3.23 StartAssociation()

```
bool gdcm::ServiceClassUser::StartAssociation ( )
```

Start the association. Need to call SetPresentationContexts before.

#### Examples

[CStoreQtProgress.cxx](#).

### 10.271.3.24 StopAssociation()

```
bool gdcm::ServiceClassUser::StopAssociation ( )
```

Stop the running association.

#### Examples

[CStoreQtProgress.cxx](#).

The documentation for this class was generated from the following file:

- [gdcmServiceClassUser.h](#)

## 10.272 gdcm::SHA1 Class Reference

Class for [SHA1](#).

```
#include <gdcmSHA1.h>
```

### Public Member Functions

- [SHA1](#) ()
- [SHA1](#) (const [SHA1](#) &)=delete
- [~SHA1](#) ()
- void [operator=](#) (const [SHA1](#) &)=delete

### Static Public Member Functions

- static bool [Compute](#) (const char \*buffer, unsigned long buf\_len, char digest\_str[20 \*2+1])
- static bool [ComputeFile](#) (const char \*filename, char digest\_str[20 \*2+1])

### 10.272.1 Detailed Description

Class for [SHA1](#).

#### Warning

this class is able to pick from one implementation:

1. the one from OpenSSL (when GDCM\_USE\_SYSTEM\_OPENSSL is turned ON)

In all other cases it will return an error

## 10.272.2 Constructor & Destructor Documentation

### 10.272.2.1 SHA1() [1/2]

```
gdcM::SHA1::SHA1 ( )
```

### 10.272.2.2 ~SHA1()

```
gdcM::SHA1::~~SHA1 ( )
```

### 10.272.2.3 SHA1() [2/2]

```
gdcM::SHA1::SHA1 (
    const SHA1 & ) [delete]
```

## 10.272.3 Member Function Documentation

### 10.272.3.1 Compute()

```
static bool gdcM::SHA1::Compute (
    const char * buffer,
    unsigned long buf_len,
    char digest_str[20 *2+1] ) [static]
```

### 10.272.3.2 ComputeFile()

```
static bool gdcM::SHA1::ComputeFile (
    const char * filename,
    char digest_str[20 *2+1] ) [static]
```

### 10.272.3.3 operator=()

```
void gdcM::SHA1::operator= (
    const SHA1 & ) [delete]
```

The documentation for this class was generated from the following file:

- [gdcMSHA1.h](#)

## 10.273 gdcM::SimpleMemberCommand< T > Class Template Reference

[Command](#) subclass that calls a pointer to a member function.

```
#include <gdcMCommand.h>
```

Inheritance diagram for gdcM::SimpleMemberCommand< T >:

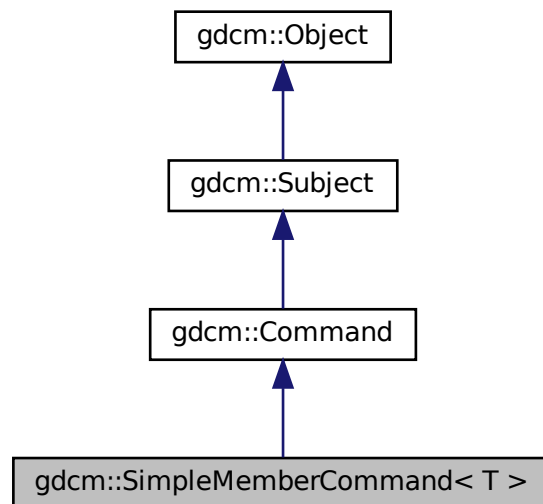

Collaboration diagram for gdcM::SimpleMemberCommand< T >:

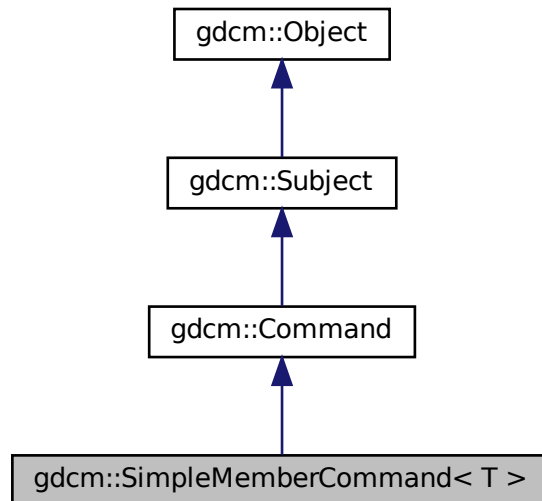

## Public Types

- typedef [SimpleMemberCommand](#) Self
- typedef void(T::\* TMemberFunctionPointer) ()

## Public Member Functions

- [SimpleMemberCommand](#) (const Self &)=delete
- void [Execute](#) (const Subject \*, const Event &) override
- void [Execute](#) (Subject \*, const Event &) override
- void [operator=](#) (const Self &)=delete
- void [SetCallbackFunction](#) (T \*object, TMemberFunctionPointer memberFunction)

## Static Public Member Functions

- static [SmartPointer](#)< [SimpleMemberCommand](#) > [New](#) ()

## Protected Member Functions

- [SimpleMemberCommand](#) ()
- [~SimpleMemberCommand](#) () override=default

## Protected Attributes

- [TMemberFunctionPointer m\\_MemberFunction](#)
- [T \\* m\\_This](#)

### 10.273.1 Detailed Description

```
template<typename T>
class gdcM::SimpleMemberCommand< T >
```

[Command](#) subclass that calls a pointer to a member function.

[SimpleMemberCommand](#) calls a pointer to a member function with no arguments.

### 10.273.2 Member Typedef Documentation

#### 10.273.2.1 Self

```
template<typename T >
typedef SimpleMemberCommand gdcM::SimpleMemberCommand< T >::Self
```

Standard class typedefs.

#### 10.273.2.2 TMemberFunctionPointer

```
template<typename T >
typedef void(T::* gdcM::SimpleMemberCommand< T >::TMemberFunctionPointer) ()
```

A method callback.

### 10.273.3 Constructor & Destructor Documentation

#### 10.273.3.1 SimpleMemberCommand() [1/2]

```
template<typename T >
gdcM::SimpleMemberCommand< T >::SimpleMemberCommand (
    const Self & ) [delete]
```

### 10.273.3.2 SimpleMemberCommand() [2/2]

```
template<typename T >
gdcM::SimpleMemberCommand< T >::SimpleMemberCommand ( ) [inline], [protected]
```

Referenced by gdcM::SimpleMemberCommand< T >::New().

### 10.273.3.3 ~SimpleMemberCommand()

```
template<typename T >
gdcM::SimpleMemberCommand< T >::~~SimpleMemberCommand ( ) [override], [protected], [default]
```

## 10.273.4 Member Function Documentation

### 10.273.4.1 Execute() [1/2]

```
template<typename T >
void gdcM::SimpleMemberCommand< T >::Execute (
    const Subject * caller,
    const Event & event ) [inline], [override], [virtual]
```

Abstract method that defines the action to be taken by the command. This variant is expected to be used when requests comes from a const [Object](#)

Implements [gdcM::Command](#).

References gdcM::SimpleMemberCommand< T >::m\_MemberFunction.

### 10.273.4.2 Execute() [2/2]

```
template<typename T >
void gdcM::SimpleMemberCommand< T >::Execute (
    Subject * ,
    const Event & ) [inline], [override], [virtual]
```

Invoke the callback function.

Implements [gdcM::Command](#).

References gdcM::SimpleMemberCommand< T >::m\_MemberFunction.

### 10.273.4.3 New()

```
template<typename T >
static SmartPointer<SimpleMemberCommand> gdcm::SimpleMemberCommand< T >::New ( ) [inline],
[static]
```

Run-time type information (and related methods). Method for creation through the object factory.

References [gdc](#)m::SimpleMemberCommand< T >::SimpleMemberCommand().

### 10.273.4.4 operator=()

```
template<typename T >
void gdcm::SimpleMemberCommand< T >::operator= (
    const Self & ) [delete]
```

### 10.273.4.5 SetCallbackFunction()

```
template<typename T >
void gdcm::SimpleMemberCommand< T >::SetCallbackFunction (
    T * object,
    TMemberFunctionPointer memberFunction ) [inline]
```

Specify the callback function.

References [gdc](#)m::SimpleMemberCommand< T >::m\_MemberFunction, and [gdc](#)m::SimpleMemberCommand< T >↔::m\_This.

## 10.273.5 Member Data Documentation

### 10.273.5.1 m\_MemberFunction

```
template<typename T >
TMemberFunctionPointer gdcm::SimpleMemberCommand< T >::m_MemberFunction [protected]
```

Referenced by [gdc](#)m::SimpleMemberCommand< T >::Execute(), and [gdc](#)m::SimpleMemberCommand< T >::Set↔CallbackFunction().



### 10.273.5.2 m\_This

```
template<typename T >
T* gdcm::SimpleMemberCommand< T >::m_This [protected]
```

Referenced by `gdcm::SimpleMemberCommand< T >::SetCallbackFunction()`.

The documentation for this class was generated from the following file:

- [gdcmCommand.h](#)

## 10.274 gdcm::SimpleSubjectWatcher Class Reference

[SimpleSubjectWatcher](#).

```
#include <gdcmSimpleSubjectWatcher.h>
```

### Public Member Functions

- [SimpleSubjectWatcher](#) (const [SimpleSubjectWatcher](#) &)=delete
- [SimpleSubjectWatcher](#) ([Subject](#) \*s, const char \*comment="")
- virtual [~SimpleSubjectWatcher](#) ()
- void [operator=](#) (const [SimpleSubjectWatcher](#) &)=delete

### Protected Member Functions

- virtual void [EndFilter](#) ()
- virtual void [ShowAbort](#) ()
- virtual void [ShowAnonymization](#) ([Subject](#) \*caller, const [Event](#) &evt)
- virtual void [ShowData](#) ([Subject](#) \*caller, const [Event](#) &evt)
- virtual void [ShowDataSet](#) ([Subject](#) \*caller, const [Event](#) &evt)
- virtual void [ShowFileName](#) ([Subject](#) \*caller, const [Event](#) &evt)
- virtual void [ShowIteration](#) ()
- virtual void [ShowProgress](#) ([Subject](#) \*caller, const [Event](#) &evt)
- virtual void [StartFilter](#) ()
- void [TestAbortOff](#) ()
- void [TestAbortOn](#) ()

### 10.274.1 Detailed Description

[SimpleSubjectWatcher](#).

This is a typical [Subject](#) Watcher class. It will observe all events.

#### Examples

[SimpleScanner.cxx](#).

## 10.274.2 Constructor & Destructor Documentation

### 10.274.2.1 SimpleSubjectWatcher() [1/2]

```
gdcM::SimpleSubjectWatcher::SimpleSubjectWatcher (
    Subject * s,
    const char * comment = "" )
```

### 10.274.2.2 ~SimpleSubjectWatcher()

```
virtual gdcM::SimpleSubjectWatcher::~~SimpleSubjectWatcher ( ) [virtual]
```

### 10.274.2.3 SimpleSubjectWatcher() [2/2]

```
gdcM::SimpleSubjectWatcher::SimpleSubjectWatcher (
    const SimpleSubjectWatcher & ) [delete]
```

## 10.274.3 Member Function Documentation

### 10.274.3.1 EndFilter()

```
virtual void gdcM::SimpleSubjectWatcher::EndFilter ( ) [protected], [virtual]
```

### 10.274.3.2 operator=()

```
void gdcM::SimpleSubjectWatcher::operator= (
    const SimpleSubjectWatcher & ) [delete]
```

### 10.274.3.3 ShowAbort()

```
virtual void gdcM::SimpleSubjectWatcher::ShowAbort ( ) [protected], [virtual]
```

### 10.274.3.4 ShowAnonymization()

```
virtual void gdcM::SimpleSubjectWatcher::ShowAnonymization (
    Subject * caller,
    const Event & evt ) [protected], [virtual]
```

### 10.274.3.5 ShowData()

```
virtual void gdcM::SimpleSubjectWatcher::ShowData (
    Subject * caller,
    const Event & evt ) [protected], [virtual]
```

### 10.274.3.6 ShowDataSet()

```
virtual void gdcM::SimpleSubjectWatcher::ShowDataSet (
    Subject * caller,
    const Event & evt ) [protected], [virtual]
```

### 10.274.3.7 ShowFileName()

```
virtual void gdcM::SimpleSubjectWatcher::ShowFileName (
    Subject * caller,
    const Event & evt ) [protected], [virtual]
```

#### Examples

[SimpleScanner.cxx](#).

**10.274.3.8 ShowIteration()**

```
virtual void gdcM::SimpleSubjectWatcher::ShowIteration ( ) [protected], [virtual]
```

**10.274.3.9 ShowProgress()**

```
virtual void gdcM::SimpleSubjectWatcher::ShowProgress (
    Subject * caller,
    const Event & evt ) [protected], [virtual]
```

**10.274.3.10 StartFilter()**

```
virtual void gdcM::SimpleSubjectWatcher::StartFilter ( ) [protected], [virtual]
```

**10.274.3.11 TestAbortOff()**

```
void gdcM::SimpleSubjectWatcher::TestAbortOff ( ) [protected]
```

**10.274.3.12 TestAbortOn()**

```
void gdcM::SimpleSubjectWatcher::TestAbortOn ( ) [protected]
```

The documentation for this class was generated from the following file:

- [gdcMSimpleSubjectWatcher.h](#)

## 10.275 gdcm::MrProtocol::Slice Struct Reference

```
#include <gdcmMrProtocol.h>
```

Collaboration diagram for gdcm::MrProtocol::Slice:

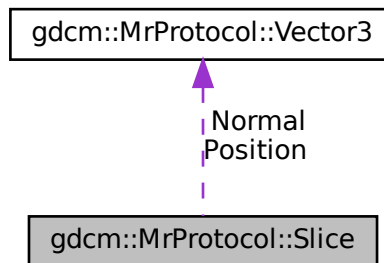

### Public Attributes

- [Vector3 Normal](#)
- [Vector3 Position](#)

### 10.275.1 Member Data Documentation

#### 10.275.1.1 Normal

[Vector3](#) gdcm::MrProtocol::Slice::Normal

#### 10.275.1.2 Position

[Vector3](#) gdcm::MrProtocol::Slice::Position

The documentation for this struct was generated from the following file:

- [gdcmMrProtocol.h](#)

## 10.276 gdcM::MrProtocol::SliceArray Struct Reference

```
#include <gdcMMrProtocol.h>
```

Collaboration diagram for gdcM::MrProtocol::SliceArray:

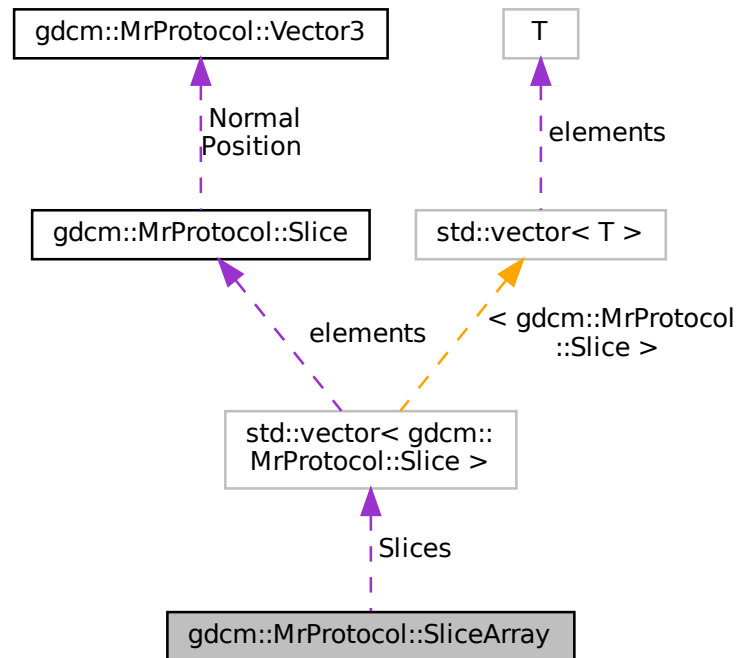

### Public Attributes

- `std::vector< Slice > Slices`

### 10.276.1 Member Data Documentation

#### 10.276.1.1 Slices

```
std::vector< Slice > gdcM::MrProtocol::SliceArray::Slices
```

The documentation for this struct was generated from the following file:

- [gdcMMrProtocol.h](#)

## 10.277 gdcM::SmartPointer< ObjectType > Class Template Reference

Class for Smart Pointer.

```
#include <gdcMSmartPointer.h>
```

Inheritance diagram for gdcM::SmartPointer< ObjectType >:

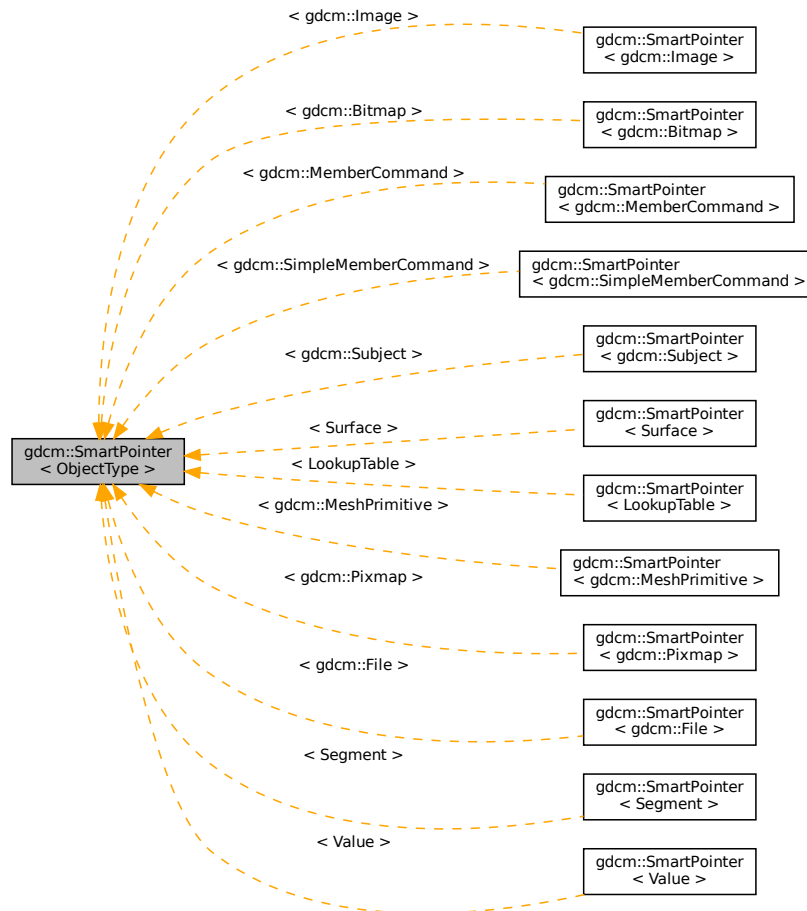

### Public Member Functions

- [SmartPointer](#) ()
- [SmartPointer](#) (const [SmartPointer](#)< ObjectType > &p)
- [SmartPointer](#) (ObjectType \*p)
- [SmartPointer](#) (ObjectType const &p)
- [~SmartPointer](#) ()
- ObjectType \* [GetPointer](#) () const

*Explicit function to retrieve the pointer.*

- `operator ObjectType * () const`  
*Return pointer to object.*
- `ObjectType & operator* () const`
- `ObjectType * operator-> () const`  
*Overload operator ->*
- `SmartPointer & operator= (ObjectType *r)`  
*Overload operator assignment.*
- `SmartPointer & operator= (ObjectType const &r)`
- `SmartPointer & operator= (SmartPointer const &r)`  
*Overload operator assignment.*

### 10.277.1 Detailed Description

```
template<class ObjectType>
class gdcm::SmartPointer< ObjectType >
```

Class for Smart Pointer.

Will only work for subclass of `gdcm::Object` See `tr1/shared_ptr` for a more general approach (not invasive) `#include <tr1/memory> { shared_ptr<Bla> b(new Bla); }`

#### Note

Class partly based on post by Bill Hubauer: <http://groups.google.com/group/comp.lang.c++.msg/173ddc38a827a930>

#### See also

<http://www.davethehat.com/articles/smartp.htm>

and `itk::SmartPointer`

#### Examples

[CStoreQtProgress.cxx](#), [ChangeSequenceUltrasound.cxx](#), [DumpGEMSMovieGroup.cxx](#), [DumpToshibaDTI.cxx](#), [DumpToshibaDTI2.cxx](#), [Extracting\\_All\\_Resolution.cxx](#), [Fake\\_Image\\_Using\\_Stream\\_Image\\_Writer.cxx](#), [FixBrokenJ2K.cxx](#), [GenAllVR.cxx](#), [GenFakeldentifyFile.cxx](#), [GenLongSeqs.cxx](#), [GenSeqs.cxx](#), [LargeVRDSExplicit.cxx](#), [ReadAndDumpDICOMDIR.cxx](#), [SimpleScanner.cxx](#), [gdcmrtonplan.cxx](#), and [gdcmrtpplan.cxx](#).

### 10.277.2 Constructor & Destructor Documentation



### 10.277.2.1 SmartPointer() [1/4]

```
template<class ObjectType >  
gdcmm::SmartPointer< ObjectType >::SmartPointer ( ) [inline]
```

### 10.277.2.2 SmartPointer() [2/4]

```
template<class ObjectType >  
gdcmm::SmartPointer< ObjectType >::SmartPointer (  
    const SmartPointer< ObjectType > & p ) [inline]
```

### 10.277.2.3 SmartPointer() [3/4]

```
template<class ObjectType >  
gdcmm::SmartPointer< ObjectType >::SmartPointer (  
    ObjectType * p ) [inline]
```

### 10.277.2.4 SmartPointer() [4/4]

```
template<class ObjectType >  
gdcmm::SmartPointer< ObjectType >::SmartPointer (  
    ObjectType const & p ) [inline]
```

### 10.277.2.5 ~SmartPointer()

```
template<class ObjectType >  
gdcmm::SmartPointer< ObjectType >::~SmartPointer ( ) [inline]
```

## 10.277.3 Member Function Documentation

### 10.277.3.1 GetPointer()

```
template<class ObjectType >
ObjectType* gdcm::SmartPointer< ObjectType >::GetPointer ( ) const [inline]
```

Explicit function to retrieve the pointer.

### 10.277.3.2 operator ObjectType \*()

```
template<class ObjectType >
gdcm::SmartPointer< ObjectType >::operator ObjectType * ( ) const [inline]
```

Return pointer to object.

### 10.277.3.3 operator\*()

```
template<class ObjectType >
ObjectType& gdcm::SmartPointer< ObjectType >::operator* ( ) const [inline]
```

### 10.277.3.4 operator->()

```
template<class ObjectType >
ObjectType* gdcm::SmartPointer< ObjectType >::operator-> ( ) const [inline]
```

Overload operator ->

### 10.277.3.5 operator=( ) [1/3]

```
template<class ObjectType >
SmartPointer& gdcm::SmartPointer< ObjectType >::operator= (
    ObjectType * r ) [inline]
```

Overload operator assignment.

**10.277.3.6 operator=()** [2/3]

```
template<class ObjectType >
SmartPointer& gdcm::SmartPointer< ObjectType >::operator= (
    ObjectType const & r ) [inline]
```

References `gdcm::SmartPointer< ObjectType >::operator=()`.

**10.277.3.7 operator=()** [3/3]

```
template<class ObjectType >
SmartPointer& gdcm::SmartPointer< ObjectType >::operator= (
    SmartPointer< ObjectType > const & r ) [inline]
```

Overload operator assignment.

Referenced by `gdcm::SmartPointer< ObjectType >::operator=()`.

The documentation for this class was generated from the following files:

- [gdcmObject.h](#)
- [gdcmSmartPointer.h](#)

## 10.278 gdcm::network::SOPClassExtendedNegotiationSub Class Reference

[SOPClassExtendedNegotiationSub](#).

```
#include <gdcmSOPClassExtendedNegotiationSub.h>
```

### Public Member Functions

- [SOPClassExtendedNegotiationSub](#) ()
- void [Print](#) (std::ostream &os) const
- std::istream & [Read](#) (std::istream &is)
- void [SetTuple](#) (const char \*uid, uint8\_t levelofsupport=3, uint8\_t levelofdigitalsig=0, uint8\_t elementcoercion=2)
- size\_t [Size](#) () const
- const std::ostream & [Write](#) (std::ostream &os) const

### 10.278.1 Detailed Description

[SOPClassExtendedNegotiationSub](#).

PS 3.7 [Table](#) D.3-11 SOP CLASS EXTENDED NEGOTIATION SUB-ITEM FIELDS (A-ASSOCIATE-RQ and A-↔ ASSOCIATE-AC)

## 10.278.2 Constructor & Destructor Documentation

### 10.278.2.1 SOPClassExtendedNegociationSub()

```
gdcM::network::SOPClassExtendedNegociationSub::SOPClassExtendedNegociationSub ( )
```

## 10.278.3 Member Function Documentation

### 10.278.3.1 Print()

```
void gdcM::network::SOPClassExtendedNegociationSub::Print (
    std::ostream & os ) const
```

### 10.278.3.2 Read()

```
std::istream& gdcM::network::SOPClassExtendedNegociationSub::Read (
    std::istream & is )
```

### 10.278.3.3 SetTuple()

```
void gdcM::network::SOPClassExtendedNegociationSub::SetTuple (
    const char * uid,
    uint8_t levelofsupport = 3,
    uint8_t levelofdigitalsig = 0,
    uint8_t elementcoercion = 2 )
```

### 10.278.3.4 Size()

```
size_t gdcM::network::SOPClassExtendedNegociationSub::Size ( ) const
```

### 10.278.3.5 Write()

```
const std::ostream& gdcm::network::SOPClassExtendedNegociationSub::Write (
    std::ostream & os ) const
```

The documentation for this class was generated from the following file:

- [gdcmSOPClassExtendedNegociationSub.h](#)

## 10.279 gdcm::SOPClassUIDToIOD Class Reference

Class convert a class SOP Class UID into [IOD](#).

```
#include <gdcmSOPClassUIDToIOD.h>
```

### Public Types

- typedef const char \* [const](#)(SOPClassUIDToIODType)[2]

### Static Public Member Functions

- static [const](#) char \* [GetIOD](#) (UIDs [const](#) &uid)
- static [const](#) char \* [GetIODFromSOPClassUID](#) ([const](#) char \*sopclassuid)
- static unsigned int [GetNumberOfSOPClassToIOD](#) ()  
*Return the number of SOP Class UID listed internally.*
- static [const](#) char \* [GetSOPClassUIDFromIOD](#) ([const](#) char \*iod)
- static SOPClassUIDToIODType & [GetSOPClassUIDToIOD](#) (unsigned int i)
- static SOPClassUIDToIODType \* [GetSOPClassUIDToIODs](#) ()

### 10.279.1 Detailed Description

Class convert a class SOP Class UID into [IOD](#).

Reference PS 3.4 [Table B.5-1](#) STANDARD SOP CLASSES

### 10.279.2 Member Typedef Documentation

#### 10.279.2.1 const

```
typedef const char* gdcm::SOPClassUIDToIOD::const (SOPClassUIDToIODType) [2]
```

## 10.279.3 Member Function Documentation

### 10.279.3.1 GetIOD()

```
static const char* gdcM::SOPClassUIDToIOD::GetIOD (
    UIDs const & uid ) [static]
```

Return the associated [IOD](#) based on a SOP Class UID uid (there is a one-to-one mapping from SOP Class UID to matching [IOD](#))

#### Examples

[GenerateStandardSOPClasses.cxx](#).

### 10.279.3.2 GetIODFromSOPClassUID()

```
static const char* gdcM::SOPClassUIDToIOD::GetIODFromSOPClassUID (
    const char * sopclassuid ) [static]
```

### 10.279.3.3 GetNumberOfSOPClassToIOD()

```
static unsigned int gdcM::SOPClassUIDToIOD::GetNumberOfSOPClassToIOD ( ) [static]
```

Return the number of SOP Class UID listed internally.

### 10.279.3.4 GetSOPClassUIDFromIOD()

```
static const char* gdcM::SOPClassUIDToIOD::GetSOPClassUIDFromIOD (
    const char * iod ) [static]
```

### 10.279.3.5 GetSOPClassUIDToIOD()

```
static SOPClassUIDToIODType& gdcM::SOPClassUIDToIOD::GetSOPClassUIDToIOD (
    unsigned int i ) [static]
```

10.279.3.6 GetSOPClassUIDToIODs()

```
static SOPClassUIDToIODType* gdcm::SOPClassUIDToIOD::GetSOPClassUIDToIODs ( ) [static]
```

The documentation for this class was generated from the following file:

- [gdcmSOPClassUIDToIOD.h](#)

10.280 gdcm::Sorter Class Reference

[Sorter](#).

```
#include <gdcmSorter.h>
```

Inheritance diagram for gdcm::Sorter:

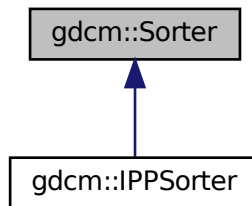

Collaboration diagram for gdcm::Sorter:

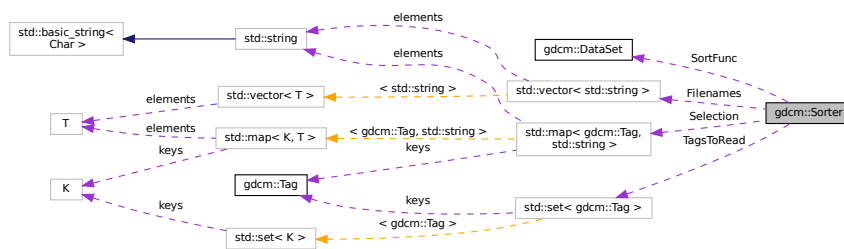

Public Types

- typedef bool(\* [SortFunction](#)) ([DataSet](#) const &, [DataSet](#) const &)  
*Set the sort function which compares one dataset to the other.*

## Public Member Functions

- [Sorter](#) ()
- virtual [~Sorter](#) ()
- bool [AddSelect](#) ([Tag](#) const &tag, const char \*value)  
*UNSUPPORTED FOR NOW.*
- const std::vector< std::string > & [GetFileNames](#) () const
- void [Print](#) (std::ostream &os) const  
*Print.*
- void [SetSortFunction](#) ([SortFunction](#) f)
- void [SetTagsToRead](#) (std::set< [Tag](#) > const &tags)
- virtual bool [Sort](#) (std::vector< std::string > const &filenames)  
*Typically the output of [Directory::GetFileNames\(\)](#)*
- virtual bool [StableSort](#) (std::vector< std::string > const &filenames)

## Protected Types

- typedef std::map< [Tag](#), std::string > [SelectionMap](#)

## Protected Attributes

- std::vector< std::string > [FileNames](#)
- std::map< [Tag](#), std::string > [Selection](#)
- [SortFunction](#) [SortFunc](#)
- std::set< [Tag](#) > [TagsToRead](#)

## Friends

- std::ostream & [operator<<](#) (std::ostream &\_os, const [Sorter](#) &s)

### 10.280.1 Detailed Description

[Sorter](#).

General class to do sorting using a custom function You simply need to provide a function of type: [Sorter::SortFunction](#)

Warning

implementation details. For now there is no cache mechanism. Which means that every time you call [Sort](#), all files specified as input parameter are *read*

See also

[Scanner](#)

Examples

[SortImage.cxx](#), and [VolumeSorter.cxx](#).



## 10.280.2 Member Typedef Documentation

### 10.280.2.1 SelectionMap

```
typedef std::map<Tag, std::string> gdcM::Sorter::SelectionMap [protected]
```

### 10.280.2.2 SortFunction

```
typedef bool(* gdcM::Sorter::SortFunction) (DataSet const &, DataSet const &)
```

Set the sort function which compares one dataset to the other.

## 10.280.3 Constructor & Destructor Documentation

### 10.280.3.1 Sorter()

```
gdcM::Sorter::Sorter ( )
```

### 10.280.3.2 ~Sorter()

```
virtual gdcM::Sorter::~~Sorter ( ) [virtual]
```

## 10.280.4 Member Function Documentation

### 10.280.4.1 AddSelect()

```
bool gdcM::Sorter::AddSelect (
    Tag const & tag,
    const char * value )
```

UNSUPPORTED FOR NOW.

#### 10.280.4.2 GetFileNames()

```
const std::vector<std::string>& gdcM::Sorter::GetFileNames ( ) const [inline]
```

Return the list of filenames as sorted by the specific algorithm used. Empty by default (before [Sort\(\)](#) is called)

##### Examples

[Compute3DSpacing.cxx](#), [SortImage.cxx](#), [VolumeSorter.cxx](#), [gdcMOrthoplanes.cxx](#), and [reslicesphere.cxx](#).

#### 10.280.4.3 Print()

```
void gdcM::Sorter::Print (
    std::ostream & os ) const
```

Print.

##### Examples

[SortImage.cxx](#), [VolumeSorter.cxx](#), and [gdcMOrthoplanes.cxx](#).

#### 10.280.4.4 SetSortFunction()

```
void gdcM::Sorter::SetSortFunction (
    SortFunction f )
```

##### Examples

[SortImage.cxx](#), and [VolumeSorter.cxx](#).

#### 10.280.4.5 SetTagsToRead()

```
void gdcM::Sorter::SetTagsToRead (
    std::set< Tag > const & tags )
```

Specify a set of tags to be read in during the sort procedure. By default this set is empty, in which case the entire image, including pixel data, is read in.

### 10.280.4.6 Sort()

```
virtual bool gdcM::Sorter::Sort (
    std::vector< std::string > const & filenames ) [virtual]
```

Typically the output of [Directory::GetFilenames\(\)](#)

Reimplemented in [gdcM::IPPSorter](#).

#### Examples

[SortImage.cxx](#).

### 10.280.4.7 StableSort()

```
virtual bool gdcM::Sorter::StableSort (
    std::vector< std::string > const & filenames ) [virtual]
```

#### Examples

[SortImage.cxx](#), and [VolumeSorter.cxx](#).

## 10.280.5 Friends And Related Function Documentation

### 10.280.5.1 operator<<

```
std::ostream& operator<< (
    std::ostream & _os,
    const Sorter & s ) [friend]
```

## 10.280.6 Member Data Documentation

### 10.280.6.1 Filenames

```
std::vector<std::string> gdcM::Sorter::Filenames [protected]
```

### 10.280.6.2 Selection

`std::map<Tag, std::string> gdcM::Sorter::Selection` [protected]

### 10.280.6.3 SortFunc

`SortFunction` `gdcM::Sorter::SortFunc` [protected]

### 10.280.6.4 TagsToRead

`std::set<Tag> gdcM::Sorter::TagsToRead` [protected]

The documentation for this class was generated from the following file:

- [gdcMSorter.h](#)

## 10.281 gdcM::Spacing Class Reference

Class for [Spacing](#).

```
#include <gdcMSpacing.h>
```

### Public Types

- enum [SpacingType](#) {  
    [DETECTOR](#) = 0 ,  
    [MAGNIFIED](#) ,  
    [CALIBRATED](#) ,  
    [UNKNOWN](#) }

### Public Member Functions

- [Spacing](#) ()
- [~Spacing](#) ()

### Static Public Member Functions

- static [Attribute](#)< 0x28, 0x34 > [ComputePixelAspectRatioFromPixelSpacing](#) (const [Attribute](#)< 0x28, 0x30 > &pixelspacing)

## 10.281.1 Detailed Description

Class for [Spacing](#).

It all began with a mail to WG6:

**Subject:** Imager Pixel [Spacing](#) vs Pixel [Spacing](#) **Body:** [Apologies for the duplicate post, namely to David Clunie & OFFIS team]

I have been trying to understand CP-586 in the following two cases:

On the one hand:

- DISCIMG/IMAGES/CRIMAGE taken from <http://dclunie.com/images/pixelspacingtestimages.↵.zip>

And on the other hand:

- [http://gdcm.sourceforge.net/thingies/cr\\_pixelspacing.dcm](http://gdcm.sourceforge.net/thingies/cr_pixelspacing.dcm)

If I understand correctly the CP, one is required to use Pixel [Spacing](#) for measurement ('true size' print) instead of Imager Pixel [Spacing](#), since the two attributes are present and Pixel [Spacing](#) is different from Imager Pixel [Spacing](#).

If this is correct, then the test data DISCIMG/IMAGES/CRIMAGE is incorrect. If this is incorrect (ie. I need to use Imager Pixel [Spacing](#)), then the display of cr\_pixelspacing.dcm for measurement will be incorrect.

Could someone please let me know what am I missing here? I could not find any information in any header that would allow me to differentiate those.

Thank you for your time,

Ref: <http://lists.nema.org/scripts/lyris.pl?sub=488573&id=400720477>

See PS 3.3-2008, [Table C.7-11b](#) IMAGE PIXEL MACRO ATTRIBUTES

Ratio of the vertical size and horizontal size of the pixels in the image specified by a pair of integer values where the first value is the vertical pixel size, and the second value is the horizontal pixel size. Required if the aspect ratio values do not have a ratio of 1:1 and the physical pixel spacing is not specified by Pixel [Spacing](#) (0028,0030), or Imager Pixel [Spacing](#) (0018,1164) or Nominal Scanned Pixel [Spacing](#) (0018,2010), either for the entire [Image](#) or per-frame in a Functional Group [Macro](#). See C.7.6.3.1.7.

PS 3.3-2008 10.7.1.3 Pixel [Spacing Value](#) Order and Valid Values All pixel spacing related attributes shall have non-zero values, except when there is only a single row or column or pixel of data present, in which case the corresponding value may be zero.

Ref: [http://gdcm.sourceforge.net/wiki/index.php/Imager\\_Pixel\\_Spacing](http://gdcm.sourceforge.net/wiki/index.php/Imager_Pixel_Spacing)

## 10.281.2 Member Enumeration Documentation

### 10.281.2.1 SpacingType

```
enum gdcm::Spacing::SpacingType
```

## Enumerator

DETECTOR	
MAGNIFIED	
CALIBRATED	
UNKNOWN	

### 10.281.3 Constructor & Destructor Documentation

#### 10.281.3.1 Spacing()

```
gdcM::Spacing::Spacing ( )
```

#### 10.281.3.2 ~Spacing()

```
gdcM::Spacing::~Spacing ( )
```

### 10.281.4 Member Function Documentation

#### 10.281.4.1 ComputePixelAspectRatioFromPixelSpacing()

```
static Attribute<0x28,0x34> gdcM::Spacing::ComputePixelAspectRatioFromPixelSpacing (
    const Attribute< 0x28, 0x30 > & pixelSpacing ) [static]
```

The documentation for this class was generated from the following file:

- [gdcMSpacing.h](#)

## 10.282 gdcM::Spectroscopy Class Reference

[Spectroscopy](#) class.

```
#include <gdcMSpectroscopy.h>
```

## Public Member Functions

- [Spectroscopy](#) ()=default

### 10.282.1 Detailed Description

[Spectroscopy](#) class.

### 10.282.2 Constructor & Destructor Documentation

#### 10.282.2.1 Spectroscopy()

```
gdcM::Spectroscopy::Spectroscopy ( ) [default]
```

The documentation for this class was generated from the following file:

- [gdcMSpectroscopy.h](#)

## 10.283 gdcM::SplitMosaicFilter Class Reference

[SplitMosaicFilter](#) class.

```
#include <gdcMSplitMosaicFilter.h>
```

## Public Member Functions

- [SplitMosaicFilter](#) ()
- [~SplitMosaicFilter](#) ()
- bool [ComputeMOSAICDimensions](#) (unsigned int dims[3])
- bool [ComputeMOSAICSliceNormal](#) (double dims[3], bool &inverted)
  - Extract the value for SliceNormalVector (CSA header)*
- bool [ComputeMOSAICSlicePosition](#) (double pos[3], bool inverted)
  - Extract the value for ImagePositionPatient (requires inverted flag)*
- [File](#) & [GetFile](#) ()
- const [File](#) & [GetFile](#) () const
- [Image](#) & [GetImage](#) ()
- const [Image](#) & [GetImage](#) () const
- void [SetFile](#) (const [File](#) &f)
- void [SetImage](#) (const [Image](#) &image)
- bool [Split](#) ()
  - Split the SIEMENS MOSAIC image.*

## Static Public Member Functions

- static bool [GetAcquisitionSize](#) (unsigned int size[2], [DataSet](#) const &ds)  
*Get the Acquisition Matrix (non zero value):*
- static unsigned int [GetNumberOfImagesInMosaic](#) ([File](#) const &file)  
*Return the value for NumberOfImagesInMosaic, or compute it from Acquisition Size.*

### 10.283.1 Detailed Description

[SplitMosaicFilter](#) class.

Class to reshuffle bytes for a SIEMENS Mosaic image Siemens CSA [Image](#) Header CSA:= Common Siemens Architecture, sometimes also known as Common syngo Architecture

#### Warning

when private attributes are not found, the acquisition matrix is used to compute the NumberOfImagesInMosaic. This means trailing black slices will be considered in the volume (instead of discarded). CSA 0029,1010 is needed for correct NumberOfImagesInMosaic CSA 0029,1020 is needed to compute the correct origin without above info default are taken (may not be accurate).

### 10.283.2 Constructor & Destructor Documentation

#### 10.283.2.1 [SplitMosaicFilter](#)()

```
gdcm::SplitMosaicFilter::SplitMosaicFilter ( )
```

#### 10.283.2.2 [~SplitMosaicFilter](#)()

```
gdcm::SplitMosaicFilter::~SplitMosaicFilter ( )
```

### 10.283.3 Member Function Documentation

#### 10.283.3.1 [ComputeMOSAICDimensions](#)()

```
bool gdcm::SplitMosaicFilter::ComputeMOSAICDimensions (
    unsigned int dims[3] )
```

Compute the new dimensions according to private information stored in the MOSAIC header.



### 10.283.3.2 ComputeMOSAICSliceNormal()

```
bool gdcm::SplitMosaicFilter::ComputeMOSAICSliceNormal (
    double dims[3],
    bool & inverted )
```

Extract the value for SliceNormalVector (CSA header)

### 10.283.3.3 ComputeMOSAICSlicePosition()

```
bool gdcm::SplitMosaicFilter::ComputeMOSAICSlicePosition (
    double pos[3],
    bool inverted )
```

Extract the value for ImagePositionPatient (requires inverted flag)

### 10.283.3.4 GetAcquisitionSize()

```
static bool gdcm::SplitMosaicFilter::GetAcquisitionSize (
    unsigned int size[2],
    DataSet const & ds ) [static]
```

Get the Acquisition Matrix (non zero value):

### 10.283.3.5 GetFile() [1/2]

```
File& gdcm::SplitMosaicFilter::GetFile ( ) [inline]
```

### 10.283.3.6 GetFile() [2/2]

```
const File& gdcm::SplitMosaicFilter::GetFile ( ) const [inline]
```

### 10.283.3.7 GetImage() [1/2]

```
Image& gdcm::SplitMosaicFilter::GetImage ( ) [inline]
```

### 10.283.3.8 GetImage() [2/2]

```
const Image& gdcM::SplitMosaicFilter::GetImage ( ) const [inline]
```

### 10.283.3.9 GetNumberOfImagesInMosaic()

```
static unsigned int gdcM::SplitMosaicFilter::GetNumberOfImagesInMosaic (
    File const & file ) [static]
```

Return the value for NumberOfImagesInMosaic, or compute it from Acquisition Size.

### 10.283.3.10 SetFile()

```
void gdcM::SplitMosaicFilter::SetFile (
    const File & f ) [inline]
```

### 10.283.3.11 SetImage()

```
void gdcM::SplitMosaicFilter::SetImage (
    const Image & image )
```

### 10.283.3.12 Split()

```
bool gdcM::SplitMosaicFilter::Split ( )
```

Split the SIEMENS MOSAIC image.

The documentation for this class was generated from the following file:

- [gdcMSplitMosaicFilter.h](#)

## 10.284 gdcM::StartEvent Class Reference

```
#include <gdcMEvent.h>
```

Inheritance diagram for gdcM::StartEvent:

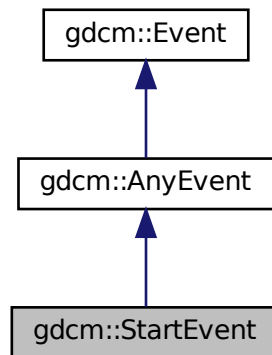

Collaboration diagram for gdcM::StartEvent:

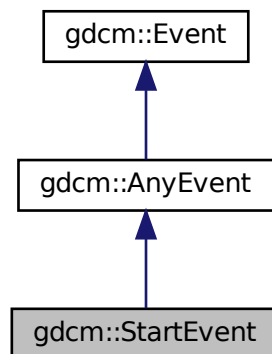

### Additional Inherited Members

The documentation for this class was generated from the following file:

- [gdcMEvent.h](#)

## 10.285 `gdcm::static_assert_test< x >` Struct Template Reference

```
#include <gdcmStaticAssert.h>
```

The documentation for this struct was generated from the following file:

- [gdcmStaticAssert.h](#)

## 10.286 `gdcm::STATIC_ASSERTION_FAILURE< x >` Struct Template Reference

The documentation for this struct was generated from the following file:

- [gdcmStaticAssert.h](#)

## 10.287 `gdcm::STATIC_ASSERTION_FAILURE< true >` Struct Reference

```
#include <gdcmStaticAssert.h>
```

### Public Types

- enum { `value` = 1 }

### 10.287.1 Member Enumeration Documentation

#### 10.287.1.1 anonymous enum

```
anonymous enum
```

Enumerator

value	
-------	--

The documentation for this struct was generated from the following file:

- [gdcmStaticAssert.h](#)

## 10.288 gdcm::StreamImageReader Class Reference

[StreamImageReader](#).

```
#include <gdcmStreamImageReader.h>
```

### Public Member Functions

- [StreamImageReader](#) ()
- virtual [~StreamImageReader](#) ()
- bool [CanReadImage](#) () const
- void [DefinePixelExtent](#) (uint16\_t inXMin, uint16\_t inXMax, uint16\_t inYMin, uint16\_t inYMax, uint16\_t inZMin=0, uint16\_t inZMax=1)
- uint32\_t [DefineProperBufferLength](#) () const
- std::vector< unsigned int > [GetDimensionsValueForResolution](#) (unsigned int)
- [File](#) const & [GetFile](#) () const
- bool [Read](#) (char \*inReadBuffer, const std::size\_t &inBufferLength)
- virtual bool [ReadImageInformation](#) ()
- void [SetFileName](#) (const char \*inFileName)
- void [SetStream](#) (std::istream &inStream)

### 10.288.1 Detailed Description

[StreamImageReader](#).

#### Note

its role is to convert the DICOM [DataSet](#) into a [Image](#) representation via an ITK streaming (ie, multithreaded) interface [Image](#) is different from [Pixmap](#) has it has a position and a direction in Space. Currently, this class is thread safe in that it can read a single extent in a single thread. Multiple versions can be used for multiple extents/threads.

#### See also

[Image](#)

#### Examples

[StreamImageReaderTest.cxx](#).

### 10.288.2 Constructor & Destructor Documentation

### 10.288.2.1 StreamImageReader()

```
gdcM::StreamImageReader::StreamImageReader ( )
```

### 10.288.2.2 ~StreamImageReader()

```
virtual gdcM::StreamImageReader::~~StreamImageReader ( ) [virtual]
```

## 10.288.3 Member Function Documentation

### 10.288.3.1 CanReadImage()

```
bool gdcM::StreamImageReader::CanReadImage ( ) const
```

Only RAW images are currently readable by the stream reader. As more streaming codecs are added, then this function will be updated to reflect those changes. Calling this function prior to reading will ensure that only streamable files are streamed. Make sure to call ReadImageInformation prior to calling this function.

#### Examples

[StreamImageReaderTest.cxx](#).

### 10.288.3.2 DefinePixelExtent()

```
void gdcM::StreamImageReader::DefinePixelExtent (
    uint16_t inXMin,
    uint16_t inXMax,
    uint16_t inYMin,
    uint16_t inYMax,
    uint16_t inZMin = 0,
    uint16_t inZMax = 1 )
```

Defines an image extent for the Read function. DICOM states that an image can have no more than  $2^{16}$  pixels per edge (as of 2009) In this case, the pixel extents ignore the direction cosines entirely, and assumes that the origin of the image is at location 0,0 (regardless of the definition in space per the tags). So, if the first 100 pixels of the first row are to be read in, this function should be called with DefinePixelExtent(0, 100, 0, 1), regardless of pixel size or orientation.

#### Examples

[StreamImageReaderTest.cxx](#).

### 10.288.3.3 DefineProperBufferLength()

```
uint32_t gdcm::StreamImageReader::DefineProperBufferLength ( ) const
```

Paying attention to the pixel format and so forth, define the proper buffer length for the user. The return amount is in bytes. Call this function to determine the size of the char\* buffer that will need to be passed in to ReadImageSubregion(). If the return is 0, then that means that the pixel extent was not defined prior

#### Examples

[StreamImageReaderTest.cxx](#).

### 10.288.3.4 GetDimensionsValueForResolution()

```
std::vector<unsigned int> gdcm::StreamImageReader::GetDimensionsValueForResolution (
    unsigned int )
```

### 10.288.3.5 GetFile()

```
File const& gdcm::StreamImageReader::GetFile ( ) const
```

Returns the dataset read by ReadImageInformation Couple this with the [ImageHelper](#) to get statistics about the image, like pixel extent, to be able to initialize buffers for reading

#### Examples

[StreamImageReaderTest.cxx](#).

### 10.288.3.6 Read()

```
bool gdcm::StreamImageReader::Read (
    char * inReadBuffer,
    const std::size_t & inBufferLength )
```

Read the DICOM image. There are three reasons for failure:

1. The extent is not set
2. the conversion from char\* to std::ostream (internally) fails
3. the given buffer isn't large enough to accommodate the desired pixel extent. This method has been implemented to look similar to the `metainageio` in `itk` MUST have an extent defined, or else Read will return false. If no particular extent is required, use [ImageReader](#) instead.

#### Examples

[StreamImageReaderTest.cxx](#).

### 10.288.3.7 ReadImageInformation()

```
virtual bool gdcM::StreamImageReader::ReadImageInformation ( ) [virtual]
```

Set the spacing and dimension information for the set filename. returns false if the file is not initialized or not an image, with the pixel (7fe0,0010) tag.

#### Examples

[StreamImageReaderTest.cxx](#).

### 10.288.3.8 SetFileName()

```
void gdcM::StreamImageReader::SetFileName (
    const char * inFileName )
```

One of either SetFileName or SetStream must be called prior to any other functions. These initialize an internal [Reader](#) class to be able to get non-pixel image information.

#### Examples

[ExtractOneFrame.cs](#), and [StreamImageReaderTest.cxx](#).

### 10.288.3.9 SetStream()

```
void gdcM::StreamImageReader::SetStream (
    std::istream & inStream )
```

The documentation for this class was generated from the following file:

- [gdcMStreamImageReader.h](#)



## 10.289 gdcm::StreamImageWriter Class Reference

[StreamImageReader](#).

```
#include <gdcmStreamImageWriter.h>
```

Collaboration diagram for gdcm::StreamImageWriter:

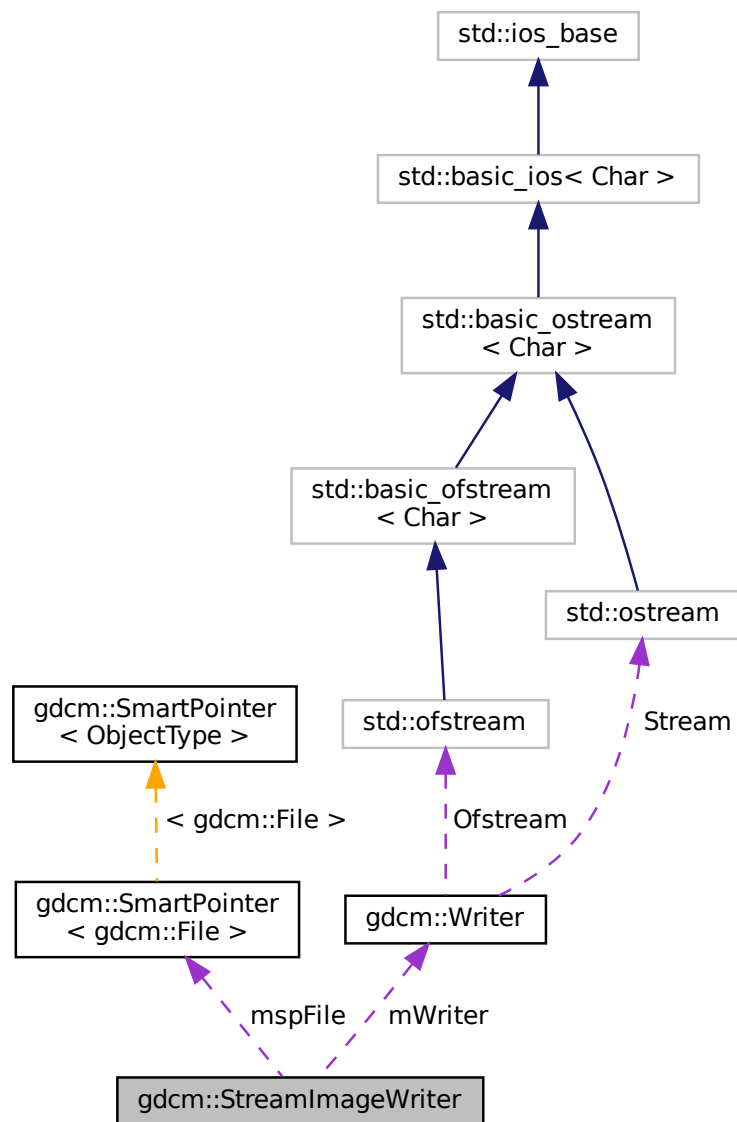

## Public Member Functions

- [StreamImageWriter](#) ()
- virtual [~StreamImageWriter](#) ()
- bool [CanWriteFile](#) () const
- void [DefinePixelExtent](#) (uint16\_t inXMin, uint16\_t inXMax, uint16\_t inYMin, uint16\_t inYMax, uint16\_t inZMin=0, uint16\_t inZMax=1)
- uint32\_t [DefineProperBufferLength](#) ()
- void [SetFile](#) (const [File](#) &inFile)
- void [SetFileName](#) (const char \*inFileName)
- void [SetStream](#) (std::ostream &inStream)
- bool [Write](#) (void \*inWriteBuffer, const std::size\_t &inBufferLength)
- virtual bool [WriteImageInformation](#) ()

## Protected Member Functions

- virtual bool [WriteImageSubregionRAW](#) (char \*inWriteBuffer, const std::size\_t &inBufferLength)
- int [WriteRawHeader](#) ([RAWCodec](#) \*inCodec, std::ostream \*inStream)

## Protected Attributes

- int [mElementOffsets](#)
- int [mElementOffsets1](#)
- [SmartPointer](#)< [File](#) > [mspFile](#)
- [Writer](#) [mWriter](#)
- uint16\_t [mXMax](#)
- uint16\_t [mXMin](#)
- uint16\_t [mYMax](#)
- uint16\_t [mYMin](#)
- uint16\_t [mZMax](#)
- uint16\_t [mZMin](#)

### 10.289.1 Detailed Description

[StreamImageReader](#).

#### Note

its role is to convert the DICOM [DataSet](#) into a [Image](#) representation via an ITK streaming (ie, multithreaded) interface [Image](#) is different from [Pixmap](#) has it has a position and a direction in Space. Currently, this class is threadsafe in that it can read a single extent in a single thread. Multiple versions can be used for multiple extents/threads.

#### See also

[Image](#)

#### Examples

[Extracting\\_All\\_Resolution.cxx](#), [Fake\\_Image\\_Using\\_Stream\\_Image\\_Writer.cxx](#), and [StreamImageReaderTest.cxx](#).

## 10.289.2 Constructor & Destructor Documentation

### 10.289.2.1 StreamImageWriter()

```
gdcm::StreamImageWriter::StreamImageWriter ( )
```

### 10.289.2.2 ~StreamImageWriter()

```
virtual gdcm::StreamImageWriter::~~StreamImageWriter ( ) [virtual]
```

## 10.289.3 Member Function Documentation

### 10.289.3.1 CanWriteFile()

```
bool gdcm::StreamImageWriter::CanWriteFile ( ) const
```

This function determines if a file can even be written using the streaming writer unlike the reader, can be called before WriteImageInformation, but must be called after SetFile.

#### Examples

[Extracting\\_All\\_Resolution.cxx](#), and [Fake\\_Image\\_Using\\_Stream\\_Image\\_Writer.cxx](#).

### 10.289.3.2 DefinePixelExtent()

```
void gdcm::StreamImageWriter::DefinePixelExtent (
    uint16_t inXMin,
    uint16_t inXMax,
    uint16_t inYMin,
    uint16_t inYMax,
    uint16_t inZMin = 0,
    uint16_t inZMax = 1 )
```

Defines an image extent for the Read function. DICOM states that an image can have no more than  $2^{16}$  pixels per edge (as of 2009) In this case, the pixel extents ignore the direction cosines entirely, and assumes that the origin of the image is at location 0,0 (regardless of the definition in space per the tags). So, if the first 100 pixels of the first row are to be read in, this function should be called with DefinePixelExtent(0, 100, 0, 1), regardless of pixel size or orientation. 15 nov 2010: added z dimension, defaults to being 1 plane large

#### Examples

[Extracting\\_All\\_Resolution.cxx](#), [Fake\\_Image\\_Using\\_Stream\\_Image\\_Writer.cxx](#), and [StreamImageReaderTest.cxx](#).

### 10.289.3.3 DefineProperBufferLength()

```
uint32_t gdcM::StreamImageWriter::DefineProperBufferLength ( )
```

Paying attention to the pixel format and so forth, define the proper buffer length for the user. The return amount is in bytes. If the return is 0, then that means that the pixel extent was not defined prior this return is for RAW inputs which are then encoded by the writer, but are used to ensure that the writer gets the proper buffer size

#### Examples

[Extracting\\_All\\_Resolution.cxx](#), [Fake\\_Image\\_Using\\_Stream\\_Image\\_Writer.cxx](#), and [StreamImageReaderTest.cxx](#).

### 10.289.3.4 SetFile()

```
void gdcM::StreamImageWriter::SetFile (
    const File & inFile )
```

Set the image information to be written to disk that is everything but the pixel information: (7fe0,0010) PixelData

#### Examples

[Extracting\\_All\\_Resolution.cxx](#), [Fake\\_Image\\_Using\\_Stream\\_Image\\_Writer.cxx](#), and [StreamImageReaderTest.cxx](#).

### 10.289.3.5 SetFileName()

```
void gdcM::StreamImageWriter::SetFileName (
    const char * inFileName )
```

One of either SetFileName or SetStream must be called prior to any other functions. These initialize an internal [Reader](#) class to be able to get non-pixel image information.

### 10.289.3.6 SetStream()

```
void gdcM::StreamImageWriter::SetStream (
    std::ostream & inStream )
```

#### Examples

[Extracting\\_All\\_Resolution.cxx](#), [Fake\\_Image\\_Using\\_Stream\\_Image\\_Writer.cxx](#), and [StreamImageReaderTest.cxx](#).

### 10.289.3.7 Write()

```
bool gdcm::StreamImageWriter::Write (
    void * inWriteBuffer,
    const std::size_t & inBufferLength )
```

Read the DICOM image. There are three reasons for failure:

1. The extent is not set
2. the conversion from void\* to std::ostream (internally) fails
3. the given buffer isn't large enough to accommodate the desired pixel extent. This method has been implemented to look similar to the `metainageio` in `itk` MUST have an extent defined, or else `Read` will return false. If no particular extent is required, use [ImageReader](#) instead.

#### Examples

[Extracting\\_All\\_Resolution.cxx](#), [Fake\\_Image\\_Using\\_Stream\\_Image\\_Writer.cxx](#), and [StreamImageReaderTest.cxx](#).

### 10.289.3.8 WriteImageInformation()

```
virtual bool gdcm::StreamImageWriter::WriteImageInformation ( ) [virtual]
```

Write the header information to disk, and a bunch of zeros for the actual pixel information. Of course, if we're doing a non-compressed format, that works but if it's compressed, we have to force the ordering of chunks that are written.

#### Examples

[Extracting\\_All\\_Resolution.cxx](#), [Fake\\_Image\\_Using\\_Stream\\_Image\\_Writer.cxx](#), and [StreamImageReaderTest.cxx](#).

### 10.289.3.9 WriteImageSubregionRAW()

```
virtual bool gdcm::StreamImageWriter::WriteImageSubregionRAW (
    char * inWriteBuffer,
    const std::size_t & inBufferLength ) [protected], [virtual]
```

Using the min, max, etc set by `DefinePixelExtent`, this will fill the given buffer. Make sure to call `DefinePixelExtent` and to initialize the buffer with the amount given by `DefineProperBufferLength` prior to calling this. reads by the RAW codec; other codecs are added once implemented

### 10.289.3.10 WriteRawHeader()

```
int gdcM::StreamImageWriter::WriteRawHeader (
    RAWCodec * inCodec,
    std::ostream * inStream ) [protected]
```

when writing a raw file, we know the full extent, and can just write the first 12 bytes out (the tag, the [VR](#), and the size) when we do compressed files, we'll do it in chunks, as described in 2009-3, part 5, Annex A, section 4. Pass the raw codec so that in the rare case of a bigendian explicit raw, the first 12 bytes written out should still be kosher. returns -1 if there's any failure, or the complete offset (12 bytes) if it works. Those 12 bytes are then added to the position in order to determine where to write.

## 10.289.4 Member Data Documentation

### 10.289.4.1 mElementOffsets

```
int gdcM::StreamImageWriter::mElementOffsets [protected]
```

The result of WriteRawHeader (or another header, when that's implemented) This result is saved so that the first N bytes aren't constantly being rewritten for each chunk that's passed in. For compressed data, the offset table will require rewrites of data.

### 10.289.4.2 mElementOffsets1

```
int gdcM::StreamImageWriter::mElementOffsets1 [protected]
```

### 10.289.4.3 mspFile

```
SmartPointer<File> gdcM::StreamImageWriter::mspFile [protected]
```

### 10.289.4.4 mWriter

```
Writer gdcM::StreamImageWriter::mWriter [protected]
```

#### 10.289.4.5 mXMax

uint16\_t gdcm::StreamImageWriter::mXMax [protected]

#### 10.289.4.6 mXMin

uint16\_t gdcm::StreamImageWriter::mXMin [protected]

#### 10.289.4.7 mYMax

uint16\_t gdcm::StreamImageWriter::mYMax [protected]

#### 10.289.4.8 mYMin

uint16\_t gdcm::StreamImageWriter::mYMin [protected]

#### 10.289.4.9 mZMax

uint16\_t gdcm::StreamImageWriter::mZMax [protected]

#### 10.289.4.10 mZMin

uint16\_t gdcm::StreamImageWriter::mZMin [protected]

The documentation for this class was generated from the following file:

- [gdcmStreamImageWriter.h](#)

## 10.290 gdcM::StrictScanner Class Reference

[StrictScanner](#).

```
#include <gdcMStrictScanner.h>
```

Inheritance diagram for gdcM::StrictScanner:

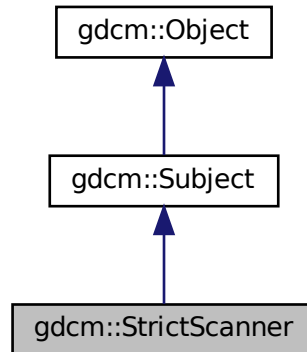

Collaboration diagram for gdcM::StrictScanner:

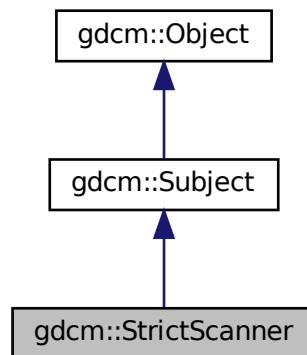

### Classes

- struct [ltstr](#)



## Public Types

- typedef MappingType::const\_iterator [ConstIterator](#)
- typedef std::map< const char \*, [TagToValue](#), [Itstr](#) > [MappingType](#)
- typedef std::map< [Tag](#), const char \* > [TagToValue](#)
- typedef TagToValue::value\_type [TagToValueValueType](#)
- typedef std::set< std::string > [ValuesType](#)

## Public Member Functions

- [StrictScanner](#) ()
- [~StrictScanner](#) () override
- void [AddPrivateTag](#) ([PrivateTag](#) const &t)
- void [AddSkipTag](#) ([Tag](#) const &t)
  - *Add a tag that will need to be skipped. Those are root level skip tags.*
- void [AddTag](#) ([Tag](#) const &t)
  - *Add a tag that will need to be read. Those are root level skip tags.*
- [ConstIterator](#) [Begin](#) () const
- void [ClearSkipTags](#) ()
- void [ClearTags](#) ()
- [ConstIterator](#) [End](#) () const
- [Directory::FilenamesType](#) [GetAllFilenamesFromTagToValue](#) ([Tag](#) const &t, const char \*valueref) const
- const char \* [GetFilenameFromTagToValue](#) ([Tag](#) const &t, const char \*valueref) const
- [Directory::FilenamesType](#) const & [GetFilenames](#) () const
- [Directory::FilenamesType](#) [GetKeys](#) () const
- [TagToValue](#) const & [GetMapping](#) (const char \*filename) const
  - *Get the std::map mapping filenames to value for file 'filename'.*
- [TagToValue](#) const & [GetMappingFromTagToValue](#) ([Tag](#) const &t, const char \*value) const
  - *See [GetFilenameFromTagToValue\(\)](#). This is simply [GetFilenameFromTagToValue](#) followed.*
- [MappingType](#) const & [GetMappings](#) () const
  - *Mappings are the mapping from a particular tag to the map, mapping filename to value:*
- [Directory::FilenamesType](#) [GetOrderedValues](#) ([Tag](#) const &t) const
- const char \* [GetValue](#) (const char \*filename, [Tag](#) const &t) const
- [ValuesType](#) const & [GetValues](#) () const
  - *Get all the values found (in lexicographic order)*
- [ValuesType](#) [GetValues](#) ([Tag](#) const &t) const
  - *Get all the values found (in lexicographic order) associated with [Tag](#) 't'.*
- bool [IsKey](#) (const char \*filename) const
- void [Print](#) (std::ostream &os) const override
  - *Print result.*
- void [PrintTable](#) (std::ostream &os) const
- bool [Scan](#) ([Directory::FilenamesType](#) const &filenames)
  - *Start the scan !*

## Static Public Member Functions

- static [SmartPointer](#)< [StrictScanner](#) > [New](#) ()
  - *for wrapped language: instantiate a reference counted object*

## Protected Member Functions

- void [ProcessPublicTag](#) ([StringFilter](#) &sf, const char \*filename)

## Friends

- std::ostream & [operator<<](#) (std::ostream &\_os, const [StrictScanner](#) &s)

### 10.290.1 Detailed Description

[StrictScanner](#).

This filter is meant for quickly browsing a [FileSet](#) (a set of files on disk). Special consideration are taken so as to read the minimum amount of information in each file in order to retrieve the user specified set of DICOM [Attribute](#).

This filter is dealing with both VRASCII and VRBINARY element, thanks to the help of [StringFilter](#)

#### Warning

IMPORTANT In case of file where tags are not ordered (illegal as per DICOM specification), the output will be missing information

#### Note

implementation details. All values are stored in a std::set of std::string. Then the address of the cstring underlying the std::string is used in the std::map.

This class implement the Subject/Observer pattern trigger the following events:

- [ProgressEvent](#)
- [StartEvent](#)
- [EndEvent](#)

#### Examples

[SimpleScanner.cxx](#).

### 10.290.2 Member Typedef Documentation

#### 10.290.2.1 ConstIterator

```
typedef MappingType::const_iterator gdcm::StrictScanner::ConstIterator
```

### 10.290.2.2 MappingType

```
typedef std::map<const char *, TagToValue, ltstr> gdcM::StrictScanner::MappingType
```

### 10.290.2.3 TagToValue

```
typedef std::map<Tag, const char*> gdcM::StrictScanner::TagToValue
```

struct to map a filename to a value Implementation note: all std::map in this class will be using const char \* and not std::string since we are pointing to existing std::string (hold in a std::vector) this avoid an extra copy of the byte array. Tag are used as Tag class since sizeof(tag) <= sizeof(pointer)

### 10.290.2.4 TagToValueValueType

```
typedef TagToValue::value_type gdcM::StrictScanner::TagToValueValueType
```

### 10.290.2.5 ValuesType

```
typedef std::set< std::string > gdcM::StrictScanner::ValuesType
```

## 10.290.3 Constructor & Destructor Documentation

### 10.290.3.1 StrictScanner()

```
gdcM::StrictScanner::StrictScanner ( ) [inline]
```

### 10.290.3.2 ~StrictScanner()

```
gdcM::StrictScanner::~~StrictScanner ( ) [override]
```

## 10.290.4 Member Function Documentation

#### 10.290.4.1 AddPrivateTag()

```
void gdcM::StrictScanner::AddPrivateTag (
    PrivateTag const & t )
```

#### 10.290.4.2 AddSkipTag()

```
void gdcM::StrictScanner::AddSkipTag (
    Tag const & t )
```

Add a tag that will need to be skipped. Those are root level skip tags.

#### 10.290.4.3 AddTag()

```
void gdcM::StrictScanner::AddTag (
    Tag const & t )
```

Add a tag that will need to be read. Those are root level skip tags.

#### Examples

[SimpleScanner.cxx](#).

#### 10.290.4.4 Begin()

```
ConstIterator gdcM::StrictScanner::Begin ( ) const [inline]
```

#### 10.290.4.5 ClearSkipTags()

```
void gdcM::StrictScanner::ClearSkipTags ( )
```

#### 10.290.4.6 ClearTags()

```
void gdcM::StrictScanner::ClearTags ( )
```

#### 10.290.4.7 End()

```
ConstIterator gdcmm::StrictScanner::End ( ) const [inline]
```

#### 10.290.4.8 GetAllFileNamesFromTagToValue()

```
Directory::FileNamesType gdcmm::StrictScanner::GetAllFileNamesFromTagToValue (
    Tag const & t,
    const char * valueref ) const
```

Will loop over all files and return a vector of std::strings of filenames where value match the reference value 'valueref'

#### 10.290.4.9 GetFilenameFromTagToValue()

```
const char* gdcmm::StrictScanner::GetFilenameFromTagToValue (
    Tag const & t,
    const char * valueref ) const
```

Will loop over all files and return the first file where value match the reference value 'valueref'

#### 10.290.4.10 GetFileNames()

```
Directory::FileNamesType const& gdcmm::StrictScanner::GetFileNames ( ) const [inline]
```

#### 10.290.4.11 GetKeys()

```
Directory::FileNamesType gdcmm::StrictScanner::GetKeys ( ) const
```

Return the list of filename that are key in the internal map, which means those filename were properly parsed

#### 10.290.4.12 GetMapping()

```
TagToValue const& gdcmm::StrictScanner::GetMapping (
    const char * filename ) const
```

Get the std::map mapping filenames to value for file 'filename'.

#### Examples

[SimpleScanner.cxx](#).

#### 10.290.4.13 GetMappingFromTagToValue()

```
TagToValue const& gdcM::StrictScanner::GetMappingFromTagToValue (
    Tag const & t,
    const char * value ) const
```

See [GetFilenameFromTagToValue\(\)](#). This is simply [GetFilenameFromTagToValue](#) followed.

#### 10.290.4.14 GetMappings()

```
MappingType const& gdcM::StrictScanner::GetMappings ( ) const [inline]
```

Mappings are the mapping from a particular tag to the map, mapping filename to value:

#### 10.290.4.15 GetOrderedValues()

```
Directory::FileNamesType gdcM::StrictScanner::GetOrderedValues (
    Tag const & t ) const
```

Get all the values found (in a vector) associated with [Tag](#) 't' This function is identical to [GetValues](#), but is accessible from the wrapped layer (python, C#, java)

#### 10.290.4.16 GetValue()

```
const char* gdcM::StrictScanner::GetValue (
    const char * filename,
    Tag const & t ) const
```

Retrieve the value found for tag: t associated with file: filename This is meant for a single short call. If multiple calls (multiple tags) should be done, prefer the [GetMapping](#) function, and then reuse the [TagToValue](#) hash table.

#### Warning

[Tag](#) 't' should have been added via [AddTag\(\)](#) prior to the [Scan\(\)](#) call !

#### 10.290.4.17 GetValues() [1/2]

```
ValuesType const& gdcM::StrictScanner::GetValues ( ) const [inline]
```

Get all the values found (in lexicographic order)

#### 10.290.4.18 GetValues() [2/2]

```
ValueType gdcM::StrictScanner::GetValues (
    Tag const & t ) const
```

Get all the values found (in lexicographic order) associated with [Tag](#) 't'.

#### 10.290.4.19 IsKey()

```
bool gdcM::StrictScanner::IsKey (
    const char * filename ) const
```

Check if filename is a key in the Mapping table. returns true only if file can be found, which means the file was indeed a DICOM file that could be processed

#### Examples

[SimpleScanner.cxx](#).

#### 10.290.4.20 New()

```
static SmartPointer<StrictScanner> gdcM::StrictScanner::New ( ) [inline], [static]
```

for wrapped language: instantiate a reference counted object

#### 10.290.4.21 Print()

```
void gdcM::StrictScanner::Print (
    std::ostream & os ) const [override], [virtual]
```

Print result.

Reimplemented from [gdcM::Object](#).

#### 10.290.4.22 PrintTable()

```
void gdcM::StrictScanner::PrintTable (
    std::ostream & os ) const
```

#### 10.290.4.23 ProcessPublicTag()

```
void gdcM::StrictScanner::ProcessPublicTag (
    StringFilter & sf,
    const char * filename ) [protected]
```

#### 10.290.4.24 Scan()

```
bool gdcM::StrictScanner::Scan (
    Directory::FileNamesType const & filenames )
```

Start the scan !

Examples

[SimpleScanner.cxx](#).

### 10.290.5 Friends And Related Function Documentation

#### 10.290.5.1 operator<<

```
std::ostream& operator<< (
    std::ostream & _os,
    const StrictScanner & s ) [friend]
```

The documentation for this class was generated from the following file:

- [gdcMStrictScanner.h](#)



## 10.291 gdcm::String< TDelimiter, TMaxLength, TPadChar > Class Template Reference

[String](#).

```
#include <gdcmString.h>
```

Inheritance diagram for gdcm::String< TDelimiter, TMaxLength, TPadChar >:

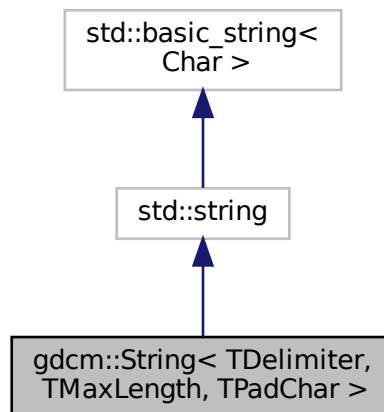

Collaboration diagram for gdcm::String< TDelimiter, TMaxLength, TPadChar >:

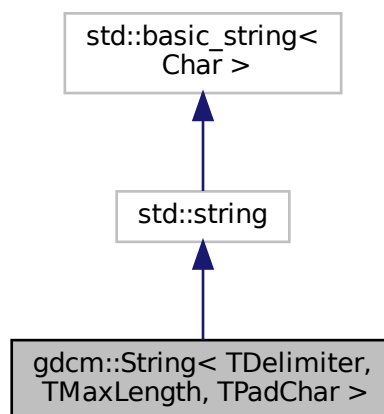

## Public Types

- typedef std::string::const\_iterator [const\\_iterator](#)
- typedef std::string::const\_reference [const\\_reference](#)
- typedef std::string::const\_reverse\_iterator [const\\_reverse\\_iterator](#)
- typedef std::string::difference\_type [difference\\_type](#)
- typedef std::string::iterator [iterator](#)
- typedef std::string::pointer [pointer](#)
- typedef std::string::reference [reference](#)
- typedef std::string::reverse\_iterator [reverse\\_iterator](#)
- typedef std::string::size\_type [size\\_type](#)
- typedef std::string::value\_type [value\\_type](#)

## Public Member Functions

- [String](#) ()  
*String constructors.*
- [String](#) (const std::string &s, [size\\_type](#) pos=0, [size\\_type](#) n=npos)
- [String](#) (const [value\\_type](#) \*s)
- [String](#) (const [value\\_type](#) \*s, [size\\_type](#) n)
- bool [IsValid](#) () const  
*return if string is valid*
- [operator const char \\*](#) () const  
*WARNING: Trailing \0 might be lost in this operation:*
- std::string [Trim](#) () const
- [gdcn::String](#)< TDelimiter, TMaxLength, TPadChar > [Truncate](#) () const

## Static Public Member Functions

- static std::string [Trim](#) (const char \*input)

### 10.291.1 Detailed Description

```
template<char TDelimiter = '\\', unsigned int TMaxLength = 64, char TPadChar = ' '>
class gdcn::String< TDelimiter, TMaxLength, TPadChar >
```

[String](#).

#### Note

TDelimiter template parameter is used to separate multiple [String](#) (VM1 >) TMaxLength is only a hint. No one actually respect the max length TPadChar is the string padding (0 or space)

#### Examples

[TemplateEmptyImage.cxx](#).

## 10.291.2 Member Typedef Documentation

### 10.291.2.1 const\_iterator

```
template<char TDelimiter = '\\', unsigned int TMaxLength = 64, char TPadChar = ' '>
typedef std::string::const_iterator gdcM::String< TDelimiter, TMaxLength, TPadChar >::const_iterator
```

### 10.291.2.2 const\_reference

```
template<char TDelimiter = '\\', unsigned int TMaxLength = 64, char TPadChar = ' '>
typedef std::string::const_reference gdcM::String< TDelimiter, TMaxLength, TPadChar >::const_reference
```

### 10.291.2.3 const\_reverse\_iterator

```
template<char TDelimiter = '\\', unsigned int TMaxLength = 64, char TPadChar = ' '>
typedef std::string::const_reverse_iterator gdcM::String< TDelimiter, TMaxLength, TPadChar >←
::const_reverse_iterator
```

### 10.291.2.4 difference\_type

```
template<char TDelimiter = '\\', unsigned int TMaxLength = 64, char TPadChar = ' '>
typedef std::string::difference_type gdcM::String< TDelimiter, TMaxLength, TPadChar >::difference_type
```

### 10.291.2.5 iterator

```
template<char TDelimiter = '\\', unsigned int TMaxLength = 64, char TPadChar = ' '>
typedef std::string::iterator gdcM::String< TDelimiter, TMaxLength, TPadChar >::iterator
```

### 10.291.2.6 pointer

```
template<char TDelimiter = '\\', unsigned int TMaxLength = 64, char TPadChar = ' '>
typedef std::string::pointer gdcm::String< TDelimiter, TMaxLength, TPadChar >::pointer
```

### 10.291.2.7 reference

```
template<char TDelimiter = '\\', unsigned int TMaxLength = 64, char TPadChar = ' '>
typedef std::string::reference gdcm::String< TDelimiter, TMaxLength, TPadChar >::reference
```

### 10.291.2.8 reverse\_iterator

```
template<char TDelimiter = '\\', unsigned int TMaxLength = 64, char TPadChar = ' '>
typedef std::string::reverse_iterator gdcm::String< TDelimiter, TMaxLength, TPadChar >::reverse\_iterator
```

### 10.291.2.9 size\_type

```
template<char TDelimiter = '\\', unsigned int TMaxLength = 64, char TPadChar = ' '>
typedef std::string::size_type gdcm::String< TDelimiter, TMaxLength, TPadChar >::size\_type
```

### 10.291.2.10 value\_type

```
template<char TDelimiter = '\\', unsigned int TMaxLength = 64, char TPadChar = ' '>
typedef std::string::value_type gdcm::String< TDelimiter, TMaxLength, TPadChar >::value\_type
```

## 10.291.3 Constructor & Destructor Documentation

### 10.291.3.1 String() [1/4]

```
template<char TDelimiter = '\\', unsigned int TMaxLength = 64, char TPadChar = ' '>
gdcm::String< TDelimiter, TMaxLength, TPadChar >::String ( ) [inline]
```

[String](#) constructors.

### 10.291.3.2 String() [2/4]

```
template<char TDelimiter = '\\', unsigned int TMaxLength = 64, char TPadChar = ' '>
gdcM::String< TDelimiter, TMaxLength, TPadChar >::String (
    const value_type * s ) [inline]
```

### 10.291.3.3 String() [3/4]

```
template<char TDelimiter = '\\', unsigned int TMaxLength = 64, char TPadChar = ' '>
gdcM::String< TDelimiter, TMaxLength, TPadChar >::String (
    const value_type * s,
    size_type n ) [inline]
```

### 10.291.3.4 String() [4/4]

```
template<char TDelimiter = '\\', unsigned int TMaxLength = 64, char TPadChar = ' '>
gdcM::String< TDelimiter, TMaxLength, TPadChar >::String (
    const std::string & s,
    size_type pos = 0,
    size_type n = npos ) [inline]
```

## 10.291.4 Member Function Documentation

### 10.291.4.1 IsValid()

```
template<char TDelimiter = '\\', unsigned int TMaxLength = 64, char TPadChar = ' '>
bool gdcM::String< TDelimiter, TMaxLength, TPadChar >::IsValid ( ) const [inline]
```

return if string is valid

Referenced by gdcM::LO::IsValid(), and gdcM::String< TDelimiter, TMaxLength, TPadChar >::Truncate().

### 10.291.4.2 operator const char \*()

```
template<char TDelimiter = '\\', unsigned int TMaxLength = 64, char TPadChar = ' '>
gdcM::String< TDelimiter, TMaxLength, TPadChar >::operator const char * ( ) const [inline]
```

WARNING: Trailing \0 might be lost in this operation:

### 10.291.4.3 Trim() [1/2]

```
template<char TDelimiter = '\\', unsigned int TMaxLength = 64, char TPadChar = ' '>
std::string gdcm::String< TDelimiter, TMaxLength, TPadChar >::Trim ( ) const [inline]
```

Trim function is required to return a std::string object, otherwise we could not create a [gdcm::String](#) object with an odd number of bytes...

#### Examples

[DumpExamCard.cxx](#), and [DumpPhilipsECHO.cxx](#).

### 10.291.4.4 Trim() [2/2]

```
template<char TDelimiter = '\\', unsigned int TMaxLength = 64, char TPadChar = ' '>
static std::string gdcm::String< TDelimiter, TMaxLength, TPadChar >::Trim (
    const char * input ) [inline], [static]
```

### 10.291.4.5 Truncate()

```
template<char TDelimiter = '\\', unsigned int TMaxLength = 64, char TPadChar = ' '>
gdcm::String<TDelimiter, TMaxLength, TPadChar> gdcm::String< TDelimiter, TMaxLength, TPadChar
>::Truncate ( ) const [inline]
```

References [gdcm::String< TDelimiter, TMaxLength, TPadChar >::IsValid\(\)](#).

The documentation for this class was generated from the following file:

- [gdcmString.h](#)

## 10.292 gdcm::StringFilter Class Reference

[StringFilter](#).

```
#include <gdcmStringFilter.h>
```

## Public Member Functions

- [StringFilter](#) ()
- [~StringFilter](#) ()
- bool [ExecuteQuery](#) (std::string const &query, std::string &value) const
- std::string [FromString](#) (const [Tag](#) &t, const char \*value, size\_t len)
  - Convert to string the char array defined by the pair (value,len)*
- [File](#) & [GetFile](#) ()
- const [File](#) & [GetFile](#) () const
- void [SetDicts](#) (const [Dicts](#) &dicts)
  - Allow user to pass in there own dicts.*
- void [SetFile](#) (const [File](#) &f)
  - Set/Get File.*
- std::string [ToString](#) (const [DataElement](#) &de) const
- std::string [ToString](#) (const [PrivateTag](#) &t) const
- std::string [ToString](#) (const [Tag](#) &t) const
  - Directly from a Tag:*
- std::pair< std::string, std::string > [ToStringPair](#) (const [DataElement](#) &de) const
- std::pair< std::string, std::string > [ToStringPair](#) (const [Tag](#) &t) const
  - Directly from a Tag:*
- void [UseDictAlways](#) (bool)

## Protected Member Functions

- bool [ExecuteQuery](#) (std::string const &query, [DataSet](#) const &ds, std::string &value) const
- std::pair< std::string, std::string > [ToStringPair](#) (const [Tag](#) &t, [DataSet](#) const &ds) const

### 10.292.1 Detailed Description

[StringFilter](#).

[StringFilter](#) is the class that make gdcm2.x looks more like gdcm1 and transform the binary blob contained in a [DataElement](#) into a string, typically this is a nice feature to have for wrapped language

Examples

[DumpVisusChange.cxx](#), and [ReadAndPrintAttributes.cxx](#).

### 10.292.2 Constructor & Destructor Documentation

#### 10.292.2.1 StringFilter()

```
gdcm::StringFilter::StringFilter ( )
```

### 10.292.2.2 ~StringFilter()

```
gdcM::StringFilter::~~StringFilter ( )
```

## 10.292.3 Member Function Documentation

### 10.292.3.1 ExecuteQuery() [1/2]

```
bool gdcM::StringFilter::ExecuteQuery (
    std::string const & query,
    DataSet const & ds,
    std::string & value ) const [protected]
```

### 10.292.3.2 ExecuteQuery() [2/2]

```
bool gdcM::StringFilter::ExecuteQuery (
    std::string const & query,
    std::string & value ) const
```

Execute the XPATH query to find a value (as string) return false when attribute is not found (or an error in the XPATH query) You need to make sure that your XPATH query is syntatically correct

### 10.292.3.3 FromString()

```
std::string gdcM::StringFilter::FromString (
    const Tag & t,
    const char * value,
    size_t len )
```

Convert to string the char array defined by the pair (value,len)

### 10.292.3.4 GetFile() [1/2]

```
File& gdcM::StringFilter::GetFile ( ) [inline]
```



### 10.292.3.5 GetFile() [2/2]

```
const File& gdcM::StringFilter::GetFile ( ) const [inline]
```

### 10.292.3.6 SetDicts()

```
void gdcM::StringFilter::SetDicts (
    const Dicts & dicts )
```

Allow user to pass in there own dicts.

### 10.292.3.7 SetFile()

```
void gdcM::StringFilter::SetFile (
    const File & f ) [inline]
```

Set/Get [File](#).

#### Examples

[DumpVisusChange.cxx](#), [ReadAndPrintAttributes.cxx](#), and [SimplePrintPatientName.cs](#).

### 10.292.3.8 ToString() [1/3]

```
std::string gdcM::StringFilter::ToString (
    const DataElement & de ) const
```

Convert to string the [ByteValue](#) contained in a [DataElement](#). The [DataElement](#) must be coming from the actual [DataSet](#) associated with [File](#) (see [SetFile](#)).

#### Examples

[DumpVisusChange.cxx](#), and [ReadAndPrintAttributes.cxx](#).

### 10.292.3.9 ToString() [2/3]

```
std::string gdcM::StringFilter::ToString (
    const PrivateTag & t ) const
```

### 10.292.3.10 ToString() [3/3]

```
std::string gdcM::StringFilter::ToString (
    const Tag & t ) const
```

Directly from a [Tag](#):

### 10.292.3.11 ToStringPair() [1/3]

```
std::pair<std::string, std::string> gdcM::StringFilter::ToStringPair (
    const DataElement & de ) const
```

Convert to string the [ByteValue](#) contained in a [DataElement](#) the returned elements are: pair.first : the name as found in the dictionary of [DataElement](#) pair.second : the value encoded into a string (US,UL...) are properly converted

#### Examples

[ReadAndPrintAttributes.cxx](#).

### 10.292.3.12 ToStringPair() [2/3]

```
std::pair<std::string, std::string> gdcM::StringFilter::ToStringPair (
    const Tag & t ) const
```

Directly from a [Tag](#):

### 10.292.3.13 ToStringPair() [3/3]

```
std::pair<std::string, std::string> gdcM::StringFilter::ToStringPair (
    const Tag & t,
    DataSet const & ds ) const [protected]
```

### 10.292.3.14 UseDictAlways()

```
void gdcM::StringFilter::UseDictAlways (
    bool ) [inline]
```

The documentation for this class was generated from the following file:

- [gdcMStringFilter.h](#)

## 10.293 gdcm::Study Class Reference

[Study.](#)

```
#include <gdcmStudy.h>
```

### Public Member Functions

- [Study](#) ()=default

### 10.293.1 Detailed Description

[Study.](#)

### 10.293.2 Constructor & Destructor Documentation

#### 10.293.2.1 Study()

```
gdcm::Study::Study ( ) [default]
```

The documentation for this class was generated from the following file:

- [gdcmStudy.h](#)

## 10.294 gdcm::Subject Class Reference

[Subject.](#)

```
#include <gdcmSubject.h>
```

Inheritance diagram for `gdc::Subject`:

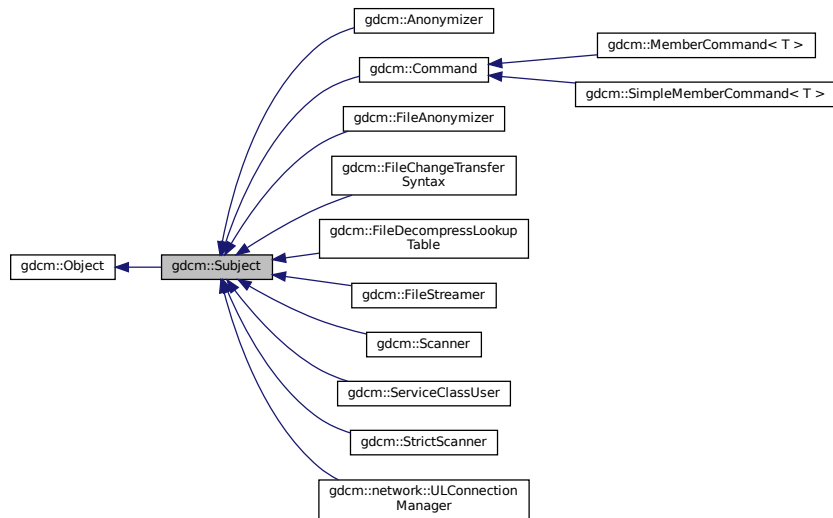

Collaboration diagram for `gdc::Subject`:

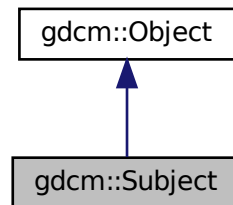

## Public Member Functions

- `Subject ()`
- `~Subject ()` override
- `unsigned long AddObserver (const Event &event, Command *)`
- `unsigned long AddObserver (const Event &event, Command *) const`
- `Command * GetCommand (unsigned long tag)`
- `bool HasObserver (const Event &event) const`
- `void InvokeEvent (const Event &)`
- `void InvokeEvent (const Event &) const`
- `void RemoveAllObservers ()`
- `void RemoveObserver (unsigned long tag)`

## Additional Inherited Members

### 10.294.1 Detailed Description

[Subject](#).

See also

[Command Event](#)

Examples

[SimpleScanner.cxx](#).

### 10.294.2 Constructor & Destructor Documentation

#### 10.294.2.1 Subject()

```
gdcM::Subject::Subject ( )
```

#### 10.294.2.2 ~Subject()

```
gdcM::Subject::~~Subject ( ) [override]
```

### 10.294.3 Member Function Documentation

#### 10.294.3.1 AddObserver() [1/2]

```
unsigned long gdcM::Subject::AddObserver (
    const Event & event,
    Command * )
```

Allow people to add/remove/invoke observers (callbacks) to any GDCM object. This is an implementation of the subject/observer design pattern. An observer is added by specifying an event to respond to and an [gdcM::Command](#) to execute. It returns an unsigned long tag which can be used later to remove the event or retrieve the command. The memory for the [Command](#) becomes the responsibility of this object, so don't pass the same instance of a command to two different objects

### 10.294.3.2 AddObserver() [2/2]

```
unsigned long gdcM::Subject::AddObserver (
    const Event & event,
    Command * ) const
```

### 10.294.3.3 GetCommand()

```
Command* gdcM::Subject::GetCommand (
    unsigned long tag )
```

Get the command associated with the given tag. NOTE: This returns a pointer to a [Command](#), but it is safe to assign this to a [Command::Pointer](#). Since [Command](#) inherits from [LightObject](#), at this point in the code, only a pointer or a reference to the [Command](#) can be used.

### 10.294.3.4 HasObserver()

```
bool gdcM::Subject::HasObserver (
    const Event & event ) const
```

Return true if an observer is registered for this event.

### 10.294.3.5 InvokeEvent() [1/2]

```
void gdcM::Subject::InvokeEvent (
    const Event & )
```

Call Execute on all the Commands observing this event id.

### 10.294.3.6 InvokeEvent() [2/2]

```
void gdcM::Subject::InvokeEvent (
    const Event & ) const
```

Call Execute on all the Commands observing this event id. The actions triggered by this call doesn't modify this object.

### 10.294.3.7 RemoveAllObservers()

```
void gdcM::Subject::RemoveAllObservers ( )
```

Remove all observers .

### 10.294.3.8 RemoveObserver()

```
void gdcM::Subject::RemoveObserver (
    unsigned long tag )
```

Remove the observer with this tag value.

The documentation for this class was generated from the following file:

- [gdcMSubject.h](#)

## 10.295 gdcM::Surface Class Reference

This class defines a SURFACE IE.

```
#include <gdcMSurface.h>
```

Inheritance diagram for gdcM::Surface:

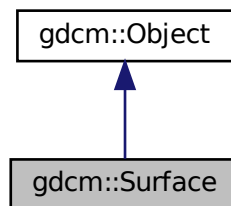

Collaboration diagram for gdcM::Surface:

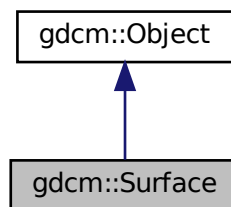

## Public Types

- enum [STATES](#) {  
[NO](#) = 0 ,  
[YES](#) ,  
[UNKNOWN](#) ,  
[STATES\\_END](#) }
- enum [VIEWType](#) {  
[SURFACE](#) = 0 ,  
[WIREFRAME](#) ,  
[POINTS](#) ,  
[VIEWType\\_END](#) }

*Enumeration for Recommended Presentation Type.*

## Public Member Functions

- [Surface](#) ()
- [~Surface](#) () override
- [SegmentHelper::BasicCodedEntry](#) & [GetAlgorithmFamily](#) ()
- [SegmentHelper::BasicCodedEntry](#) const & [GetAlgorithmFamily](#) () const
- const char \* [GetAlgorithmName](#) () const
- const char \* [GetAlgorithmVersion](#) () const
- const float \* [GetAxisOfRotation](#) () const
- const float \* [GetCenterOfRotation](#) () const
- [STATES](#) [GetFiniteVolume](#) () const
- [STATES](#) [GetManifold](#) () const
- float [GetMaximumPointDistance](#) () const
- float [GetMeanPointDistance](#) () const
- [MeshPrimitive](#) & [GetMeshPrimitive](#) ()
- [MeshPrimitive](#) const & [GetMeshPrimitive](#) () const
- unsigned long [GetNumberOfSurfacePoints](#) () const
- unsigned long [GetNumberOfVectors](#) () const
- [DataElement](#) & [GetPointCoordinatesData](#) ()
- const [DataElement](#) & [GetPointCoordinatesData](#) () const
- const float \* [GetPointPositionAccuracy](#) () const
- const float \* [GetPointsBoundingBoxCoordinates](#) () const
- [SegmentHelper::BasicCodedEntry](#) & [GetProcessingAlgorithm](#) ()
- [SegmentHelper::BasicCodedEntry](#) const & [GetProcessingAlgorithm](#) () const
- const unsigned short \* [GetRecommendedDisplayCIELabValue](#) () const
- unsigned short [GetRecommendedDisplayCIELabValue](#) (const unsigned int idx) const
- unsigned short [GetRecommendedDisplayGrayscaleValue](#) () const
- float [GetRecommendedPresentationOpacity](#) () const
- [VIEWType](#) [GetRecommendedPresentationType](#) () const
- const char \* [GetSurfaceComments](#) () const
- unsigned long [GetSurfaceNumber](#) () const
- bool [GetSurfaceProcessing](#) () const
- const char \* [GetSurfaceProcessingDescription](#) () const
- float [GetSurfaceProcessingRatio](#) () const
- const float \* [GetVectorAccuracy](#) () const
- [DataElement](#) & [GetVectorCoordinateData](#) ()



- const [DataElement](#) & [GetVectorCoordinateData](#) () const
- unsigned short [GetVectorDimensionality](#) () const
- void [SetAlgorithmFamily](#) ([SegmentHelper::BasicCodedEntry](#) const &BSE)
- void [SetAlgorithmName](#) (const char \*str)
- void [SetAlgorithmVersion](#) (const char \*str)
- void [SetAxisOfRotation](#) (const float \*axis)
- void [SetCenterOfRotation](#) (const float \*center)
- void [SetFiniteVolume](#) ([STATES](#) state)
- void [SetManifold](#) ([STATES](#) state)
- void [SetMaximumPointDistance](#) (float maximum)
- void [SetMeanPointDistance](#) (float average)
- void [SetMeshPrimitive](#) ([MeshPrimitive](#) &mp)
- void [SetNumberOfSurfacePoints](#) (const unsigned long nb)
- void [SetNumberOfVectors](#) (const unsigned long nb)
- void [SetPointCoordinatesData](#) ([DataElement](#) const &de)
- void [SetPointPositionAccuracy](#) (const float \*accuracies)
- void [SetPointsBoundingBoxCoordinates](#) (const float \*coordinates)
- void [SetProcessingAlgorithm](#) ([SegmentHelper::BasicCodedEntry](#) const &BSE)
- void [SetRecommendedDisplayCIELabValue](#) (const std::vector< unsigned short > &vl)
- void [SetRecommendedDisplayCIELabValue](#) (const unsigned short vl, const unsigned int idx=0)
- void [SetRecommendedDisplayCIELabValue](#) (const unsigned short vl[3])
- void [SetRecommendedDisplayGrayscaleValue](#) (const unsigned short vl)
- void [SetRecommendedPresentationOpacity](#) (const float opacity)
- void [SetRecommendedPresentationType](#) ([VIEWType](#) type)
- void [SetSurfaceComments](#) (const char \*comment)
- void [SetSurfaceNumber](#) (const unsigned long nb)
- void [SetSurfaceProcessing](#) (bool b)
- void [SetSurfaceProcessingDescription](#) (const char \*description)
- void [SetSurfaceProcessingRatio](#) (const float ratio)
- void [SetVectorAccuracy](#) (const float \*accuracy)
- void [SetVectorCoordinateData](#) ([DataElement](#) const &de)
- void [SetVectorDimensionality](#) (const unsigned short dim)

## Static Public Member Functions

- static [STATES](#) [GetSTATES](#) (const char \*state)
- static const char \* [GetSTATESString](#) ([STATES](#) state)
- static [VIEWType](#) [GetVIEWType](#) (const char \*type)
- static const char \* [GetVIEWTypeString](#) ([VIEWType](#) type)

## Additional Inherited Members

### 10.295.1 Detailed Description

This class defines a SURFACE IE.

This members are taken from required surface mesh module attributes.

See also

PS 3.3 A.1.2.18 , A.57 and C.27

## 10.295.2 Member Enumeration Documentation

### 10.295.2.1 STATES

enum `gdcm::Surface::STATES`

#### Enumerator

NO	
YES	
UNKNOWN	
STATES_END	

### 10.295.2.2 VIEWType

enum `gdcm::Surface::VIEWType`

Enumeration for Recommended Presentation [Type](#).

#### See also

Tag(0x0066, 0x000D) and PS 3.3 C.27.1.1.3

#### Enumerator

SURFACE	
WIREFRAME	
POINTS	
VIEWType_END	

## 10.295.3 Constructor & Destructor Documentation

### 10.295.3.1 Surface()

`gdcm::Surface::Surface ( )`

### 10.295.3.2 ~Surface()

```
gdcm::Surface::~~Surface ( ) [override]
```

## 10.295.4 Member Function Documentation

### 10.295.4.1 GetAlgorithmFamily() [1/2]

```
SegmentHelper::BasicCodedEntry& gdcm::Surface::GetAlgorithmFamily ( )
```

### 10.295.4.2 GetAlgorithmFamily() [2/2]

```
SegmentHelper::BasicCodedEntry const& gdcm::Surface::GetAlgorithmFamily ( ) const
```

### 10.295.4.3 GetAlgorithmName()

```
const char* gdcm::Surface::GetAlgorithmName ( ) const
```

### 10.295.4.4 GetAlgorithmVersion()

```
const char* gdcm::Surface::GetAlgorithmVersion ( ) const
```

### 10.295.4.5 GetAxisOfRotation()

```
const float* gdcm::Surface::GetAxisOfRotation ( ) const
```

#### Note

Pointer is null if undefined

#### 10.295.4.6 GetCenterOfRotation()

```
const float* gdcm::Surface::GetCenterOfRotation ( ) const
```

##### Note

Pointer is null if undefined

#### 10.295.4.7 GetFiniteVolume()

```
STATES gdcm::Surface::GetFiniteVolume ( ) const
```

#### 10.295.4.8 GetManifold()

```
STATES gdcm::Surface::GetManifold ( ) const
```

#### 10.295.4.9 GetMaximumPointDistance()

```
float gdcm::Surface::GetMaximumPointDistance ( ) const
```

#### 10.295.4.10 GetMeanPointDistance()

```
float gdcm::Surface::GetMeanPointDistance ( ) const
```

#### 10.295.4.11 GetMeshPrimitive() [1/2]

```
MeshPrimitive& gdcm::Surface::GetMeshPrimitive ( )
```

**10.295.4.12 GetMeshPrimitive()** [2/2]

```
MeshPrimitive const& gdcM::Surface::GetMeshPrimitive ( ) const
```

**10.295.4.13 GetNumberOfSurfacePoints()**

```
unsigned long gdcM::Surface::GetNumberOfSurfacePoints ( ) const
```

**10.295.4.14 GetNumberOfVectors()**

```
unsigned long gdcM::Surface::GetNumberOfVectors ( ) const
```

**10.295.4.15 GetPointCoordinatesData()** [1/2]

```
DataElement& gdcM::Surface::GetPointCoordinatesData ( )
```

**10.295.4.16 GetPointCoordinatesData()** [2/2]

```
const DataElement& gdcM::Surface::GetPointCoordinatesData ( ) const
```

**10.295.4.17 GetPointPositionAccuracy()**

```
const float* gdcM::Surface::GetPointPositionAccuracy ( ) const
```

**Note**

Pointer is null if undefined

**10.295.4.18 GetPointsBoundingBoxCoordinates()**

```
const float* gdcM::Surface::GetPointsBoundingBoxCoordinates ( ) const
```

**Note**

Pointer is null if undefined

**10.295.4.19 GetProcessingAlgorithm() [1/2]**

```
SegmentHelper::BasicCodedEntry& gdcM::Surface::GetProcessingAlgorithm ( )
```

**10.295.4.20 GetProcessingAlgorithm() [2/2]**

```
SegmentHelper::BasicCodedEntry const& gdcM::Surface::GetProcessingAlgorithm ( ) const
```

**10.295.4.21 GetRecommendedDisplayCIELabValue() [1/2]**

```
const unsigned short* gdcM::Surface::GetRecommendedDisplayCIELabValue ( ) const
```

**10.295.4.22 GetRecommendedDisplayCIELabValue() [2/2]**

```
unsigned short gdcM::Surface::GetRecommendedDisplayCIELabValue (
    const unsigned int idx ) const
```

**10.295.4.23 GetRecommendedDisplayGrayscaleValue()**

```
unsigned short gdcM::Surface::GetRecommendedDisplayGrayscaleValue ( ) const
```

#### 10.295.4.24 GetRecommendedPresentationOpacity()

```
float gdcm::Surface::GetRecommendedPresentationOpacity ( ) const
```

#### 10.295.4.25 GetRecommendedPresentationType()

```
VIEWType gdcm::Surface::GetRecommendedPresentationType ( ) const
```

#### 10.295.4.26 GetSTATES()

```
static STATES gdcm::Surface::GetSTATES (
    const char * state ) [static]
```

#### 10.295.4.27 GetSTATESString()

```
static const char* gdcm::Surface::GetSTATESString (
    STATES state ) [static]
```

#### 10.295.4.28 GetSurfaceComments()

```
const char* gdcm::Surface::GetSurfaceComments ( ) const
```

#### 10.295.4.29 GetSurfaceNumber()

```
unsigned long gdcm::Surface::GetSurfaceNumber ( ) const
```

#### 10.295.4.30 GetSurfaceProcessing()

```
bool gdcm::Surface::GetSurfaceProcessing ( ) const
```

**10.295.4.31 GetSurfaceProcessingDescription()**

```
const char* gdcm::Surface::GetSurfaceProcessingDescription ( ) const
```

**10.295.4.32 GetSurfaceProcessingRatio()**

```
float gdcm::Surface::GetSurfaceProcessingRatio ( ) const
```

**10.295.4.33 GetVectorAccuracy()**

```
const float* gdcm::Surface::GetVectorAccuracy ( ) const
```

**10.295.4.34 GetVectorCoordinateData() [1/2]**

```
DataElement& gdcm::Surface::GetVectorCoordinateData ( )
```

**10.295.4.35 GetVectorCoordinateData() [2/2]**

```
const DataElement& gdcm::Surface::GetVectorCoordinateData ( ) const
```

**10.295.4.36 GetVectorDimensionality()**

```
unsigned short gdcm::Surface::GetVectorDimensionality ( ) const
```

**10.295.4.37 GetVIEWType()**

```
static VIEWType gdcm::Surface::GetVIEWType (
    const char * type ) [static]
```



#### 10.295.4.38 GetVIEWTypeString()

```
static const char* gdcM::Surface::GetVIEWTypeString (
    VIEWType type ) [static]
```

#### 10.295.4.39 SetAlgorithmFamily()

```
void gdcM::Surface::SetAlgorithmFamily (
    SegmentHelper::BasicCodedEntry const & BSE )
```

#### 10.295.4.40 SetAlgorithmName()

```
void gdcM::Surface::SetAlgorithmName (
    const char * str )
```

#### 10.295.4.41 SetAlgorithmVersion()

```
void gdcM::Surface::SetAlgorithmVersion (
    const char * str )
```

#### 10.295.4.42 SetAxisOfRotation()

```
void gdcM::Surface::SetAxisOfRotation (
    const float * axis )
```

#### 10.295.4.43 SetCenterOfRotation()

```
void gdcM::Surface::SetCenterOfRotation (
    const float * center )
```

**10.295.4.44 SetFiniteVolume()**

```
void gdcM::Surface::SetFiniteVolume (
    STATES state )
```

**10.295.4.45 SetManifold()**

```
void gdcM::Surface::SetManifold (
    STATES state )
```

**10.295.4.46 SetMaximumPointDistance()**

```
void gdcM::Surface::SetMaximumPointDistance (
    float maximum )
```

**10.295.4.47 SetMeanPointDistance()**

```
void gdcM::Surface::SetMeanPointDistance (
    float average )
```

**10.295.4.48 SetMeshPrimitive()**

```
void gdcM::Surface::SetMeshPrimitive (
    MeshPrimitive & mp )
```

**10.295.4.49 SetNumberOfSurfacePoints()**

```
void gdcM::Surface::SetNumberOfSurfacePoints (
    const unsigned long nb )
```

**10.295.4.50 SetNumberOfVectors()**

```
void gdcM::Surface::SetNumberOfVectors (
    const unsigned long nb )
```

**10.295.4.51 SetPointCoordinatesData()**

```
void gdcM::Surface::SetPointCoordinatesData (
    DataElement const & de )
```

**10.295.4.52 SetPointPositionAccuracy()**

```
void gdcM::Surface::SetPointPositionAccuracy (
    const float * accuracies )
```

**10.295.4.53 SetPointsBoundingBoxCoordinates()**

```
void gdcM::Surface::SetPointsBoundingBoxCoordinates (
    const float * coordinates )
```

**10.295.4.54 SetProcessingAlgorithm()**

```
void gdcM::Surface::SetProcessingAlgorithm (
    SegmentHelper::BasicCodedEntry const & BSE )
```

**10.295.4.55 SetRecommendedDisplayCIELabValue() [1/3]**

```
void gdcM::Surface::SetRecommendedDisplayCIELabValue (
    const std::vector< unsigned short > & vl )
```

**10.295.4.56 SetRecommendedDisplayCIELabValue()** [2/3]

```
void gdcM::Surface::SetRecommendedDisplayCIELabValue (
    const unsigned short v1,
    const unsigned int idx = 0 )
```

**10.295.4.57 SetRecommendedDisplayCIELabValue()** [3/3]

```
void gdcM::Surface::SetRecommendedDisplayCIELabValue (
    const unsigned short v1[3] )
```

**10.295.4.58 SetRecommendedDisplayGrayscaleValue()**

```
void gdcM::Surface::SetRecommendedDisplayGrayscaleValue (
    const unsigned short v1 )
```

**10.295.4.59 SetRecommendedPresentationOpacity()**

```
void gdcM::Surface::SetRecommendedPresentationOpacity (
    const float opacity )
```

**10.295.4.60 SetRecommendedPresentationType()**

```
void gdcM::Surface::SetRecommendedPresentationType (
    VIEWType type )
```

**10.295.4.61 SetSurfaceComments()**

```
void gdcM::Surface::SetSurfaceComments (
    const char * comment )
```

**10.295.4.62 SetSurfaceNumber()**

```
void gdcM::Surface::SetSurfaceNumber (
    const unsigned long nb )
```

**10.295.4.63 SetSurfaceProcessing()**

```
void gdcM::Surface::SetSurfaceProcessing (
    bool b )
```

**10.295.4.64 SetSurfaceProcessingDescription()**

```
void gdcM::Surface::SetSurfaceProcessingDescription (
    const char * description )
```

**10.295.4.65 SetSurfaceProcessingRatio()**

```
void gdcM::Surface::SetSurfaceProcessingRatio (
    const float ratio )
```

**10.295.4.66 SetVectorAccuracy()**

```
void gdcM::Surface::SetVectorAccuracy (
    const float * accuracy )
```

**10.295.4.67 SetVectorCoordinateData()**

```
void gdcM::Surface::SetVectorCoordinateData (
    DataElement const & de )
```

### 10.295.4.68 SetVectorDimensionality()

```
void gdcmm::Surface::SetVectorDimensionality (
    const unsigned short dim )
```

The documentation for this class was generated from the following file:

- [gdcmmSurface.h](#)

## 10.296 gdcmm::SurfaceHelper Class Reference

[SurfaceHelper](#).

```
#include <gdcmmSurfaceHelper.h>
```

### Public Types

- typedef std::vector< unsigned short > [ColorArray](#)

### Static Public Member Functions

- template<typename T , typename U >  
static std::vector< T > [RecommendedDisplayCIELabToRGB](#) (const [ColorArray](#) &CIELab, const U range↔Max=255)  
*Convert a DICOM CIE-Lab (after reading) color into RGB.*
- template<typename U >  
static std::vector< float > [RecommendedDisplayCIELabToRGB](#) (const [ColorArray](#) &CIELab, const U range↔Max=255)  
*Convert a DICOM CIE-Lab (after reading) color into RGB.*
- template<typename T , typename U >  
static [ColorArray](#) [RGBToRecommendedDisplayCIELab](#) (const std::vector< T > &RGB, const U rangeMax=255)  
*Convert a RGB color into DICOM CIE-Lab (ready to write).*
- template<typename T , typename U >  
static unsigned short [RGBToRecommendedDisplayGrayscale](#) (const std::vector< T > &RGB, const U range↔Max=255)  
*Convert a RGB color into DICOM grayscale (ready to write).*

### 10.296.1 Detailed Description

[SurfaceHelper](#).

Helper class for [Surface](#) object

## 10.296.2 Member Typedef Documentation

### 10.296.2.1 ColorArray

```
typedef std::vector< unsigned short > gdcm::SurfaceHelper::ColorArray
```

## 10.296.3 Member Function Documentation

### 10.296.3.1 RecommendedDisplayCIELabToRGB() [1/2]

```
template<typename T , typename U >
std::vector< T > gdcm::SurfaceHelper::RecommendedDisplayCIELabToRGB (
    const ColorArray & CIELab,
    const U rangeMax = 255 ) [static]
```

Convert a DICOM CIE-Lab (after reading) color into RGB.

See also

PS 3.3 C.10.7.1.1

Parameters

<i>CIELab</i>	DICOM CIE-Lab array.
<i>rangeMax</i>	Max value of the RGB range.

Template Parameters

<i>T</i>	Type of CIELab components.
<i>U</i>	Type of rangeMax value.

### 10.296.3.2 RecommendedDisplayCIELabToRGB() [2/2]

```
template<typename U >
std::vector< float > gdcm::SurfaceHelper::RecommendedDisplayCIELabToRGB (
```

```
const ColorArray & CIELab,
const U rangeMax = 255 ) [static]
```

Convert a DICOM CIE-Lab (after reading) color into RGB.

#### See also

PS 3.3 C.10.7.1.1

#### Parameters

<i>CIELab</i>	DICOM CIE-Lab array.
<i>rangeMax</i>	Max value of the RGB range.

#### Template Parameters

<i>U</i>	Type of rangeMax value.
----------	-------------------------

### 10.296.3.3 RGBToRecommendedDisplayCIELab()

```
template<typename T , typename U >
SurfaceHelper::ColorArray gdcM::SurfaceHelper::RGBToRecommendedDisplayCIELab (
    const std::vector< T > & RGB,
    const U rangeMax = 255 ) [static]
```

Convert a RGB color into DICOM CIE-Lab (ready to write).

#### See also

PS 3.3 C.10.7.1.1

#### Parameters

<i>RGB</i>	RGB array.
<i>rangeMax</i>	Max value of the RGB range.

#### Template Parameters

<i>T</i>	Type of RGB components.
<i>U</i>	Type of rangeMax value.



### 10.296.3.4 RGBToRecommendedDisplayGrayscale()

```
template<typename T , typename U >
unsigned short gdcm::SurfaceHelper::RGBToRecommendedDisplayGrayscale (
    const std::vector< T > & RGB,
    const U rangeMax = 255 ) [static]
```

Convert a RGB color into DICOM grayscale (ready to write).

#### See also

PS 3.3 C.27.1 tag(0062,000C)

#### Parameters

<i>RGB</i>	RGB array.
<i>rangeMax</i>	Max value of the RGB range.

#### Template Parameters

<i>T</i>	Type of RGB components.
<i>U</i>	Type of rangeMax value.

The documentation for this class was generated from the following file:

- [gdcmSurfaceHelper.h](#)

## 10.297 gdcm::SurfaceReader Class Reference

This class defines a SURFACE IE reader.

```
#include <gdcmSurfaceReader.h>
```

Inheritance diagram for `gdcM::SurfaceReader`:

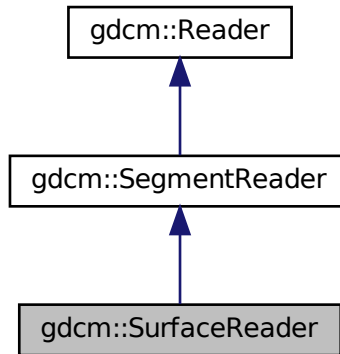

Collaboration diagram for `gdcM::SurfaceReader`:

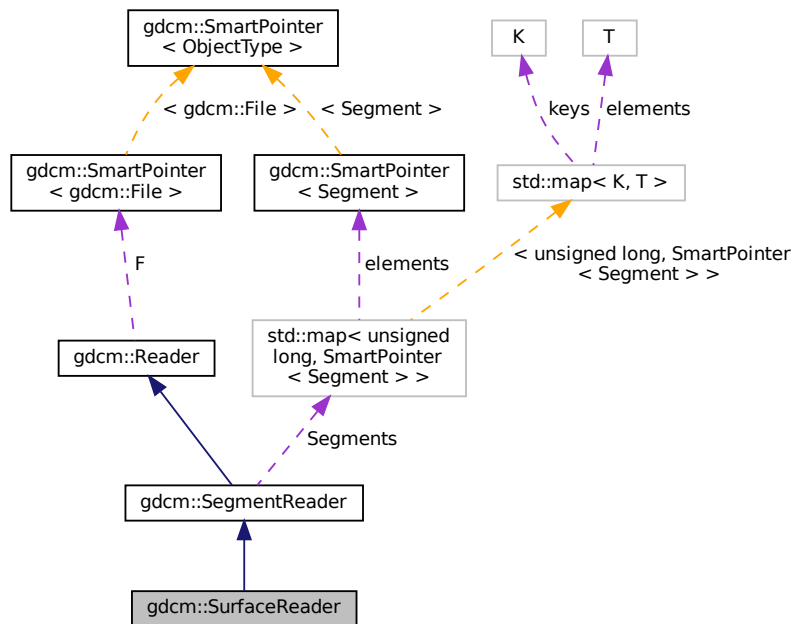

## Public Member Functions

- [SurfaceReader](#) ()

- [~SurfaceReader](#) () override
  - unsigned long [GetNumberOfSurfaces](#) () const
  - bool [Read](#) () override
- Read.*

## Protected Member Functions

- bool [ReadPointMacro](#) ([SmartPointer](#)< [Surface](#) > surface, const [DataSet](#) &surfaceDS)
- bool [ReadSurface](#) (const [Item](#) &surfItem, const unsigned long idx)
- bool [ReadSurfaces](#) ()

## Additional Inherited Members

### 10.297.1 Detailed Description

This class defines a SURFACE IE reader.

It reads surface mesh module attributes.

See also

PS 3.3 A.1.2.18 , A.57 and C.27

### 10.297.2 Constructor & Destructor Documentation

#### 10.297.2.1 SurfaceReader()

```
gdcm::SurfaceReader::SurfaceReader ( )
```

#### 10.297.2.2 ~SurfaceReader()

```
gdcm::SurfaceReader::~~SurfaceReader ( ) [override]
```

### 10.297.3 Member Function Documentation

### 10.297.3.1 GetNumberOfSurfaces()

```
unsigned long gdcM::SurfaceReader::GetNumberOfSurfaces ( ) const
```

### 10.297.3.2 Read()

```
bool gdcM::SurfaceReader::Read ( ) [override], [virtual]
```

Read.

Reimplemented from [gdcM::SegmentReader](#).

### 10.297.3.3 ReadPointMacro()

```
bool gdcM::SurfaceReader::ReadPointMacro (
    SmartPointer< Surface > surface,
    const DataSet & surfaceDS ) [protected]
```

### 10.297.3.4 ReadSurface()

```
bool gdcM::SurfaceReader::ReadSurface (
    const Item & surfaceItem,
    const unsigned long idx ) [protected]
```

### 10.297.3.5 ReadSurfaces()

```
bool gdcM::SurfaceReader::ReadSurfaces ( ) [protected]
```

The documentation for this class was generated from the following file:

- [gdcMSurfaceReader.h](#)

## 10.298 gdcm::SurfaceWriter Class Reference

This class defines a SURFACE IE writer.

```
#include <gdcmSurfaceWriter.h>
```

Inheritance diagram for gdcm::SurfaceWriter:

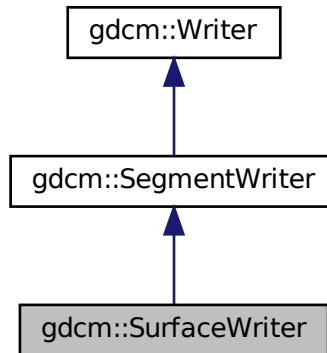

Collaboration diagram for gdcm::SurfaceWriter:

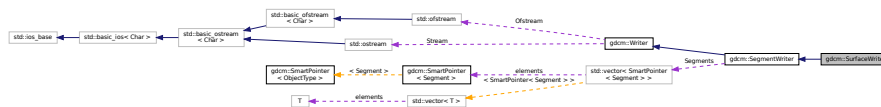

### Public Member Functions

- [SurfaceWriter](#) ()
- [~SurfaceWriter](#) () override
- unsigned long [GetNumberOfSurfaces](#) ()
- void [SetNumberOfSurfaces](#) (const unsigned long nb)
- bool [Write](#) () override

*Write.*

### Protected Member Functions

- void [ComputeNumberOfSurfaces](#) ()
- bool [PrepareWrite](#) ()
- bool [PrepareWritePointMacro](#) (SmartPointer< Surface > surface, DataSet &surfaceDS, const TransferSyntax &ts)

## Protected Attributes

- unsigned long [NumberOfSurfaces](#)

## Additional Inherited Members

### 10.298.1 Detailed Description

This class defines a SURFACE IE writer.

It writes surface mesh module attributes.

See also

PS 3.3 A.1.2.18 , A.57 and C.27

### 10.298.2 Constructor & Destructor Documentation

#### 10.298.2.1 SurfaceWriter()

```
gdcM::SurfaceWriter::SurfaceWriter ( )
```

#### 10.298.2.2 ~SurfaceWriter()

```
gdcM::SurfaceWriter::~~SurfaceWriter ( ) [override]
```

### 10.298.3 Member Function Documentation

#### 10.298.3.1 ComputeNumberOfSurfaces()

```
void gdcM::SurfaceWriter::ComputeNumberOfSurfaces ( ) [protected]
```

### 10.298.3.2 GetNumberOfSurfaces()

```
unsigned long gdcm::SurfaceWriter::GetNumberOfSurfaces ( )
```

### 10.298.3.3 PrepareWrite()

```
bool gdcm::SurfaceWriter::PrepareWrite ( ) [protected]
```

### 10.298.3.4 PrepareWritePointMacro()

```
bool gdcm::SurfaceWriter::PrepareWritePointMacro (
    SmartPointer< Surface > surface,
    DataSet & surfaceDS,
    const TransferSyntax & ts ) [protected]
```

### 10.298.3.5 SetNumberOfSurfaces()

```
void gdcm::SurfaceWriter::SetNumberOfSurfaces (
    const unsigned long nb )
```

### 10.298.3.6 Write()

```
bool gdcm::SurfaceWriter::Write ( ) [override], [virtual]
```

Write.

Reimplemented from [gdcm::SegmentWriter](#).

## 10.298.4 Member Data Documentation

### 10.298.4.1 NumberOfSurfaces

```
unsigned long gdcM::SurfaceWriter::NumberOfSurfaces [protected]
```

The documentation for this class was generated from the following file:

- [gdcMSurfaceWriter.h](#)

## 10.299 gdcM::SwapCode Class Reference

[SwapCode](#) representation.

```
#include <gdcMSwapCode.h>
```

### Public Types

- enum [SwapCodeType](#) {  
    [Unknown](#) = 0 ,  
    [LittleEndian](#) = 1234 ,  
    [BigEndian](#) = 4321 ,  
    [BadLittleEndian](#) = 3412 ,  
    [BadBigEndian](#) = 2143 }

### Public Member Functions

- [SwapCode](#) ([SwapCodeType](#) sc=[Unknown](#))
- [operator SwapCode::SwapCodeType](#) () const

### Static Public Member Functions

- static const char \* [GetSwapCodeString](#) ([SwapCode](#) const &sc)

### Static Protected Member Functions

- static int [GetIndex](#) ([SwapCode](#) const &sc)

### Friends

- std::ostream & [operator<<](#) (std::ostream &os, const [SwapCode](#) &sc)



## 10.299.1 Detailed Description

[SwapCode](#) representation.

Examples

[TestByteSwap.cxx](#).

## 10.299.2 Member Enumeration Documentation

### 10.299.2.1 SwapCodeType

```
enum gdcmm::SwapCode::SwapCodeType
```

Enumerator

Unknown	
LittleEndian	
BigEndian	
BadLittleEndian	
BadBigEndian	

## 10.299.3 Constructor & Destructor Documentation

### 10.299.3.1 SwapCode()

```
gdcmm::SwapCode::SwapCode (  
    SwapCodeType sc = Unknown ) [inline]
```

## 10.299.4 Member Function Documentation

### 10.299.4.1 GetIndex()

```
static int gdcmm::SwapCode::GetIndex (  
    SwapCode const & sc ) [static], [protected]
```

#### 10.299.4.2 GetSwapCodeString()

```
static const char* gdcM::SwapCode::GetSwapCodeString (
    SwapCode const & sc ) [static]
```

#### 10.299.4.3 operator SwapCode::SwapCodeType()

```
gdcM::SwapCode::operator SwapCode::SwapCodeType ( ) const [inline]
```

### 10.299.5 Friends And Related Function Documentation

#### 10.299.5.1 operator<<

```
std::ostream& operator<< (
    std::ostream & os,
    const SwapCode & sc ) [friend]
```

The documentation for this class was generated from the following file:

- [gdcMSwapCode.h](#)

## 10.300 gdcM::SwapperDoOp Class Reference

```
#include <gdcMSwapper.h>
```

### Static Public Member Functions

- `template<typename T >`  
static T [Swap](#) (T val)
- `template<typename T >`  
static void [SwapArray](#) (T \*array, size\_t n)

#### 10.300.1 Member Function Documentation

### 10.300.1.1 Swap()

```
template<typename T >
static T gdcm::SwapperDoOp::Swap (
    T val ) [static]
```

### 10.300.1.2 SwapArray()

```
template<typename T >
static void gdcm::SwapperDoOp::SwapArray (
    T * array,
    size_t n ) [inline], [static]
```

The documentation for this class was generated from the following file:

- [gdcmSwapper.h](#)

## 10.301 gdcm::SwapperNoOp Class Reference

```
#include <gdcmSwapper.h>
```

### Static Public Member Functions

- template<typename T >  
static T [Swap](#) (T val)
- template<typename T >  
static void [SwapArray](#) (T \*, size\_t)

### 10.301.1 Detailed Description

#### Examples

[DumpSiemensBase64.cxx](#), [DumpToshibaDTI.cxx](#), and [DumpToshibaDTI2.cxx](#).

### 10.301.2 Member Function Documentation

### 10.301.2.1 Swap()

```
template<typename T >
static T gdcM::SwapperNoOp::Swap (
    T val ) [inline], [static]
```

### 10.301.2.2 SwapArray()

```
template<typename T >
static void gdcM::SwapperNoOp::SwapArray (
    T * ,
    size_t ) [inline], [static]
```

The documentation for this class was generated from the following file:

- [gdcMSwapper.h](#)

## 10.302 gdcM::System Class Reference

Class to do system operation.

```
#include <gdcMSystem.h>
```

### Static Public Member Functions

- static std::wstring [ConvertToUNC](#) (const char \*utf8path)
- static bool [DeleteDirectory](#) (const char \*source)
  - remove a directory named source*
- static size\_t [EncodeBytes](#) (char \*out, const unsigned char \*data, int size)
- static bool [FileExists](#) (const char \*filename)
  - Check whether the specified file exist on the system.*
- static bool [FileIsDirectory](#) (const char \*name)
  - Check whether the file specified is a directory:*
- static bool [FileIsSymlink](#) (const char \*name)
  - Check whether name is a symlink.*
- static size\_t [FileSize](#) (const char \*filename)
- static time\_t [FileTime](#) (const char \*filename)
- static bool [FormatDateTime](#) (char date[22], time\_t t, long milliseconds=0)
- static bool [GetCurrentDateTime](#) (char date[22])
- static const char \* [GetCurrentModuleFileName](#) ()
- static const char \* [GetCurrentProcessFileName](#) ()
- static const char \* [GetCurrentResourcesDirectory](#) ()
- static const char \* [GetCWD](#) ()

- static bool [GetHostName](#) (char hostname[255])
- static const char \* [GetLastError](#) ()  
*Return the last error.*
- static const char \* [GetLocaleCharset](#) ()  
*return locale charmap*
- static const char \* [GetTimezoneOffsetFromUTC](#) ()
- static bool [MakeDirectory](#) (const char \*path)  
*Create a directory name path.*
- static bool [ParseDateTime](#) (time\_t &timep, const char date[22])  
*Parse a date stored as ASCII text into a time\_t structured (discard millisecond if any)*
- static bool [ParseDateTime](#) (time\_t &timep, long &milliseconds, const char date[22])
- static bool [RemoveFile](#) (const char \*source)  
*remove a file named source*
- static int [StrCaseCmp](#) (const char \*s1, const char \*s2)  
*consistent func for C99 spec of strcasecmp/strncasecmp*
- static int [StrNCaseCmp](#) (const char \*s1, const char \*s2, size\_t n)
- static char \* [StrSep](#) (char \*\*stringp, const char \*delim)
- static char \* [StrTokR](#) (char \*ptr, const char \*sep, char \*\*end)  
*strtok\_r*

## Static Protected Member Functions

- static bool [GetPermissions](#) (const char \*file, unsigned short &mode)  
*NOT THREAD SAFE.*
- static bool [SetPermissions](#) (const char \*file, unsigned short mode)

### 10.302.1 Detailed Description

Class to do system operation.

OS independent functionalities

### 10.302.2 Member Function Documentation

#### 10.302.2.1 ConvertToUNC()

```
static std::wstring gdcmm::System::ConvertToUNC (
    const char * utf8path ) [static]
```

When needed convert a PATH into a UNC equivalent. This allow transparent support for path longer than MAX\_PATH. Only on \_MSC\_VER compiler, return empty string otherwise.

### 10.302.2.2 DeleteDirectory()

```
static bool gdcM::System::DeleteDirectory (
    const char * source ) [static]
```

remove a directory named source

### 10.302.2.3 EncodeBytes()

```
static size_t gdcM::System::EncodeBytes (
    char * out,
    const unsigned char * data,
    int size ) [static]
```

Used internally by the [UIDGenerator](#) class to convert a uuid tape to a DICOM [VR:UI](#) type

### 10.302.2.4 FileExists()

```
static bool gdcM::System::FileExists (
    const char * filename ) [static]
```

Check whether the specified file exist on the system.

#### Examples

[DumpVisusChange.cxx](#), [EncapsulateFileInRawData.cxx](#), [MagnifyFile.cxx](#), and [gdcMorthoplanes.cxx](#).

### 10.302.2.5 FileIsDirectory()

```
static bool gdcM::System::FileIsDirectory (
    const char * name ) [static]
```

Check whether the file specified is a directory:

#### Examples

[DumpVisusChange.cxx](#), [gdcMorthoplanes.cxx](#), and [threadgdcM.cxx](#).

### 10.302.2.6 FileIsSymlink()

```
static bool gdcM::System::FileIsSymlink (
    const char * name ) [static]
```

Check whether name is a symlink.

### 10.302.2.7 FileSize()

```
static size_t gdcM::System::FileSize (
    const char * filename ) [static]
```

Return the filesize. 0 if file does not exist.

#### Warning

you need to use FileExists to differentiate between empty file and missing file.

for very large size file and on system where size\_t is not appropriate to store off\_t value the function will return 0.

#### Examples

[CheckBigEndianBug.cxx](#), [CreateARGBImage.cxx](#), [CreateCMYKImage.cxx](#), [EncapsulateFileInRawData.cxx](#), and [SimpleScanner.cxx](#).

### 10.302.2.8 FileTime()

```
static time_t gdcM::System::FileTime (
    const char * filename ) [static]
```

Return the time of last modification of file 0 if the file does not exist

### 10.302.2.9 FormatDateTime()

```
static bool gdcM::System::FormatDateTime (
    char date[22],
    time_t t,
    long milliseconds = 0 ) [static]
```

format as ASCII text a time\_t with milliseconds See [VR::DT](#) from DICOM PS 3.5 milliseconds is in the range [0, 999999]

### 10.302.2.10 GetCurrentDateTime()

```
static bool gdcm::System::GetCurrentDateTime (
    char date[22] ) [static]
```

Return the current data time, and format it as ASCII text. This is simply a call to `gettimeofday + FormatDateTime`, since WIN32 do not have an implementation for `gettimeofday`, this is more portable. The call `time(0)` is not precise for our resolution

#### Examples

[TemplateEmptyImage.cxx](#).

### 10.302.2.11 GetCurrentModuleFileName()

```
static const char* gdcm::System::GetCurrentModuleFileName ( ) [static]
```

Return the directory the current module is located: NOT THREAD SAFE

### 10.302.2.12 GetCurrentProcessFileName()

```
static const char* gdcm::System::GetCurrentProcessFileName ( ) [static]
```

Return the directory the current process (executable) is located: NOT THREAD SAFE

### 10.302.2.13 GetCurrentResourcesDirectory()

```
static const char* gdcm::System::GetCurrentResourcesDirectory ( ) [static]
```

On some system (Apple) return the path to the current bundled 'Resources' directory NOT THREAD SAFE

### 10.302.2.14 GetCWD()

```
static const char* gdcm::System::GetCWD ( ) [static]
```

Return current working directory Warning: if current working path is too long (>2048 bytes) the call will fail and call will return NULL NOT THREAD SAFE

### 10.302.2.15 GetHostName()

```
static bool gdcm::System::GetHostName (
    char hostname[255] ) [static]
```

Retrieve the hostname, only the first 255 byte are copied. This may come handy to specify the Station Name



### 10.302.2.16 GetLastSystemError()

```
static const char* gdcmm::System::GetLastSystemError ( ) [static]
```

Return the last error.

### 10.302.2.17 GetLocaleCharset()

```
static const char* gdcmm::System::GetLocaleCharset ( ) [static]
```

return locale charmap

### 10.302.2.18 GetPermissions()

```
static bool gdcmm::System::GetPermissions (
    const char * file,
    unsigned short & mode ) [static], [protected]
```

NOT THREAD SAFE.

### 10.302.2.19 GetTimezoneOffsetFromUTC()

```
static const char* gdcmm::System::GetTimezoneOffsetFromUTC ( ) [static]
```

Return the value for Timezone Offset From UTC as string.

#### Warning

not thread safe

### 10.302.2.20 MakeDirectory()

```
static bool gdcmm::System::MakeDirectory (
    const char * path ) [static]
```

Create a directory name path.

**10.302.2.21 ParseDateTime()** [1/2]

```
static bool gdcM::System::ParseDateTime (
    time_t & timep,
    const char date[22] ) [static]
```

Parse a date stored as ASCII text into a `time_t` structured (discard millisecond if any)

**10.302.2.22 ParseDateTime()** [2/2]

```
static bool gdcM::System::ParseDateTime (
    time_t & timep,
    long & milliseconds,
    const char date[22] ) [static]
```

Parse a date stored as ASCII text into a `time_t` structured and millisecond

See also

[FormatDateTime](#)

**10.302.2.23 RemoveFile()**

```
static bool gdcM::System::RemoveFile (
    const char * source ) [static]
```

remove a file named `source`

**10.302.2.24 SetPermissions()**

```
static bool gdcM::System::SetPermissions (
    const char * file,
    unsigned short mode ) [static], [protected]
```

### 10.302.2.25 StrCaseCmp()

```
static int gdcm::System::StrCaseCmp (
    const char * s1,
    const char * s2 ) [static]
```

consistent func for C99 spec of strcasecmp/strncasecmp

### 10.302.2.26 StrNCaseCmp()

```
static int gdcm::System::StrNCaseCmp (
    const char * s1,
    const char * s2,
    size_t n ) [static]
```

#### Precondition

n != 0

### 10.302.2.27 StrSep()

```
static char* gdcm::System::StrSep (
    char ** stringp,
    const char * delim ) [static]
```

strsep param stringp is passed by pointer, it may be modified, you'll need to make a copy, in case you want to free the memory pointed at

### 10.302.2.28 StrTokR()

```
static char* gdcm::System::StrTokR (
    char * ptr,
    const char * sep,
    char ** end ) [static]
```

strtok\_r

The documentation for this class was generated from the following file:

- [gdcmSystem.h](#)

## 10.303 gdcm::Table Class Reference

Table.

```
#include <gdcmTable.h>
```

Collaboration diagram for gdcm::Table:

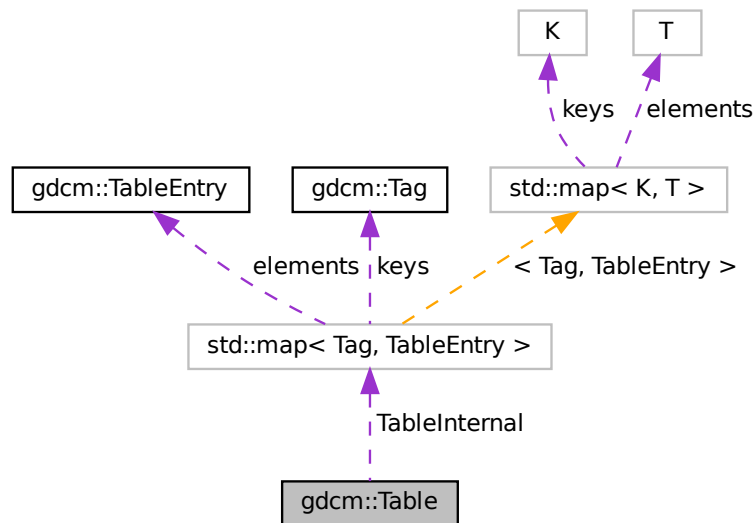

### Public Types

- typedef `std::map< Tag, TableEntry >` `MapTableEntry`

### Public Member Functions

- `Table` ()=default
- `Table` (const `Table` &\_val)=delete
- `~Table` ()=default
- const `TableEntry` & `GetTableEntry` (const `Tag` &tag) const
- void `InsertEntry` (`Tag` const &tag, `TableEntry` const &te)
- `Table` & `operator=` (const `Table` &\_val)=delete

### Public Attributes

- `MapTableEntry` `TableInternal`

## Friends

- `std::ostream & operator<<` (`std::ostream &_os`, `const Table &_val`)

### 10.303.1 Detailed Description

[Table](#).

### 10.303.2 Member Typedef Documentation

#### 10.303.2.1 MapTableEntry

```
typedef std::map<Tag, TableEntry> gdcM::Table::MapTableEntry
```

### 10.303.3 Constructor & Destructor Documentation

#### 10.303.3.1 Table() [1/2]

```
gdcM::Table::Table ( ) [default]
```

#### 10.303.3.2 ~Table()

```
gdcM::Table::~~Table ( ) [default]
```

#### 10.303.3.3 Table() [2/2]

```
gdcM::Table::Table (
    const Table & _val ) [delete]
```

### 10.303.4 Member Function Documentation

#### 10.303.4.1 GetTableEntry()

```
const TableEntry& gdcM::Table::GetTableEntry (
    const Tag & tag ) const [inline]
```

References TableInternal.

#### 10.303.4.2 InsertEntry()

```
void gdcM::Table::InsertEntry (
    Tag const & tag,
    TableEntry const & te ) [inline]
```

References TableInternal.

#### 10.303.4.3 operator=()

```
Table& gdcM::Table::operator= (
    const Table & _val ) [delete]
```

### 10.303.5 Friends And Related Function Documentation

#### 10.303.5.1 operator<<

```
std::ostream& operator<< (
    std::ostream & _os,
    const Table & _val ) [friend]
```

### 10.303.6 Member Data Documentation

#### 10.303.6.1 TableInternal

`MapTableEntry` gdcM::Table::TableInternal

Referenced by GetTableEntry(), and InsertEntry().

The documentation for this class was generated from the following file:

- [gdcMTable.h](#)

## 10.304 gdcm::TableEntry Class Reference

[TableEntry](#).

```
#include <gdcmTableEntry.h>
```

### Public Member Functions

- [TableEntry](#) (const char \*attribute=nullptr, [Type](#) const &type=[Type](#)(), const char \*des=nullptr)
- [~TableEntry](#) ()=default

### 10.304.1 Detailed Description

[TableEntry](#).

### 10.304.2 Constructor & Destructor Documentation

#### 10.304.2.1 TableEntry()

```
gdcm::TableEntry::TableEntry (  
    const char * attribute = nullptr,  
    Type const & type = Type(),  
    const char * des = nullptr ) [inline]
```

#### 10.304.2.2 ~TableEntry()

```
gdcm::TableEntry::~~TableEntry ( ) [default]
```

The documentation for this class was generated from the following file:

- [gdcmTableEntry.h](#)

## 10.305 gdcM::TableReader Class Reference

Class for representing a [TableReader](#).

```
#include <gdcMTableReader.h>
```

Inheritance diagram for gdcM::TableReader:

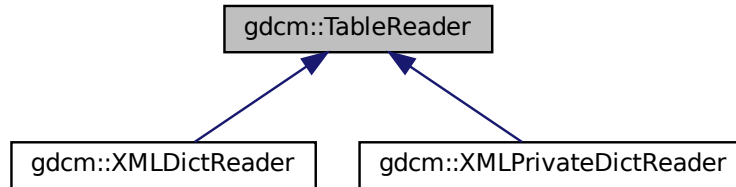

### Public Member Functions

- [TableReader](#) (Defs &defs)
- virtual [~TableReader](#) ()=default
- virtual void [CharacterDataHandler](#) (const char \*data, int length)
- virtual void [EndElement](#) (const char \*name)
- const Defs & [GetDefs](#) () const
- const char \* [GetFilename](#) ()
- void [HandleIOD](#) (const char \*\*atts)
- void [HandleIODEntry](#) (const char \*\*atts)
- void [HandleMacro](#) (const char \*\*atts)
- void [HandleMacroEntry](#) (const char \*\*atts)
- void [HandleMacroEntryDescription](#) (const char \*\*atts)
- void [HandleModule](#) (const char \*\*atts)
- void [HandleModuleEntry](#) (const char \*\*atts)
- void [HandleModuleEntryDescription](#) (const char \*\*atts)
- void [HandleModuleInclude](#) (const char \*\*atts)
- int [Read](#) ()
- void [SetFilename](#) (const char \*filename)
- virtual void [StartElement](#) (const char \*name, const char \*\*atts)

### 10.305.1 Detailed Description

Class for representing a [TableReader](#).

#### Note

This class is an empty shell meant to be derived



## 10.305.2 Constructor & Destructor Documentation

### 10.305.2.1 TableReader()

```
gdcm::TableReader::TableReader (  
    Defs & defs ) [inline]
```

### 10.305.2.2 ~TableReader()

```
virtual gdcm::TableReader::~~TableReader ( ) [virtual], [default]
```

## 10.305.3 Member Function Documentation

### 10.305.3.1 CharacterDataHandler()

```
virtual void gdcm::TableReader::CharacterDataHandler (  
    const char * data,  
    int length ) [virtual]
```

Reimplemented in [gdcm::XMLPrivateDictReader](#), and [gdcm::XMLDictReader](#).

### 10.305.3.2 EndElement()

```
virtual void gdcm::TableReader::EndElement (  
    const char * name ) [virtual]
```

Reimplemented in [gdcm::XMLPrivateDictReader](#), and [gdcm::XMLDictReader](#).

### 10.305.3.3 GetDefs()

```
const Defs& gdcm::TableReader::GetDefs ( ) const [inline]
```

#### 10.305.3.4 GetFilename()

```
const char* gdcM::TableReader::GetFilename ( ) [inline]
```

#### 10.305.3.5 HandleIOD()

```
void gdcM::TableReader::HandleIOD (
    const char ** atts )
```

#### 10.305.3.6 HandleIODEntry()

```
void gdcM::TableReader::HandleIODEntry (
    const char ** atts )
```

#### 10.305.3.7 HandleMacro()

```
void gdcM::TableReader::HandleMacro (
    const char ** atts )
```

#### 10.305.3.8 HandleMacroEntry()

```
void gdcM::TableReader::HandleMacroEntry (
    const char ** atts )
```

#### 10.305.3.9 HandleMacroEntryDescription()

```
void gdcM::TableReader::HandleMacroEntryDescription (
    const char ** atts )
```

### 10.305.3.10 HandleModule()

```
void gdcM::TableReader::HandleModule (
    const char ** atts )
```

### 10.305.3.11 HandleModuleEntry()

```
void gdcM::TableReader::HandleModuleEntry (
    const char ** atts )
```

### 10.305.3.12 HandleModuleEntryDescription()

```
void gdcM::TableReader::HandleModuleEntryDescription (
    const char ** atts )
```

### 10.305.3.13 HandleModuleInclude()

```
void gdcM::TableReader::HandleModuleInclude (
    const char ** atts )
```

### 10.305.3.14 Read()

```
int gdcM::TableReader::Read ( )
```

### 10.305.3.15 SetFilename()

```
void gdcM::TableReader::SetFilename (
    const char * filename ) [inline]
```

### 10.305.3.16 StartElement()

```
virtual void gdcM::TableReader::StartElement (
    const char * name,
    const char ** atts ) [virtual]
```

Reimplemented in [gdcM::XMLPrivateDictReader](#), and [gdcM::XMLDictReader](#).

The documentation for this class was generated from the following file:

- [gdcMTableReader.h](#)

## 10.306 gdcM::network::TableRow Class Reference

```
#include <gdcMULTransitionTable.h>
```

Collaboration diagram for gdcM::network::TableRow:

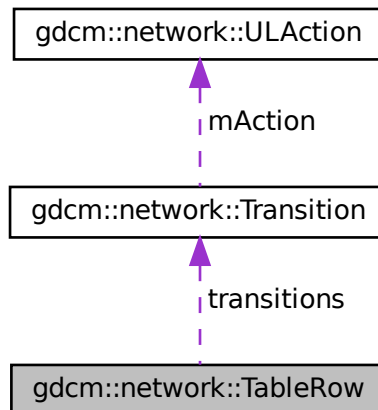

### Public Member Functions

- [TableRow \(\)](#)
- [~TableRow \(\)](#)

### Public Attributes

- [Transition \\* transitions](#) [cMaxStateID]

## 10.306.1 Constructor & Destructor Documentation

### 10.306.1.1 TableRow()

```
gdcM::network::TableRow::TableRow ( ) [inline]
```

References `gdcM::network::cMaxStateID`, and `transitions`.

### 10.306.1.2 ~TableRow()

```
gdcM::network::TableRow::~~TableRow ( ) [inline]
```

References `gdcM::network::cMaxStateID`, and `transitions`.

## 10.306.2 Member Data Documentation

### 10.306.2.1 transitions

```
Transition* gdcM::network::TableRow::transitions[cMaxStateID]
```

Referenced by `TableRow()`, and `~TableRow()`.

The documentation for this class was generated from the following file:

- [gdcMULTransitionTable.h](#)

## 10.307 gdcM::Tag Class Reference

Class to represent a DICOM Data [Element](#) ([Attribute](#)) [Tag](#) ([Group](#), [Element](#)).

```
#include <gdcMTag.h>
```

Inheritance diagram for `gdcM::Tag`:

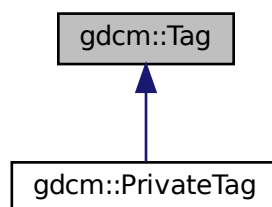

## Public Member Functions

- [Tag](#) (const [Tag](#) &\_val)
- [Tag](#) (uint16\_t group, uint16\_t element)  
*Constructor with 2\*uint16\_t.*
- [Tag](#) (uint32\_t tag=0)  
*Constructor with 1\*uint32\_t Prefer the ctor that takes two uint16\_t.*
- uint16\_t [GetElement](#) () const  
*Returns the 'Element number' of the given Tag.*
- uint32\_t [GetElementTag](#) () const  
*Returns the full tag value of the given Tag.*
- uint16\_t [GetGroup](#) () const  
*Returns the 'Group number' of the given Tag.*
- uint32\_t [GetLength](#) () const  
*return the length of tag (read: size on disk)*
- [Tag](#) [GetPrivateCreator](#) () const  
*Return the Private Creator Data Element tag of a private data element.*
- bool [IsGroupLength](#) () const  
*return whether the tag correspond to a group length tag:*
- bool [IsGroupXX](#) (const [Tag](#) &t) const  
*e.g 6002,3000 belong to groupXX: 6000,3000*
- bool [IsIllegal](#) () const  
*return if the tag is considered to be an illegal tag*
- bool [IsPrivate](#) () const
- bool [IsPrivateCreator](#) () const
- bool [IsPublic](#) () const
- bool [operator!=](#) (const [Tag](#) &\_val) const
- bool [operator<](#) (const [Tag](#) &\_val) const
- bool [operator<=](#) (const [Tag](#) &t2) const
- [Tag](#) & [operator=](#) (const [Tag](#) &\_val)
- bool [operator==](#) (const [Tag](#) &\_val) const
- uint16\_t & [operator\[\]](#) (const unsigned int &\_id)  
*Returns the Group or Element of the given Tag, depending on id (0/1)*
- const uint16\_t & [operator\[\]](#) (const unsigned int &\_id) const  
*Returns the Group or Element of the given Tag, depending on id (0/1)*
- std::string [PrintAsContinuousString](#) () const
- std::string [PrintAsContinuousUpperCaseString](#) () const  
*Same as PrintAsContinuousString, but hexadecimal [a-f] are printed using upper case.*
- std::string [PrintAsPipeSeparatedString](#) () const
- template<typename TSwap >  
std::istream & [Read](#) (std::istream &is)  
*Read a tag from binary representation.*
- bool [ReadFromCommaSeparatedString](#) (const char \*str)
- bool [ReadFromContinuousString](#) (const char \*str)
- bool [ReadFromPipeSeparatedString](#) (const char \*str)
- void [SetElement](#) (uint16\_t element)  
*Sets the 'Element number' of the given Tag.*
- void [SetElementTag](#) (uint16\_t group, uint16\_t element)

- Sets the 'Group number' & 'Element number' of the given [Tag](#).*
- void [SetElementTag](#) (uint32\_t tag)
  - Sets the full tag value of the given [Tag](#).*
- void [SetGroup](#) (uint16\_t group)
  - Sets the 'Group number' of the given [Tag](#).*
- void [SetPrivateCreator](#) ([Tag](#) const &t)
  - Set private creator:*
- template<typename TSwap >
  - const std::ostream & [Write](#) (std::ostream &os) const

*Write a tag in binary rep.*

## Friends

- std::ostream & [operator<<](#) (std::ostream &\_os, const [Tag](#) &\_val)
- std::istream & [operator>>](#) (std::istream &\_is, [Tag](#) &\_val)

### 10.307.1 Detailed Description

Class to represent a DICOM Data [Element](#) ([Attribute](#) [Tag](#) (Group, [Element](#))).

Basically an uint32\_t which can also be expressed as two uint16\_t (group and element)

#### Note

DATA ELEMENT TAG: A unique identifier for a Data [Element](#) composed of an ordered pair of numbers (a Group Number followed by an [Element](#) Number). GROUP NUMBER: The first number in the ordered pair of numbers that makes up a Data [Element Tag](#). ELEMENT NUMBER: The second number in the ordered pair of numbers that makes up a Data [Element Tag](#).

#### Examples

[ChangeSequenceUltrasound.cxx](#), [ClinicalTrialAnnotate.cxx](#), [CreateARGBImage.cxx](#), [CreateCMYKImage.cxx](#), [CreateFakeRTDOSE.cxx](#), [CreateJPIPDataSet.cxx](#), [DeriveSeries.cxx](#), [DumpToSQLITE3.cxx](#), [DuplicatePCDE.cxx](#), [EncapsulateFileInRawData.cxx](#), [ExtractEncryptedContent.cxx](#), [Extracting\\_All\\_Resolution.cxx](#), [Fake\\_Image\\_Using\\_Stream\\_Image\\_V](#), [FixBrokenJ2K.cxx](#), [FixJAIBugJPEGLS.cxx](#), [GenAllVR.cxx](#), [GenFakelIdentifyFile.cxx](#), [GenFakelImage.cxx](#), [GenLongSeqs.cxx](#), [GenSeqs.cxx](#), [GetJPEGSamplePrecision.cxx](#), [GetSequenceUltrasound.cxx](#), [LargeVRDSExplicit.cxx](#), [MakeTemplate.cxx](#), [MergeTwoFiles.cxx](#), [PatchFile.cxx](#), [PublicDict.cxx](#), [ReadAndDumpDICOMDIR.cxx](#), [ReadAndDumpDICOMDIR2](#), [ReadExplicitLengthSQIVR.cxx](#), [SimpleScanner.cxx](#), [SortImage.cxx](#), [StreamImageReaderTest.cxx](#), [VolumeSorter.cxx](#), [gdcmrtionplan.cxx](#), [gdcmrtplan.cxx](#), [iU22tomultisc.cxx](#), [pmsct\\_rgb1.cxx](#), and [rle2img.cxx](#).

### 10.307.2 Constructor & Destructor Documentation

### 10.307.2.1 Tag() [1/3]

```
gdcM::Tag::Tag (
    uint16_t group,
    uint16_t element ) [inline]
```

Constructor with 2\*uint16\_t.

### 10.307.2.2 Tag() [2/3]

```
gdcM::Tag::Tag (
    uint32_t tag = 0 ) [inline]
```

Constructor with 1\*uint32\_t Prefer the ctor that takes two uint16\_t.

### 10.307.2.3 Tag() [3/3]

```
gdcM::Tag::Tag (
    const Tag & _val ) [inline]
```

References tag.

## 10.307.3 Member Function Documentation

### 10.307.3.1 GetElement()

```
uint16_t gdcM::Tag::GetElement ( ) const [inline]
```

Returns the 'Element number' of the given [Tag](#).

#### Examples

[DuplicatePCDE.cxx](#), and [PublicDict.cxx](#).

Referenced by [gdcM::PrivateTag::PrivateTag\(\)](#), [gdcM::DataSet::ComputeGroupLength\(\)](#), [IsGroupXX\(\)](#), [gdcM::PrivateDict::PrintXML\(\)](#), [gdcM::SequenceOfFragments::ReadValue\(\)](#), and [SetPrivateCreator\(\)](#).



### 10.307.3.2 GetElementTag()

```
uint32_t gdcm::Tag::GetElementTag ( ) const [inline]
```

Returns the full tag value of the given [Tag](#).

### 10.307.3.3 GetGroup()

```
uint16_t gdcm::Tag::GetGroup ( ) const [inline]
```

Returns the 'Group number' of the given [Tag](#).

#### Examples

[DuplicatePCDE.cxx](#), and [GenAllVR.cxx](#).

Referenced by [gdcm::DataSet::ComputeGroupLength\(\)](#), [gdcm::DataSet::Insert\(\)](#), [gdcm::FileMetaInformation::Insert\(\)](#), [gdcm::CommandDataSet::Insert\(\)](#), [IsGroupXX\(\)](#), [gdcm::PrivateDict::PrintXML\(\)](#), [gdcm::SequenceOfFragments::ReadValue\(\)](#), and [SetPrivateCreator\(\)](#).

### 10.307.3.4 GetLength()

```
uint32_t gdcm::Tag::GetLength ( ) const [inline]
```

return the length of tag (read: size on disk)

### 10.307.3.5 GetPrivateCreator()

```
Tag gdcm::Tag::GetPrivateCreator ( ) const [inline]
```

Return the Private Creator Data [Element](#) tag of a private data element.

References [SetElement\(\)](#).

### 10.307.3.6 IsGroupLength()

```
bool gdcm::Tag::IsGroupLength ( ) const [inline]
```

return whether the tag correspond to a group length tag:

### 10.307.3.7 IsGroupXX()

```
bool gdcM::Tag::IsGroupXX (
    const Tag & t ) const [inline]
```

e.g 6002,3000 belong to groupXX: 6000,3000

References GetElement(), GetGroup(), and IsPrivate().

### 10.307.3.8 IsIllegal()

```
bool gdcM::Tag::IsIllegal ( ) const [inline]
```

return if the tag is considered to be an illegal tag

### 10.307.3.9 IsPrivate()

```
bool gdcM::Tag::IsPrivate ( ) const [inline]
```

PRIVATE DATA ELEMENT: Additional Data [Element](#), defined by an implementor, to communicate information that is not contained in Standard Data Elements. Private Data elements have odd Group Numbers.

#### Examples

[DuplicatePCDE.cxx](#).

Referenced by IsGroupXX(), and SetPrivateCreator().

### 10.307.3.10 IsPrivateCreator()

```
bool gdcM::Tag::IsPrivateCreator ( ) const [inline]
```

Returns if tag is a Private Creator (xxxx,00yy), where xxxx is odd number and yy in [0x10,0xFF]

#### Examples

[DuplicatePCDE.cxx](#).

### 10.307.3.11 IsPublic()

```
bool gdcM::Tag::IsPublic ( ) const [inline]
```

STANDARD DATA ELEMENT: A Data [Element](#) defined in the DICOM Standard, and therefore listed in the DICOM Data [Element](#) Dictionary in PS 3.6. Is the [Tag](#) from the Public dict...well the implementation is buggy it does not prove the element is indeed in the dict...

### 10.307.3.12 operator!=(())

```
bool gdcM::Tag::operator!=(  
    const Tag & _val ) const [inline]
```

References tag.

### 10.307.3.13 operator<()

```
bool gdcM::Tag::operator< (  
    const Tag & _val ) const [inline]
```

DICOM Standard expects the Data [Element](#) to be sorted by Tags All other comparison can be constructed from this one and operator ==

References tag, and tags.

### 10.307.3.14 operator<=()

```
bool gdcM::Tag::operator<= (  
    const Tag & t2 ) const [inline]
```

### 10.307.3.15 operator=()

```
Tag& gdcM::Tag::operator= (  
    const Tag & _val ) [inline]
```

References tag.

**10.307.3.16 operator==()**

```
bool gdcM::Tag::operator== (
    const Tag & _val ) const [inline]
```

References tag.

**10.307.3.17 operator[]() [1/2]**

```
uint16_t& gdcM::Tag::operator[] (
    const unsigned int & _id ) [inline]
```

Returns the Group or [Element](#) of the given [Tag](#), depending on id (0/1)

**10.307.3.18 operator[]() [2/2]**

```
const uint16_t& gdcM::Tag::operator[] (
    const unsigned int & _id ) const [inline]
```

Returns the Group or [Element](#) of the given [Tag](#), depending on id (0/1)

**10.307.3.19 PrintAsContinuousString()**

```
std::string gdcM::Tag::PrintAsContinuousString ( ) const
```

Print tag value with no separating comma: eg. tag = "12345678" It comes in useful when reading tag values from XML file(in NativeDICOMModel)

**10.307.3.20 PrintAsContinuousUpperCaseString()**

```
std::string gdcM::Tag::PrintAsContinuousUpperCaseString ( ) const
```

Same as PrintAsContinuousString, but hexadecimal [a-f] are printed using upper case.

### 10.307.3.21 PrintAsPipeSeparatedString()

```
std::string gdcm::Tag::PrintAsPipeSeparatedString ( ) const
```

Print as a pipe separated string (GDCM 1.x compat only). Do not use in newer code

See also

[ReadFromPipeSeparatedString](#)

### 10.307.3.22 Read()

```
template<typename TSwap >
std::istream& gdcm::Tag::Read (
    std::istream & is ) [inline]
```

Read a tag from binary representation.

### 10.307.3.23 ReadFromCommaSeparatedString()

```
bool gdcm::Tag::ReadFromCommaSeparatedString (
    const char * str )
```

Read from a comma separated string. This is a highly user oriented function, the string should be formatted as ← : 1234,5678 to specify the tag (0x1234,0x5678) The notation comes from the DICOM standard, and is handy to use from a command line program

### 10.307.3.24 ReadFromContinuousString()

```
bool gdcm::Tag::ReadFromContinuousString (
    const char * str )
```

Read From XML formatted tag value eg. tag = "12345678" It comes in useful when reading tag values from XML file(in NativeDICOMModel)

### 10.307.3.25 ReadFromPipeSeparatedString()

```
bool gdcm::Tag::ReadFromPipeSeparatedString (
    const char * str )
```

Read from a pipe separated string (GDCM 1.x compat only). Do not use in newer code

See also

[ReadFromCommaSeparatedString](#)

### 10.307.3.26 SetElement()

```
void gdcM::Tag::SetElement (
    uint16_t element ) [inline]
```

Sets the '[Element](#) number' of the given [Tag](#).

#### Examples

[DuplicatePCDE.cxx](#), and [PublicDict.cxx](#).

Referenced by [GetPrivateCreator\(\)](#).

### 10.307.3.27 SetElementTag() [1/2]

```
void gdcM::Tag::SetElementTag (
    uint16_t group,
    uint16_t element ) [inline]
```

Sets the 'Group number' & '[Element](#) number' of the given [Tag](#).

### 10.307.3.28 SetElementTag() [2/2]

```
void gdcM::Tag::SetElementTag (
    uint32_t tag ) [inline]
```

Sets the full tag value of the given [Tag](#).

### 10.307.3.29 SetGroup()

```
void gdcM::Tag::SetGroup (
    uint16_t group ) [inline]
```

Sets the 'Group number' of the given [Tag](#).

### 10.307.3.30 SetPrivateCreator()

```
void gdcM::Tag::SetPrivateCreator (
    Tag const & t ) [inline]
```

Set private creator:

#### Examples

[DuplicatePCDE.cxx](#).

References [GetElement\(\)](#), [GetGroup\(\)](#), and [IsPrivate\(\)](#).

### 10.307.3.31 Write()

```
template<typename TSwap >
const std::ostream& gdcM::Tag::Write (
    std::ostream & os ) const [inline]
```

Write a tag in binary rep.

Referenced by [gdcM::Item::Write\(\)](#), [gdcM::SequenceOfFragments::Write\(\)](#), and [gdcM::SequenceOfItems::Write\(\)](#).

## 10.307.4 Friends And Related Function Documentation

### 10.307.4.1 operator<<

```
std::ostream& operator<< (
    std::ostream & _os,
    const Tag & _val ) [friend]
```

### 10.307.4.2 operator>>

```
std::istream& operator>> (
    std::istream & _is,
    Tag & _val ) [friend]
```

## 10.307.5 Member Data Documentation

### 10.307.5.1 bytes

```
char gdcM::Tag::bytes[4]
```

### 10.307.5.2 tag

```
uint32_t gdcM::Tag::tag
```

Referenced by Tag(), operator!(), operator<(), operator=(), and operator==().

### 10.307.5.3 tags

```
uint16_t gdcM::Tag::tags[2]
```

Referenced by operator<().

The documentation for this class was generated from the following file:

- [gdcMTag.h](#)

## 10.308 gdcM::TagPath Class Reference

class to handle a path of tag.

```
#include <gdcMTagPath.h>
```

### Public Member Functions

- [TagPath](#) ()
- [~TagPath](#) ()
- bool [ConstructFromString](#) (const char \*path)
- bool [ConstructFromTagList](#) (Tag const \*l, unsigned int n)  
*Construct from a list of tags.*
- void [Print](#) (std::ostream &) const
- bool [Push](#) (Tag const &t)
- bool [Push](#) (unsigned int itemnum)



## Static Public Member Functions

- static bool [IsValid](#) (const char \*path)  
*Return if path is valid or not.*

### 10.308.1 Detailed Description

class to handle a path of tag.

Any Resemblance to Existing XPath is Purely Coincidental [ftp://medical.nema.org/medical/dicom/supps/sup118←\\_pc.pdf](ftp://medical.nema.org/medical/dicom/supps/sup118←_pc.pdf)

### 10.308.2 Constructor & Destructor Documentation

#### 10.308.2.1 TagPath()

```
gdcm::TagPath::TagPath ( )
```

#### 10.308.2.2 ~TagPath()

```
gdcm::TagPath::~~TagPath ( )
```

### 10.308.3 Member Function Documentation

#### 10.308.3.1 ConstructFromString()

```
bool gdcm::TagPath::ConstructFromString (
    const char * path )
```

"/0018,0018/"... No space allowed, comma is use to separate tag group from tag element and slash is used to separate tag return false if invalid

### 10.308.3.2 ConstructFromTagList()

```
bool gdcM::TagPath::ConstructFromTagList (
    Tag const * l,
    unsigned int n )
```

Construct from a list of tags.

### 10.308.3.3 IsValid()

```
static bool gdcM::TagPath::IsValid (
    const char * path ) [static]
```

Return if path is valid or not.

### 10.308.3.4 Print()

```
void gdcM::TagPath::Print (
    std::ostream & ) const
```

### 10.308.3.5 Push() [1/2]

```
bool gdcM::TagPath::Push (
    Tag const & t )
```

### 10.308.3.6 Push() [2/2]

```
bool gdcM::TagPath::Push (
    unsigned int itemnum )
```

The documentation for this class was generated from the following file:

- [gdcMTagPath.h](#)

## 10.309 gdcm::Testing Class Reference

class for testing

```
#include <gdcmTesting.h>
```

### Public Types

- typedef const char \*const (\* [MD5DataImagesType](#))[2]
- typedef const char \*const (\* [MediaStorageDataFilesType](#))[2]  
*return the table that map the media storage (as string) of a filename (gdcmData)*

### Public Member Functions

- [Testing](#) ()=default
- [~Testing](#) ()=default
- void [Print](#) (std::ostream &os=std::cout)  
*Print.*

### Static Public Member Functions

- static bool [ComputeFileMD5](#) (const char \*filename, char digest\_str[33])
- static bool [ComputeMD5](#) (const char \*buffer, size\_t buf\_len, char digest\_str[33])
- static const char \* [GetDataExtraRoot](#) ()  
*Return the GDCM DATA EXTRA ROOT.*
- static const char \* [GetDataRoot](#) ()  
*Return the GDCM DATA ROOT.*
- static const char \* [GetFileName](#) (unsigned int file)
- static const char \*const \* [GetFileNames](#) ()  
*return the table of fullpath to gdcmData DICOM files:*
- static int [GetLossyFlagFromFile](#) (const char \*filepath)
- static const char \*const \* [GetMD5DataImage](#) (unsigned int file)
- static [MD5DataImagesType](#) [GetMD5DataImages](#) ()
- static const char \* [GetMD5FromBrokenFile](#) (const char \*filepath)
- static const char \* [GetMD5FromFile](#) (const char \*filepath)
- static const char \*const \* [GetMediaStorageDataFile](#) (unsigned int file)
- static [MediaStorageDataFilesType](#) [GetMediaStorageDataFiles](#) ()
- static const char \* [GetMediaStorageFromFile](#) (const char \*filepath)
- static unsigned int [GetNumberOfFileNames](#) ()
- static unsigned int [GetNumberOfMD5DataImages](#) ()
- static unsigned int [GetNumberOfMediaStorageDataFiles](#) ()
- static const char \* [GetPixelSpacingDataRoot](#) ()  
*Return the GDCM PIXEL SPACING DATA ROOT (See David Clunie website for dataset)*
- static std::streamoff [GetSelectedPrivateGroupOffsetFromFile](#) (const char \*filepath)
- static std::streamoff [GetSelectedTagsOffsetFromFile](#) (const char \*filepath)
- static const char \* [GetSourceDirectory](#) ()

- static std::streamoff [GetStreamOffsetFromFile](#) (const char \*filepath)
- static const char \* [GetTempDirectory](#) (const char \*subdir=nullptr)
- static const wchar\_t \* [GetTempDirectoryW](#) (const wchar\_t \*subdir=nullptr)  
*NOT THREAD SAFE.*
- static const char \* [GetTempFilename](#) (const char \*filename, const char \*subdir=nullptr)  
*NOT THREAD SAFE.*
- static const wchar\_t \* [GetTempFilenameW](#) (const wchar\_t \*filename, const wchar\_t \*subdir=nullptr)  
*NOT THREAD SAFE.*

### 10.309.1 Detailed Description

class for testing

this class is used for the nightly regression system for GDCM It makes heavily use of md5 computation

See also

[gdcM::MD5](#) class for md5 computation

### 10.309.2 Member Typedef Documentation

#### 10.309.2.1 MD5DataImagesType

```
typedef const char* const(* gdcM::Testing::MD5DataImagesType) [2]
```

return the table that map the md5 (as in md5sum) of the Pixel Data associated to a filename

#### 10.309.2.2 MediaStorageDataFilesType

```
typedef const char* const(* gdcM::Testing::MediaStorageDataFilesType) [2]
```

return the table that map the media storage (as string) of a filename (gdcMData)

### 10.309.3 Constructor & Destructor Documentation

#### 10.309.3.1 Testing()

```
gdcM::Testing::Testing ( ) [default]
```

### 10.309.3.2 ~Testing()

```
gdcmm::Testing::~~Testing ( ) [default]
```

## 10.309.4 Member Function Documentation

### 10.309.4.1 ComputeFileMD5()

```
static bool gdcmm::Testing::ComputeFileMD5 (
    const char * filename,
    char digest_str[33] ) [static]
```

#### Examples

[MetalImageMD5Activiz.cs](#).

### 10.309.4.2 ComputeMD5()

```
static bool gdcmm::Testing::ComputeMD5 (
    const char * buffer,
    size_t buf_len,
    char digest_str[33] ) [static]
```

**MD5** stuff `digest_str` needs to be at least : `strlen = [2*16+1]`; string will be `\0` padded. (md5 are 32 bytes long) **Testing** is not meant to be shipped with an installed GDCM release, always prefer the [gdcmm::MD5](#) API when doing md5 computation.

### 10.309.4.3 GetDataExtraRoot()

```
static const char* gdcmm::Testing::GetDataExtraRoot ( ) [static]
```

Return the GDCM DATA EXTRA ROOT.

#### Examples

[DiscriminateVolume.cxx](#), [VolumeSorter.cxx](#), and [reslicesphere.cxx](#).

#### 10.309.4.4 GetDataRoot()

```
static const char* gdcM::Testing::GetDataRoot ( ) [static]
```

Return the GDCM DATA ROOT.

##### Examples

[Convert16BitsTo8Bits.cxx](#), [ConvertMultiFrameToSingleFrame.cxx](#), [ConvertRGBToLuminance.cxx](#), and [MagnifyFile.cxx](#).

#### 10.309.4.5 GetFileName()

```
static const char* gdcM::Testing::GetFileName (
    unsigned int file ) [static]
```

##### Examples

[MetalImageMD5Activiz.cs](#).

#### 10.309.4.6 GetFileNames()

```
static const char* const* gdcM::Testing::GetFileNames ( ) [static]
```

return the table of fullpath to gdcMData DICOM files:

##### Examples

[TestReader.cxx](#).

#### 10.309.4.7 GetLossyFlagFromFile()

```
static int gdcM::Testing::GetLossyFlagFromFile (
    const char * filepath ) [static]
```

Return the lossy flag of the given filename -1 -> Error 0 -> Lossless 1 -> Lossy

#### 10.309.4.8 GetMD5DataImage()

```
static const char* const* gdcm::Testing::GetMD5DataImage (
    unsigned int file ) [static]
```

#### 10.309.4.9 GetMD5DataImages()

```
static MD5DataImagesType gdcm::Testing::GetMD5DataImages ( ) [static]
```

#### 10.309.4.10 GetMD5FromBrokenFile()

```
static const char* gdcm::Testing::GetMD5FromBrokenFile (
    const char * filepath ) [static]
```

Return what should have been the md5 of file 'filepath' This is based on current GDCM implementation to decipher a broken DICOM file.

#### 10.309.4.11 GetMD5FromFile()

```
static const char* gdcm::Testing::GetMD5FromFile (
    const char * filepath ) [static]
```

#### 10.309.4.12 GetMediaStorageDataFile()

```
static const char* const* gdcm::Testing::GetMediaStorageDataFile (
    unsigned int file ) [static]
```

#### 10.309.4.13 GetMediaStorageDataFiles()

```
static MediaStorageDataFilesType gdcm::Testing::GetMediaStorageDataFiles ( ) [static]
```

#### 10.309.4.14 GetMediaStorageFromFile()

```
static const char* gdcM::Testing::GetMediaStorageFromFile (
    const char * filepath ) [static]
```

##### Examples

[MetaImageMD5Activiz.cs](#), and [TestReader.cxx](#).

#### 10.309.4.15 GetNumberOfFileNames()

```
static unsigned int gdcM::Testing::GetNumberOfFileNames ( ) [static]
```

##### Examples

[MetaImageMD5Activiz.cs](#).

#### 10.309.4.16 GetNumberOfMD5DataImages()

```
static unsigned int gdcM::Testing::GetNumberOfMD5DataImages ( ) [static]
```

#### 10.309.4.17 GetNumberOfMediaStorageDataFiles()

```
static unsigned int gdcM::Testing::GetNumberOfMediaStorageDataFiles ( ) [static]
```

#### 10.309.4.18 GetPixelSpacingDataRoot()

```
static const char* gdcM::Testing::GetPixelSpacingDataRoot ( ) [static]
```

Return the GDCM PIXEL SPACING DATA ROOT (See David Clunie website for dataset)



#### 10.309.4.19 GetSelectedPrivateGroupOffsetFromFile()

```
static std::streamoff gdcm::Testing::GetSelectedPrivateGroupOffsetFromFile (
    const char * filepath ) [static]
```

Return the offset just after private attribute (0009,0010,"GEMS\_IDEN\_01") if found. Otherwise the offset of the next attribute -1 if not found

#### 10.309.4.20 GetSelectedTagsOffsetFromFile()

```
static std::streamoff gdcm::Testing::GetSelectedTagsOffsetFromFile (
    const char * filepath ) [static]
```

Return the offset just after Pixel Data Length (7fe0,0000) if found. Otherwise the offset of the very first pixel cell in Pixel Data -1 if not found

#### 10.309.4.21 GetSourceDirectory()

```
static const char* gdcm::Testing::GetSourceDirectory ( ) [static]
```

##### Examples

[BasicAnonymizer.cs](#), and [ClinicalTriallIdentificationWorkflow.cs](#).

#### 10.309.4.22 GetStreamOffsetFromFile()

```
static std::streamoff gdcm::Testing::GetStreamOffsetFromFile (
    const char * filepath ) [static]
```

Return the offset of the very first pixel cell in the PixelData -1 if not found

#### 10.309.4.23 GetTempDirectory()

```
static const char* gdcm::Testing::GetTempDirectory (
    const char * subdir = nullptr ) [static]
```

NOT THREAD SAFE Returns the temp directory as used in testing needing to output data:

##### Examples

[MetalImageMD5Activiz.cs](#).

#### 10.309.4.24 GetTempDirectoryW()

```
static const wchar_t* gdcM::Testing::GetTempDirectoryW (
    const wchar_t * subdir = nullptr ) [static]
```

NOT THREAD SAFE.

#### 10.309.4.25 GetTempFilename()

```
static const char* gdcM::Testing::GetTempFilename (
    const char * filename,
    const char * subdir = nullptr ) [static]
```

NOT THREAD SAFE.

#### Examples

[MetalImageMD5Activiz.cs](#).

#### 10.309.4.26 GetTempFilenameW()

```
static const wchar_t* gdcM::Testing::GetTempFilenameW (
    const wchar_t * filename,
    const wchar_t * subdir = nullptr ) [static]
```

NOT THREAD SAFE.

#### 10.309.4.27 Print()

```
void gdcM::Testing::Print (
    std::ostream & os = std::cout )
```

Print.

The documentation for this class was generated from the following file:

- [gdcMTesting.h](#)

## 10.310 gdcm::Trace Class Reference

[Trace](#).

```
#include <gdcmTrace.h>
```

### Public Member Functions

- [Trace](#) ()
- [~Trace](#) ()

### Static Public Member Functions

- static void [DebugOff](#) ()
- static void [DebugOn](#) ()
- static void [ErrorOff](#) ()
- static void [ErrorOn](#) ()
- static bool [GetDebugFlag](#) ()
- static std::ostream & [GetDebugStream](#) ()
- static bool [GetErrorFlag](#) ()
- static std::ostream & [GetErrorStream](#) ()
- static std::ostream & [GetStream](#) ()
- static bool [GetWarningFlag](#) ()
- static std::ostream & [GetWarningStream](#) ()
- static void [SetDebug](#) (bool debug)  
*Turn debug messages on (default: false)*
- static void [SetDebugStream](#) (std::ostream &os)  
*Explicitly set the stream which receive Debug messages:*
- static void [SetError](#) (bool debug)  
*Turn error messages on (default: true)*
- static void [SetErrorStream](#) (std::ostream &os)  
*Explicitly set the stream which receive Error messages:*
- static void [SetStream](#) (std::ostream &os)
- static void [SetStreamToFile](#) (const char \*filename)
- static void [SetWarning](#) (bool debug)  
*Turn warning messages on (default: true)*
- static void [SetWarningStream](#) (std::ostream &os)  
*Explicitly set the stream which receive Warning messages:*
- static void [WarningOff](#) ()
- static void [WarningOn](#) ()

### 10.310.1 Detailed Description

[Trace](#).

Debug / Warning and Error are encapsulated in this class by default the [Trace](#) class will redirect any debug/warning/error to `std::cerr`. Unless `SetStream` was specified with another (open) stream or `SetStreamToFile` was specified to a writable file on the system.

#### Warning

All string messages are removed during compilation time when compiled with `CMAKE_BUILD_TYPE` being set to either:

- Release
- `MinSizeRel` It is recommended to compile with `RelWithDebInfo` and/or `Debug` during prototyping of applications.

### 10.310.2 Constructor & Destructor Documentation

#### 10.310.2.1 `Trace()`

```
gdcM::Trace::Trace ( )
```

#### 10.310.2.2 `~Trace()`

```
gdcM::Trace::~~Trace ( )
```

### 10.310.3 Member Function Documentation

#### 10.310.3.1 `DebugOff()`

```
static void gdcM::Trace::DebugOff ( ) [static]
```

#### Examples

[MetalImageMD5Activiz.cs](#), and [TestReader.cxx](#).

### 10.310.3.2 DebugOn()

```
static void gdcM::Trace::DebugOn ( ) [static]
```

#### Examples

[CreateFakePET.cxx](#), [Fake\\_Image\\_Using\\_Stream\\_Image\\_Writer.cxx](#), and [StreamImageReaderTest.cxx](#).

### 10.310.3.3 ErrorOff()

```
static void gdcM::Trace::ErrorOff ( ) [static]
```

#### Examples

[MetalImageMD5Activiz.cs](#).

### 10.310.3.4 ErrorOn()

```
static void gdcM::Trace::ErrorOn ( ) [static]
```

### 10.310.3.5 GetDebugFlag()

```
static bool gdcM::Trace::GetDebugFlag ( ) [static]
```

### 10.310.3.6 GetDebugStream()

```
static std::ostream& gdcM::Trace::GetDebugStream ( ) [static]
```

### 10.310.3.7 GetErrorFlag()

```
static bool gdcM::Trace::GetErrorFlag ( ) [static]
```

### 10.310.3.8 GetErrorStream()

```
static std::ostream& gdcM::Trace::GetErrorStream ( ) [static]
```

### 10.310.3.9 GetStream()

```
static std::ostream& gdcM::Trace::GetStream ( ) [static]
```

### 10.310.3.10 GetWarningFlag()

```
static bool gdcM::Trace::GetWarningFlag ( ) [static]
```

### 10.310.3.11 GetWarningStream()

```
static std::ostream& gdcM::Trace::GetWarningStream ( ) [static]
```

### 10.310.3.12 SetDebug()

```
static void gdcM::Trace::SetDebug (
    bool debug ) [static]
```

Turn debug messages on (default: false)

#### Examples

[DumpToSQLITE3.cxx](#).

### 10.310.3.13 SetDebugStream()

```
static void gdcM::Trace::SetDebugStream (
    std::ostream & os ) [static]
```

Explicitly set the stream which receive Debug messages:

### 10.310.3.14 SetError()

```
static void gdcM::Trace::SetError (
    bool debug ) [static]
```

Turn error messages on (default: true)

### 10.310.3.15 SetErrorStream()

```
static void gdcM::Trace::SetErrorStream (
    std::ostream & os ) [static]
```

Explicitly set the stream which receive Error messages:

#### Examples

[CStoreQtProgress.cxx](#).

### 10.310.3.16 SetStream()

```
static void gdcM::Trace::SetStream (
    std::ostream & os ) [static]
```

Explicitly set the ostream for [gdcM::Trace](#) to report to This will set the DebugStream, WarningStream and ErrorStream at once:

### 10.310.3.17 SetStreamToFile()

```
static void gdcM::Trace::SetStreamToFile (
    const char * filename ) [static]
```

Explicitly set the filename for [gdcM::Trace](#) to report to The file will be created (it will not append to existing file)

### 10.310.3.18 SetWarning()

```
static void gdcM::Trace::SetWarning (
    bool debug ) [static]
```

Turn warning messages on (default: true)

#### Examples

[DumpToSQLITE3.cxx](#).

### 10.310.3.19 SetWarningStream()

```
static void gdcM::Trace::SetWarningStream (
    std::ostream & os ) [static]
```

Explicitly set the stream which receive Warning messages:

### 10.310.3.20 WarningOff()

```
static void gdcM::Trace::WarningOff ( ) [static]
```

#### Examples

[MetalImageMD5Activiz.cs](#), and [TestReader.cxx](#).

### 10.310.3.21 WarningOn()

```
static void gdcM::Trace::WarningOn ( ) [static]
```

#### Examples

[Fake\\_Image\\_Using\\_Stream\\_Image\\_Writer.cxx](#), and [StreamImageReaderTest.cxx](#).

The documentation for this class was generated from the following file:

- [gdcMTrace.h](#)

## 10.311 gdcM::TransferSyntax Class Reference

Class to manipulate Transfer Syntax.

```
#include <gdcMTransferSyntax.h>
```



## Public Types

- enum [NegociatedType](#) {  
    [Unknown](#) = 0 ,  
    [Explicit](#) ,  
    [Implicit](#) }
- enum [TSType](#) {  
    [ImplicitVRLittleEndian](#) = 0 ,  
    [ImplicitVRBigEndianPrivateGE](#) ,  
    [ExplicitVRLittleEndian](#) ,  
    [DeflatedExplicitVRLittleEndian](#) ,  
    [ExplicitVRBigEndian](#) ,  
    [JPEGBaselineProcess1](#) ,  
    [JPEGExtendedProcess2\\_4](#) ,  
    [JPEGExtendedProcess3\\_5](#) ,  
    [JPEGsSpectralSelectionProcess6\\_8](#) ,  
    [JPEGFullProgressionProcess10\\_12](#) ,  
    [JPEGLosslessProcess14](#) ,  
    [JPEGLosslessProcess14\\_1](#) ,  
    [JPEGLSLossless](#) ,  
    [JPEGLSNearLossless](#) ,  
    [JPEG2000Lossless](#) ,  
    [JPEG2000](#) ,  
    [JPEG2000Part2Lossless](#) ,  
    [JPEG2000Part2](#) ,  
    [RLELossless](#) ,  
    [MPEG2MainProfile](#) ,  
    [ImplicitVRBigEndianACRNEMA](#) ,  
    [WeirdPapryus](#) ,  
    [CT\\_private\\_ELE](#) ,  
    [JPIPReferenced](#) ,  
    [MPEG2MainProfileHighLevel](#) ,  
    [MPEG4AVCH264HighProfileLevel4\\_1](#) ,  
    [MPEG4AVCH264BDcompatibleHighProfileLevel4\\_1](#) ,  
    [TS\\_END](#) }

## Public Member Functions

- [TransferSyntax](#) ([TSType](#) type=[ImplicitVRLittleEndian](#))
- [bool CanStoreLossy](#) () const
- [NegociatedType GetNegociatedType](#) () const
- [const char \\* GetString](#) () const
- [SwapCode GetSwapCode](#) () const
- [bool IsEncapsulated](#) () const
- [bool IsEncoded](#) () const
- [bool IsExplicit](#) () const
- [bool IsImplicit](#) () const
- [bool IsLossless](#) () const
- [bool IsLossy](#) () const
- [bool IsValid](#) () const
- [operator TSType](#) () const

## Static Public Member Functions

- static const char \* [GetTSSString](#) (TSType ts)
- static TSType [GetTSType](#) (const char \*str)

## Friends

- std::ostream & [operator<<](#) (std::ostream &os, const [TransferSyntax](#) &ts)

### 10.311.1 Detailed Description

Class to manipulate Transfer Syntax.

#### Note

TRANSFER SYNTAX (Standard and Private): A set of encoding rules that allow Application Entities to unambiguously negotiate the encoding techniques (e.g., Data [Element](#) structure, byte ordering, compression) they are able to support, thereby allowing these Application Entities to communicate.

**Todo** : The implementation is completely retarded -> see [gdcm::UIDs](#) for a replacement We need: IsSupported We need preprocess of raw/xml file We need GetFullName()

Need a notion of Private Syntax. As defined in PS 3.5. Section 9.2

#### See also

[UIDs](#)

#### Examples

[GetJPEGSamplePrecision.cxx](#), [LargeVRDSExplicit.cxx](#), and [MakeTemplate.cxx](#).

### 10.311.2 Member Enumeration Documentation

#### 10.311.2.1 NegotiatedType

enum [gdcm::TransferSyntax::NegociatedType](#)

#### Enumerator

Unknown	
Explicit	
Implicit	

### 10.311.2.2 TSType

enum `gdcM::TransferSyntax::TSType`

#### Enumerator

ImplicitVRLittleEndian	
ImplicitVRBigEndianPrivateGE	
ExplicitVRLittleEndian	
DeflatedExplicitVRLittleEndian	
ExplicitVRBigEndian	
JPEGBaselineProcess1	
JPEGExtendedProcess2_4	
JPEGExtendedProcess3_5	
JPEGSpectralSelectionProcess6_8	
JPEGFullProgressionProcess10_12	
JPEGLosslessProcess14	
JPEGLosslessProcess14_1	
JPEGLSLossless	
JPEGLSNearLossless	
JPEG2000Lossless	
JPEG2000	
JPEG2000Part2Lossless	
JPEG2000Part2	
RLELossless	
MPEG2MainProfile	
ImplicitVRBigEndianACRNEMA	
WeirdPapryus	
CT_private_ELE	
JPIPReferenced	
MPEG2MainProfileHighLevel	
MPEG4AVCH264HighProfileLevel4_1	
MPEG4AVCH264BDcompatibleHighProfileLevel4↔ _1	
TS_END	

### 10.311.3 Constructor & Destructor Documentation

### 10.311.3.1 TransferSyntax()

```
gdcm::TransferSyntax::TransferSyntax (
    TSType type = ImplicitVRLittleEndian ) [inline]
```

## 10.311.4 Member Function Documentation

### 10.311.4.1 CanStoreLossy()

```
bool gdcm::TransferSyntax::CanStoreLossy ( ) const
```

return true if TransFer Syntax Allow storing of Lossy Pixel Data

### 10.311.4.2 GetNegociatedType()

```
NegociatedType gdcm::TransferSyntax::GetNegociatedType ( ) const
```

### 10.311.4.3 GetString()

```
const char* gdcm::TransferSyntax::GetString ( ) const [inline]
```

References GetTSString().

### 10.311.4.4 GetSwapCode()

```
SwapCode gdcm::TransferSyntax::GetSwapCode ( ) const
```

**Deprecated** Return the [SwapCode](#) associated with the Transfer Syntax. Be careful with the special GE private syntax the [DataSet](#) is written in little endian but the Pixel Data is in Big Endian.

#### 10.311.4.5 GetTSString()

```
static const char* gdcm::TransferSyntax::GetTSString (
    TSType ts ) [static]
```

##### Examples

[LargeVRDSExplicit.cxx](#).

Referenced by GetString().

#### 10.311.4.6 GetTSType()

```
static TSType gdcm::TransferSyntax::GetTSType (
    const char * str ) [static]
```

#### 10.311.4.7 IsEncapsulated()

```
bool gdcm::TransferSyntax::IsEncapsulated ( ) const
```

##### Examples

[ExtractIconFromFile.cxx](#).

#### 10.311.4.8 IsEncoded()

```
bool gdcm::TransferSyntax::IsEncoded ( ) const
```

#### 10.311.4.9 IsExplicit()

```
bool gdcm::TransferSyntax::IsExplicit ( ) const
```

#### 10.311.4.10 IsImplicit()

```
bool gdcm::TransferSyntax::IsImplicit ( ) const
```

#### 10.311.4.11 IsLossless()

```
bool gdcm::TransferSyntax::IsLossless ( ) const
```

Return true if the transfer syntax algorithm is a lossless algorithm

#### 10.311.4.12 IsLossy()

```
bool gdcm::TransferSyntax::IsLossy ( ) const
```

Return true if the transfer syntax algorithm is a lossy algorithm

#### 10.311.4.13 IsValid()

```
bool gdcm::TransferSyntax::IsValid ( ) const [inline]
```

#### 10.311.4.14 operator TSType()

```
gdcm::TransferSyntax::operator TSType ( ) const [inline]
```

### 10.311.5 Friends And Related Function Documentation

#### 10.311.5.1 operator<<

```
std::ostream& operator<< (
    std::ostream & os,
    const TransferSyntax & ts ) [friend]
```

The documentation for this class was generated from the following file:

- [gdcmTransferSyntax.h](#)

## 10.312 gdcm::network::TransferSyntaxSub Class Reference

[TransferSyntaxSub](#).

```
#include <gdcmTransferSyntaxSub.h>
```

### Public Member Functions

- [TransferSyntaxSub](#) ()
- const char \* [GetName](#) () const
- bool [operator==](#) (const [TransferSyntaxSub](#) &ts) const
- void [Print](#) (std::ostream &os) const
- std::istream & [Read](#) (std::istream &is)
- void [SetName](#) (const char \*name)
- void [SetNameFromUID](#) (UIDs::TSName tsname)
- size\_t [Size](#) () const
- const std::ostream & [Write](#) (std::ostream &os) const

### 10.312.1 Detailed Description

[TransferSyntaxSub](#).

[Table](#) 9-15 TRANSFER SYNTAX SUB-ITEM FIELDS

TODO what is the goal of :

[Table](#) 9-19 TRANSFER SYNTAX SUB-ITEM FIELDS

### 10.312.2 Constructor & Destructor Documentation

#### 10.312.2.1 TransferSyntaxSub()

```
gdcm::network::TransferSyntaxSub::TransferSyntaxSub ( )
```

### 10.312.3 Member Function Documentation

### 10.312.3.1 GetName()

```
const char* gdcmm::network::TransferSyntaxSub::GetName ( ) const [inline]
```

### 10.312.3.2 operator==()

```
bool gdcmm::network::TransferSyntaxSub::operator== (
    const TransferSyntaxSub & ts ) const [inline]
```

### 10.312.3.3 Print()

```
void gdcmm::network::TransferSyntaxSub::Print (
    std::ostream & os ) const
```

### 10.312.3.4 Read()

```
std::istream& gdcmm::network::TransferSyntaxSub::Read (
    std::istream & is )
```

### 10.312.3.5 SetName()

```
void gdcmm::network::TransferSyntaxSub::SetName (
    const char * name )
```

### 10.312.3.6 SetNameFromUID()

```
void gdcmm::network::TransferSyntaxSub::SetNameFromUID (
    UIDs::TSName tsname )
```



### 10.312.3.7 Size()

```
size_t gdcm::network::TransferSyntaxSub::Size ( ) const
```

### 10.312.3.8 Write()

```
const std::ostream& gdcm::network::TransferSyntaxSub::Write (
    std::ostream & os ) const
```

The documentation for this class was generated from the following file:

- [gdcmTransferSyntaxSub.h](#)

## 10.313 gdcm::network::Transition Struct Reference

```
#include <gdcmULTransitionTable.h>
```

Collaboration diagram for gdcm::network::Transition:

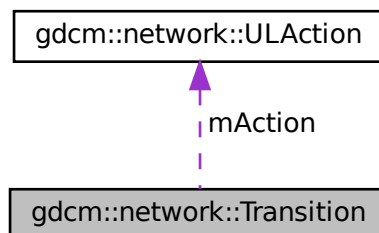

### Public Member Functions

- [Transition](#) ()
- [Transition](#) (int inEndState, [ULAction](#) \*inAction)
- [~Transition](#) ()

### Static Public Member Functions

- static [Transition](#) \* [MakeNew](#) (int inEndState, [ULAction](#) \*inAction)

## Public Attributes

- [ULAction](#) \* `mAction`
- int `mEnd`

### 10.313.1 Constructor & Destructor Documentation

#### 10.313.1.1 Transition() [1/2]

```
gdcmm::network::Transition::Transition ( ) [inline]
```

References `gdcmm::network::eStaDoesNotExist`, `mAction`, and `mEnd`.

Referenced by `MakeNew()`.

#### 10.313.1.2 ~Transition()

```
gdcmm::network::Transition::~~Transition ( ) [inline]
```

References `mAction`.

#### 10.313.1.3 Transition() [2/2]

```
gdcmm::network::Transition::Transition (
    int inEndState,
    ULAction * inAction ) [inline]
```

References `mAction`, and `mEnd`.

### 10.313.2 Member Function Documentation

#### 10.313.2.1 MakeNew()

```
static Transition* gdcmm::network::Transition::MakeNew (
    int inEndState,
    ULAction * inAction ) [inline], [static]
```

References `Transition()`.

### 10.313.3 Member Data Documentation

#### 10.313.3.1 mAction

[ULAction\\*](#) gdcm::network::Transition::mAction

Referenced by [Transition\(\)](#), and [~Transition\(\)](#).

#### 10.313.3.2 mEnd

int gdcm::network::Transition::mEnd

Referenced by [Transition\(\)](#).

The documentation for this struct was generated from the following file:

- [gdcmULTransitionTable.h](#)

## 10.314 gdcm::Type Class Reference

[Type](#).

```
#include <gdcmType.h>
```

### Public Types

- enum [TypeType](#) {  
    [T1](#) = 0 ,  
    [T1C](#) ,  
    [T2](#) ,  
    [T2C](#) ,  
    [T3](#) ,  
    [UNKNOWN](#) }

### Public Member Functions

- [Type](#) ([TypeType](#) type=[UNKNOWN](#))
- [operator TypeType](#) () const

## Static Public Member Functions

- static const char \* [GetTypeString](#) ([TypeType](#) type)
- static [TypeType](#) [GetTypeType](#) (const char \*type)

## Friends

- std::ostream & [operator<<](#) (std::ostream &os, const [Type](#) &vr)

### 10.314.1 Detailed Description

[Type](#).

#### Note

PS 3.5 7.4 DATA ELEMENT TYPE 7.4.1 TYPE 1 REQUIRED DATA ELEMENTS 7.4.2 TYPE 1C CONDITIONAL DATA ELEMENTS 7.4.3 TYPE 2 REQUIRED DATA ELEMENTS 7.4.4 TYPE 2C CONDITIONAL DATA ELEMENTS 7.4.5 TYPE 3 OPTIONAL DATA ELEMENTS

The intent of [Type](#) 2 Data Elements is to allow a zero length to be conveyed when the operator or application does not know its value or has a specific reason for not specifying its value. It is the intent that the device should support these Data Elements.

### 10.314.2 Member Enumeration Documentation

#### 10.314.2.1 TypeType

```
enum gdcmm::Type::TypeType
```

#### Enumerator

T1	
T1C	
T2	
T2C	
T3	
UNKNOWN	

### 10.314.3 Constructor & Destructor Documentation

### 10.314.3.1 Type()

```
gdcM::Type::Type (
    TypeType type = UNKNOWN ) [inline]
```

## 10.314.4 Member Function Documentation

### 10.314.4.1 GetTypeString()

```
static const char* gdcM::Type::GetTypeString (
    TypeType type ) [static]
```

### 10.314.4.2 GetTypeType()

```
static TypeType gdcM::Type::GetTypeType (
    const char * type ) [static]
```

Referenced by `gdcM::ModuleEntry::ModuleEntry()`.

### 10.314.4.3 operator TypeType()

```
gdcM::Type::operator TypeType ( ) const [inline]
```

## 10.314.5 Friends And Related Function Documentation

### 10.314.5.1 operator<<

```
std::ostream& operator<< (
    std::ostream & os,
    const Type & vr ) [friend]
```

The documentation for this class was generated from the following file:

- [gdcMType.h](#)

## 10.315 gdcM::UI Struct Reference

```
#include <gdcMVR.h>
```

### Public Attributes

- char [Internal](#) [64+1]

### Friends

- std::ostream & [operator<<](#) (std::ostream &\_os, const [UI](#) &\_val)

### 10.315.1 Friends And Related Function Documentation

#### 10.315.1.1 operator<<

```
std::ostream& operator<< (  
    std::ostream & _os,  
    const UI & _val ) [friend]
```

### 10.315.2 Member Data Documentation

#### 10.315.2.1 Internal

```
char gdcM::UI::Internal[64+1]
```

The documentation for this struct was generated from the following file:

- [gdcMVR.h](#)

## 10.316 gdcM::UIDGenerator Class Reference

Class for generating unique UID.

```
#include <gdcMUIDGenerator.h>
```

## Public Member Functions

- [UIDGenerator](#) ()  
*By default the root of a UID is a GDCM Root...*
- const char \* [Generate](#) ()

## Static Public Member Functions

- static const char \* [GetGDCMUID](#) ()  
*Return the default (GDCM) root UID:*
- static const char \* [GetRoot](#) ()
- static bool [IsValid](#) (const char \*uid)
- static void [SetRoot](#) (const char \*root)

## Static Protected Member Functions

- static bool [GenerateUUID](#) (unsigned char \*uuid\_data)

### 10.316.1 Detailed Description

Class for generating unique UID.

#### Note

bla [Usage](#): When constructing a [Series](#) or [Study](#) UID, user *has* to keep around the UID, otherwise the UID Generator will simply forget the value and create a new UID.

#### Examples

[CreateJPIPDataSet.cxx](#), [EncapsulateFileInRawData.cxx](#), [Extracting\\_All\\_Resolution.cxx](#), [Fake\\_Image\\_Using\\_Stream\\_Image\\_Writer](#), [GenAllVR.cxx](#), [GenFakeIdentifyFile.cxx](#), [GenFakeImage.cxx](#), [GetSubSequenceData.cxx](#), [StreamImageReaderTest.cxx](#), [TemplateEmptyImage.cxx](#), and [uid\\_unique.cxx](#).

### 10.316.2 Constructor & Destructor Documentation

#### 10.316.2.1 UIDGenerator()

```
gdcm::UIDGenerator::UIDGenerator ( ) [inline]
```

By default the root of a UID is a GDCM Root...

### 10.316.3 Member Function Documentation

#### 10.316.3.1 Generate()

```
const char* gdcM::UIDGenerator::Generate ( )
```

Internally uses a `std::string`, so two calls have the same pointer ! save into a `std::string` In summary do not write code like that: `const char *uid1 = uid.Generate(); const char *uid2 = uid.Generate();` since `uid1 == uid2`

#### Examples

[CreateJPIPDataSet.cxx](#), [EncapsulateFileInRawData.cxx](#), [Extracting\\_All\\_Resolution.cxx](#), [Fake\\_Image\\_Using\\_Stream\\_Image\\_Writer](#), [GenAllVR.cxx](#), [GenFakeIdentifyFile.cxx](#), [GenFakeImage.cxx](#), [GetSubSequenceData.cxx](#), [StreamImageReaderTest.cxx](#), [TemplateEmptyImage.cxx](#), and [uid\\_unique.cxx](#).

#### 10.316.3.2 GenerateUUID()

```
static bool gdcM::UIDGenerator::GenerateUUID (
    unsigned char * uuid_data ) [static], [protected]
```

#### 10.316.3.3 GetGDCMUID()

```
static const char* gdcM::UIDGenerator::GetGDCMUID ( ) [static]
```

Return the default (GDCM) root UID:

#### 10.316.3.4 GetRoot()

```
static const char* gdcM::UIDGenerator::GetRoot ( ) [static]
```

#### Examples

[ClinicalTrialIdentificationWorkflow.cs](#), [ReformatFile.cs](#), and [StandardizeFiles.cs](#).



### 10.316.3.5 IsValid()

```
static bool gdcm::UIDGenerator::IsValid (
    const char * uid ) [static]
```

Find out if the string is a valid UID or not

**Todo** : Move that in DataStructureAndEncoding (see FileMetaInformation::CheckFileMetaInformation)

### 10.316.3.6 SetRoot()

```
static void gdcm::UIDGenerator::SetRoot (
    const char * root ) [static]
```

The current implementation in GDCM make use of the UUID implementation (RFC 4122) and has been successfully been tested for a root of size 26 bytes. Any longer root should work (the [Generate\(\)](#) function will return a string), but will truncate the high bits of the 128bits UUID until the generated string fits on 64 bits. The authors disclaims any responsibility for guaranteeing uniqueness of [UIDs](#) when the root is longer than 26 bytes.

#### Examples

[ClinicalTrialIdentificationWorkflow.cs](#), [ReformatFile.cs](#), [StandardizeFiles.cs](#), and [uid\\_unique.cxx](#).

The documentation for this class was generated from the following file:

- [gdcmUIDGenerator.h](#)

## 10.317 gdcm::UIDs Class Reference

all known uids

```
#include <gdcmUIDs.h>
```

## Public Types

- typedef const char \*const (\* TransferSyntaxStringsType)[2]
- enum TSName {
  - VerificationSOPClass = 1 ,
  - ImplicitVRLittleEndianDefaultTransferSyntaxforDICOM = 2 ,
  - ExplicitVRLittleEndian = 3 ,
  - DeflatedExplicitVRLittleEndian = 4 ,
  - ExplicitVRBigEndian = 5 ,
  - JPEGBaselineProcess1DefaultTransferSyntaxforLossyJPEG8BitImageCompression = 6 ,
  - JPEGExtendedProcess24DefaultTransferSyntaxforLossyJPEG12BitImageCompressionProcess4only = 7 ,
  - JPEGExtendedProcess35Retired = 8 ,
  - JPEGSpectralSelectionNonHierarchicalProcess68Retired = 9 ,
  - JPEGSpectralSelectionNonHierarchicalProcess79Retired = 10 ,
  - JPEGFULLProgressionNonHierarchicalProcess1012Retired = 11 ,
  - JPEGFULLProgressionNonHierarchicalProcess1113Retired = 12 ,
  - JPEGLosslessNonHierarchicalProcess14 = 13 ,
  - JPEGLosslessNonHierarchicalProcess15Retired = 14 ,
  - JPEGExtendedHierarchicalProcess1618Retired = 15 ,
  - JPEGExtendedHierarchicalProcess1719Retired = 16 ,
  - JPEGSpectralSelectionHierarchicalProcess2022Retired = 17 ,
  - JPEGSpectralSelectionHierarchicalProcess2123Retired = 18 ,
  - JPEGFULLProgressionHierarchicalProcess2426Retired = 19 ,
  - JPEGFULLProgressionHierarchicalProcess2527Retired = 20 ,
  - JPEGLosslessHierarchicalProcess28Retired = 21 ,
  - JPEGLosslessHierarchicalProcess29Retired = 22 ,
  - JPEGLosslessNonHierarchicalFirstOrderPredictionProcess14SelectionValue1DefaultTransferSyntaxforLosslessJPEGImageCompression = 23 ,
  - JPEGLSLosslessImageCompression = 24 ,
  - JPEGLSLossyNearLosslessImageCompression = 25 ,
  - JPEG2000ImageCompressionLosslessOnly = 26 ,
  - JPEG2000ImageCompression = 27 ,
  - JPEG2000Part2MulticomponentImageCompressionLosslessOnly = 28 ,
  - JPEG2000Part2MulticomponentImageCompression = 29 ,
  - JPIPReferenced = 30 ,
  - JPIPReferencedDeflate = 31 ,
  - MPEG2MainProfileMainLevel = 32 ,
  - RLELossless = 33 ,
  - RFC2557MIMEencapsulation = 34 ,
  - XMLEncoding = 35 ,
  - MediaStorageDirectoryStorage = 36 ,
  - TalairachBrainAtlasFrameofReference = 37 ,
  - SPM2T1FrameofReference = 38 ,
  - SPM2T2FrameofReference = 39 ,
  - SPM2PDFFrameofReference = 40 ,
  - SPM2EPIFrameofReference = 41 ,
  - SPM2FILT1FrameofReference = 42 ,
  - SPM2PETFrameofReference = 43 ,
  - SPM2TRANSMFrameofReference = 44 ,
  - SPM2SPECTFrameofReference = 45 ,
  - SPM2GRAYFrameofReference = 46 ,
  - SPM2WHITEFrameofReference = 47 ,
  - SPM2CSFFrameofReference = 48 ,
  - SPM2BRAINMASKFrameofReference = 49 ,

SPM2AVG305T1FrameofReference = 50 ,  
SPM2AVG152T1FrameofReference = 51 ,  
SPM2AVG152T2FrameofReference = 52 ,  
SPM2AVG152PDFrameofReference = 53 ,  
SPM2SINGLESUBJT1FrameofReference = 54 ,  
ICBM452T1FrameofReference = 55 ,  
ICBMSingleSubjectMRIFrameofReference = 56 ,  
BasicStudyContentNotificationSOPClassRetired = 57 ,  
StorageCommitmentPushModelSOPClass = 58 ,  
StorageCommitmentPushModelSOPInstance = 59 ,  
StorageCommitmentPullModelSOPClassRetired = 60 ,  
StorageCommitmentPullModelSOPInstanceRetired = 61 ,  
ProceduralEventLoggingSOPClass = 62 ,  
ProceduralEventLoggingSOPInstance = 63 ,  
SubstanceAdministrationLoggingSOPClass = 64 ,  
SubstanceAdministrationLoggingSOPInstance = 65 ,  
DICOMUIDRegistry = 66 ,  
DICOMControlledTerminology = 67 ,  
DICOMApplicationContextName = 68 ,  
DetachedPatientManagementSOPClassRetired = 69 ,  
DetachedPatientManagementMetaSOPClassRetired = 70 ,  
DetachedVisitManagementSOPClassRetired = 71 ,  
DetachedStudyManagementSOPClassRetired = 72 ,  
StudyComponentManagementSOPClassRetired = 73 ,  
ModalityPerformedProcedureStepSOPClass = 74 ,  
ModalityPerformedProcedureStepRetrieveSOPClass = 75 ,  
ModalityPerformedProcedureStepNotificationSOPClass = 76 ,  
DetachedResultsManagementSOPClassRetired = 77 ,  
DetachedResultsManagementMetaSOPClassRetired = 78 ,  
DetachedStudyManagementMetaSOPClassRetired = 79 ,  
DetachedInterpretationManagementSOPClassRetired = 80 ,  
StorageServiceClass = 81 ,  
BasicFilmSessionSOPClass = 82 ,  
BasicFilmBoxSOPClass = 83 ,  
BasicGrayscaleImageBoxSOPClass = 84 ,  
BasicColorImageBoxSOPClass = 85 ,  
ReferencedImageBoxSOPClassRetired = 86 ,  
BasicGrayscalePrintManagementMetaSOPClass = 87 ,  
ReferencedGrayscalePrintManagementMetaSOPClassRetired = 88 ,  
PrintJobSOPClass = 89 ,  
BasicAnnotationBoxSOPClass = 90 ,  
PrinterSOPClass = 91 ,  
PrinterConfigurationRetrievalSOPClass = 92 ,  
PrinterSOPInstance = 93 ,  
PrinterConfigurationRetrievalSOPInstance = 94 ,  
BasicColorPrintManagementMetaSOPClass = 95 ,  
ReferencedColorPrintManagementMetaSOPClassRetired = 96 ,  
VOILUTBoxSOPClass = 97 ,  
PresentationLUTSOPClass = 98 ,  
ImageOverlayBoxSOPClassRetired = 99 ,  
BasicPrintImageOverlayBoxSOPClassRetired = 100 ,  
PrintQueueSOPInstanceRetired = 101 ,  
PrintQueueManagementSOPClassRetired = 102 ,  
StoredPrintStorageSOPClassRetired = 103 ,

[HardcopyGrayscaleImageStorageSOPClassRetired](#) = 104 ,  
[HardcopyColorImageStorageSOPClassRetired](#) = 105 ,  
[PullPrintRequestSOPClassRetired](#) = 106 ,  
[PullStoredPrintManagementMetaSOPClassRetired](#) = 107 ,  
[MediaCreationManagementSOPClassUID](#) = 108 ,  
[ComputedRadiographyImageStorage](#) = 109 ,  
[DigitalXRayImageStorageForPresentation](#) = 110 ,  
[DigitalXRayImageStorageForProcessing](#) = 111 ,  
[DigitalMammographyXRayImageStorageForPresentation](#) = 112 ,  
[DigitalMammographyXRayImageStorageForProcessing](#) = 113 ,  
[DigitalIntraoralXRayImageStorageForPresentation](#) = 114 ,  
[DigitalIntraoralXRayImageStorageForProcessing](#) = 115 ,  
[CTImageStorage](#) = 116 ,  
[EnhancedCTImageStorage](#) = 117 ,  
[UltrasoundMultiframeImageStorageRetired](#) = 118 ,  
[UltrasoundMultiframeImageStorage](#) = 119 ,  
[MRIImageStorage](#) = 120 ,  
[EnhancedMRIImageStorage](#) = 121 ,  
[MRSpectroscopyStorage](#) = 122 ,  
[NuclearMedicineImageStorageRetired](#) = 123 ,  
[UltrasoundImageStorageRetired](#) = 124 ,  
[UltrasoundImageStorage](#) = 125 ,  
[SecondaryCaptureImageStorage](#) = 126 ,  
[MultiframeSingleBitSecondaryCaptureImageStorage](#) = 127 ,  
[MultiframeGrayscaleByteSecondaryCaptureImageStorage](#) = 128 ,  
[MultiframeGrayscaleWordSecondaryCaptureImageStorage](#) = 129 ,  
[MultiframeTrueColorSecondaryCaptureImageStorage](#) = 130 ,  
[StandaloneOverlayStorageRetired](#) = 131 ,  
[StandaloneCurveStorageRetired](#) = 132 ,  
[WaveformStorageTrialRetired](#) = 133 ,  
[ECG12leadWaveformStorage](#) = 134 ,  
[GeneralECGWaveformStorage](#) = 135 ,  
[AmbulatoryECGWaveformStorage](#) = 136 ,  
[HemodynamicWaveformStorage](#) = 137 ,  
[CardiacElectrophysiologyWaveformStorage](#) = 138 ,  
[BasicVoiceAudioWaveformStorage](#) = 139 ,  
[StandaloneModalityLUTStorageRetired](#) = 140 ,  
[StandaloneVOILUTStorageRetired](#) = 141 ,  
[GrayscaleSoftcopyPresentationStateStorageSOPClass](#) = 142 ,  
[ColorSoftcopyPresentationStateStorageSOPClass](#) = 143 ,  
[PseudoColorSoftcopyPresentationStateStorageSOPClass](#) = 144 ,  
[BlendingSoftcopyPresentationStateStorageSOPClass](#) = 145 ,  
[XRayAngiographicImageStorage](#) = 146 ,  
[EnhancedXAImageStorage](#) = 147 ,  
[XRayRadiofluoroscopicImageStorage](#) = 148 ,  
[EnhancedXRFImageStorage](#) = 149 ,  
[XRay3DAngiographicImageStorage](#) = 150 ,  
[XRay3DCraniofacialImageStorage](#) = 151 ,  
[XRayAngiographicBiPlaneImageStorageRetired](#) = 152 ,  
[NuclearMedicineImageStorage](#) = 153 ,  
[RawDataStorage](#) = 154 ,  
[SpatialRegistrationStorage](#) = 155 ,  
[SpatialFiducialsStorage](#) = 156 ,  
[DeformableSpatialRegistrationStorage](#) = 157 ,

SegmentationStorage = 158 ,  
RealWorldValueMappingStorage = 159 ,  
VLImageStorageTrialRetired = 160 ,  
VLMultiframeImageStorageTrialRetired = 161 ,  
VLEndoscopicImageStorage = 162 ,  
VideoEndoscopicImageStorage = 163 ,  
VLMicroscopicImageStorage = 164 ,  
VideoMicroscopicImageStorage = 165 ,  
VLSlideCoordinatesMicroscopicImageStorage = 166 ,  
VLPhotographicImageStorage = 167 ,  
VideoPhotographicImageStorage = 168 ,  
OphthalmicPhotography8BitImageStorage = 169 ,  
OphthalmicPhotography16BitImageStorage = 170 ,  
StereometricRelationshipStorage = 171 ,  
OphthalmicTomographyImageStorage = 172 ,  
TextSRStorageTrialRetired = 173 ,  
AudioSRStorageTrialRetired = 174 ,  
DetailSRStorageTrialRetired = 175 ,  
ComprehensiveSRStorageTrialRetired = 176 ,  
BasicTextSRStorage = 177 ,  
EnhancedSRStorage = 178 ,  
ComprehensiveSRStorage = 179 ,  
ProcedureLogStorage = 180 ,  
MammographyCADSRStorage = 181 ,  
KeyObjectSelectionDocumentStorage = 182 ,  
ChestCADSRStorage = 183 ,  
XRayRadiationDoseSRStorage = 184 ,  
EncapsulatedPDFStorage = 185 ,  
EncapsulatedCDASStorage = 186 ,  
PositronEmissionTomographyImageStorage = 187 ,  
StandalonePETCurveStorageRetired = 188 ,  
RTImageStorage = 189 ,  
RTDoseStorage = 190 ,  
RTStructureSetStorage = 191 ,  
RTBeamsTreatmentRecordStorage = 192 ,  
RTPlanStorage = 193 ,  
RTBrachyTreatmentRecordStorage = 194 ,  
RTTreatmentSummaryRecordStorage = 195 ,  
RTIonPlanStorage = 196 ,  
RTIonBeamsTreatmentRecordStorage = 197 ,  
PatientRootQueryRetrieveInformationModelFIND = 198 ,  
PatientRootQueryRetrieveInformationModelMOVE = 199 ,  
PatientRootQueryRetrieveInformationModelGET = 200 ,  
StudyRootQueryRetrieveInformationModelFIND = 201 ,  
StudyRootQueryRetrieveInformationModelMOVE = 202 ,  
StudyRootQueryRetrieveInformationModelGET = 203 ,  
PatientStudyOnlyQueryRetrieveInformationModelFINDRetired = 204 ,  
PatientStudyOnlyQueryRetrieveInformationModelMOVERetired = 205 ,  
PatientStudyOnlyQueryRetrieveInformationModelGETRetired = 206 ,  
ModalityWorklistInformationModelFIND = 207 ,  
GeneralPurposeWorklistInformationModelFIND = 208 ,  
GeneralPurposeScheduledProcedureStepSOPClass = 209 ,  
GeneralPurposePerformedProcedureStepSOPClass = 210 ,  
GeneralPurposeWorklistManagementMetaSOPClass = 211 ,

[InstanceAvailabilityNotificationSOPClass](#) = 212 ,  
[RTBeamsDeliveryInstructionStorageSupplement74FrozenDraft](#) = 213 ,  
[RTConventionalMachineVerificationSupplement74FrozenDraft](#) = 214 ,  
[RTIonMachineVerificationSupplement74FrozenDraft](#) = 215 ,  
[UnifiedWorklistandProcedureStepServiceClass](#) = 216 ,  
[UnifiedProcedureStepPushSOPClass](#) = 217 ,  
[UnifiedProcedureStepWatchSOPClass](#) = 218 ,  
[UnifiedProcedureStepPullSOPClass](#) = 219 ,  
[UnifiedProcedureStepEventSOPClass](#) = 220 ,  
[UnifiedWorklistandProcedureStepSOPInstance](#) = 221 ,  
[GeneralRelevantPatientInformationQuery](#) = 222 ,  
[BreastImagingRelevantPatientInformationQuery](#) = 223 ,  
[CardiacRelevantPatientInformationQuery](#) = 224 ,  
[HangingProtocolStorage](#) = 225 ,  
[HangingProtocolInformationModelFIND](#) = 226 ,  
[HangingProtocolInformationModelMOVE](#) = 227 ,  
[ProductCharacteristicsQuerySOPClass](#) = 228 ,  
[SubstanceApprovalQuerySOPClass](#) = 229 ,  
[dicomDeviceName](#) = 230 ,  
[dicomDescription](#) = 231 ,  
[dicomManufacturer](#) = 232 ,  
[dicomManufacturerModelName](#) = 233 ,  
[dicomSoftwareVersion](#) = 234 ,  
[dicomVendorData](#) = 235 ,  
[dicomAETitle](#) = 236 ,  
[dicomNetworkConnectionReference](#) = 237 ,  
[dicomApplicationCluster](#) = 238 ,  
[dicomAssociationInitiator](#) = 239 ,  
[dicomAssociationAcceptor](#) = 240 ,  
[dicomHostname](#) = 241 ,  
[dicomPort](#) = 242 ,  
[dicomSOPClass](#) = 243 ,  
[dicomTransferRole](#) = 244 ,  
[dicomTransferSyntax](#) = 245 ,  
[dicomPrimaryDeviceType](#) = 246 ,  
[dicomRelatedDeviceReference](#) = 247 ,  
[dicomPreferredCalledAETitle](#) = 248 ,  
[dicomTLSCyphersuite](#) = 249 ,  
[dicomAuthorizedNodeCertificateReference](#) = 250 ,  
[dicomThisNodeCertificateReference](#) = 251 ,  
[dicomInstalled](#) = 252 ,  
[dicomStationName](#) = 253 ,  
[dicomDeviceSerialNumber](#) = 254 ,  
[dicomInstitutionName](#) = 255 ,  
[dicomInstitutionAddress](#) = 256 ,  
[dicomInstitutionDepartmentName](#) = 257 ,  
[dicomIssuerOfPatientID](#) = 258 ,  
[dicomPreferredCallingAETitle](#) = 259 ,  
[dicomSupportedCharacterSet](#) = 260 ,  
[dicomConfigurationRoot](#) = 261 ,  
[dicomDevicesRoot](#) = 262 ,  
[dicomUniqueAETitlesRegistryRoot](#) = 263 ,  
[dicomDevice](#) = 264 ,  
[dicomNetworkAE](#) = 265 ,

[dicomNetworkConnection](#) = 266 ,  
[dicomUniqueAETitle](#) = 267 ,  
[dicomTransferCapability](#) = 268 ,  
[VLWholeSlideMicroscopyImageStorage](#) = 269 ,  
[EnhancedUSVolumeStorage](#) = 270 ,  
[SurfaceSegmentationStorage](#) = 271 ,  
[BreastTomosynthesisImageStorage](#) = 272 ,  
[LegacyConvertedEnhancedCTImageStorage](#) = 273 ,  
[LegacyConvertedEnhancedMRImageStorage](#) = 274 ,  
[LegacyConvertedEnhancedPETImageStorage](#) = 275 ,  
[MPEG2MainProfileHighLevel](#) = 276 ,  
[MPEG4AVCH\\_264HighProfileLevel4\\_1](#) = 277 ,  
[MPEG4AVCH\\_264BDcompatibleHighProfileLevel4\\_1](#) = 278 ,  
[PETColorPaletteSOPInstance](#) = 279 ,  
[HotMetalBlueColorPaletteSOPInstance](#) = 280 ,  
[PET20StepColorPaletteSOPInstance](#) = 281 ,  
[SpringColorPaletteSOPInstance](#) = 282 ,  
[SummerColorPaletteSOPInstance](#) = 283 ,  
[FallColorPaletteSOPInstance](#) = 284 ,  
[WinterColorPaletteSOPInstance](#) = 285 ,  
[Papyrus3ImplicitVRLittleEndian](#) = 286 ,  
[AdultMouseAnatomyOntology](#) = 287 ,  
[UberonOntology](#) = 288 ,  
[IntegratedTaxonomicInformationSystemITISTaxonomicSerialNumberTSN](#) = 289 ,  
[MouseGenomeInitiativeMGI](#) = 290 ,  
[PubChemCompoundCID](#) = 291 ,  
[ICD11](#) = 292 ,  
[NewYorkUniversityMelanomaClinicalCooperativeGroup](#) = 293 ,  
[MayoClinicNonradiologicalImagesSBSSAnatomicalSurfaceRegionGuide](#) = 294 ,  
[ImageBiomarkerStandardisationInitiative](#) = 295 ,  
[RadiomicsOntology](#) = 296 ,  
[DisplaySystemSOPClass](#) = 297 ,  
[DisplaySystemSOPInstance](#) = 298 ,  
[GeneralAudioWaveformStorage](#) = 299 ,  
[ArterialPulseWaveformStorage](#) = 300 ,  
[RespiratoryWaveformStorage](#) = 301 ,  
[XAXRFGrayscaleSoftcopyPresentationStateStorage](#) = 302 ,  
[GrayscalePlanarMPRVolumetricPresentationStateStorage](#) = 303 ,  
[MPEG4AVCH\\_264HighProfileLevel4\\_2For2DVideo](#) = 304 ,  
[MPEG4AVCH\\_264HighProfileLevel4\\_2For3DVideo](#) = 305 ,  
[MPEG4AVCH\\_264StereoHighProfileLevel4\\_2](#) = 306 ,  
[HEVCH\\_265MainProfileLevel5\\_1](#) = 307 ,  
[HEVCH\\_265Main10ProfileLevel5\\_1](#) = 308 ,  
[HotIronColorPaletteSOPInstance](#) = 309 ,  
[CompositingPlanarMPRVolumetricPresentationStateStorage](#) = 310 ,  
[AdvancedBlendingPresentationStateStorage](#) = 311 ,  
[VolumeRenderingVolumetricPresentationStateStorage](#) = 312 ,  
[SegmentedVolumeRenderingVolumetricPresentationStateStorage](#) = 313 ,  
[MultipleVolumeRenderingVolumetricPresentationStateStorage](#) = 314 ,  
[Null0](#) = 315 ,  
[BreastProjectionXRayImageStorageForPresentation](#) = 316 ,  
[BreastProjectionXRayImageStorageForProcessing](#) = 317 ,  
[IntravascularOpticalCoherenceTomographyImageStorageForPresentation](#) = 318 ,  
[IntravascularOpticalCoherenceTomographyImageStorageForProcessing](#) = 319 ,

[ParametricMapStorage](#) = 320 ,  
[Null1](#) = 321 ,  
[TractographyResultsStorage](#) = 322 ,  
[SurfaceScanMeshStorage](#) = 323 ,  
[SurfaceScanPointCloudStorage](#) = 324 ,  
[WideFieldOphthalmicPhotographyStereographicProjectionImageStorage](#) = 325 ,  
[WideFieldOphthalmicPhotography3DCoordinatesImageStorage](#) = 326 ,  
[OphthalmicOpticalCoherenceTomographyEnFaceImageStorage](#) = 327 ,  
[OphthalmicOpticalCoherenceTomographyBscanVolumeAnalysisStorage](#) = 328 ,  
[LensometryMeasurementsStorage](#) = 329 ,  
[AutorefractometryMeasurementsStorage](#) = 330 ,  
[KeratometryMeasurementsStorage](#) = 331 ,  
[SubjectiveRefractionMeasurementsStorage](#) = 332 ,  
[VisualAcuityMeasurementsStorage](#) = 333 ,  
[SpectaclePrescriptionReportStorage](#) = 334 ,  
[OphthalmicAxialMeasurementsStorage](#) = 335 ,  
[IntraocularLensCalculationsStorage](#) = 336 ,  
[MacularGridThicknessandVolumeReportStorage](#) = 337 ,  
[OphthalmicVisualFieldStaticPerimetryMeasurementsStorage](#) = 338 ,  
[OphthalmicThicknessMapStorage](#) = 339 ,  
[CornealTopographyMapStorage](#) = 340 ,  
[Comprehensive3DSRStorage](#) = 341 ,  
[ExtensibleSRStorage](#) = 342 ,  
[RadiopharmaceuticalRadiationDoseSRStorage](#) = 343 ,  
[ColonCADSRStorage](#) = 344 ,  
[ImplantationPlanSRStorage](#) = 345 ,  
[AcquisitionContextSRStorage](#) = 346 ,  
[SimplifiedAdultEchoSRStorage](#) = 347 ,  
[PatientRadiationDoseSRStorage](#) = 348 ,  
[PlannedImagingAgentAdministrationSRStorage](#) = 349 ,  
[PerformedImagingAgentAdministrationSRStorage](#) = 350 ,  
[ContentAssessmentResultsStorage](#) = 351 ,  
[EncapsulatedSTLStorage](#) = 352 ,  
[EnhancedPETImageStorage](#) = 353 ,  
[BasicStructuredDisplayStorage](#) = 354 ,  
[CTDefinedProcedureProtocolStorage](#) = 355 ,  
[CTPerformedProcedureProtocolStorage](#) = 356 ,  
[ProtocolApprovalStorage](#) = 357 ,  
[ProtocolApprovalInformationModelFIND](#) = 358 ,  
[ProtocolApprovalInformationModelMOVE](#) = 359 ,  
[ProtocolApprovalInformationModelGET](#) = 360 ,  
[RTPhysicianIntentStorage](#) = 361 ,  
[RTSegmentAnnotationStorage](#) = 362 ,  
[DICOSCTImageStorage](#) = 363 ,  
[DICOSDigitalXRayImageStorageForPresentation](#) = 364 ,  
[DICOSDigitalXRayImageStorageForProcessing](#) = 365 ,  
[DICOSThreatDetectionReportStorage](#) = 366 ,  
[DICOS2DAITStorage](#) = 367 ,  
[DICOS3DAITStorage](#) = 368 ,  
[DICOSQuadrupoleResonanceQRStorage](#) = 369 ,  
[EddyCurrentImageStorage](#) = 370 ,  
[EddyCurrentMultiframeImageStorage](#) = 371 ,  
[CompositeInstanceRootRetrieveMOVE](#) = 372 ,  
[CompositeInstanceRootRetrieveGET](#) = 373 ,



CompositeInstanceRetrieveWithoutBulkDataGET = 374 ,  
 DefinedProcedureProtocolInformationModelFIND = 375 ,  
 DefinedProcedureProtocolInformationModelMOVE = 376 ,  
 DefinedProcedureProtocolInformationModelGET = 377 ,  
 UPSFilteredGlobalSubscriptionSOPInstance = 378 ,  
 UnifiedWorklistandProcedureStepServiceClass1 = 379 ,  
 UnifiedProcedureStepPushSOPClass1 = 380 ,  
 UnifiedProcedureStepWatchSOPClass1 = 381 ,  
 UnifiedProcedureStepPullSOPClass1 = 382 ,  
 UnifiedProcedureStepEventSOPClass1 = 383 ,  
 RTBeamsDeliveryInstructionStorage = 384 ,  
 RTConventionalMachineVerification = 385 ,  
 RTIonMachineVerification = 386 ,  
 RTBrachyApplicationSetupDeliveryInstructionStorage = 387 ,  
 HangingProtocolInformationModelGET = 388 ,  
 ColorPaletteStorage = 389 ,  
 ColorPaletteQueryRetrieveInformationModelFIND = 390 ,  
 ColorPaletteQueryRetrieveInformationModelMOVE = 391 ,  
 ColorPaletteQueryRetrieveInformationModelGET = 392 ,  
 GenericImplantTemplateStorage = 393 ,  
 GenericImplantTemplateInformationModelFIND = 394 ,  
 GenericImplantTemplateInformationModelMOVE = 395 ,  
 GenericImplantTemplateInformationModelGET = 396 ,  
 ImplantAssemblyTemplateStorage = 397 ,  
 ImplantAssemblyTemplateInformationModelFIND = 398 ,  
 ImplantAssemblyTemplateInformationModelMOVE = 399 ,  
 ImplantAssemblyTemplateInformationModelGET = 400 ,  
 ImplantTemplateGroupStorage = 401 ,  
 ImplantTemplateGroupInformationModelFIND = 402 ,  
 ImplantTemplateGroupInformationModelMOVE = 403 ,  
 ImplantTemplateGroupInformationModelGET = 404 ,  
 NativeDICOMModel = 405 ,  
 AbstractMultiDimensionalImageModel = 406 ,  
 DICOMContentMappingResource = 407 ,  
 EnhancedMRColorImageStorage = 408 ,  
 UniversalCoordinatedTime = 409 }

- enum TSType {
  - uid\_1\_2\_840\_10008\_1\_1 = 1 ,
  - uid\_1\_2\_840\_10008\_1\_2 = 2 ,
  - uid\_1\_2\_840\_10008\_1\_2\_1 = 3 ,
  - uid\_1\_2\_840\_10008\_1\_2\_1\_99 = 4 ,
  - uid\_1\_2\_840\_10008\_1\_2\_2 = 5 ,
  - uid\_1\_2\_840\_10008\_1\_2\_4\_50 = 6 ,
  - uid\_1\_2\_840\_10008\_1\_2\_4\_51 = 7 ,
  - uid\_1\_2\_840\_10008\_1\_2\_4\_52 = 8 ,
  - uid\_1\_2\_840\_10008\_1\_2\_4\_53 = 9 ,
  - uid\_1\_2\_840\_10008\_1\_2\_4\_54 = 10 ,
  - uid\_1\_2\_840\_10008\_1\_2\_4\_55 = 11 ,
  - uid\_1\_2\_840\_10008\_1\_2\_4\_56 = 12 ,
  - uid\_1\_2\_840\_10008\_1\_2\_4\_57 = 13 ,
  - uid\_1\_2\_840\_10008\_1\_2\_4\_58 = 14 ,
  - uid\_1\_2\_840\_10008\_1\_2\_4\_59 = 15 ,
  - uid\_1\_2\_840\_10008\_1\_2\_4\_60 = 16 ,
  - uid\_1\_2\_840\_10008\_1\_2\_4\_61 = 17 ,

```
uid_1_2_840_10008_1_2_4_62 = 18 ,
uid_1_2_840_10008_1_2_4_63 = 19 ,
uid_1_2_840_10008_1_2_4_64 = 20 ,
uid_1_2_840_10008_1_2_4_65 = 21 ,
uid_1_2_840_10008_1_2_4_66 = 22 ,
uid_1_2_840_10008_1_2_4_70 = 23 ,
uid_1_2_840_10008_1_2_4_80 = 24 ,
uid_1_2_840_10008_1_2_4_81 = 25 ,
uid_1_2_840_10008_1_2_4_90 = 26 ,
uid_1_2_840_10008_1_2_4_91 = 27 ,
uid_1_2_840_10008_1_2_4_92 = 28 ,
uid_1_2_840_10008_1_2_4_93 = 29 ,
uid_1_2_840_10008_1_2_4_94 = 30 ,
uid_1_2_840_10008_1_2_4_95 = 31 ,
uid_1_2_840_10008_1_2_4_100 = 32 ,
uid_1_2_840_10008_1_2_5 = 33 ,
uid_1_2_840_10008_1_2_6_1 = 34 ,
uid_1_2_840_10008_1_2_6_2 = 35 ,
uid_1_2_840_10008_1_3_10 = 36 ,
uid_1_2_840_10008_1_4_1_1 = 37 ,
uid_1_2_840_10008_1_4_1_2 = 38 ,
uid_1_2_840_10008_1_4_1_3 = 39 ,
uid_1_2_840_10008_1_4_1_4 = 40 ,
uid_1_2_840_10008_1_4_1_5 = 41 ,
uid_1_2_840_10008_1_4_1_6 = 42 ,
uid_1_2_840_10008_1_4_1_7 = 43 ,
uid_1_2_840_10008_1_4_1_8 = 44 ,
uid_1_2_840_10008_1_4_1_9 = 45 ,
uid_1_2_840_10008_1_4_1_10 = 46 ,
uid_1_2_840_10008_1_4_1_11 = 47 ,
uid_1_2_840_10008_1_4_1_12 = 48 ,
uid_1_2_840_10008_1_4_1_13 = 49 ,
uid_1_2_840_10008_1_4_1_14 = 50 ,
uid_1_2_840_10008_1_4_1_15 = 51 ,
uid_1_2_840_10008_1_4_1_16 = 52 ,
uid_1_2_840_10008_1_4_1_17 = 53 ,
uid_1_2_840_10008_1_4_1_18 = 54 ,
uid_1_2_840_10008_1_4_2_1 = 55 ,
uid_1_2_840_10008_1_4_2_2 = 56 ,
uid_1_2_840_10008_1_9 = 57 ,
uid_1_2_840_10008_1_20_1 = 58 ,
uid_1_2_840_10008_1_20_1_1 = 59 ,
uid_1_2_840_10008_1_20_2 = 60 ,
uid_1_2_840_10008_1_20_2_1 = 61 ,
uid_1_2_840_10008_1_40 = 62 ,
uid_1_2_840_10008_1_40_1 = 63 ,
uid_1_2_840_10008_1_42 = 64 ,
uid_1_2_840_10008_1_42_1 = 65 ,
uid_1_2_840_10008_2_6_1 = 66 ,
uid_1_2_840_10008_2_16_4 = 67 ,
uid_1_2_840_10008_3_1_1_1 = 68 ,
uid_1_2_840_10008_3_1_2_1_1 = 69 ,
uid_1_2_840_10008_3_1_2_1_4 = 70 ,
uid_1_2_840_10008_3_1_2_2_1 = 71 ,
```

uid\_1\_2\_840\_10008\_3\_1\_2\_3\_1 = 72 ,  
uid\_1\_2\_840\_10008\_3\_1\_2\_3\_2 = 73 ,  
uid\_1\_2\_840\_10008\_3\_1\_2\_3\_3 = 74 ,  
uid\_1\_2\_840\_10008\_3\_1\_2\_3\_4 = 75 ,  
uid\_1\_2\_840\_10008\_3\_1\_2\_3\_5 = 76 ,  
uid\_1\_2\_840\_10008\_3\_1\_2\_5\_1 = 77 ,  
uid\_1\_2\_840\_10008\_3\_1\_2\_5\_4 = 78 ,  
uid\_1\_2\_840\_10008\_3\_1\_2\_5\_5 = 79 ,  
uid\_1\_2\_840\_10008\_3\_1\_2\_6\_1 = 80 ,  
uid\_1\_2\_840\_10008\_4\_2 = 81 ,  
uid\_1\_2\_840\_10008\_5\_1\_1\_1 = 82 ,  
uid\_1\_2\_840\_10008\_5\_1\_1\_2 = 83 ,  
uid\_1\_2\_840\_10008\_5\_1\_1\_4 = 84 ,  
uid\_1\_2\_840\_10008\_5\_1\_1\_4\_1 = 85 ,  
uid\_1\_2\_840\_10008\_5\_1\_1\_4\_2 = 86 ,  
uid\_1\_2\_840\_10008\_5\_1\_1\_9 = 87 ,  
uid\_1\_2\_840\_10008\_5\_1\_1\_9\_1 = 88 ,  
uid\_1\_2\_840\_10008\_5\_1\_1\_14 = 89 ,  
uid\_1\_2\_840\_10008\_5\_1\_1\_15 = 90 ,  
uid\_1\_2\_840\_10008\_5\_1\_1\_16 = 91 ,  
uid\_1\_2\_840\_10008\_5\_1\_1\_16\_376 = 92 ,  
uid\_1\_2\_840\_10008\_5\_1\_1\_17 = 93 ,  
uid\_1\_2\_840\_10008\_5\_1\_1\_17\_376 = 94 ,  
uid\_1\_2\_840\_10008\_5\_1\_1\_18 = 95 ,  
uid\_1\_2\_840\_10008\_5\_1\_1\_18\_1 = 96 ,  
uid\_1\_2\_840\_10008\_5\_1\_1\_22 = 97 ,  
uid\_1\_2\_840\_10008\_5\_1\_1\_23 = 98 ,  
uid\_1\_2\_840\_10008\_5\_1\_1\_24 = 99 ,  
uid\_1\_2\_840\_10008\_5\_1\_1\_24\_1 = 100 ,  
uid\_1\_2\_840\_10008\_5\_1\_1\_25 = 101 ,  
uid\_1\_2\_840\_10008\_5\_1\_1\_26 = 102 ,  
uid\_1\_2\_840\_10008\_5\_1\_1\_27 = 103 ,  
uid\_1\_2\_840\_10008\_5\_1\_1\_29 = 104 ,  
uid\_1\_2\_840\_10008\_5\_1\_1\_30 = 105 ,  
uid\_1\_2\_840\_10008\_5\_1\_1\_31 = 106 ,  
uid\_1\_2\_840\_10008\_5\_1\_1\_32 = 107 ,  
uid\_1\_2\_840\_10008\_5\_1\_1\_33 = 108 ,  
uid\_1\_2\_840\_10008\_5\_1\_4\_1\_1\_1 = 109 ,  
uid\_1\_2\_840\_10008\_5\_1\_4\_1\_1\_1\_1 = 110 ,  
uid\_1\_2\_840\_10008\_5\_1\_4\_1\_1\_1\_1\_1 = 111 ,  
uid\_1\_2\_840\_10008\_5\_1\_4\_1\_1\_1\_2 = 112 ,  
uid\_1\_2\_840\_10008\_5\_1\_4\_1\_1\_1\_2\_1 = 113 ,  
uid\_1\_2\_840\_10008\_5\_1\_4\_1\_1\_1\_3 = 114 ,  
uid\_1\_2\_840\_10008\_5\_1\_4\_1\_1\_1\_3\_1 = 115 ,  
uid\_1\_2\_840\_10008\_5\_1\_4\_1\_1\_2 = 116 ,  
uid\_1\_2\_840\_10008\_5\_1\_4\_1\_1\_2\_1 = 117 ,  
uid\_1\_2\_840\_10008\_5\_1\_4\_1\_1\_3 = 118 ,  
uid\_1\_2\_840\_10008\_5\_1\_4\_1\_1\_3\_1 = 119 ,  
uid\_1\_2\_840\_10008\_5\_1\_4\_1\_1\_4 = 120 ,  
uid\_1\_2\_840\_10008\_5\_1\_4\_1\_1\_4\_1 = 121 ,  
uid\_1\_2\_840\_10008\_5\_1\_4\_1\_1\_4\_2 = 122 ,  
uid\_1\_2\_840\_10008\_5\_1\_4\_1\_1\_5 = 123 ,  
uid\_1\_2\_840\_10008\_5\_1\_4\_1\_1\_6 = 124 ,  
uid\_1\_2\_840\_10008\_5\_1\_4\_1\_1\_6\_1 = 125 ,

uid\_1\_2\_840\_10008\_5\_1\_4\_1\_1\_7 = 126 ,  
uid\_1\_2\_840\_10008\_5\_1\_4\_1\_1\_7\_1 = 127 ,  
uid\_1\_2\_840\_10008\_5\_1\_4\_1\_1\_7\_2 = 128 ,  
uid\_1\_2\_840\_10008\_5\_1\_4\_1\_1\_7\_3 = 129 ,  
uid\_1\_2\_840\_10008\_5\_1\_4\_1\_1\_7\_4 = 130 ,  
uid\_1\_2\_840\_10008\_5\_1\_4\_1\_1\_8 = 131 ,  
uid\_1\_2\_840\_10008\_5\_1\_4\_1\_1\_9 = 132 ,  
uid\_1\_2\_840\_10008\_5\_1\_4\_1\_1\_9\_1 = 133 ,  
uid\_1\_2\_840\_10008\_5\_1\_4\_1\_1\_9\_1\_1 = 134 ,  
uid\_1\_2\_840\_10008\_5\_1\_4\_1\_1\_9\_1\_2 = 135 ,  
uid\_1\_2\_840\_10008\_5\_1\_4\_1\_1\_9\_1\_3 = 136 ,  
uid\_1\_2\_840\_10008\_5\_1\_4\_1\_1\_9\_2\_1 = 137 ,  
uid\_1\_2\_840\_10008\_5\_1\_4\_1\_1\_9\_3\_1 = 138 ,  
uid\_1\_2\_840\_10008\_5\_1\_4\_1\_1\_9\_4\_1 = 139 ,  
uid\_1\_2\_840\_10008\_5\_1\_4\_1\_1\_10 = 140 ,  
uid\_1\_2\_840\_10008\_5\_1\_4\_1\_1\_11 = 141 ,  
uid\_1\_2\_840\_10008\_5\_1\_4\_1\_1\_11\_1 = 142 ,  
uid\_1\_2\_840\_10008\_5\_1\_4\_1\_1\_11\_2 = 143 ,  
uid\_1\_2\_840\_10008\_5\_1\_4\_1\_1\_11\_3 = 144 ,  
uid\_1\_2\_840\_10008\_5\_1\_4\_1\_1\_11\_4 = 145 ,  
uid\_1\_2\_840\_10008\_5\_1\_4\_1\_1\_12\_1 = 146 ,  
uid\_1\_2\_840\_10008\_5\_1\_4\_1\_1\_12\_1\_1 = 147 ,  
uid\_1\_2\_840\_10008\_5\_1\_4\_1\_1\_12\_2 = 148 ,  
uid\_1\_2\_840\_10008\_5\_1\_4\_1\_1\_12\_2\_1 = 149 ,  
uid\_1\_2\_840\_10008\_5\_1\_4\_1\_1\_13\_1\_1 = 150 ,  
uid\_1\_2\_840\_10008\_5\_1\_4\_1\_1\_13\_1\_2 = 151 ,  
uid\_1\_2\_840\_10008\_5\_1\_4\_1\_1\_12\_3 = 152 ,  
uid\_1\_2\_840\_10008\_5\_1\_4\_1\_1\_20 = 153 ,  
uid\_1\_2\_840\_10008\_5\_1\_4\_1\_1\_66 = 154 ,  
uid\_1\_2\_840\_10008\_5\_1\_4\_1\_1\_66\_1 = 155 ,  
uid\_1\_2\_840\_10008\_5\_1\_4\_1\_1\_66\_2 = 156 ,  
uid\_1\_2\_840\_10008\_5\_1\_4\_1\_1\_66\_3 = 157 ,  
uid\_1\_2\_840\_10008\_5\_1\_4\_1\_1\_66\_4 = 158 ,  
uid\_1\_2\_840\_10008\_5\_1\_4\_1\_1\_67 = 159 ,  
uid\_1\_2\_840\_10008\_5\_1\_4\_1\_1\_77\_1 = 160 ,  
uid\_1\_2\_840\_10008\_5\_1\_4\_1\_1\_77\_2 = 161 ,  
uid\_1\_2\_840\_10008\_5\_1\_4\_1\_1\_77\_1\_1 = 162 ,  
uid\_1\_2\_840\_10008\_5\_1\_4\_1\_1\_77\_1\_1\_1 = 163 ,  
uid\_1\_2\_840\_10008\_5\_1\_4\_1\_1\_77\_1\_2 = 164 ,  
uid\_1\_2\_840\_10008\_5\_1\_4\_1\_1\_77\_1\_2\_1 = 165 ,  
uid\_1\_2\_840\_10008\_5\_1\_4\_1\_1\_77\_1\_3 = 166 ,  
uid\_1\_2\_840\_10008\_5\_1\_4\_1\_1\_77\_1\_4 = 167 ,  
uid\_1\_2\_840\_10008\_5\_1\_4\_1\_1\_77\_1\_4\_1 = 168 ,  
uid\_1\_2\_840\_10008\_5\_1\_4\_1\_1\_77\_1\_5\_1 = 169 ,  
uid\_1\_2\_840\_10008\_5\_1\_4\_1\_1\_77\_1\_5\_2 = 170 ,  
uid\_1\_2\_840\_10008\_5\_1\_4\_1\_1\_77\_1\_5\_3 = 171 ,  
uid\_1\_2\_840\_10008\_5\_1\_4\_1\_1\_77\_1\_5\_4 = 172 ,  
uid\_1\_2\_840\_10008\_5\_1\_4\_1\_1\_88\_1 = 173 ,  
uid\_1\_2\_840\_10008\_5\_1\_4\_1\_1\_88\_2 = 174 ,  
uid\_1\_2\_840\_10008\_5\_1\_4\_1\_1\_88\_3 = 175 ,  
uid\_1\_2\_840\_10008\_5\_1\_4\_1\_1\_88\_4 = 176 ,  
uid\_1\_2\_840\_10008\_5\_1\_4\_1\_1\_88\_11 = 177 ,  
uid\_1\_2\_840\_10008\_5\_1\_4\_1\_1\_88\_22 = 178 ,  
uid\_1\_2\_840\_10008\_5\_1\_4\_1\_1\_88\_33 = 179 ,

uid\_1\_2\_840\_10008\_5\_1\_4\_1\_1\_88\_40 = 180 ,  
uid\_1\_2\_840\_10008\_5\_1\_4\_1\_1\_88\_50 = 181 ,  
uid\_1\_2\_840\_10008\_5\_1\_4\_1\_1\_88\_59 = 182 ,  
uid\_1\_2\_840\_10008\_5\_1\_4\_1\_1\_88\_65 = 183 ,  
uid\_1\_2\_840\_10008\_5\_1\_4\_1\_1\_88\_67 = 184 ,  
uid\_1\_2\_840\_10008\_5\_1\_4\_1\_1\_104\_1 = 185 ,  
uid\_1\_2\_840\_10008\_5\_1\_4\_1\_1\_104\_2 = 186 ,  
uid\_1\_2\_840\_10008\_5\_1\_4\_1\_1\_128 = 187 ,  
uid\_1\_2\_840\_10008\_5\_1\_4\_1\_1\_129 = 188 ,  
uid\_1\_2\_840\_10008\_5\_1\_4\_1\_1\_481\_1 = 189 ,  
uid\_1\_2\_840\_10008\_5\_1\_4\_1\_1\_481\_2 = 190 ,  
uid\_1\_2\_840\_10008\_5\_1\_4\_1\_1\_481\_3 = 191 ,  
uid\_1\_2\_840\_10008\_5\_1\_4\_1\_1\_481\_4 = 192 ,  
uid\_1\_2\_840\_10008\_5\_1\_4\_1\_1\_481\_5 = 193 ,  
uid\_1\_2\_840\_10008\_5\_1\_4\_1\_1\_481\_6 = 194 ,  
uid\_1\_2\_840\_10008\_5\_1\_4\_1\_1\_481\_7 = 195 ,  
uid\_1\_2\_840\_10008\_5\_1\_4\_1\_1\_481\_8 = 196 ,  
uid\_1\_2\_840\_10008\_5\_1\_4\_1\_1\_481\_9 = 197 ,  
uid\_1\_2\_840\_10008\_5\_1\_4\_1\_2\_1\_1 = 198 ,  
uid\_1\_2\_840\_10008\_5\_1\_4\_1\_2\_1\_2 = 199 ,  
uid\_1\_2\_840\_10008\_5\_1\_4\_1\_2\_1\_3 = 200 ,  
uid\_1\_2\_840\_10008\_5\_1\_4\_1\_2\_2\_1 = 201 ,  
uid\_1\_2\_840\_10008\_5\_1\_4\_1\_2\_2\_2 = 202 ,  
uid\_1\_2\_840\_10008\_5\_1\_4\_1\_2\_2\_3 = 203 ,  
uid\_1\_2\_840\_10008\_5\_1\_4\_1\_2\_3\_1 = 204 ,  
uid\_1\_2\_840\_10008\_5\_1\_4\_1\_2\_3\_2 = 205 ,  
uid\_1\_2\_840\_10008\_5\_1\_4\_1\_2\_3\_3 = 206 ,  
uid\_1\_2\_840\_10008\_5\_1\_4\_31 = 207 ,  
uid\_1\_2\_840\_10008\_5\_1\_4\_32\_1 = 208 ,  
uid\_1\_2\_840\_10008\_5\_1\_4\_32\_2 = 209 ,  
uid\_1\_2\_840\_10008\_5\_1\_4\_32\_3 = 210 ,  
uid\_1\_2\_840\_10008\_5\_1\_4\_32 = 211 ,  
uid\_1\_2\_840\_10008\_5\_1\_4\_33 = 212 ,  
uid\_1\_2\_840\_10008\_5\_1\_4\_34\_1 = 213 ,  
uid\_1\_2\_840\_10008\_5\_1\_4\_34\_2 = 214 ,  
uid\_1\_2\_840\_10008\_5\_1\_4\_34\_3 = 215 ,  
uid\_1\_2\_840\_10008\_5\_1\_4\_34\_4 = 216 ,  
uid\_1\_2\_840\_10008\_5\_1\_4\_34\_4\_1 = 217 ,  
uid\_1\_2\_840\_10008\_5\_1\_4\_34\_4\_2 = 218 ,  
uid\_1\_2\_840\_10008\_5\_1\_4\_34\_4\_3 = 219 ,  
uid\_1\_2\_840\_10008\_5\_1\_4\_34\_4\_4 = 220 ,  
uid\_1\_2\_840\_10008\_5\_1\_4\_34\_5 = 221 ,  
uid\_1\_2\_840\_10008\_5\_1\_4\_37\_1 = 222 ,  
uid\_1\_2\_840\_10008\_5\_1\_4\_37\_2 = 223 ,  
uid\_1\_2\_840\_10008\_5\_1\_4\_37\_3 = 224 ,  
uid\_1\_2\_840\_10008\_5\_1\_4\_38\_1 = 225 ,  
uid\_1\_2\_840\_10008\_5\_1\_4\_38\_2 = 226 ,  
uid\_1\_2\_840\_10008\_5\_1\_4\_38\_3 = 227 ,  
uid\_1\_2\_840\_10008\_5\_1\_4\_41 = 228 ,  
uid\_1\_2\_840\_10008\_5\_1\_4\_42 = 229 ,  
uid\_1\_2\_840\_10008\_15\_0\_3\_1 = 230 ,  
uid\_1\_2\_840\_10008\_15\_0\_3\_2 = 231 ,  
uid\_1\_2\_840\_10008\_15\_0\_3\_3 = 232 ,  
uid\_1\_2\_840\_10008\_15\_0\_3\_4 = 233 ,

uid\_1\_2\_840\_10008\_15\_0\_3\_5 = 234 ,  
uid\_1\_2\_840\_10008\_15\_0\_3\_6 = 235 ,  
uid\_1\_2\_840\_10008\_15\_0\_3\_7 = 236 ,  
uid\_1\_2\_840\_10008\_15\_0\_3\_8 = 237 ,  
uid\_1\_2\_840\_10008\_15\_0\_3\_9 = 238 ,  
uid\_1\_2\_840\_10008\_15\_0\_3\_10 = 239 ,  
uid\_1\_2\_840\_10008\_15\_0\_3\_11 = 240 ,  
uid\_1\_2\_840\_10008\_15\_0\_3\_12 = 241 ,  
uid\_1\_2\_840\_10008\_15\_0\_3\_13 = 242 ,  
uid\_1\_2\_840\_10008\_15\_0\_3\_14 = 243 ,  
uid\_1\_2\_840\_10008\_15\_0\_3\_15 = 244 ,  
uid\_1\_2\_840\_10008\_15\_0\_3\_16 = 245 ,  
uid\_1\_2\_840\_10008\_15\_0\_3\_17 = 246 ,  
uid\_1\_2\_840\_10008\_15\_0\_3\_18 = 247 ,  
uid\_1\_2\_840\_10008\_15\_0\_3\_19 = 248 ,  
uid\_1\_2\_840\_10008\_15\_0\_3\_20 = 249 ,  
uid\_1\_2\_840\_10008\_15\_0\_3\_21 = 250 ,  
uid\_1\_2\_840\_10008\_15\_0\_3\_22 = 251 ,  
uid\_1\_2\_840\_10008\_15\_0\_3\_23 = 252 ,  
uid\_1\_2\_840\_10008\_15\_0\_3\_24 = 253 ,  
uid\_1\_2\_840\_10008\_15\_0\_3\_25 = 254 ,  
uid\_1\_2\_840\_10008\_15\_0\_3\_26 = 255 ,  
uid\_1\_2\_840\_10008\_15\_0\_3\_27 = 256 ,  
uid\_1\_2\_840\_10008\_15\_0\_3\_28 = 257 ,  
uid\_1\_2\_840\_10008\_15\_0\_3\_29 = 258 ,  
uid\_1\_2\_840\_10008\_15\_0\_3\_30 = 259 ,  
uid\_1\_2\_840\_10008\_15\_0\_3\_31 = 260 ,  
uid\_1\_2\_840\_10008\_15\_0\_4\_1 = 261 ,  
uid\_1\_2\_840\_10008\_15\_0\_4\_2 = 262 ,  
uid\_1\_2\_840\_10008\_15\_0\_4\_3 = 263 ,  
uid\_1\_2\_840\_10008\_15\_0\_4\_4 = 264 ,  
uid\_1\_2\_840\_10008\_15\_0\_4\_5 = 265 ,  
uid\_1\_2\_840\_10008\_15\_0\_4\_6 = 266 ,  
uid\_1\_2\_840\_10008\_15\_0\_4\_7 = 267 ,  
uid\_1\_2\_840\_10008\_15\_0\_4\_8 = 268 ,  
uid\_1\_2\_840\_10008\_5\_1\_4\_1\_1\_77\_1\_6 = 269 ,  
uid\_1\_2\_840\_10008\_5\_1\_4\_1\_1\_6\_2 = 270 ,  
uid\_1\_2\_840\_10008\_5\_1\_4\_1\_1\_66\_5 = 271 ,  
uid\_1\_2\_840\_10008\_5\_1\_4\_1\_1\_13\_1\_3 = 272 ,  
uid\_1\_2\_840\_10008\_5\_1\_4\_1\_1\_2\_2 = 273 ,  
uid\_1\_2\_840\_10008\_5\_1\_4\_1\_1\_4\_4 = 274 ,  
uid\_1\_2\_840\_10008\_5\_1\_4\_1\_1\_128\_1 = 275 ,  
uid\_1\_2\_840\_10008\_1\_2\_4\_101 = 276 ,  
uid\_1\_2\_840\_10008\_1\_2\_4\_102 = 277 ,  
uid\_1\_2\_840\_10008\_1\_2\_4\_103 = 278 ,  
uid\_1\_2\_840\_10008\_1\_5\_2 = 279 ,  
uid\_1\_2\_840\_10008\_1\_5\_3 = 280 ,  
uid\_1\_2\_840\_10008\_1\_5\_4 = 281 ,  
uid\_1\_2\_840\_10008\_1\_5\_5 = 282 ,  
uid\_1\_2\_840\_10008\_1\_5\_6 = 283 ,  
uid\_1\_2\_840\_10008\_1\_5\_7 = 284 ,  
uid\_1\_2\_840\_10008\_1\_5\_8 = 285 ,  
uid\_1\_2\_840\_10008\_1\_20 = 286 ,  
uid\_1\_2\_840\_10008\_2\_16\_5 = 287 ,

uid\_1\_2\_840\_10008\_2\_16\_6 = 288 ,  
uid\_1\_2\_840\_10008\_2\_16\_7 = 289 ,  
uid\_1\_2\_840\_10008\_2\_16\_8 = 290 ,  
uid\_1\_2\_840\_10008\_2\_16\_9 = 291 ,  
uid\_1\_2\_840\_10008\_2\_16\_10 = 292 ,  
uid\_1\_2\_840\_10008\_2\_16\_11 = 293 ,  
uid\_1\_2\_840\_10008\_2\_16\_12 = 294 ,  
uid\_1\_2\_840\_10008\_2\_16\_13 = 295 ,  
uid\_1\_2\_840\_10008\_2\_16\_14 = 296 ,  
uid\_1\_2\_840\_10008\_5\_1\_1\_40 = 297 ,  
uid\_1\_2\_840\_10008\_5\_1\_1\_40\_1 = 298 ,  
uid\_1\_2\_840\_10008\_5\_1\_4\_1\_1\_9\_4\_2 = 299 ,  
uid\_1\_2\_840\_10008\_5\_1\_4\_1\_1\_9\_5\_1 = 300 ,  
uid\_1\_2\_840\_10008\_5\_1\_4\_1\_1\_9\_6\_1 = 301 ,  
uid\_1\_2\_840\_10008\_5\_1\_4\_1\_1\_11\_5 = 302 ,  
uid\_1\_2\_840\_10008\_5\_1\_4\_1\_1\_11\_6 = 303 ,  
uid\_1\_2\_840\_10008\_1\_2\_4\_104 = 304 ,  
uid\_1\_2\_840\_10008\_1\_2\_4\_105 = 305 ,  
uid\_1\_2\_840\_10008\_1\_2\_4\_106 = 306 ,  
uid\_1\_2\_840\_10008\_1\_2\_4\_107 = 307 ,  
uid\_1\_2\_840\_10008\_1\_2\_4\_108 = 308 ,  
uid\_1\_2\_840\_10008\_1\_5\_1 = 309 ,  
uid\_1\_2\_840\_10008\_5\_1\_4\_1\_1\_11\_7 = 310 ,  
uid\_1\_2\_840\_10008\_5\_1\_4\_1\_1\_11\_8 = 311 ,  
uid\_1\_2\_840\_10008\_5\_1\_4\_1\_1\_11\_9 = 312 ,  
uid\_1\_2\_840\_10008\_5\_1\_4\_1\_1\_11\_10 = 313 ,  
uid\_1\_2\_840\_10008\_5\_1\_4\_1\_1\_11\_11 = 314 ,  
uid\_1\_2\_840\_10008\_5\_1\_4\_1\_1\_12\_77 = 315 ,  
uid\_1\_2\_840\_10008\_5\_1\_4\_1\_1\_13\_1\_4 = 316 ,  
uid\_1\_2\_840\_10008\_5\_1\_4\_1\_1\_13\_1\_5 = 317 ,  
uid\_1\_2\_840\_10008\_5\_1\_4\_1\_1\_14\_1 = 318 ,  
uid\_1\_2\_840\_10008\_5\_1\_4\_1\_1\_14\_2 = 319 ,  
uid\_1\_2\_840\_10008\_5\_1\_4\_1\_1\_30 = 320 ,  
uid\_1\_2\_840\_10008\_5\_1\_4\_1\_1\_40 = 321 ,  
uid\_1\_2\_840\_10008\_5\_1\_4\_1\_1\_66\_6 = 322 ,  
uid\_1\_2\_840\_10008\_5\_1\_4\_1\_1\_68\_1 = 323 ,  
uid\_1\_2\_840\_10008\_5\_1\_4\_1\_1\_68\_2 = 324 ,  
uid\_1\_2\_840\_10008\_5\_1\_4\_1\_1\_77\_1\_5\_5 = 325 ,  
uid\_1\_2\_840\_10008\_5\_1\_4\_1\_1\_77\_1\_5\_6 = 326 ,  
uid\_1\_2\_840\_10008\_5\_1\_4\_1\_1\_77\_1\_5\_7 = 327 ,  
uid\_1\_2\_840\_10008\_5\_1\_4\_1\_1\_77\_1\_5\_8 = 328 ,  
uid\_1\_2\_840\_10008\_5\_1\_4\_1\_1\_78\_1 = 329 ,  
uid\_1\_2\_840\_10008\_5\_1\_4\_1\_1\_78\_2 = 330 ,  
uid\_1\_2\_840\_10008\_5\_1\_4\_1\_1\_78\_3 = 331 ,  
uid\_1\_2\_840\_10008\_5\_1\_4\_1\_1\_78\_4 = 332 ,  
uid\_1\_2\_840\_10008\_5\_1\_4\_1\_1\_78\_5 = 333 ,  
uid\_1\_2\_840\_10008\_5\_1\_4\_1\_1\_78\_6 = 334 ,  
uid\_1\_2\_840\_10008\_5\_1\_4\_1\_1\_78\_7 = 335 ,  
uid\_1\_2\_840\_10008\_5\_1\_4\_1\_1\_78\_8 = 336 ,  
uid\_1\_2\_840\_10008\_5\_1\_4\_1\_1\_79\_1 = 337 ,  
uid\_1\_2\_840\_10008\_5\_1\_4\_1\_1\_80\_1 = 338 ,  
uid\_1\_2\_840\_10008\_5\_1\_4\_1\_1\_81\_1 = 339 ,  
uid\_1\_2\_840\_10008\_5\_1\_4\_1\_1\_82\_1 = 340 ,  
uid\_1\_2\_840\_10008\_5\_1\_4\_1\_1\_88\_34 = 341 ,

uid\_1\_2\_840\_10008\_5\_1\_4\_1\_1\_88\_35 = 342 ,  
uid\_1\_2\_840\_10008\_5\_1\_4\_1\_1\_88\_68 = 343 ,  
uid\_1\_2\_840\_10008\_5\_1\_4\_1\_1\_88\_69 = 344 ,  
uid\_1\_2\_840\_10008\_5\_1\_4\_1\_1\_88\_70 = 345 ,  
uid\_1\_2\_840\_10008\_5\_1\_4\_1\_1\_88\_71 = 346 ,  
uid\_1\_2\_840\_10008\_5\_1\_4\_1\_1\_88\_72 = 347 ,  
uid\_1\_2\_840\_10008\_5\_1\_4\_1\_1\_88\_73 = 348 ,  
uid\_1\_2\_840\_10008\_5\_1\_4\_1\_1\_88\_74 = 349 ,  
uid\_1\_2\_840\_10008\_5\_1\_4\_1\_1\_88\_75 = 350 ,  
uid\_1\_2\_840\_10008\_5\_1\_4\_1\_1\_90\_1 = 351 ,  
uid\_1\_2\_840\_10008\_5\_1\_4\_1\_1\_104\_3 = 352 ,  
uid\_1\_2\_840\_10008\_5\_1\_4\_1\_1\_130 = 353 ,  
uid\_1\_2\_840\_10008\_5\_1\_4\_1\_1\_131 = 354 ,  
uid\_1\_2\_840\_10008\_5\_1\_4\_1\_1\_200\_1 = 355 ,  
uid\_1\_2\_840\_10008\_5\_1\_4\_1\_1\_200\_2 = 356 ,  
uid\_1\_2\_840\_10008\_5\_1\_4\_1\_1\_200\_3 = 357 ,  
uid\_1\_2\_840\_10008\_5\_1\_4\_1\_1\_200\_4 = 358 ,  
uid\_1\_2\_840\_10008\_5\_1\_4\_1\_1\_200\_5 = 359 ,  
uid\_1\_2\_840\_10008\_5\_1\_4\_1\_1\_200\_6 = 360 ,  
uid\_1\_2\_840\_10008\_5\_1\_4\_1\_1\_481\_10 = 361 ,  
uid\_1\_2\_840\_10008\_5\_1\_4\_1\_1\_481\_11 = 362 ,  
uid\_1\_2\_840\_10008\_5\_1\_4\_1\_1\_501\_1 = 363 ,  
uid\_1\_2\_840\_10008\_5\_1\_4\_1\_1\_501\_2\_1 = 364 ,  
uid\_1\_2\_840\_10008\_5\_1\_4\_1\_1\_501\_2\_2 = 365 ,  
uid\_1\_2\_840\_10008\_5\_1\_4\_1\_1\_501\_3 = 366 ,  
uid\_1\_2\_840\_10008\_5\_1\_4\_1\_1\_501\_4 = 367 ,  
uid\_1\_2\_840\_10008\_5\_1\_4\_1\_1\_501\_5 = 368 ,  
uid\_1\_2\_840\_10008\_5\_1\_4\_1\_1\_501\_6 = 369 ,  
uid\_1\_2\_840\_10008\_5\_1\_4\_1\_1\_601\_1 = 370 ,  
uid\_1\_2\_840\_10008\_5\_1\_4\_1\_1\_601\_2 = 371 ,  
uid\_1\_2\_840\_10008\_5\_1\_4\_1\_2\_4\_2 = 372 ,  
uid\_1\_2\_840\_10008\_5\_1\_4\_1\_2\_4\_3 = 373 ,  
uid\_1\_2\_840\_10008\_5\_1\_4\_1\_2\_5\_3 = 374 ,  
uid\_1\_2\_840\_10008\_5\_1\_4\_20\_1 = 375 ,  
uid\_1\_2\_840\_10008\_5\_1\_4\_20\_2 = 376 ,  
uid\_1\_2\_840\_10008\_5\_1\_4\_20\_3 = 377 ,  
uid\_1\_2\_840\_10008\_5\_1\_4\_34\_5\_1 = 378 ,  
uid\_1\_2\_840\_10008\_5\_1\_4\_34\_6 = 379 ,  
uid\_1\_2\_840\_10008\_5\_1\_4\_34\_6\_1 = 380 ,  
uid\_1\_2\_840\_10008\_5\_1\_4\_34\_6\_2 = 381 ,  
uid\_1\_2\_840\_10008\_5\_1\_4\_34\_6\_3 = 382 ,  
uid\_1\_2\_840\_10008\_5\_1\_4\_34\_6\_4 = 383 ,  
uid\_1\_2\_840\_10008\_5\_1\_4\_34\_7 = 384 ,  
uid\_1\_2\_840\_10008\_5\_1\_4\_34\_8 = 385 ,  
uid\_1\_2\_840\_10008\_5\_1\_4\_34\_9 = 386 ,  
uid\_1\_2\_840\_10008\_5\_1\_4\_34\_10 = 387 ,  
uid\_1\_2\_840\_10008\_5\_1\_4\_38\_4 = 388 ,  
uid\_1\_2\_840\_10008\_5\_1\_4\_39\_1 = 389 ,  
uid\_1\_2\_840\_10008\_5\_1\_4\_39\_2 = 390 ,  
uid\_1\_2\_840\_10008\_5\_1\_4\_39\_3 = 391 ,  
uid\_1\_2\_840\_10008\_5\_1\_4\_39\_4 = 392 ,  
uid\_1\_2\_840\_10008\_5\_1\_4\_43\_1 = 393 ,  
uid\_1\_2\_840\_10008\_5\_1\_4\_43\_2 = 394 ,  
uid\_1\_2\_840\_10008\_5\_1\_4\_43\_3 = 395 ,



```
uid_1_2_840_10008_5_1_4_43_4 = 396 ,  
uid_1_2_840_10008_5_1_4_44_1 = 397 ,  
uid_1_2_840_10008_5_1_4_44_2 = 398 ,  
uid_1_2_840_10008_5_1_4_44_3 = 399 ,  
uid_1_2_840_10008_5_1_4_44_4 = 400 ,  
uid_1_2_840_10008_5_1_4_45_1 = 401 ,  
uid_1_2_840_10008_5_1_4_45_2 = 402 ,  
uid_1_2_840_10008_5_1_4_45_3 = 403 ,  
uid_1_2_840_10008_5_1_4_45_4 = 404 ,  
uid_1_2_840_10008_7_1_1 = 405 ,  
uid_1_2_840_10008_7_1_2 = 406 ,  
uid_1_2_840_10008_8_1_1 = 407 ,  
uid_1_2_840_10008_5_1_4_1_1_4_3 = 408 ,  
uid_1_2_840_10008_15_1_1 = 409 }
```

## Public Member Functions

- const char \* [GetName](#) () const
- const char \* [GetString](#) () const
- [operator TSType](#) () const
- bool [SetFromUID](#) (const char \*str)

## Static Public Member Functions

- static unsigned int [GetNumberOfTransferSyntaxStrings](#) ()
- static const char \*const \* [GetTransferSyntaxString](#) (unsigned int ts)
- static [TransferSyntaxStringsType](#) [GetTransferSyntaxStrings](#) ()
- static const char \* [GetUIDName](#) (unsigned int ts)
- static const char \* [GetUIDString](#) (unsigned int ts)

### 10.317.1 Detailed Description

all known uids

#### Examples

[GenerateStandardSOPClasses.cxx](#).

### 10.317.2 Member Typedef Documentation

#### 10.317.2.1 TransferSyntaxStringsType

```
typedef const char* const (* gdcm::UIDs::TransferSyntaxStringsType) [2]
```

### 10.317.3 Member Enumeration Documentation

#### 10.317.3.1 TSName

enum `gdcm::UIDs::TSName`

##### Enumerator

VerificationSOPClass
ImplicitVRLittleEndianDefaultTransferSyntaxforDICOM
ExplicitVRLittleEndian
DeflatedExplicitVRLittleEndian
ExplicitVRBigEndian
JPEGBaselineProcess1DefaultTransferSyntaxforLossyJPEG8BitImageCompression
JPEGExtendedProcess24DefaultTransferSyntaxforLossyJPEG12BitImageCompressionProcess4only
JPEGExtendedProcess35Retired
JPEGSpectralSelectionNonHierarchicalProcess68Retired
JPEGSpectralSelectionNonHierarchicalProcess79Retired
JPEGFullProgressionNonHierarchicalProcess1012Retired
JPEGFullProgressionNonHierarchicalProcess1113Retired
JPEGLosslessNonHierarchicalProcess14
JPEGLosslessNonHierarchicalProcess15Retired
JPEGExtendedHierarchicalProcess1618Retired
JPEGExtendedHierarchicalProcess1719Retired
JPEGSpectralSelectionHierarchicalProcess2022Retired
JPEGSpectralSelectionHierarchicalProcess2123Retired
JPEGFullProgressionHierarchicalProcess2426Retired
JPEGFullProgressionHierarchicalProcess2527Retired
JPEGLosslessHierarchicalProcess28Retired
JPEGLosslessHierarchicalProcess29Retired
JPEGLosslessNonHierarchicalFirstOrderPredictionProcess14SelectionValue1DefaultTransferSyntaxforLossless←→ JPEGImageCompression
JPEGLSLosslessImageCompression
JPEGLSLossyNearLosslessImageCompression
JPEG2000ImageCompressionLosslessOnly
JPEG2000ImageCompression
JPEG2000Part2MulticomponentImageCompressionLosslessOnly
JPEG2000Part2MulticomponentImageCompression
JPIPReferenced
JPIPReferencedDeflate
MPEG2MainProfileMainLevel
RLELossless
RFC2557MIMEencapsulation
XMLEncoding

## Enumerator

MediaStorageDirectoryStorage
TalairachBrainAtlasFrameofReference
SPM2T1FrameofReference
SPM2T2FrameofReference
SPM2PDFFrameofReference
SPM2EPIFrameofReference
SPM2FILT1FrameofReference
SPM2PETFrameofReference
SPM2TRANSMFrameofReference
SPM2SPECTFrameofReference
SPM2GRAYFrameofReference
SPM2WHITEFrameofReference
SPM2CSFFrameofReference
SPM2BRAINMASKFrameofReference
SPM2AVG305T1FrameofReference
SPM2AVG152T1FrameofReference
SPM2AVG152T2FrameofReference
SPM2AVG152PDFFrameofReference
SPM2SINGLESUBJT1FrameofReference
ICBM452T1FrameofReference
ICBMSingleSubjectMRIFrameofReference
BasicStudyContentNotificationSOPClassRetired
StorageCommitmentPushModelSOPClass
StorageCommitmentPushModelSOPInstance
StorageCommitmentPullModelSOPClassRetired
StorageCommitmentPullModelSOPInstanceRetired
ProceduralEventLoggingSOPClass
ProceduralEventLoggingSOPInstance
SubstanceAdministrationLoggingSOPClass
SubstanceAdministrationLoggingSOPInstance
DICOMUIDRegistry
DICOMControlledTerminology
DICOMApplicationContextName
DetachedPatientManagementSOPClassRetired
DetachedPatientManagementMetaSOPClassRetired
DetachedVisitManagementSOPClassRetired
DetachedStudyManagementSOPClassRetired
StudyComponentManagementSOPClassRetired
ModalityPerformedProcedureStepSOPClass
ModalityPerformedProcedureStepRetrieveSOPClass
ModalityPerformedProcedureStepNotificationSOPClass
DetachedResultsManagementSOPClassRetired
DetachedResultsManagementMetaSOPClassRetired
DetachedStudyManagementMetaSOPClassRetired

## Enumerator

DetachedInterpretationManagementSOPClassRetired
StorageServiceClass
BasicFilmSessionSOPClass
BasicFilmBoxSOPClass
BasicGrayscaleImageBoxSOPClass
BasicColorImageBoxSOPClass
ReferencedImageBoxSOPClassRetired
BasicGrayscalePrintManagementMetaSOPClass
ReferencedGrayscalePrintManagementMetaSOPClassRetired
PrintJobSOPClass
BasicAnnotationBoxSOPClass
PrinterSOPClass
PrinterConfigurationRetrievalSOPClass
PrinterSOPInstance
PrinterConfigurationRetrievalSOPInstance
BasicColorPrintManagementMetaSOPClass
ReferencedColorPrintManagementMetaSOPClassRetired
VOILUTBoxSOPClass
PresentationLUTSOPClass
ImageOverlayBoxSOPClassRetired
BasicPrintImageOverlayBoxSOPClassRetired
PrintQueueSOPInstanceRetired
PrintQueueManagementSOPClassRetired
StoredPrintStorageSOPClassRetired
HardcopyGrayscaleImageStorageSOPClassRetired
HardcopyColorImageStorageSOPClassRetired
PullPrintRequestSOPClassRetired
PullStoredPrintManagementMetaSOPClassRetired
MediaCreationManagementSOPClassUID
ComputedRadiographyImageStorage
DigitalXRayImageStorageForPresentation
DigitalXRayImageStorageForProcessing
DigitalMammographyXRayImageStorageForPresentation
DigitalMammographyXRayImageStorageForProcessing
DigitalIntraoralXRayImageStorageForPresentation
DigitalIntraoralXRayImageStorageForProcessing
CTImageStorage
EnhancedCTImageStorage
UltrasoundMultiframeImageStorageRetired
UltrasoundMultiframeImageStorage
MRImageStorage
EnhancedMRImageStorage
MRSpectroscopyStorage

## Enumerator

NuclearMedicineImageStorageRetired
UltrasoundImageStorageRetired
UltrasoundImageStorage
SecondaryCaptureImageStorage
MultiframeSingleBitSecondaryCaptureImageStorage
MultiframeGrayscaleByteSecondaryCaptureImageStorage
MultiframeGrayscaleWordSecondaryCaptureImageStorage
MultiframeTrueColorSecondaryCaptureImageStorage
StandaloneOverlayStorageRetired
StandaloneCurveStorageRetired
WaveformStorageTrialRetired
ECG12leadWaveformStorage
GeneralECGWaveformStorage
AmbulatoryECGWaveformStorage
HemodynamicWaveformStorage
CardiacElectrophysiologyWaveformStorage
BasicVoiceAudioWaveformStorage
StandaloneModalityLUTStorageRetired
StandaloneVOILUTStorageRetired
GrayscaleSoftcopyPresentationStateStorageSOPClass
ColorSoftcopyPresentationStateStorageSOPClass
PseudoColorSoftcopyPresentationStateStorageSOPClass
BlendingSoftcopyPresentationStateStorageSOPClass
XRayAngiographicImageStorage
EnhancedXAImageStorage
XRayRadiofluoroscopicImageStorage
EnhancedXRFImageStorage
XRay3DAngiographicImageStorage
XRay3DCraniofacialImageStorage
XRayAngiographicBiPlaneImageStorageRetired
NuclearMedicineImageStorage
RawDataStorage
SpatialRegistrationStorage
SpatialFiducialsStorage
DeformableSpatialRegistrationStorage
SegmentationStorage
RealWorldValueMappingStorage
VImageStorageTrialRetired
VLMultiframeImageStorageTrialRetired
VLEndoscopicImageStorage
VideoEndoscopicImageStorage
VLMicroscopicImageStorage
VideoMicroscopicImageStorage

## Enumerator

VLSlideCoordinatesMicroscopicImageStorage
VLPhotographicImageStorage
VideoPhotographicImageStorage
OphthalmicPhotography8BitImageStorage
OphthalmicPhotography16BitImageStorage
StereometricRelationshipStorage
OphthalmicTomographyImageStorage
TextSRStorageTrialRetired
AudioSRStorageTrialRetired
DetailSRStorageTrialRetired
ComprehensiveSRStorageTrialRetired
BasicTextSRStorage
EnhancedSRStorage
ComprehensiveSRStorage
ProcedureLogStorage
MammographyCADSRStorage
KeyObjectSelectionDocumentStorage
ChestCADSRStorage
XRayRadiationDoseSRStorage
EncapsulatedPDFStorage
EncapsulatedCDASStorage
PositronEmissionTomographyImageStorage
StandalonePETCurveStorageRetired
RTImageStorage
RTDoseStorage
RTStructureSetStorage
RTBeamsTreatmentRecordStorage
RTPlanStorage
RTBrachyTreatmentRecordStorage
RTTreatmentSummaryRecordStorage
RTIonPlanStorage
RTIonBeamsTreatmentRecordStorage
PatientRootQueryRetrieveInformationModelFIND
PatientRootQueryRetrieveInformationModelMOVE
PatientRootQueryRetrieveInformationModelGET
StudyRootQueryRetrieveInformationModelFIND
StudyRootQueryRetrieveInformationModelMOVE
StudyRootQueryRetrieveInformationModelGET
PatientStudyOnlyQueryRetrieveInformationModelFINDRetired
PatientStudyOnlyQueryRetrieveInformationModelMOVERetired
PatientStudyOnlyQueryRetrieveInformationModelGETRetired
ModalityWorklistInformationModelFIND
GeneralPurposeWorklistInformationModelFIND

## Enumerator

GeneralPurposeScheduledProcedureStepSOPClass
GeneralPurposePerformedProcedureStepSOPClass
GeneralPurposeWorklistManagementMetaSOPClass
InstanceAvailabilityNotificationSOPClass
RTBeamsDeliveryInstructionStorageSupplement74FrozenDraft
RTConventionalMachineVerificationSupplement74FrozenDraft
RTIonMachineVerificationSupplement74FrozenDraft
UnifiedWorklistandProcedureStepServiceClass
UnifiedProcedureStepPushSOPClass
UnifiedProcedureStepWatchSOPClass
UnifiedProcedureStepPullSOPClass
UnifiedProcedureStepEventSOPClass
UnifiedWorklistandProcedureStepSOPInstance
GeneralRelevantPatientInformationQuery
BreastImagingRelevantPatientInformationQuery
CardiacRelevantPatientInformationQuery
HangingProtocolStorage
HangingProtocolInformationModelFIND
HangingProtocolInformationModelMOVE
ProductCharacteristicsQuerySOPClass
SubstanceApprovalQuerySOPClass
dicomDeviceName
dicomDescription
dicomManufacturer
dicomManufacturerModelName
dicomSoftwareVersion
dicomVendorData
dicomAETitle
dicomNetworkConnectionReference
dicomApplicationCluster
dicomAssociationInitiator
dicomAssociationAcceptor
dicomHostname
dicomPort
dicomSOPClass
dicomTransferRole
dicomTransferSyntax
dicomPrimaryDeviceType
dicomRelatedDeviceReference
dicomPreferredCalledAETitle
dicomTLSCyphersuite
dicomAuthorizedNodeCertificateReference
dicomThisNodeCertificateReference
dicomInstalled

## Enumerator

dicomStationName
dicomDeviceSerialNumber
dicomInstitutionName
dicomInstitutionAddress
dicomInstitutionDepartmentName
dicomIssuerOfPatientID
dicomPreferredCallingAETitle
dicomSupportedCharacterSet
dicomConfigurationRoot
dicomDevicesRoot
dicomUniqueAETitlesRegistryRoot
dicomDevice
dicomNetworkAE
dicomNetworkConnection
dicomUniqueAETitle
dicomTransferCapability
VLWholeSlideMicroscopyImageStorage
EnhancedUSVolumeStorage
SurfaceSegmentationStorage
BreastTomosynthesisImageStorage
LegacyConvertedEnhancedCTImageStorage
LegacyConvertedEnhancedMRIImageStorage
LegacyConvertedEnhancedPETImageStorage
MPEG2MainProfileHighLevel
MPEG4AVCH_264HighProfileLevel4_1
MPEG4AVCH_264BDcompatibleHighProfileLevel4_1
PETColorPaletteSOPInstance
HotMetalBlueColorPaletteSOPInstance
PET20StepColorPaletteSOPInstance
SpringColorPaletteSOPInstance
SummerColorPaletteSOPInstance
FallColorPaletteSOPInstance
WinterColorPaletteSOPInstance
Papyrus3ImplicitVRLittleEndian
AdultMouseAnatomyOntology
UberonOntology
IntegratedTaxonomicInformationSystemITISTaxonomicSerialNumberTSN
MouseGenomeInitiativeMGI
PubChemCompoundCID
ICD11
NewYorkUniversityMelanomaClinicalCooperativeGroup
MayoClinicNonradiologicalImagesSBSAnatomicalSurfaceRegionGuide
ImageBiomarkerStandardisationInitiative
RadiomicsOntology



## Enumerator

DisplaySystemSOPClass
DisplaySystemSOPInstance
GeneralAudioWaveformStorage
ArterialPulseWaveformStorage
RespiratoryWaveformStorage
XAXRFGrayscaleSoftcopyPresentationStateStorage
GrayscalePlanarMPRVolumetricPresentationStateStorage
MPEG4AVCH_264HighProfileLevel4_2For2DVideo
MPEG4AVCH_264HighProfileLevel4_2For3DVideo
MPEG4AVCH_264StereoHighProfileLevel4_2
HEVCH_265MainProfileLevel5_1
HEVCH_265Main10ProfileLevel5_1
HotIronColorPaletteSOPInstance
CompositingPlanarMPRVolumetricPresentationStateStorage
AdvancedBlendingPresentationStateStorage
VolumeRenderingVolumetricPresentationStateStorage
SegmentedVolumeRenderingVolumetricPresentationStateStorage
MultipleVolumeRenderingVolumetricPresentationStateStorage
Null0
BreastProjectionXRayImageStorageForPresentation
BreastProjectionXRayImageStorageForProcessing
IntravascularOpticalCoherenceTomographyImageStorageForPresentation
IntravascularOpticalCoherenceTomographyImageStorageForProcessing
ParametricMapStorage
Null1
TractographyResultsStorage
SurfaceScanMeshStorage
SurfaceScanPointCloudStorage
WideFieldOphthalmicPhotographyStereographicProjectionImageStorage
WideFieldOphthalmicPhotography3DCoordinatesImageStorage
OphthalmicOpticalCoherenceTomographyEnFaceImageStorage
OphthalmicOpticalCoherenceTomographyBscanVolumeAnalysisStorage
LensometryMeasurementsStorage
AutorefractionMeasurementsStorage
KeratometryMeasurementsStorage
SubjectiveRefractionMeasurementsStorage
VisualAcuityMeasurementsStorage
SpectaclePrescriptionReportStorage
OphthalmicAxialMeasurementsStorage
IntraocularLensCalculationsStorage
MacularGridThicknessandVolumeReportStorage
OphthalmicVisualFieldStaticPerimetryMeasurementsStorage
OphthalmicThicknessMapStorage

## Enumerator

CornealTopographyMapStorage
Comprehensive3DSRStorage
ExtensibleSRStorage
RadiopharmaceuticalRadiationDoseSRStorage
ColonCADSRStorage
ImplantationPlanSRStorage
AcquisitionContextSRStorage
SimplifiedAdultEchoSRStorage
PatientRadiationDoseSRStorage
PlannedImagingAgentAdministrationSRStorage
PerformedImagingAgentAdministrationSRStorage
ContentAssessmentResultsStorage
EncapsulatedSTLStorage
EnhancedPETImageStorage
BasicStructuredDisplayStorage
CTDefinedProcedureProtocolStorage
CTPerformedProcedureProtocolStorage
ProtocolApprovalStorage
ProtocolApprovalInformationModelFIND
ProtocolApprovalInformationModelMOVE
ProtocolApprovalInformationModelGET
RTPhysicianIntentStorage
RTSegmentAnnotationStorage
DICOSCTImageStorage
DICOSDigitalXRayImageStorageForPresentation
DICOSDigitalXRayImageStorageForProcessing
DICOSThreatDetectionReportStorage
DICOS2DAITStorage
DICOS3DAITStorage
DICOSQuadrupoleResonanceQRStorage
EddyCurrentImageStorage
EddyCurrentMultiframeImageStorage
CompositeInstanceRootRetrieveMOVE
CompositeInstanceRootRetrieveGET
CompositeInstanceRetrieveWithoutBulkDataGET
DefinedProcedureProtocolInformationModelFIND
DefinedProcedureProtocolInformationModelMOVE
DefinedProcedureProtocolInformationModelGET
UPSFilteredGlobalSubscriptionSOPInstance
UnifiedWorklistandProcedureStepServiceClass1
UnifiedProcedureStepPushSOPClass1
UnifiedProcedureStepWatchSOPClass1
UnifiedProcedureStepPullSOPClass1

## Enumerator

UnifiedProcedureStepEventSOPClass1	
RTBeamsDeliveryInstructionStorage	
RTConventionalMachineVerification	
RTIonMachineVerification	
RTBrachyApplicationSetupDeliveryInstructionStorage	
HangingProtocolInformationModelGET	
ColorPaletteStorage	
ColorPaletteQueryRetrieveInformationModelFIND	
ColorPaletteQueryRetrieveInformationModelMOVE	
ColorPaletteQueryRetrieveInformationModelGET	
GenericImplantTemplateStorage	
GenericImplantTemplateInformationModelFIND	
GenericImplantTemplateInformationModelMOVE	
GenericImplantTemplateInformationModelGET	
ImplantAssemblyTemplateStorage	
ImplantAssemblyTemplateInformationModelFIND	
ImplantAssemblyTemplateInformationModelMOVE	
ImplantAssemblyTemplateInformationModelGET	
ImplantTemplateGroupStorage	
ImplantTemplateGroupInformationModelFIND	
ImplantTemplateGroupInformationModelMOVE	
ImplantTemplateGroupInformationModelGET	
NativeDICOMModel	
AbstractMultiDimensionalImageModel	
DICOMContentMappingResource	
EnhancedMRColorImageStorage	
UniversalCoordinatedTime	

## 10.317.3.2 TSType

```
enum gdcM::UIDs::TSType
```

## Enumerator

uid_1_2_840_10008_1_1	
uid_1_2_840_10008_1_2	
uid_1_2_840_10008_1_2_1	
uid_1_2_840_10008_1_2_1_99	
uid_1_2_840_10008_1_2_2	
uid_1_2_840_10008_1_2_4_50	
uid_1_2_840_10008_1_2_4_51	

## Enumerator

uid_1_2_840_10008_1_2_4_52	
uid_1_2_840_10008_1_2_4_53	
uid_1_2_840_10008_1_2_4_54	
uid_1_2_840_10008_1_2_4_55	
uid_1_2_840_10008_1_2_4_56	
uid_1_2_840_10008_1_2_4_57	
uid_1_2_840_10008_1_2_4_58	
uid_1_2_840_10008_1_2_4_59	
uid_1_2_840_10008_1_2_4_60	
uid_1_2_840_10008_1_2_4_61	
uid_1_2_840_10008_1_2_4_62	
uid_1_2_840_10008_1_2_4_63	
uid_1_2_840_10008_1_2_4_64	
uid_1_2_840_10008_1_2_4_65	
uid_1_2_840_10008_1_2_4_66	
uid_1_2_840_10008_1_2_4_70	
uid_1_2_840_10008_1_2_4_80	
uid_1_2_840_10008_1_2_4_81	
uid_1_2_840_10008_1_2_4_90	
uid_1_2_840_10008_1_2_4_91	
uid_1_2_840_10008_1_2_4_92	
uid_1_2_840_10008_1_2_4_93	
uid_1_2_840_10008_1_2_4_94	
uid_1_2_840_10008_1_2_4_95	
uid_1_2_840_10008_1_2_4_100	
uid_1_2_840_10008_1_2_5	
uid_1_2_840_10008_1_2_6_1	
uid_1_2_840_10008_1_2_6_2	
uid_1_2_840_10008_1_3_10	
uid_1_2_840_10008_1_4_1_1	
uid_1_2_840_10008_1_4_1_2	
uid_1_2_840_10008_1_4_1_3	
uid_1_2_840_10008_1_4_1_4	
uid_1_2_840_10008_1_4_1_5	
uid_1_2_840_10008_1_4_1_6	
uid_1_2_840_10008_1_4_1_7	
uid_1_2_840_10008_1_4_1_8	
uid_1_2_840_10008_1_4_1_9	
uid_1_2_840_10008_1_4_1_10	
uid_1_2_840_10008_1_4_1_11	
uid_1_2_840_10008_1_4_1_12	
uid_1_2_840_10008_1_4_1_13	
uid_1_2_840_10008_1_4_1_14	
uid_1_2_840_10008_1_4_1_15	
uid_1_2_840_10008_1_4_1_16	
uid_1_2_840_10008_1_4_1_17	

## Enumerator

uid_1_2_840_10008_1_4_1_18	
uid_1_2_840_10008_1_4_2_1	
uid_1_2_840_10008_1_4_2_2	
uid_1_2_840_10008_1_9	
uid_1_2_840_10008_1_20_1	
uid_1_2_840_10008_1_20_1_1	
uid_1_2_840_10008_1_20_2	
uid_1_2_840_10008_1_20_2_1	
uid_1_2_840_10008_1_40	
uid_1_2_840_10008_1_40_1	
uid_1_2_840_10008_1_42	
uid_1_2_840_10008_1_42_1	
uid_1_2_840_10008_2_6_1	
uid_1_2_840_10008_2_16_4	
uid_1_2_840_10008_3_1_1_1	
uid_1_2_840_10008_3_1_2_1_1	
uid_1_2_840_10008_3_1_2_1_4	
uid_1_2_840_10008_3_1_2_2_1	
uid_1_2_840_10008_3_1_2_3_1	
uid_1_2_840_10008_3_1_2_3_2	
uid_1_2_840_10008_3_1_2_3_3	
uid_1_2_840_10008_3_1_2_3_4	
uid_1_2_840_10008_3_1_2_3_5	
uid_1_2_840_10008_3_1_2_5_1	
uid_1_2_840_10008_3_1_2_5_4	
uid_1_2_840_10008_3_1_2_5_5	
uid_1_2_840_10008_3_1_2_6_1	
uid_1_2_840_10008_4_2	
uid_1_2_840_10008_5_1_1_1	
uid_1_2_840_10008_5_1_1_2	
uid_1_2_840_10008_5_1_1_4	
uid_1_2_840_10008_5_1_1_4_1	
uid_1_2_840_10008_5_1_1_4_2	
uid_1_2_840_10008_5_1_1_9	
uid_1_2_840_10008_5_1_1_9_1	
uid_1_2_840_10008_5_1_1_14	
uid_1_2_840_10008_5_1_1_15	
uid_1_2_840_10008_5_1_1_16	
uid_1_2_840_10008_5_1_1_16_376	
uid_1_2_840_10008_5_1_1_17	
uid_1_2_840_10008_5_1_1_17_376	
uid_1_2_840_10008_5_1_1_18	
uid_1_2_840_10008_5_1_1_18_1	
uid_1_2_840_10008_5_1_1_22	
uid_1_2_840_10008_5_1_1_23	
uid_1_2_840_10008_5_1_1_24	

## Enumerator

uid_1_2_840_10008_5_1_1_24_1	
uid_1_2_840_10008_5_1_1_25	
uid_1_2_840_10008_5_1_1_26	
uid_1_2_840_10008_5_1_1_27	
uid_1_2_840_10008_5_1_1_29	
uid_1_2_840_10008_5_1_1_30	
uid_1_2_840_10008_5_1_1_31	
uid_1_2_840_10008_5_1_1_32	
uid_1_2_840_10008_5_1_1_33	
uid_1_2_840_10008_5_1_4_1_1_1	
uid_1_2_840_10008_5_1_4_1_1_1_1	
uid_1_2_840_10008_5_1_4_1_1_1_1_1	
uid_1_2_840_10008_5_1_4_1_1_1_2	
uid_1_2_840_10008_5_1_4_1_1_1_2_1	
uid_1_2_840_10008_5_1_4_1_1_1_3	
uid_1_2_840_10008_5_1_4_1_1_1_3_1	
uid_1_2_840_10008_5_1_4_1_1_2	
uid_1_2_840_10008_5_1_4_1_1_2_1	
uid_1_2_840_10008_5_1_4_1_1_3	
uid_1_2_840_10008_5_1_4_1_1_3_1	
uid_1_2_840_10008_5_1_4_1_1_4	
uid_1_2_840_10008_5_1_4_1_1_4_1	
uid_1_2_840_10008_5_1_4_1_1_4_2	
uid_1_2_840_10008_5_1_4_1_1_5	
uid_1_2_840_10008_5_1_4_1_1_6	
uid_1_2_840_10008_5_1_4_1_1_6_1	
uid_1_2_840_10008_5_1_4_1_1_7	
uid_1_2_840_10008_5_1_4_1_1_7_1	
uid_1_2_840_10008_5_1_4_1_1_7_2	
uid_1_2_840_10008_5_1_4_1_1_7_3	
uid_1_2_840_10008_5_1_4_1_1_7_4	
uid_1_2_840_10008_5_1_4_1_1_8	
uid_1_2_840_10008_5_1_4_1_1_9	
uid_1_2_840_10008_5_1_4_1_1_9_1	
uid_1_2_840_10008_5_1_4_1_1_9_1_1	
uid_1_2_840_10008_5_1_4_1_1_9_1_2	
uid_1_2_840_10008_5_1_4_1_1_9_1_3	
uid_1_2_840_10008_5_1_4_1_1_9_2_1	
uid_1_2_840_10008_5_1_4_1_1_9_3_1	
uid_1_2_840_10008_5_1_4_1_1_9_4_1	
uid_1_2_840_10008_5_1_4_1_1_10	
uid_1_2_840_10008_5_1_4_1_1_11	
uid_1_2_840_10008_5_1_4_1_1_11_1	
uid_1_2_840_10008_5_1_4_1_1_11_2	
uid_1_2_840_10008_5_1_4_1_1_11_3	
uid_1_2_840_10008_5_1_4_1_1_11_4	

## Enumerator

uid_1_2_840_10008_5_1_4_1_1_12_1	
uid_1_2_840_10008_5_1_4_1_1_12_1_1	
uid_1_2_840_10008_5_1_4_1_1_12_2	
uid_1_2_840_10008_5_1_4_1_1_12_2_1	
uid_1_2_840_10008_5_1_4_1_1_13_1_1	
uid_1_2_840_10008_5_1_4_1_1_13_1_2	
uid_1_2_840_10008_5_1_4_1_1_12_3	
uid_1_2_840_10008_5_1_4_1_1_20	
uid_1_2_840_10008_5_1_4_1_1_66	
uid_1_2_840_10008_5_1_4_1_1_66_1	
uid_1_2_840_10008_5_1_4_1_1_66_2	
uid_1_2_840_10008_5_1_4_1_1_66_3	
uid_1_2_840_10008_5_1_4_1_1_66_4	
uid_1_2_840_10008_5_1_4_1_1_67	
uid_1_2_840_10008_5_1_4_1_1_77_1	
uid_1_2_840_10008_5_1_4_1_1_77_2	
uid_1_2_840_10008_5_1_4_1_1_77_1_1	
uid_1_2_840_10008_5_1_4_1_1_77_1_1↵ _1	
uid_1_2_840_10008_5_1_4_1_1_77_1_2	
uid_1_2_840_10008_5_1_4_1_1_77_1_2↵ _1	
uid_1_2_840_10008_5_1_4_1_1_77_1_3	
uid_1_2_840_10008_5_1_4_1_1_77_1_4	
uid_1_2_840_10008_5_1_4_1_1_77_1_4↵ _1	
uid_1_2_840_10008_5_1_4_1_1_77_1_5↵ _1	
uid_1_2_840_10008_5_1_4_1_1_77_1_5↵ _2	
uid_1_2_840_10008_5_1_4_1_1_77_1_5↵ _3	
uid_1_2_840_10008_5_1_4_1_1_77_1_5↵ _4	
uid_1_2_840_10008_5_1_4_1_1_88_1	
uid_1_2_840_10008_5_1_4_1_1_88_2	
uid_1_2_840_10008_5_1_4_1_1_88_3	
uid_1_2_840_10008_5_1_4_1_1_88_4	
uid_1_2_840_10008_5_1_4_1_1_88_11	
uid_1_2_840_10008_5_1_4_1_1_88_22	
uid_1_2_840_10008_5_1_4_1_1_88_33	
uid_1_2_840_10008_5_1_4_1_1_88_40	
uid_1_2_840_10008_5_1_4_1_1_88_50	
uid_1_2_840_10008_5_1_4_1_1_88_59	
uid_1_2_840_10008_5_1_4_1_1_88_65	
uid_1_2_840_10008_5_1_4_1_1_88_67	
uid_1_2_840_10008_5_1_4_1_1_104_1	

## Enumerator

uid_1_2_840_10008_5_1_4_1_1_104_2	
uid_1_2_840_10008_5_1_4_1_1_128	
uid_1_2_840_10008_5_1_4_1_1_129	
uid_1_2_840_10008_5_1_4_1_1_481_1	
uid_1_2_840_10008_5_1_4_1_1_481_2	
uid_1_2_840_10008_5_1_4_1_1_481_3	
uid_1_2_840_10008_5_1_4_1_1_481_4	
uid_1_2_840_10008_5_1_4_1_1_481_5	
uid_1_2_840_10008_5_1_4_1_1_481_6	
uid_1_2_840_10008_5_1_4_1_1_481_7	
uid_1_2_840_10008_5_1_4_1_1_481_8	
uid_1_2_840_10008_5_1_4_1_1_481_9	
uid_1_2_840_10008_5_1_4_1_2_1_1	
uid_1_2_840_10008_5_1_4_1_2_1_2	
uid_1_2_840_10008_5_1_4_1_2_1_3	
uid_1_2_840_10008_5_1_4_1_2_2_1	
uid_1_2_840_10008_5_1_4_1_2_2_2	
uid_1_2_840_10008_5_1_4_1_2_2_3	
uid_1_2_840_10008_5_1_4_1_2_3_1	
uid_1_2_840_10008_5_1_4_1_2_3_2	
uid_1_2_840_10008_5_1_4_1_2_3_3	
uid_1_2_840_10008_5_1_4_31	
uid_1_2_840_10008_5_1_4_32_1	
uid_1_2_840_10008_5_1_4_32_2	
uid_1_2_840_10008_5_1_4_32_3	
uid_1_2_840_10008_5_1_4_32	
uid_1_2_840_10008_5_1_4_33	
uid_1_2_840_10008_5_1_4_34_1	
uid_1_2_840_10008_5_1_4_34_2	
uid_1_2_840_10008_5_1_4_34_3	
uid_1_2_840_10008_5_1_4_34_4	
uid_1_2_840_10008_5_1_4_34_4_1	
uid_1_2_840_10008_5_1_4_34_4_2	
uid_1_2_840_10008_5_1_4_34_4_3	
uid_1_2_840_10008_5_1_4_34_4_4	
uid_1_2_840_10008_5_1_4_34_5	
uid_1_2_840_10008_5_1_4_37_1	
uid_1_2_840_10008_5_1_4_37_2	
uid_1_2_840_10008_5_1_4_37_3	
uid_1_2_840_10008_5_1_4_38_1	
uid_1_2_840_10008_5_1_4_38_2	
uid_1_2_840_10008_5_1_4_38_3	
uid_1_2_840_10008_5_1_4_41	
uid_1_2_840_10008_5_1_4_42	
uid_1_2_840_10008_15_0_3_1	
uid_1_2_840_10008_15_0_3_2	



## Enumerator

uid_1_2_840_10008_15_0_3_3	
uid_1_2_840_10008_15_0_3_4	
uid_1_2_840_10008_15_0_3_5	
uid_1_2_840_10008_15_0_3_6	
uid_1_2_840_10008_15_0_3_7	
uid_1_2_840_10008_15_0_3_8	
uid_1_2_840_10008_15_0_3_9	
uid_1_2_840_10008_15_0_3_10	
uid_1_2_840_10008_15_0_3_11	
uid_1_2_840_10008_15_0_3_12	
uid_1_2_840_10008_15_0_3_13	
uid_1_2_840_10008_15_0_3_14	
uid_1_2_840_10008_15_0_3_15	
uid_1_2_840_10008_15_0_3_16	
uid_1_2_840_10008_15_0_3_17	
uid_1_2_840_10008_15_0_3_18	
uid_1_2_840_10008_15_0_3_19	
uid_1_2_840_10008_15_0_3_20	
uid_1_2_840_10008_15_0_3_21	
uid_1_2_840_10008_15_0_3_22	
uid_1_2_840_10008_15_0_3_23	
uid_1_2_840_10008_15_0_3_24	
uid_1_2_840_10008_15_0_3_25	
uid_1_2_840_10008_15_0_3_26	
uid_1_2_840_10008_15_0_3_27	
uid_1_2_840_10008_15_0_3_28	
uid_1_2_840_10008_15_0_3_29	
uid_1_2_840_10008_15_0_3_30	
uid_1_2_840_10008_15_0_3_31	
uid_1_2_840_10008_15_0_4_1	
uid_1_2_840_10008_15_0_4_2	
uid_1_2_840_10008_15_0_4_3	
uid_1_2_840_10008_15_0_4_4	
uid_1_2_840_10008_15_0_4_5	
uid_1_2_840_10008_15_0_4_6	
uid_1_2_840_10008_15_0_4_7	
uid_1_2_840_10008_15_0_4_8	
uid_1_2_840_10008_5_1_4_1_1_77_1_6	
uid_1_2_840_10008_5_1_4_1_1_6_2	
uid_1_2_840_10008_5_1_4_1_1_66_5	
uid_1_2_840_10008_5_1_4_1_1_13_1_3	
uid_1_2_840_10008_5_1_4_1_1_2_2	
uid_1_2_840_10008_5_1_4_1_1_4_4	
uid_1_2_840_10008_5_1_4_1_1_128_1	
uid_1_2_840_10008_1_2_4_101	
uid_1_2_840_10008_1_2_4_102	

## Enumerator

uid_1_2_840_10008_1_2_4_103	
uid_1_2_840_10008_1_5_2	
uid_1_2_840_10008_1_5_3	
uid_1_2_840_10008_1_5_4	
uid_1_2_840_10008_1_5_5	
uid_1_2_840_10008_1_5_6	
uid_1_2_840_10008_1_5_7	
uid_1_2_840_10008_1_5_8	
uid_1_2_840_10008_1_20	
uid_1_2_840_10008_2_16_5	
uid_1_2_840_10008_2_16_6	
uid_1_2_840_10008_2_16_7	
uid_1_2_840_10008_2_16_8	
uid_1_2_840_10008_2_16_9	
uid_1_2_840_10008_2_16_10	
uid_1_2_840_10008_2_16_11	
uid_1_2_840_10008_2_16_12	
uid_1_2_840_10008_2_16_13	
uid_1_2_840_10008_2_16_14	
uid_1_2_840_10008_5_1_1_40	
uid_1_2_840_10008_5_1_1_40_1	
uid_1_2_840_10008_5_1_4_1_1_9_4_2	
uid_1_2_840_10008_5_1_4_1_1_9_5_1	
uid_1_2_840_10008_5_1_4_1_1_9_6_1	
uid_1_2_840_10008_5_1_4_1_1_11_5	
uid_1_2_840_10008_5_1_4_1_1_11_6	
uid_1_2_840_10008_1_2_4_104	
uid_1_2_840_10008_1_2_4_105	
uid_1_2_840_10008_1_2_4_106	
uid_1_2_840_10008_1_2_4_107	
uid_1_2_840_10008_1_2_4_108	
uid_1_2_840_10008_1_5_1	
uid_1_2_840_10008_5_1_4_1_1_11_7	
uid_1_2_840_10008_5_1_4_1_1_11_8	
uid_1_2_840_10008_5_1_4_1_1_11_9	
uid_1_2_840_10008_5_1_4_1_1_11_10	
uid_1_2_840_10008_5_1_4_1_1_11_11	
uid_1_2_840_10008_5_1_4_1_1_12_77	
uid_1_2_840_10008_5_1_4_1_1_13_1_4	
uid_1_2_840_10008_5_1_4_1_1_13_1_5	
uid_1_2_840_10008_5_1_4_1_1_14_1	
uid_1_2_840_10008_5_1_4_1_1_14_2	
uid_1_2_840_10008_5_1_4_1_1_30	
uid_1_2_840_10008_5_1_4_1_1_40	
uid_1_2_840_10008_5_1_4_1_1_66_6	
uid_1_2_840_10008_5_1_4_1_1_68_1	

## Enumerator

uid_1_2_840_10008_5_1_4_1_1_68_2	
uid_1_2_840_10008_5_1_4_1_1_77_1_5↔ _5	
uid_1_2_840_10008_5_1_4_1_1_77_1_5↔ _6	
uid_1_2_840_10008_5_1_4_1_1_77_1_5↔ _7	
uid_1_2_840_10008_5_1_4_1_1_77_1_5↔ _8	
uid_1_2_840_10008_5_1_4_1_1_78_1	
uid_1_2_840_10008_5_1_4_1_1_78_2	
uid_1_2_840_10008_5_1_4_1_1_78_3	
uid_1_2_840_10008_5_1_4_1_1_78_4	
uid_1_2_840_10008_5_1_4_1_1_78_5	
uid_1_2_840_10008_5_1_4_1_1_78_6	
uid_1_2_840_10008_5_1_4_1_1_78_7	
uid_1_2_840_10008_5_1_4_1_1_78_8	
uid_1_2_840_10008_5_1_4_1_1_79_1	
uid_1_2_840_10008_5_1_4_1_1_80_1	
uid_1_2_840_10008_5_1_4_1_1_81_1	
uid_1_2_840_10008_5_1_4_1_1_82_1	
uid_1_2_840_10008_5_1_4_1_1_88_34	
uid_1_2_840_10008_5_1_4_1_1_88_35	
uid_1_2_840_10008_5_1_4_1_1_88_68	
uid_1_2_840_10008_5_1_4_1_1_88_69	
uid_1_2_840_10008_5_1_4_1_1_88_70	
uid_1_2_840_10008_5_1_4_1_1_88_71	
uid_1_2_840_10008_5_1_4_1_1_88_72	
uid_1_2_840_10008_5_1_4_1_1_88_73	
uid_1_2_840_10008_5_1_4_1_1_88_74	
uid_1_2_840_10008_5_1_4_1_1_88_75	
uid_1_2_840_10008_5_1_4_1_1_90_1	
uid_1_2_840_10008_5_1_4_1_1_104_3	
uid_1_2_840_10008_5_1_4_1_1_130	
uid_1_2_840_10008_5_1_4_1_1_131	
uid_1_2_840_10008_5_1_4_1_1_200_1	
uid_1_2_840_10008_5_1_4_1_1_200_2	
uid_1_2_840_10008_5_1_4_1_1_200_3	
uid_1_2_840_10008_5_1_4_1_1_200_4	
uid_1_2_840_10008_5_1_4_1_1_200_5	
uid_1_2_840_10008_5_1_4_1_1_200_6	
uid_1_2_840_10008_5_1_4_1_1_481_10	
uid_1_2_840_10008_5_1_4_1_1_481_11	
uid_1_2_840_10008_5_1_4_1_1_501_1	
uid_1_2_840_10008_5_1_4_1_1_501_2_1	
uid_1_2_840_10008_5_1_4_1_1_501_2_2	
uid_1_2_840_10008_5_1_4_1_1_501_3	

## Enumerator

uid_1_2_840_10008_5_1_4_1_1_501_4	
uid_1_2_840_10008_5_1_4_1_1_501_5	
uid_1_2_840_10008_5_1_4_1_1_501_6	
uid_1_2_840_10008_5_1_4_1_1_601_1	
uid_1_2_840_10008_5_1_4_1_1_601_2	
uid_1_2_840_10008_5_1_4_1_2_4_2	
uid_1_2_840_10008_5_1_4_1_2_4_3	
uid_1_2_840_10008_5_1_4_1_2_5_3	
uid_1_2_840_10008_5_1_4_20_1	
uid_1_2_840_10008_5_1_4_20_2	
uid_1_2_840_10008_5_1_4_20_3	
uid_1_2_840_10008_5_1_4_34_5_1	
uid_1_2_840_10008_5_1_4_34_6	
uid_1_2_840_10008_5_1_4_34_6_1	
uid_1_2_840_10008_5_1_4_34_6_2	
uid_1_2_840_10008_5_1_4_34_6_3	
uid_1_2_840_10008_5_1_4_34_6_4	
uid_1_2_840_10008_5_1_4_34_7	
uid_1_2_840_10008_5_1_4_34_8	
uid_1_2_840_10008_5_1_4_34_9	
uid_1_2_840_10008_5_1_4_34_10	
uid_1_2_840_10008_5_1_4_38_4	
uid_1_2_840_10008_5_1_4_39_1	
uid_1_2_840_10008_5_1_4_39_2	
uid_1_2_840_10008_5_1_4_39_3	
uid_1_2_840_10008_5_1_4_39_4	
uid_1_2_840_10008_5_1_4_43_1	
uid_1_2_840_10008_5_1_4_43_2	
uid_1_2_840_10008_5_1_4_43_3	
uid_1_2_840_10008_5_1_4_43_4	
uid_1_2_840_10008_5_1_4_44_1	
uid_1_2_840_10008_5_1_4_44_2	
uid_1_2_840_10008_5_1_4_44_3	
uid_1_2_840_10008_5_1_4_44_4	
uid_1_2_840_10008_5_1_4_45_1	
uid_1_2_840_10008_5_1_4_45_2	
uid_1_2_840_10008_5_1_4_45_3	
uid_1_2_840_10008_5_1_4_45_4	
uid_1_2_840_10008_7_1_1	
uid_1_2_840_10008_7_1_2	
uid_1_2_840_10008_8_1_1	
uid_1_2_840_10008_5_1_4_1_1_4_3	
uid_1_2_840_10008_15_1_1	

## 10.317.4 Member Function Documentation

### 10.317.4.1 GetName()

```
const char* gdcm::UIDs::GetName ( ) const
```

When object is Initialize function return the well known name associated with uid return NULL when not initialized

#### Examples

[GenerateStandardSOPClasses.cxx](#).

Referenced by `gdcm::operator<<()`.

### 10.317.4.2 GetNumberOfTransferSyntaxStrings()

```
static unsigned int gdcm::UIDs::GetNumberOfTransferSyntaxStrings ( ) [static]
```

### 10.317.4.3 GetString()

```
const char* gdcm::UIDs::GetString ( ) const
```

When object is Initialize function return the uid return NULL when not initialized

#### Examples

[GenerateStandardSOPClasses.cxx](#).

Referenced by `gdcm::operator<<()`.

### 10.317.4.4 GetTransferSyntaxString()

```
static const char* const* gdcm::UIDs::GetTransferSyntaxString (
    unsigned int ts ) [static]
```

#### 10.317.4.5 GetTransferSyntaxStrings()

```
static TransferSyntaxStringsType gdcM::UIDs::GetTransferSyntaxStrings ( ) [static]
```

#### 10.317.4.6 GetUIDName()

```
static const char* gdcM::UIDs::GetUIDName (
    unsigned int ts ) [static]
```

#### 10.317.4.7 GetUIDString()

```
static const char* gdcM::UIDs::GetUIDString (
    unsigned int ts ) [static]
```

#### 10.317.4.8 operator TSType()

```
gdcM::UIDs::operator TSType ( ) const [inline]
```

#### 10.317.4.9 SetFromUID()

```
bool gdcM::UIDs::SetFromUID (
    const char * str )
```

Initialize object from a string (a uid number) return false on error, and internal state is set to 0

#### Examples

[GenerateStandardSOPClasses.cxx](#).

The documentation for this class was generated from the following file:

- [gdcMUIDs.h](#)

## 10.318 gdcmm::network::ULAction Class Reference

[ULAction](#).

```
#include <gdcmmULAction.h>
```

Inheritance diagram for gdcmm::network::ULAction:

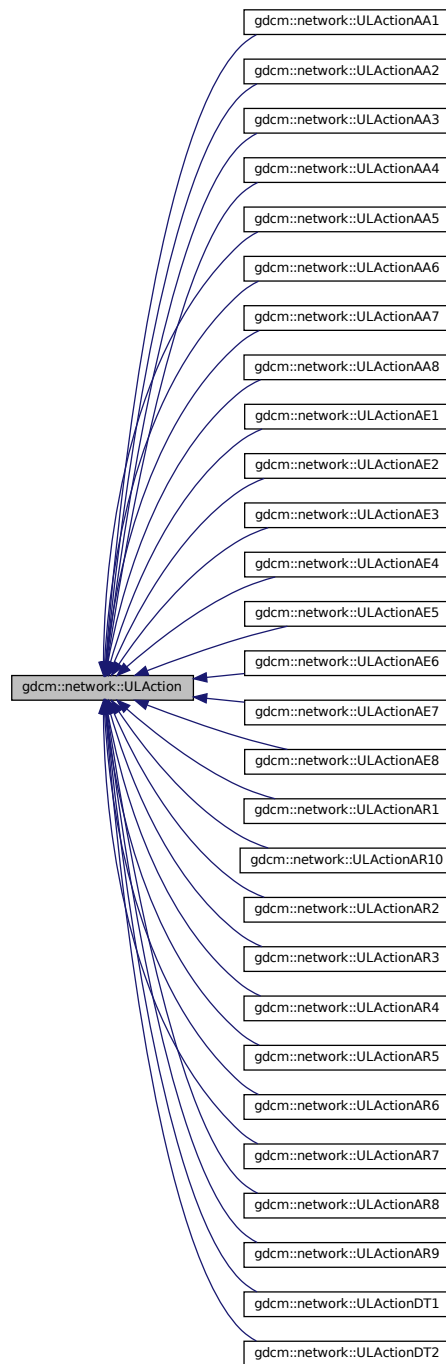

## Public Member Functions

- [ULAction](#) ()=default
- [ULAction](#) (const [ULAction](#) &inAction)=delete
- virtual [~ULAction](#) ()=default
- void [operator=](#) (const [ULAction](#) &)=delete
- virtual [EStateID PerformAction](#) ([Subject](#) \*s, [ULEvent](#) &inEvent, [ULConnection](#) &inConnection, bool &outWaiting, [ForEvent](#), [EEventID](#) &outRaisedEvent)=0

### 10.318.1 Detailed Description

#### [ULAction](#).

A [ULConnection](#) in a given ULState can perform certain ULActions. This base class provides the interface for running those ULActions on a given [ULConnection](#).

Essentially, the [ULConnectionManager](#) will take this object, determined from the current ULState of the [ULConnection](#), and pass the [ULConnection](#) object to the [ULAction](#). The [ULAction](#) will then invoke whatever necessary commands are required by a given action.

The result of a [ULAction](#) is a [ULEvent](#) (ie, what happened as a result of the action).

This [ULEvent](#) is passed to the ULState, so that the transition to the next state can occur.

Actions are associated with Payloads – be those filestreams, AETitles to establish connections, whatever. The actual parameters that the user will pass via an action will come through a Payload object, which should, in itself, be some gdcmm-based object (but not all objects can be payloads; sending a single dataelement as a payload isn't meaningful). As such, each action has its own particular payload.

For the sake of keeping files together, both the particular payload class and the action class will be defined in the same header file. Payloads should JUST be data (or streams), NO METHODS.

Some actions perform changes that should raise events on the local system, and some actions perform changes that will require waiting for events from the remote system.

Therefore, this base action has been modified so that those events are set by each action. When the event loop runs an action, it will then test to see if a local event was raised by the action, and if so, perform the appropriate subsequent action. If the action requires waiting for a response from the remote system, then the event loop will sit there (presumably with the ARTIM timer running) and wait for a response from the remote system. Once a response is obtained, then the the rest of the state transitions can happen.

### 10.318.2 Constructor & Destructor Documentation

#### 10.318.2.1 [ULAction](#)() [1/2]

```
gdcmm::network::ULAction::ULAction ( ) [default]
```



### 10.318.2.2 ~ULAction()

```
virtual gdcmm::network::ULAction::~~ULAction ( ) [virtual], [default]
```

### 10.318.2.3 ULAction() [2/2]

```
gdcmm::network::ULAction::ULAction (
    const ULAction & inAction ) [delete]
```

## 10.318.3 Member Function Documentation

### 10.318.3.1 operator=()

```
void gdcmm::network::ULAction::operator= (
    const ULAction & ) [delete]
```

### 10.318.3.2 PerformAction()

```
virtual EStateID gdcmm::network::ULAction::PerformAction (
    Subject * s,
    UEvent & inEvent,
    ULConnection & inConnection,
    bool & outWaitingForEvent,
    EEventID & outRaisedEvent ) [pure virtual]
```

Implemented in [gdcmm::network::ULActionDT2](#), [gdcmm::network::ULActionDT1](#), [gdcmm::network::ULActionAR10](#), [gdcmm::network::ULActionAR9](#), [gdcmm::network::ULActionAR8](#), [gdcmm::network::ULActionAR7](#), [gdcmm::network::ULActionAR6](#), [gdcmm::network::ULActionAR5](#), [gdcmm::network::ULActionAR4](#), [gdcmm::network::ULActionAR3](#), [gdcmm::network::ULActionAR2](#), [gdcmm::network::ULActionAR1](#), [gdcmm::network::ULActionAE8](#), [gdcmm::network::ULActionAE7](#), [gdcmm::network::ULActionAE6](#), [gdcmm::network::ULActionAE5](#), [gdcmm::network::ULActionAE4](#), [gdcmm::network::ULActionAE3](#), [gdcmm::network::ULActionAE2](#), [gdcmm::network::ULActionAE1](#), [gdcmm::network::ULActionAA8](#), [gdcmm::network::ULActionAA7](#), [gdcmm::network::ULActionAA6](#), [gdcmm::network::ULActionAA5](#), [gdcmm::network::ULActionAA4](#), [gdcmm::network::ULActionAA3](#), [gdcmm::network::ULActionAA2](#), and [gdcmm::network::ULActionAA1](#).

The documentation for this class was generated from the following file:

- [gdcmmULAction.h](#)

## 10.319 gdcmm::network::ULActionAA1 Class Reference

```
#include <gdcmmULActionAA.h>
```

Inheritance diagram for gdcmm::network::ULActionAA1:

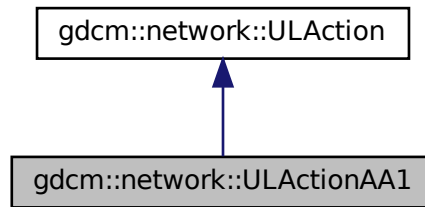

Collaboration diagram for gdcmm::network::ULActionAA1:

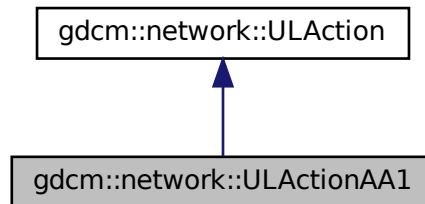

### Public Member Functions

- [EStateID PerformAction](#) ([Subject](#) \*s, [ULEvent](#) &inEvent, [ULConnection](#) &inConnection, bool &outWaitingForEvent, [EEventID](#) &outRaisedEvent) override

### 10.319.1 Member Function Documentation

### 10.319.1.1 PerformAction()

```
EStateID gdcm::network::ULActionAA1::PerformAction (  
    Subject * s,  
    ULEvent & inEvent,  
    ULConnection & inConnection,  
    bool & outWaitingForEvent,  
    EEventID & outRaisedEvent ) [override], [virtual]
```

Implements [gdcm::network::ULAction](#).

The documentation for this class was generated from the following file:

- [gdcmULActionAA.h](#)

## 10.320 gdcm::network::ULActionAA2 Class Reference

```
#include <gdcmULActionAA.h>
```

Inheritance diagram for `gdcm::network::ULActionAA2`:

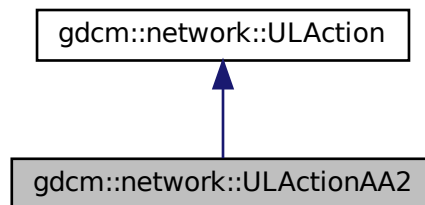

Collaboration diagram for `gdcm::network::ULActionAA2`:

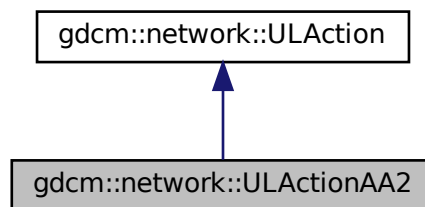

## Public Member Functions

- [EStateID PerformAction](#) ([Subject](#) \*s, [ULEvent](#) &inEvent, [ULConnection](#) &inConnection, bool &outWaitingForEvent, [EEventID](#) &outRaisedEvent) override

### 10.320.1 Member Function Documentation

#### 10.320.1.1 PerformAction()

```
EStateID gdcmm::network::ULActionAA2::PerformAction (  
    Subject * s,  
    ULEvent & inEvent,  
    ULConnection & inConnection,  
    bool & outWaitingForEvent,  
    EEventID & outRaisedEvent ) [override], [virtual]
```

Implements [gdcmm::network::ULAction](#).

The documentation for this class was generated from the following file:

- [gdcmmULActionAA.h](#)

## 10.321 gdcmm::network::ULActionAA3 Class Reference

```
#include <gdcmmULActionAA.h>
```

Inheritance diagram for [gdcmm::network::ULActionAA3](#):

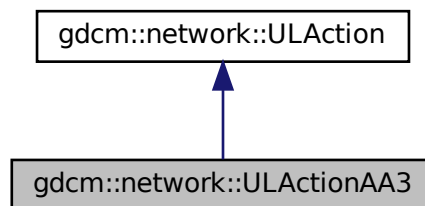

Collaboration diagram for gdcmm::network::ULActionAA3:

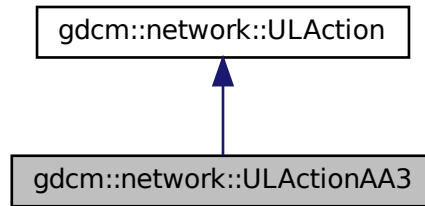

## Public Member Functions

- [EStateID PerformAction](#) ([Subject](#) \*s, [ULEvent](#) &inEvent, [ULConnection](#) &inConnection, bool &outWaitingForEvent, [EEventID](#) &outRaisedEvent) override

### 10.321.1 Member Function Documentation

#### 10.321.1.1 PerformAction()

```
EStateID gdcmm::network::ULActionAA3::PerformAction (  
    Subject * s,  
    ULEvent & inEvent,  
    ULConnection & inConnection,  
    bool & outWaitingForEvent,  
    EEventID & outRaisedEvent ) [override], [virtual]
```

Implements [gdcmm::network::ULAction](#).

The documentation for this class was generated from the following file:

- [gdcmmULActionAA.h](#)

## 10.322 gdcm::network::ULActionAA4 Class Reference

```
#include <gdcmULActionAA.h>
```

Inheritance diagram for gdcm::network::ULActionAA4:

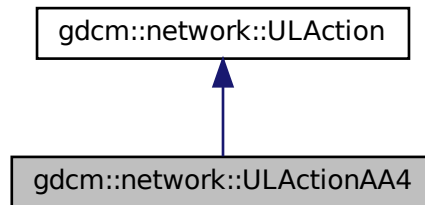

Collaboration diagram for gdcm::network::ULActionAA4:

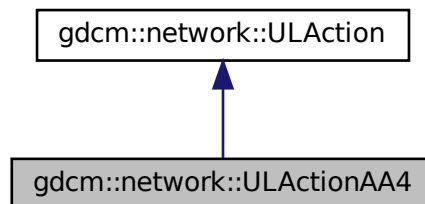

### Public Member Functions

- [EStateID PerformAction](#) ([Subject](#) \*s, [ULEvent](#) &inEvent, [ULConnection](#) &inConnection, bool &outWaitingFor↔  
Event, [EEventID](#) &outRaisedEvent) override

### 10.322.1 Member Function Documentation

### 10.322.1.1 PerformAction()

```
EStateID gdcmm::network::ULActionAA4::PerformAction (  
    Subject * s,  
    ULEvent & inEvent,  
    ULConnection & inConnection,  
    bool & outWaitingForEvent,  
    EEventID & outRaisedEvent ) [override], [virtual]
```

Implements [gdcmm::network::ULAction](#).

The documentation for this class was generated from the following file:

- [gdcmmULActionAA.h](#)

## 10.323 gdcmm::network::ULActionAA5 Class Reference

```
#include <gdcmmULActionAA.h>
```

Inheritance diagram for gdcmm::network::ULActionAA5:

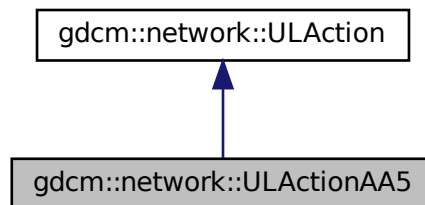

Collaboration diagram for gdcmm::network::ULActionAA5:

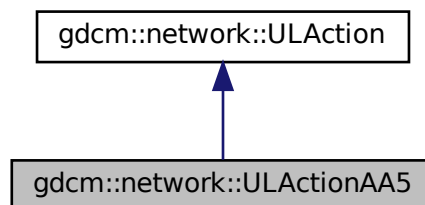

## Public Member Functions

- [EStateID PerformAction](#) ([Subject](#) \*s, [ULEvent](#) &inEvent, [ULConnection](#) &inConnection, bool &outWaitingForEvent, [EEventID](#) &outRaisedEvent) override

### 10.323.1 Member Function Documentation

#### 10.323.1.1 PerformAction()

```
EStateID gdcmm::network::ULActionAA5::PerformAction (  
    Subject * s,  
    ULEvent & inEvent,  
    ULConnection & inConnection,  
    bool & outWaitingForEvent,  
    EEventID & outRaisedEvent ) [override], [virtual]
```

Implements [gdcmm::network::ULAction](#).

The documentation for this class was generated from the following file:

- [gdcmmULActionAA.h](#)

### 10.324 gdcmm::network::ULActionAA6 Class Reference

```
#include <gdcmmULActionAA.h>
```

Inheritance diagram for [gdcmm::network::ULActionAA6](#):

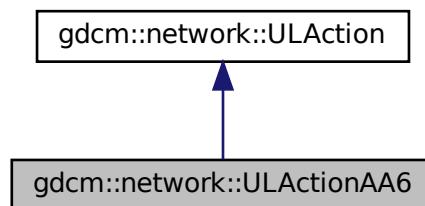



Collaboration diagram for gdcm::network::ULActionAA6:

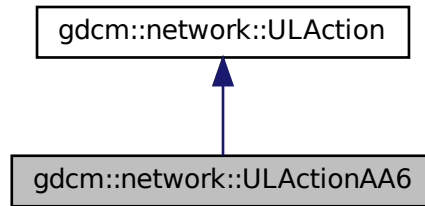

## Public Member Functions

- [EStateID PerformAction](#) ([Subject](#) \*s, [ULEvent](#) &inEvent, [ULConnection](#) &inConnection, bool &outWaitingForEvent, [EEventID](#) &outRaisedEvent) override

### 10.324.1 Member Function Documentation

#### 10.324.1.1 PerformAction()

```
EStateID gdcm::network::ULActionAA6::PerformAction (  
    Subject * s,  
    ULEvent & inEvent,  
    ULConnection & inConnection,  
    bool & outWaitingForEvent,  
    EEventID & outRaisedEvent ) [override], [virtual]
```

Implements [gdcm::network::ULAction](#).

The documentation for this class was generated from the following file:

- [gdcmULActionAA.h](#)

## 10.325 gdcm::network::ULActionAA7 Class Reference

```
#include <gdcmULActionAA.h>
```

Inheritance diagram for gdcm::network::ULActionAA7:

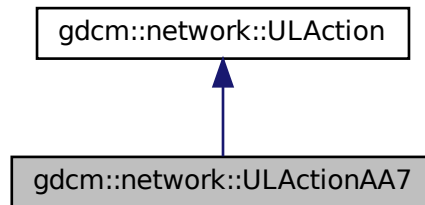

Collaboration diagram for gdcm::network::ULActionAA7:

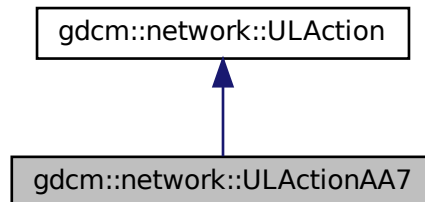

### Public Member Functions

- `EStateID PerformAction (Subject *s, ULEvent &inEvent, ULConnection &inConnection, bool &outWaitingForEvent, EEventID &outRaisedEvent) override`

### 10.325.1 Member Function Documentation

### 10.325.1.1 PerformAction()

```
EStateID gdcmm::network::ULActionAA7::PerformAction (  
    Subject * s,  
    ULEvent & inEvent,  
    ULConnection & inConnection,  
    bool & outWaitingForEvent,  
    EEventID & outRaisedEvent ) [override], [virtual]
```

Implements [gdcmm::network::ULAction](#).

The documentation for this class was generated from the following file:

- [gdcmmULActionAA.h](#)

## 10.326 gdcmm::network::ULActionAA8 Class Reference

```
#include <gdcmmULActionAA.h>
```

Inheritance diagram for gdcmm::network::ULActionAA8:

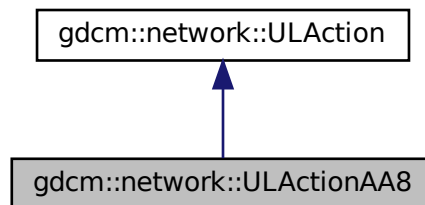

Collaboration diagram for gdcmm::network::ULActionAA8:

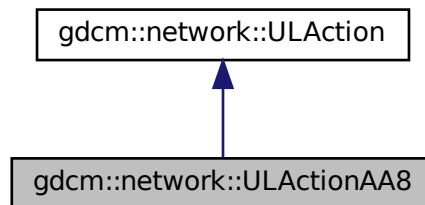

## Public Member Functions

- [EStateID PerformAction](#) ([Subject](#) \*s, [ULEvent](#) &inEvent, [ULConnection](#) &inConnection, bool &outWaitingForEvent, [EEventID](#) &outRaisedEvent) override

### 10.326.1 Member Function Documentation

#### 10.326.1.1 PerformAction()

```
EStateID gdcmm::network::ULActionAA8::PerformAction (  
    Subject * s,  
    ULEvent & inEvent,  
    ULConnection & inConnection,  
    bool & outWaitingForEvent,  
    EEventID & outRaisedEvent ) [override], [virtual]
```

Implements [gdcmm::network::ULAction](#).

The documentation for this class was generated from the following file:

- [gdcmmULActionAA.h](#)

### 10.327 gdcmm::network::ULActionAE1 Class Reference

```
#include <gdcmmULActionAE.h>
```

Inheritance diagram for [gdcmm::network::ULActionAE1](#):

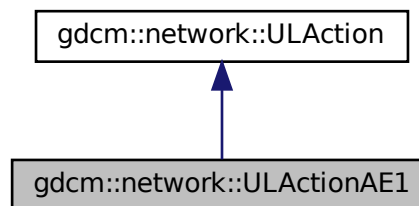

Collaboration diagram for gdcm::network::ULActionAE1:

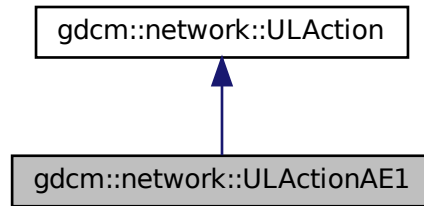

## Public Member Functions

- [EStateID PerformAction](#) ([Subject](#) \*s, [ULEvent](#) &inEvent, [ULConnection](#) &inConnection, bool &outWaitingForEvent, [EEventID](#) &outRaisedEvent) override

### 10.327.1 Member Function Documentation

#### 10.327.1.1 PerformAction()

```
EStateID gdcm::network::ULActionAE1::PerformAction (  
    Subject * s,  
    ULEvent & inEvent,  
    ULConnection & inConnection,  
    bool & outWaitingForEvent,  
    EEventID & outRaisedEvent ) [override], [virtual]
```

Implements [gdcm::network::ULAction](#).

The documentation for this class was generated from the following file:

- [gdcmULActionAE.h](#)

## 10.328 gdcm::network::ULActionAE2 Class Reference

```
#include <gdcmULActionAE.h>
```

Inheritance diagram for gdcm::network::ULActionAE2:

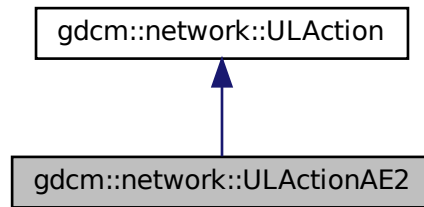

Collaboration diagram for gdcm::network::ULActionAE2:

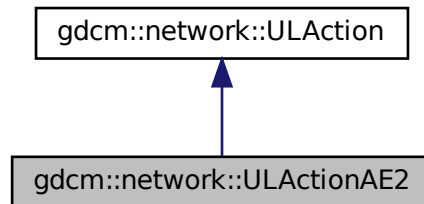

### Public Member Functions

- [EStateID PerformAction](#) ([Subject](#) \*s, [ULEvent](#) &inEvent, [ULConnection](#) &inConnection, bool &outWaitingFor←  
Event, [EEventID](#) &outRaisedEvent) override

### 10.328.1 Member Function Documentation

### 10.328.1.1 PerformAction()

```
EStateID gdcmm::network::ULActionAE2::PerformAction (  
    Subject * s,  
    ULEvent & inEvent,  
    ULConnection & inConnection,  
    bool & outWaitingForEvent,  
    EEventID & outRaisedEvent ) [override], [virtual]
```

Implements [gdcmm::network::ULAction](#).

The documentation for this class was generated from the following file:

- [gdcmmULActionAE.h](#)

## 10.329 gdcmm::network::ULActionAE3 Class Reference

```
#include <gdcmmULActionAE.h>
```

Inheritance diagram for gdcmm::network::ULActionAE3:

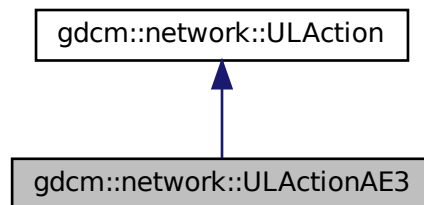

Collaboration diagram for gdcmm::network::ULActionAE3:

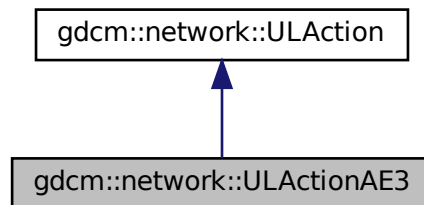

## Public Member Functions

- [EStateID PerformAction](#) ([Subject](#) \*s, [ULEvent](#) &inEvent, [ULConnection](#) &inConnection, bool &outWaitingForEvent, [EEventID](#) &outRaisedEvent) override

### 10.329.1 Member Function Documentation

#### 10.329.1.1 PerformAction()

```
EStateID gdcmm::network::ULActionAE3::PerformAction (  
    Subject * s,  
    ULEvent & inEvent,  
    ULConnection & inConnection,  
    bool & outWaitingForEvent,  
    EEventID & outRaisedEvent ) [override], [virtual]
```

Implements [gdcmm::network::ULAction](#).

The documentation for this class was generated from the following file:

- [gdcmmULActionAE.h](#)

## 10.330 gdcmm::network::ULActionAE4 Class Reference

```
#include <gdcmmULActionAE.h>
```

Inheritance diagram for [gdcmm::network::ULActionAE4](#):

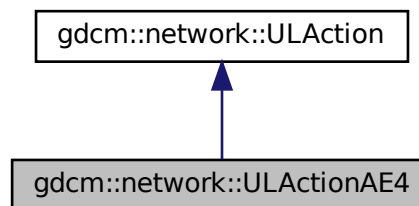



Collaboration diagram for gdcn::network::ULActionAE4:

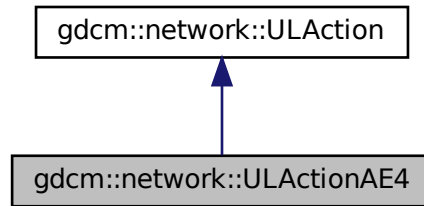

## Public Member Functions

- [EStateID PerformAction](#) ([Subject](#) \*s, [ULEvent](#) &inEvent, [ULConnection](#) &inConnection, bool &outWaitingForEvent, [EEventID](#) &outRaisedEvent) override

### 10.330.1 Member Function Documentation

#### 10.330.1.1 PerformAction()

```
EStateID gdcn::network::ULActionAE4::PerformAction (
    Subject * s,
    ULEvent & inEvent,
    ULConnection & inConnection,
    bool & outWaitingForEvent,
    EEventID & outRaisedEvent ) [override], [virtual]
```

Implements [gdcn::network::ULAction](#).

The documentation for this class was generated from the following file:

- [gdcnULActionAE.h](#)

## 10.331 gdcmm::network::ULActionAE5 Class Reference

```
#include <gdcmmULActionAE.h>
```

Inheritance diagram for gdcmm::network::ULActionAE5:

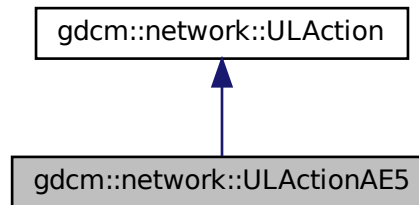

Collaboration diagram for gdcmm::network::ULActionAE5:

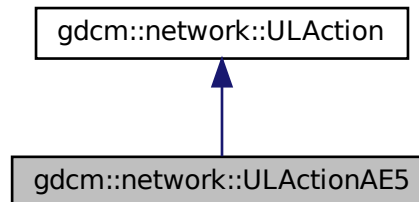

### Public Member Functions

- `EStateID PerformAction (Subject *s, ULEvent &inEvent, ULConnection &inConnection, bool &outWaitingForEvent, EEventID &outRaisedEvent) override`

#### 10.331.1 Member Function Documentation

### 10.331.1.1 PerformAction()

```
EStateID gdcm::network::ULActionAE5::PerformAction (  
    Subject * s,  
    ULEvent & inEvent,  
    ULConnection & inConnection,  
    bool & outWaitingForEvent,  
    EEventID & outRaisedEvent ) [override], [virtual]
```

Implements [gdcm::network::ULAction](#).

The documentation for this class was generated from the following file:

- [gdcmULActionAE.h](#)

## 10.332 gdcm::network::ULActionAE6 Class Reference

```
#include <gdcmULActionAE.h>
```

Inheritance diagram for gdcm::network::ULActionAE6:

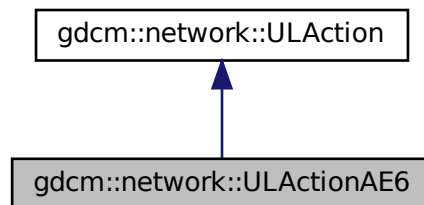

Collaboration diagram for gdcm::network::ULActionAE6:

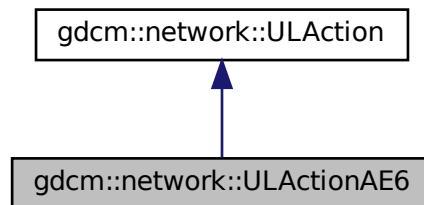

## Public Member Functions

- [EStateID PerformAction](#) ([Subject](#) \*s, [ULEvent](#) &inEvent, [ULConnection](#) &inConnection, bool &outWaitingForEvent, [EEventID](#) &outRaisedEvent) override

### 10.332.1 Member Function Documentation

#### 10.332.1.1 PerformAction()

```
EStateID gdcmm::network::ULActionAE6::PerformAction (  
    Subject * s,  
    ULEvent & inEvent,  
    ULConnection & inConnection,  
    bool & outWaitingForEvent,  
    EEventID & outRaisedEvent ) [override], [virtual]
```

Implements [gdcmm::network::ULAction](#).

The documentation for this class was generated from the following file:

- [gdcmmULActionAE.h](#)

### 10.333 gdcmm::network::ULActionAE7 Class Reference

```
#include <gdcmmULActionAE.h>
```

Inheritance diagram for [gdcmm::network::ULActionAE7](#):

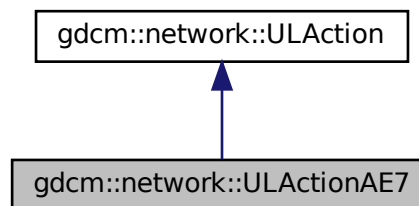

Collaboration diagram for gdcmm::network::ULActionAE7:

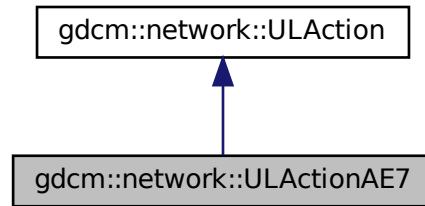

## Public Member Functions

- [EStateID PerformAction](#) ([Subject](#) \*s, [ULEvent](#) &inEvent, [ULConnection](#) &inConnection, bool &outWaitingForEvent, [EEventID](#) &outRaisedEvent) override

### 10.333.1 Member Function Documentation

#### 10.333.1.1 PerformAction()

```
EStateID gdcmm::network::ULActionAE7::PerformAction (  
    Subject * s,  
    ULEvent & inEvent,  
    ULConnection & inConnection,  
    bool & outWaitingForEvent,  
    EEventID & outRaisedEvent ) [override], [virtual]
```

Implements [gdcmm::network::ULAction](#).

The documentation for this class was generated from the following file:

- [gdcmmULActionAE.h](#)

## 10.334 gdcm::network::ULActionAE8 Class Reference

```
#include <gdcmULActionAE.h>
```

Inheritance diagram for gdcm::network::ULActionAE8:

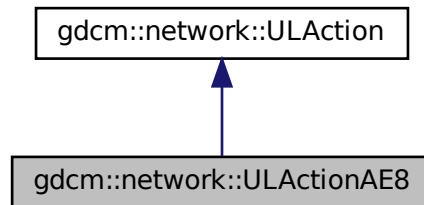

Collaboration diagram for gdcm::network::ULActionAE8:

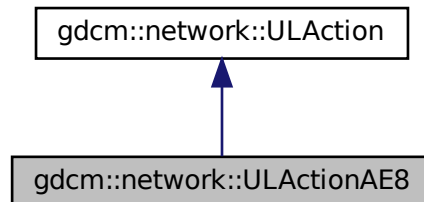

### Public Member Functions

- `EStateID PerformAction (Subject *s, ULEvent &inEvent, ULConnection &inConnection, bool &outWaitingForEvent, EEventID &outRaisedEvent) override`

#### 10.334.1 Member Function Documentation

### 10.334.1.1 PerformAction()

```
EStateID gdcmm::network::ULActionAE8::PerformAction (  
    Subject * s,  
    ULEvent & inEvent,  
    ULConnection & inConnection,  
    bool & outWaitingForEvent,  
    EEventID & outRaisedEvent ) [override], [virtual]
```

Implements [gdcmm::network::ULAction](#).

The documentation for this class was generated from the following file:

- [gdcmmULActionAE.h](#)

## 10.335 gdcmm::network::ULActionAR1 Class Reference

```
#include <gdcmmULActionAR.h>
```

Inheritance diagram for gdcmm::network::ULActionAR1:

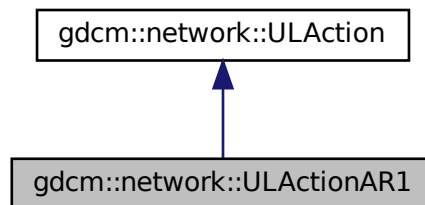

Collaboration diagram for gdcmm::network::ULActionAR1:

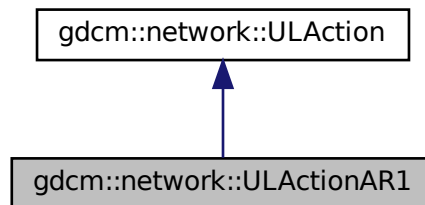

## Public Member Functions

- [EStateID PerformAction](#) ([Subject](#) \*s, [ULEvent](#) &inEvent, [ULConnection](#) &inConnection, bool &outWaitingForEvent, [EEventID](#) &outRaisedEvent) override

### 10.335.1 Member Function Documentation

#### 10.335.1.1 PerformAction()

```
EStateID gdcM::network::ULActionAR1::PerformAction (
    Subject * s,
    ULEvent & inEvent,
    ULConnection & inConnection,
    bool & outWaitingForEvent,
    EEventID & outRaisedEvent ) [override], [virtual]
```

Implements [gdcM::network::ULAction](#).

The documentation for this class was generated from the following file:

- [gdcMULActionAR.h](#)

## 10.336 gdcM::network::ULActionAR10 Class Reference

```
#include <gdcMULActionAR.h>
```

Inheritance diagram for [gdcM::network::ULActionAR10](#):

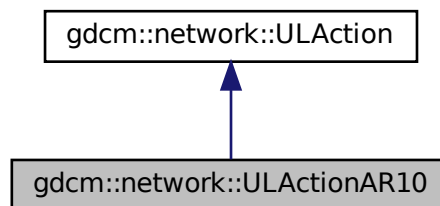



Collaboration diagram for gdcm::network::ULActionAR10:

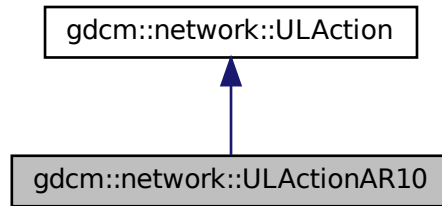

## Public Member Functions

- [EStateID PerformAction](#) ([Subject](#) \*s, [ULEvent](#) &inEvent, [ULConnection](#) &inConnection, bool &outWaitingForEvent, [EEventID](#) &outRaisedEvent) override

### 10.336.1 Member Function Documentation

#### 10.336.1.1 PerformAction()

```
EStateID gdcm::network::ULActionAR10::PerformAction (
    Subject * s,
    ULEvent & inEvent,
    ULConnection & inConnection,
    bool & outWaitingForEvent,
    EEventID & outRaisedEvent ) [override], [virtual]
```

Implements [gdcm::network::ULAction](#).

The documentation for this class was generated from the following file:

- [gdcmULActionAR.h](#)

## 10.337 gdcm::network::ULActionAR2 Class Reference

```
#include <gdcmULActionAR.h>
```

Inheritance diagram for gdcm::network::ULActionAR2:

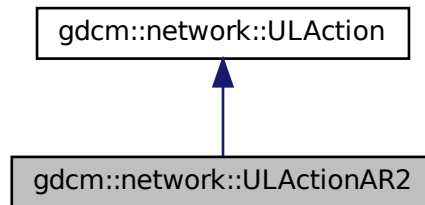

Collaboration diagram for gdcm::network::ULActionAR2:

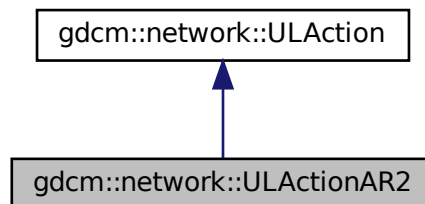

### Public Member Functions

- `EStateID PerformAction (Subject *s, ULEvent &inEvent, ULConnection &inConnection, bool &outWaitingForEvent, EEventID &outRaisedEvent) override`

### 10.337.1 Member Function Documentation

### 10.337.1.1 PerformAction()

```
EStateID gdcmm::network::ULActionAR2::PerformAction (  
    Subject * s,  
    ULEvent & inEvent,  
    ULConnection & inConnection,  
    bool & outWaitingForEvent,  
    EEventID & outRaisedEvent ) [override], [virtual]
```

Implements [gdcmm::network::ULAction](#).

The documentation for this class was generated from the following file:

- [gdcmmULActionAR.h](#)

## 10.338 gdcmm::network::ULActionAR3 Class Reference

```
#include <gdcmmULActionAR.h>
```

Inheritance diagram for gdcmm::network::ULActionAR3:

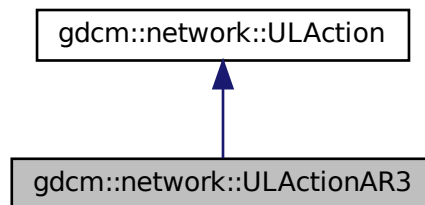

Collaboration diagram for gdcmm::network::ULActionAR3:

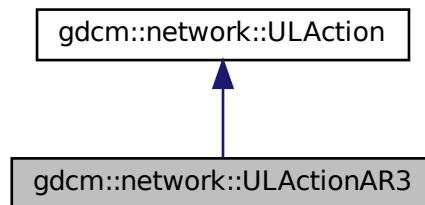

## Public Member Functions

- [EStateID PerformAction](#) ([Subject](#) \*s, [ULEvent](#) &inEvent, [ULConnection](#) &inConnection, bool &outWaitingForEvent, [EEventID](#) &outRaisedEvent) override

### 10.338.1 Member Function Documentation

#### 10.338.1.1 PerformAction()

```
EStateID gdcmm::network::ULActionAR3::PerformAction (  
    Subject * s,  
    ULEvent & inEvent,  
    ULConnection & inConnection,  
    bool & outWaitingForEvent,  
    EEventID & outRaisedEvent ) [override], [virtual]
```

Implements [gdcmm::network::ULAction](#).

The documentation for this class was generated from the following file:

- [gdcmmULActionAR.h](#)

### 10.339 gdcmm::network::ULActionAR4 Class Reference

```
#include <gdcmmULActionAR.h>
```

Inheritance diagram for [gdcmm::network::ULActionAR4](#):

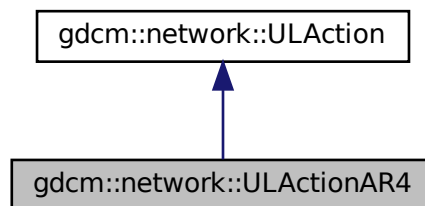

Collaboration diagram for gdcm::network::ULActionAR4:

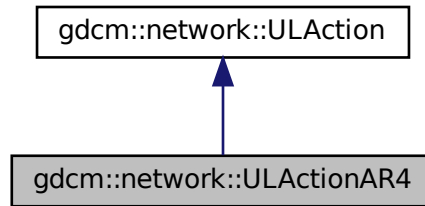

## Public Member Functions

- [EStateID PerformAction](#) ([Subject](#) \*s, [ULEvent](#) &inEvent, [ULConnection](#) &inConnection, bool &outWaitingForEvent, [EEventID](#) &outRaisedEvent) override

### 10.339.1 Member Function Documentation

#### 10.339.1.1 PerformAction()

```
EStateID gdcm::network::ULActionAR4::PerformAction (
    Subject * s,
    ULEvent & inEvent,
    ULConnection & inConnection,
    bool & outWaitingForEvent,
    EEventID & outRaisedEvent ) [override], [virtual]
```

Implements [gdcm::network::ULAction](#).

The documentation for this class was generated from the following file:

- [gdcmULActionAR.h](#)

## 10.340 gdcm::network::ULActionAR5 Class Reference

```
#include <gdcmULActionAR.h>
```

Inheritance diagram for gdcm::network::ULActionAR5:

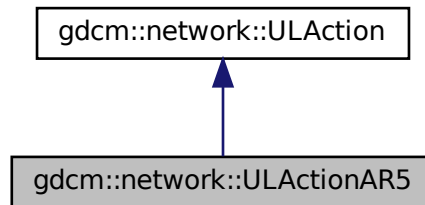

Collaboration diagram for gdcm::network::ULActionAR5:

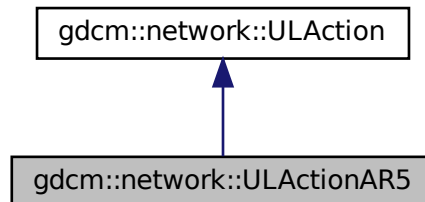

### Public Member Functions

- [EStateID PerformAction](#) ([Subject](#) \*s, [ULEvent](#) &inEvent, [ULConnection](#) &inConnection, bool &outWaitingFor←  
Event, [EEventID](#) &outRaisedEvent) override

### 10.340.1 Member Function Documentation

### 10.340.1.1 PerformAction()

```
EStateID gdcm::network::ULActionAR5::PerformAction (  
    Subject * s,  
    ULEvent & inEvent,  
    ULConnection & inConnection,  
    bool & outWaitingForEvent,  
    EEventID & outRaisedEvent ) [override], [virtual]
```

Implements [gdcm::network::ULAction](#).

The documentation for this class was generated from the following file:

- [gdcmULActionAR.h](#)

## 10.341 gdcm::network::ULActionAR6 Class Reference

```
#include <gdcmULActionAR.h>
```

Inheritance diagram for gdcm::network::ULActionAR6:

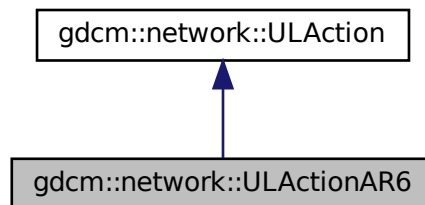

Collaboration diagram for gdcm::network::ULActionAR6:

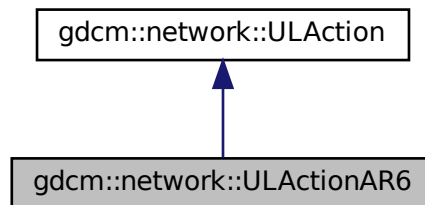

## Public Member Functions

- [EStateID PerformAction](#) ([Subject](#) \*s, [ULEvent](#) &inEvent, [ULConnection](#) &inConnection, bool &outWaitingForEvent, [EEventID](#) &outRaisedEvent) override

### 10.341.1 Member Function Documentation

#### 10.341.1.1 PerformAction()

```
EStateID gdcmm::network::ULActionAR6::PerformAction (  
    Subject * s,  
    ULEvent & inEvent,  
    ULConnection & inConnection,  
    bool & outWaitingForEvent,  
    EEventID & outRaisedEvent ) [override], [virtual]
```

Implements [gdcmm::network::ULAction](#).

The documentation for this class was generated from the following file:

- [gdcmmULActionAR.h](#)

## 10.342 gdcmm::network::ULActionAR7 Class Reference

```
#include <gdcmmULActionAR.h>
```

Inheritance diagram for [gdcmm::network::ULActionAR7](#):

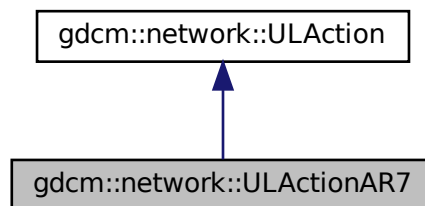



Collaboration diagram for gdcm::network::ULActionAR7:

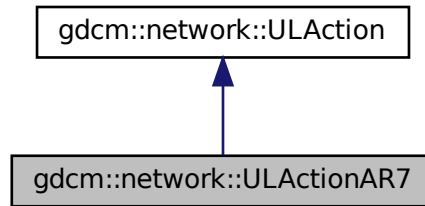

## Public Member Functions

- [EStateID PerformAction](#) ([Subject](#) \*s, [ULEvent](#) &inEvent, [ULConnection](#) &inConnection, bool &outWaitingForEvent, [EEventID](#) &outRaisedEvent) override

### 10.342.1 Member Function Documentation

#### 10.342.1.1 PerformAction()

```
EStateID gdcm::network::ULActionAR7::PerformAction (
    Subject * s,
    ULEvent & inEvent,
    ULConnection & inConnection,
    bool & outWaitingForEvent,
    EEventID & outRaisedEvent ) [override], [virtual]
```

Implements [gdcm::network::ULAction](#).

The documentation for this class was generated from the following file:

- [gdcmULActionAR.h](#)

## 10.343 gdcm::network::ULActionAR8 Class Reference

```
#include <gdcmULActionAR.h>
```

Inheritance diagram for gdcm::network::ULActionAR8:

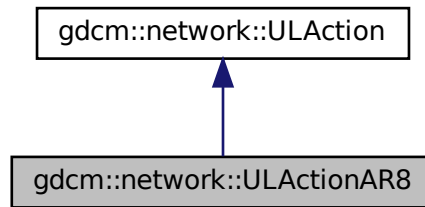

Collaboration diagram for gdcm::network::ULActionAR8:

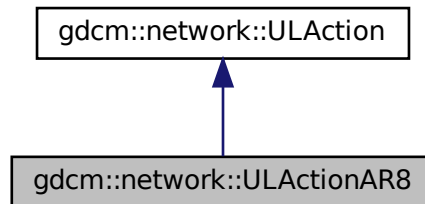

### Public Member Functions

- `EStateID PerformAction (Subject *s, ULEvent &inEvent, ULConnection &inConnection, bool &outWaitingForEvent, EEventID &outRaisedEvent) override`

### 10.343.1 Member Function Documentation

### 10.343.1.1 PerformAction()

```
EStateID gdcm::network::ULActionAR8::PerformAction (  
    Subject * s,  
    ULEvent & inEvent,  
    ULConnection & inConnection,  
    bool & outWaitingForEvent,  
    EEventID & outRaisedEvent ) [override], [virtual]
```

Implements [gdcm::network::ULAction](#).

The documentation for this class was generated from the following file:

- [gdcmULActionAR.h](#)

## 10.344 gdcm::network::ULActionAR9 Class Reference

```
#include <gdcmULActionAR.h>
```

Inheritance diagram for gdcm::network::ULActionAR9:

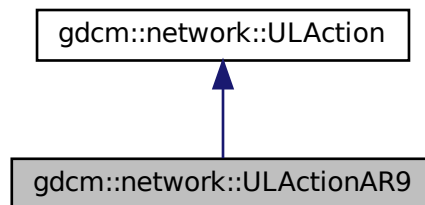

Collaboration diagram for gdcm::network::ULActionAR9:

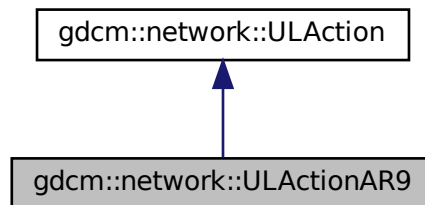

## Public Member Functions

- [EStateID PerformAction](#) ([Subject](#) \*s, [ULEvent](#) &inEvent, [ULConnection](#) &inConnection, bool &outWaitingForEvent, [EEventID](#) &outRaisedEvent) override

### 10.344.1 Member Function Documentation

#### 10.344.1.1 PerformAction()

```
EStateID gdcmm::network::ULActionAR9::PerformAction (  
    Subject * s,  
    ULEvent & inEvent,  
    ULConnection & inConnection,  
    bool & outWaitingForEvent,  
    EEventID & outRaisedEvent ) [override], [virtual]
```

Implements [gdcmm::network::ULAction](#).

The documentation for this class was generated from the following file:

- [gdcmmULActionAR.h](#)

## 10.345 gdcmm::network::ULActionDT1 Class Reference

```
#include <gdcmmULActionDT.h>
```

Inheritance diagram for [gdcmm::network::ULActionDT1](#):

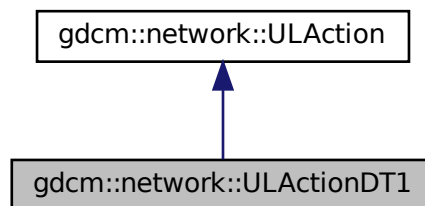

Collaboration diagram for gdcm::network::ULActionDT1:

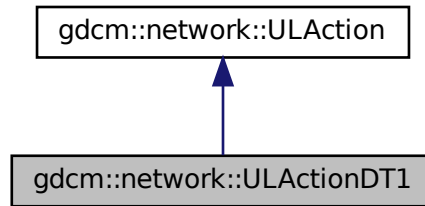

## Public Member Functions

- [EStateID PerformAction](#) ([Subject](#) \*s, [ULEvent](#) &inEvent, [ULConnection](#) &inConnection, bool &outWaitingForEvent, [EEventID](#) &outRaisedEvent) override

### 10.345.1 Member Function Documentation

#### 10.345.1.1 PerformAction()

```
EStateID gdcm::network::ULActionDT1::PerformAction (  
    Subject * s,  
    ULEvent & inEvent,  
    ULConnection & inConnection,  
    bool & outWaitingForEvent,  
    EEventID & outRaisedEvent ) [override], [virtual]
```

Implements [gdcm::network::ULAction](#).

The documentation for this class was generated from the following file:

- [gdcmULActionDT.h](#)

## 10.346 gdcm::network::ULActionDT2 Class Reference

```
#include <gdcmULActionDT.h>
```

Inheritance diagram for gdcm::network::ULActionDT2:

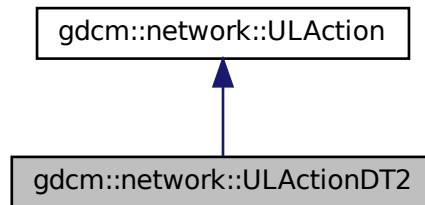

Collaboration diagram for gdcm::network::ULActionDT2:

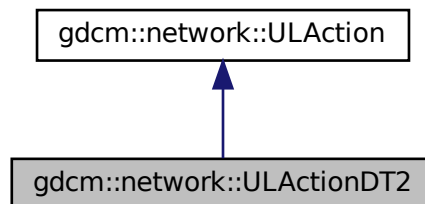

### Public Member Functions

- [EStateID PerformAction](#) ([Subject](#) \*s, [ULEvent](#) &inEvent, [ULConnection](#) &inConnection, bool &outWaitingFor←  
Event, [EEventID](#) &outRaisedEvent) override

### 10.346.1 Member Function Documentation

### 10.346.1.1 PerformAction()

```
EStateID gdcm::network::ULActionDT2::PerformAction (  
    Subject * s,  
    ULEvent & inEvent,  
    ULConnection & inConnection,  
    bool & outWaitingForEvent,  
    EEventID & outRaisedEvent ) [override], [virtual]
```

Implements [gdcm::network::ULAction](#).

The documentation for this class was generated from the following file:

- [gdcmULActionDT.h](#)

## 10.347 gdcm::network::ULBasicCallback Class Reference

[ULBasicCallback](#).

```
#include <gdcmULBasicCallback.h>
```

Inheritance diagram for `gdcm::network::ULBasicCallback`:

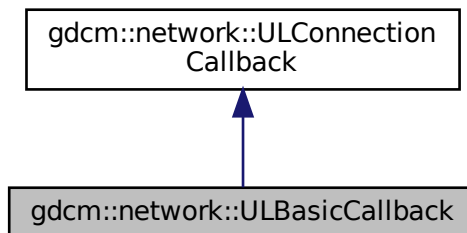

Collaboration diagram for `gdcm::network::ULBasicCallback`:

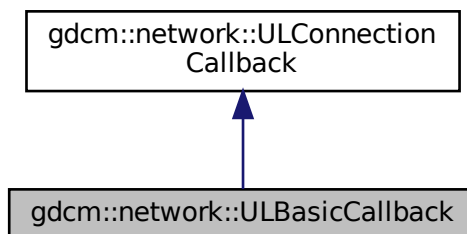

## Public Member Functions

- [ULBasicCallback](#) ()=default
- [~ULBasicCallback](#) () override=default
- `std::vector< DataSet > const & GetDataSets () const`
- `std::vector< DataSet > const & GetResponses () const`
- `void HandleDataSet (const DataSet &inDataSet) override`
- `void HandleResponse (const DataSet &inDataSet) override`

## Additional Inherited Members

### 10.347.1 Detailed Description

[ULBasicCallback](#).

This is the most basic of callbacks for how the [ULConnectionManager](#) handles incoming datasets. DataSets are just concatenated to the mDataSets vector, and the result can be pulled out of the vector by later code. Alternatives to this method include progress updates, saving to disk, etc. This class is NOT THREAD SAFE. Access the dataset vector after the entire set of datasets has been returned by the [ULConnectionManager](#).

### 10.347.2 Constructor & Destructor Documentation

#### 10.347.2.1 [ULBasicCallback](#)()

```
gdcmm::network::ULBasicCallback::ULBasicCallback ( ) [default]
```

#### 10.347.2.2 [~ULBasicCallback](#)()

```
gdcmm::network::ULBasicCallback::~~ULBasicCallback ( ) [override], [default]
```

### 10.347.3 Member Function Documentation

#### 10.347.3.1 [GetDataSets](#)()

```
std::vector<DataSet> const& gdcmm::network::ULBasicCallback::GetDataSets ( ) const
```



### 10.347.3.2 GetResponses()

```
std::vector<DataSet> const& gdcm::network::ULBasicCallback::GetResponses ( ) const
```

### 10.347.3.3 HandleDataSet()

```
void gdcm::network::ULBasicCallback::HandleDataSet (
    const DataSet & inDataSet ) [override], [virtual]
```

Implements [gdcm::network::ULConnectionCallback](#).

### 10.347.3.4 HandleResponse()

```
void gdcm::network::ULBasicCallback::HandleResponse (
    const DataSet & inDataSet ) [override], [virtual]
```

Implements [gdcm::network::ULConnectionCallback](#).

The documentation for this class was generated from the following file:

- [gdcmULBasicCallback.h](#)

## 10.348 gdcm::network::ULConnection Class Reference

[ULConnection](#).

```
#include <gdcmULConnection.h>
```

## Public Member Functions

- [ULConnection](#) (const [ULConnection](#) &)=delete
- [ULConnection](#) (const [ULConnectionInfo](#) &inUserInformation)
- virtual [~ULConnection](#) ()
- void [AddAcceptedPresentationContext](#) (const [PresentationContextAC](#) &inPC)
- [PresentationContextRQ](#) [FindContext](#) (const [DataElement](#) &de) const
- std::vector< [PresentationContextAC](#) > & [GetAcceptedPresentationContexts](#) ()
- std::vector< [PresentationContextAC](#) > const & [GetAcceptedPresentationContexts](#) () const
- const [ULConnectionInfo](#) & [GetConnectionInfo](#) () const
- uint32\_t [GetMaxPDUSize](#) () const
- const [PresentationContextAC](#) \* [GetPresentationContextACByID](#) (uint8\_t id) const
- uint8\_t [GetPresentationContextIDFromPresentationContext](#) ([PresentationContextRQ](#) const &pc) const  
*return 0 upon error*
- const [PresentationContextRQ](#) \* [GetPresentationContextRQByID](#) (uint8\_t id) const
- std::vector< [PresentationContextRQ](#) > const & [GetPresentationContexts](#) () const
- std::iostream \* [GetProtocol](#) ()
- [EStateID](#) [GetState](#) () const
- [ARTIMTimer](#) & [GetTimer](#) ()
- bool [InitializeConnection](#) ()  
*used to establish scu connections*
- bool [InitializeIncomingConnection](#) ()  
*used to establish scp connections*
- void [operator=](#) (const [ULConnection](#) &)=delete
- void [SetMaxPDUSize](#) (uint32\_t inSize)
- void [SetPresentationContexts](#) (const std::vector< [PresentationContext](#) > &inContexts)
- void [SetPresentationContexts](#) (const std::vector< [PresentationContextRQ](#) > &inContexts)
- void [SetState](#) (const [EStateID](#) &inState)
- void [StopProtocol](#) ()

## Friends

- class [ULActionAE6](#)
- class [ULConnectionManager](#)

### 10.348.1 Detailed Description

#### [ULConnection](#).

This is the class that contains the socket to another machine, and passes data through itself, as well as maintaining a sense of state.

The [ULConnectionManager](#) tells the [ULConnection](#) what data can actually be sent.

This class is done this way so that it can be eventually be replaced with a [ULSecureConnection](#), if such a protocol is warranted, so that all data that passes through can be managed through a secure connection. For now, this class provides a simple pass-through mechanism to the socket itself.

So, for instance, a [gdcM](#) object will be passes to this object, and it will then get passed along the connection, if that connection is in the proper state to do so.

For right now, this class is not directly intended to be inherited from, but the potential for future [ULSecureConnection](#) warrants the addition, rather than having everything be managed from within the [ULConnectionManager](#) (or this class) without a wrapper.

## 10.348.2 Constructor & Destructor Documentation

### 10.348.2.1 ULConnection() [1/2]

```
gdcm::network::ULConnection::ULConnection (
    const ULConnectionInfo & inUserInformation )
```

### 10.348.2.2 ~ULConnection()

```
virtual gdcm::network::ULConnection::~~ULConnection ( ) [virtual]
```

### 10.348.2.3 ULConnection() [2/2]

```
gdcm::network::ULConnection::ULConnection (
    const ULConnection & ) [delete]
```

## 10.348.3 Member Function Documentation

### 10.348.3.1 AddAcceptedPresentationContext()

```
void gdcm::network::ULConnection::AddAcceptedPresentationContext (
    const PresentationContextAC & inPC )
```

### 10.348.3.2 FindContext()

```
PresentationContextRQ gdcm::network::ULConnection::FindContext (
    const DataElement & de ) const
```

### 10.348.3.3 GetAcceptedPresentationContexts() [1/2]

```
std::vector<PresentationContextAC>& gdc::network::ULConnection::GetAcceptedPresentationContexts  
( )
```

### 10.348.3.4 GetAcceptedPresentationContexts() [2/2]

```
std::vector<PresentationContextAC> const& gdc::network::ULConnection::GetAcceptedPresentation↵  
Contexts ( ) const
```

### 10.348.3.5 GetConnectionInfo()

```
const ULConnectionInfo& gdc::network::ULConnection::GetConnectionInfo ( ) const
```

### 10.348.3.6 GetMaxPDUSize()

```
uint32_t gdc::network::ULConnection::GetMaxPDUSize ( ) const
```

### 10.348.3.7 GetPresentationContextACByID()

```
const PresentationContextAC* gdc::network::ULConnection::GetPresentationContextACByID (   
    uint8_t id ) const
```

### 10.348.3.8 GetPresentationContextIDFromPresentationContext()

```
uint8_t gdc::network::ULConnection::GetPresentationContextIDFromPresentationContext (   
    PresentationContextRQ const & pc ) const
```

return 0 upon error

### 10.348.3.9 GetPresentationContextRQByID()

```
const PresentationContextRQ* gdcm::network::ULConnection::GetPresentationContextRQByID (
    uint8_t id ) const
```

### 10.348.3.10 GetPresentationContexts()

```
std::vector<PresentationContextRQ> const& gdcm::network::ULConnection::GetPresentationContexts (
) const
```

### 10.348.3.11 GetProtocol()

```
std::iostream* gdcm::network::ULConnection::GetProtocol ( )
```

### 10.348.3.12 GetState()

```
EStateID gdcm::network::ULConnection::GetState ( ) const
```

### 10.348.3.13 GetTimer()

```
ARTIMTimer& gdcm::network::ULConnection::GetTimer ( )
```

### 10.348.3.14 InitializeConnection()

```
bool gdcm::network::ULConnection::InitializeConnection ( )
```

used to establish scu connections

### 10.348.3.15 InitializeIncomingConnection()

```
bool gdcM::network::ULConnection::InitializeIncomingConnection ( )
```

used to establish scp connections

### 10.348.3.16 operator=()

```
void gdcM::network::ULConnection::operator= (
    const ULConnection & ) [delete]
```

### 10.348.3.17 SetMaxPDUSize()

```
void gdcM::network::ULConnection::SetMaxPDUSize (
    uint32_t inSize )
```

### 10.348.3.18 SetPresentationContexts() [1/2]

```
void gdcM::network::ULConnection::SetPresentationContexts (
    const std::vector< PresentationContext > & inContexts )
```

### 10.348.3.19 SetPresentationContexts() [2/2]

```
void gdcM::network::ULConnection::SetPresentationContexts (
    const std::vector< PresentationContextRQ > & inContexts )
```

### 10.348.3.20 SetState()

```
void gdcM::network::ULConnection::SetState (
    const EStateID & inState )
```

### 10.348.3.21 StopProtocol()

```
void gdcm::network::ULConnection::StopProtocol ( )
```

## 10.348.4 Friends And Related Function Documentation

### 10.348.4.1 ULActionAE6

```
friend class ULActionAE6 [friend]
```

### 10.348.4.2 ULConnectionManager

```
friend class ULConnectionManager [friend]
```

The documentation for this class was generated from the following file:

- [gdcmULConnection.h](#)

## 10.349 gdcm::network::ULConnectionCallback Class Reference

```
#include <gdcmULConnectionCallback.h>
```

Inheritance diagram for gdcm::network::ULConnectionCallback:

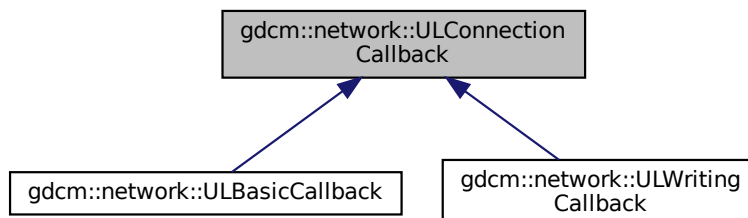

## Public Member Functions

- [ULConnectionCallback](#) ()
- virtual [~ULConnectionCallback](#) ()=default
- bool [DataSetHandles](#) () const
- virtual void [HandleDataSet](#) (const [DataSet](#) &inDataSet)=0
- virtual void [HandleResponse](#) (const [DataSet](#) &inDataSet)=0
- void [ResetHandledDataSet](#) ()
- void [SetImplicitFlag](#) (const bool imp)

## Protected Member Functions

- void [DataSetHandled](#) ()

## Protected Attributes

- bool [mImplicit](#)

### 10.349.1 Detailed Description

When a dataset comes back from a query/move/etc, the result can either be stored entirely in memory, or could be stored on disk. This class provides a mechanism to indicate what the [ULConnectionManager](#) should do with datasets that are produced through query results. The [ULConnectionManager](#) will call the [HandleDataSet](#) function during the course of receiving datasets. Particular implementations should fill in what that function does, including updating progress, etc. NOTE: since `cmove` requires that multiple event loops be employed, the callback function MUST set `mHandledData` ← Set to true. otherwise, the `cmove` event loop handler will not know data was received, and proceed to end the loop prematurely.

### 10.349.2 Constructor & Destructor Documentation

#### 10.349.2.1 [ULConnectionCallback](#)()

```
gdcm::network::ULConnectionCallback::ULConnectionCallback ( ) [inline]
```

#### 10.349.2.2 [~ULConnectionCallback](#)()

```
virtual gdcm::network::ULConnectionCallback::~~ULConnectionCallback ( ) [virtual], [default]
```



## 10.349.3 Member Function Documentation

### 10.349.3.1 DataSetHandled()

```
void gdcm::network::ULConnectionCallback::DataSetHandled ( ) [inline], [protected]
```

### 10.349.3.2 DataSetHandles()

```
bool gdcm::network::ULConnectionCallback::DataSetHandles ( ) const [inline]
```

### 10.349.3.3 HandleDataSet()

```
virtual void gdcm::network::ULConnectionCallback::HandleDataSet (
    const DataSet & inDataSet ) [pure virtual]
```

Implemented in [gdcm::network::ULWritingCallback](#), and [gdcm::network::ULBasicCallback](#).

### 10.349.3.4 HandleResponse()

```
virtual void gdcm::network::ULConnectionCallback::HandleResponse (
    const DataSet & inDataSet ) [pure virtual]
```

Implemented in [gdcm::network::ULWritingCallback](#), and [gdcm::network::ULBasicCallback](#).

### 10.349.3.5 ResetHandledDataSet()

```
void gdcm::network::ULConnectionCallback::ResetHandledDataSet ( ) [inline]
```

### 10.349.3.6 SetImplicitFlag()

```
void gdcm::network::ULConnectionCallback::SetImplicitFlag (
    const bool imp ) [inline]
```

## 10.349.4 Member Data Documentation

### 10.349.4.1 mImplicit

```
bool gdcmm::network::ULConnectionCallback::mImplicit [protected]
```

The documentation for this class was generated from the following file:

- [gdcmmULConnectionCallback.h](#)

## 10.350 gdcmm::network::ULConnectionInfo Class Reference

[ULConnectionInfo](#).

```
#include <gdcmmULConnectionInfo.h>
```

### Public Member Functions

- [ULConnectionInfo](#) ()
- const char \* [GetCalledAETitle](#) () const
- std::string [GetCalledComputerName](#) () const
- unsigned long [GetCalledIPAddress](#) () const
- int [GetCalledIPPort](#) () const
- const char \* [GetCallingAETitle](#) () const
- unsigned long [GetMaxPDULength](#) () const
- bool [Initialize](#) ([UserInformation](#) const &inUserInformation, const char \*inCalledAETitle, const char \*inCallingAETitle, unsigned long inCalledIPAddress, int inCalledIPPort, std::string inCalledComputerName)
- void [SetMaxPDULength](#) (unsigned long inMaxPDULength)

### 10.350.1 Detailed Description

[ULConnectionInfo](#).

this class contains all the information about a particular connection as established by the user. That is, it's: User Information Calling AE Title Called AE Title IP address/computer name IP Port A connection must be established with this information, that's subsequently placed into various primitives for actual communication.

### 10.350.2 Constructor & Destructor Documentation

### 10.350.2.1 ULConnectionInfo()

```
gdcm::network::ULConnectionInfo::ULConnectionInfo ( )
```

## 10.350.3 Member Function Documentation

### 10.350.3.1 GetCalledAETitle()

```
const char* gdcm::network::ULConnectionInfo::GetCalledAETitle ( ) const
```

### 10.350.3.2 GetCalledComputerName()

```
std::string gdcm::network::ULConnectionInfo::GetCalledComputerName ( ) const
```

### 10.350.3.3 GetCalledIPAddress()

```
unsigned long gdcm::network::ULConnectionInfo::GetCalledIPAddress ( ) const
```

### 10.350.3.4 GetCalledIPPort()

```
int gdcm::network::ULConnectionInfo::GetCalledIPPort ( ) const
```

### 10.350.3.5 GetCallingAETitle()

```
const char* gdcm::network::ULConnectionInfo::GetCallingAETitle ( ) const
```

### 10.350.3.6 GetMaxPDULength()

```
unsigned long gdcm::network::ULConnectionInfo::GetMaxPDULength ( ) const
```

### 10.350.3.7 Initialize()

```
bool gdcM::network::ULConnectionInfo::Initialize (
    UserInformation const & inUserInformation,
    const char * inCalledAETitle,
    const char * inCallingAETitle,
    unsigned long inCalledIPAddress,
    int inCalledIPPort,
    std::string inCalledComputerName )
```

### 10.350.3.8 SetMaxPDULength()

```
void gdcM::network::ULConnectionInfo::SetMaxPDULength (
    unsigned long inMaxPDULength )
```

The documentation for this class was generated from the following file:

- [gdcMULConnectionInfo.h](#)

## 10.351 gdcM::network::ULConnectionManager Class Reference

[ULConnectionManager](#).

```
#include <gdcMULConnectionManager.h>
```

Inheritance diagram for gdcM::network::ULConnectionManager:

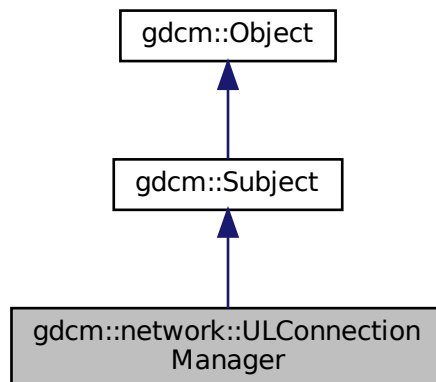

Collaboration diagram for gdcM::network::ULConnectionManager:

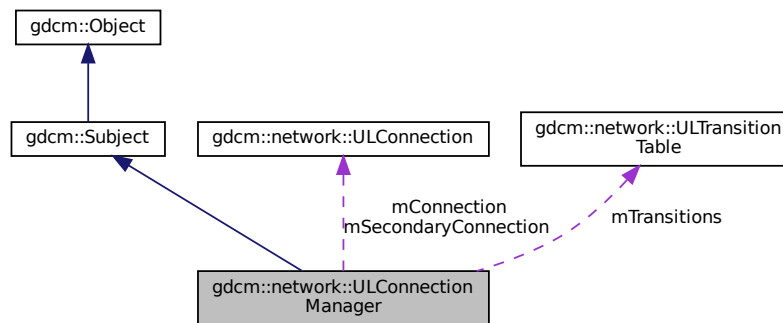

## Public Member Functions

- [ULConnectionManager](#) ()
- [~ULConnectionManager](#) () override
- bool [BreakConnection](#) (const double &inTimeout)
- void [BreakConnectionNow](#) ()
- bool [EstablishConnection](#) (const std::string &inAETitle, const std::string &inConnectAETitle, const std::string &inComputerName, long inIPAddress, uint16\_t inConnectPort, double inTimeout, std::vector< [PresentationContext](#) > const &pcVector)
- bool [EstablishConnectionMove](#) (const std::string &inAETitle, const std::string &inConnectAETitle, const std::string &inComputerName, long inIPAddress, uint16\_t inConnectPort, double inTimeout, uint16\_t inReturnPort, std::vector< [PresentationContext](#) > const &pcVector)
- std::vector< [PresentationDataValue](#) > [SendEcho](#) ()
- std::vector< [DataSet](#) > [SendFind](#) (const [BaseRootQuery](#) \*inRootQuery)
- void [SendFind](#) (const [BaseRootQuery](#) \*inRootQuery, [ULConnectionCallback](#) \*inCallback)
- std::vector< [DataSet](#) > [SendMove](#) (const [BaseRootQuery](#) \*inRootQuery)
- bool [SendMove](#) (const [BaseRootQuery](#) \*inRootQuery, [ULConnectionCallback](#) \*inCallback)  
*return false upon error*
- std::vector< [DataSet](#) > [SendNAction](#) (const [BaseQuery](#) \*inQuery)
- void [SendNAction](#) (const [BaseQuery](#) \*inQuery, [ULConnectionCallback](#) \*inCallback)
- std::vector< [DataSet](#) > [SendNCreate](#) (const [BaseQuery](#) \*inQuery)
- void [SendNCreate](#) (const [BaseQuery](#) \*inQuery, [ULConnectionCallback](#) \*inCallback)
- std::vector< [DataSet](#) > [SendNDelete](#) (const [BaseQuery](#) \*inQuery)
- void [SendNDelete](#) (const [BaseQuery](#) \*inQuery, [ULConnectionCallback](#) \*inCallback)
- std::vector< [DataSet](#) > [SendNEventReport](#) (const [BaseQuery](#) \*inQuery)
- void [SendNEventReport](#) (const [BaseQuery](#) \*inQuery, [ULConnectionCallback](#) \*inCallback)
- std::vector< [DataSet](#) > [SendNGet](#) (const [BaseQuery](#) \*inQuery)
- void [SendNGet](#) (const [BaseQuery](#) \*inQuery, [ULConnectionCallback](#) \*inCallback)
- std::vector< [DataSet](#) > [SendNSet](#) (const [BaseQuery](#) \*inQuery)
- void [SendNSet](#) (const [BaseQuery](#) \*inQuery, [ULConnectionCallback](#) \*inCallback)
- std::vector< [DataSet](#) > [SendStore](#) (const [File](#) &file, std::istream \*pStream=nullptr, std::streampos dataSetOffset=0)
- void [SendStore](#) (const [File](#) &file, [ULConnectionCallback](#) \*inCallback, std::istream \*pStream=nullptr, std::streampos dataSetOffset=0)  
*callback based API*

## Protected Member Functions

- [ULConnectionManager](#) (const [ULConnectionManager](#) &inCM)
- [EStateID RunEventLoop](#) ([ULEvent](#) &inEvent, [ULConnection](#) \*inWhichConnection, [ULConnectionCallback](#) \*in←→ Callback, const bool &startWaiting)
- [EStateID RunMoveEventLoop](#) ([ULEvent](#) &inEvent, [ULConnectionCallback](#) \*inCallback)

## Protected Attributes

- [ULConnection](#) \* mConnection
- [ULConnection](#) \* mSecondaryConnection
- [ULTransitionTable](#) mTransitions

### 10.351.1 Detailed Description

[ULConnectionManager](#).

The [ULConnectionManager](#) performs actions on the [ULConnection](#) given inputs from the user and from the state of what's going on around the connection (ie, timeouts of the ARTIM timer, responses from the peer across the connection, etc).

Its inputs are ULEvents, and it performs ULActions.

### 10.351.2 Constructor & Destructor Documentation

#### 10.351.2.1 [ULConnectionManager\(\)](#) [1/2]

```
gdcmm::network::ULConnectionManager::ULConnectionManager (
    const ULConnectionManager & inCM ) [protected]
```

#### 10.351.2.2 [ULConnectionManager\(\)](#) [2/2]

```
gdcmm::network::ULConnectionManager::ULConnectionManager ( )
```

#### 10.351.2.3 [~ULConnectionManager\(\)](#)

```
gdcmm::network::ULConnectionManager::~~ULConnectionManager ( ) [override]
```

## 10.351.3 Member Function Documentation

### 10.351.3.1 BreakConnection()

```
bool gdcmm::network::ULConnectionManager::BreakConnection (
    const double & inTimeout )
```

### 10.351.3.2 BreakConnectionNow()

```
void gdcmm::network::ULConnectionManager::BreakConnectionNow ( )
```

### 10.351.3.3 EstablishConnection()

```
bool gdcmm::network::ULConnectionManager::EstablishConnection (
    const std::string & inAETitle,
    const std::string & inConnectAETitle,
    const std::string & inComputerName,
    long inIPAddress,
    uint16_t inConnectPort,
    double inTimeout,
    std::vector< PresentationContext > const & pcVector )
```

returns true if a connection of the given AETitle (ie, 'this' program) is able to connect to the given AETitle and Port in a certain amount of time providing the connection type will establish the proper exchange syntax with a server; if a different functionality is required, a different connection should be established. returns false if the connection type is 'move'— have to give a return port for move to work as specified.

### 10.351.3.4 EstablishConnectionMove()

```
bool gdcmm::network::ULConnectionManager::EstablishConnectionMove (
    const std::string & inAETitle,
    const std::string & inConnectAETitle,
    const std::string & inComputerName,
    long inIPAddress,
    uint16_t inConnectPort,
    double inTimeout,
    uint16_t inReturnPort,
    std::vector< PresentationContext > const & pcVector )
```

returns true for above reasons, but contains the special 'move' port

### 10.351.3.5 RunEventLoop()

```
EStateID gdcM::network::ULConnectionManager::RunEventLoop (
    ULEvent & inEvent,
    ULConnection * inWhichConnection,
    ULConnectionCallback * inCallback,
    const bool & startWaiting ) [protected]
```

### 10.351.3.6 RunMoveEventLoop()

```
EStateID gdcM::network::ULConnectionManager::RunMoveEventLoop (
    ULEvent & inEvent,
    ULConnectionCallback * inCallback ) [protected]
```

### 10.351.3.7 SendEcho()

```
std::vector<PresentationDataValue> gdcM::network::ULConnectionManager::SendEcho ( )
```

### 10.351.3.8 SendFind() [1/2]

```
std::vector<DataSet> gdcM::network::ULConnectionManager::SendFind (
    const BaseRootQuery * inRootQuery )
```

### 10.351.3.9 SendFind() [2/2]

```
void gdcM::network::ULConnectionManager::SendFind (
    const BaseRootQuery * inRootQuery,
    ULConnectionCallback * inCallback )
```

### 10.351.3.10 SendMove() [1/2]

```
std::vector<DataSet> gdcM::network::ULConnectionManager::SendMove (
    const BaseRootQuery * inRootQuery )
```



**10.351.3.11 SendMove()** [2/2]

```
bool gdcm::network::ULConnectionManager::SendMove (
    const BaseRootQuery * inRootQuery,
    ULConnectionCallback * inCallback )
```

return false upon error

**10.351.3.12 SendNAction()** [1/2]

```
std::vector<DataSet> gdcm::network::ULConnectionManager::SendNAction (
    const BaseQuery * inQuery )
```

**10.351.3.13 SendNAction()** [2/2]

```
void gdcm::network::ULConnectionManager::SendNAction (
    const BaseQuery * inQuery,
    ULConnectionCallback * inCallback )
```

**10.351.3.14 SendNCreate()** [1/2]

```
std::vector<DataSet> gdcm::network::ULConnectionManager::SendNCreate (
    const BaseQuery * inQuery )
```

**10.351.3.15 SendNCreate()** [2/2]

```
void gdcm::network::ULConnectionManager::SendNCreate (
    const BaseQuery * inQuery,
    ULConnectionCallback * inCallback )
```

**10.351.3.16 SendNDelete()** [1/2]

```
std::vector<DataSet> gdcm::network::ULConnectionManager::SendNDelete (
    const BaseQuery * inQuery )
```

**10.351.3.17 SendNDelete()** [2/2]

```
void gdcM::network::ULConnectionManager::SendNDelete (
    const BaseQuery * inQuery,
    ULConnectionCallback * inCallback )
```

**10.351.3.18 SendNEventReport()** [1/2]

```
std::vector<DataSet> gdcM::network::ULConnectionManager::SendNEventReport (
    const BaseQuery * inQuery )
```

**10.351.3.19 SendNEventReport()** [2/2]

```
void gdcM::network::ULConnectionManager::SendNEventReport (
    const BaseQuery * inQuery,
    ULConnectionCallback * inCallback )
```

**10.351.3.20 SendNGet()** [1/2]

```
std::vector<DataSet> gdcM::network::ULConnectionManager::SendNGet (
    const BaseQuery * inQuery )
```

**10.351.3.21 SendNGet()** [2/2]

```
void gdcM::network::ULConnectionManager::SendNGet (
    const BaseQuery * inQuery,
    ULConnectionCallback * inCallback )
```

**10.351.3.22 SendNSet()** [1/2]

```
std::vector<DataSet> gdcM::network::ULConnectionManager::SendNSet (
    const BaseQuery * inQuery )
```

### 10.351.3.23 SendNSet() [2/2]

```
void gdcmm::network::ULConnectionManager::SendNSet (
    const BaseQuery * inQuery,
    ULConnectionCallback * inCallback )
```

### 10.351.3.24 SendStore() [1/2]

```
std::vector<DataSet> gdcmm::network::ULConnectionManager::SendStore (
    const File & file,
    std::istream * pStream = nullptr,
    std::streampos dataSetOffset = 0 )
```

### 10.351.3.25 SendStore() [2/2]

```
void gdcmm::network::ULConnectionManager::SendStore (
    const File & file,
    ULConnectionCallback * inCallback,
    std::istream * pStream = nullptr,
    std::streampos dataSetOffset = 0 )
```

callback based API

## 10.351.4 Member Data Documentation

### 10.351.4.1 mConnection

[ULConnection](#)\* gdcmm::network::ULConnectionManager::mConnection [protected]

### 10.351.4.2 mSecondaryConnection

[ULConnection](#)\* gdcmm::network::ULConnectionManager::mSecondaryConnection [protected]

### 10.351.4.3 mTransitions

```
ULTransitionTable gdcmm::network::ULConnectionManager::mTransitions [protected]
```

The documentation for this class was generated from the following file:

- [gdcmmULConnectionManager.h](#)

## 10.352 gdcmm::network::ULEvent Class Reference

[ULEvent](#).

```
#include <gdcmmULEvent.h>
```

### Public Member Functions

- [ULEvent](#) (const [EEventID](#) &inEventID, [BasePDU](#) \*inBasePDU, std::istream \*iStream=nullptr, std::streampos posDataSet=0)
- [ULEvent](#) (const [EEventID](#) &inEventID, std::vector< [BasePDU](#) \* > inBasePDU, std::istream \*iStream=nullptr, std::streampos posDataSet=0)
- [~ULEvent](#) ()
- std::streampos [GetDataSetPos](#) () const
- [EEventID](#) [GetEvent](#) () const
- std::istream \* [GetStream](#) () const
- std::vector< [BasePDU](#) \* > const & [GetPDUs](#) () const
- void [SetEvent](#) (const [EEventID](#) &inEvent)
- void [SetPDU](#) (std::vector< [BasePDU](#) \* > const &inPDU)

### 10.352.1 Detailed Description

[ULEvent](#).

base class for network events.

An event consists of the event ID and the data associated with that event.

Note that once a PDU is created, it is now the responsibility of the associated event to destroy it!

### 10.352.2 Constructor & Destructor Documentation

### 10.352.2.1 ULEvent() [1/2]

```
gdcn::network::ULEvent::ULEvent (
    const EEventID & inEventID,
    std::vector< BasePDU * > inBasePDU,
    std::istream * iStream = nullptr,
    std::streampos posDataSet = 0 ) [inline]
```

### 10.352.2.2 ULEvent() [2/2]

```
gdcn::network::ULEvent::ULEvent (
    const EEventID & inEventID,
    BasePDU * inBasePDU,
    std::istream * iStream = nullptr,
    std::streampos posDataSet = 0 ) [inline]
```

### 10.352.2.3 ~ULEvent()

```
gdcn::network::ULEvent::~~ULEvent ( ) [inline]
```

## 10.352.3 Member Function Documentation

### 10.352.3.1 GetDataSetPos()

```
std::streampos gdcn::network::ULEvent::GetDataSetPos ( ) const [inline]
```

### 10.352.3.2 GetEvent()

```
EEventID gdcn::network::ULEvent::GetEvent ( ) const [inline]
```

### 10.352.3.3 GetIStream()

```
std::istream* gdcn::network::ULEvent::GetIStream ( ) const [inline]
```

### 10.352.3.4 GetPDUs()

```
std::vector<BasePDU*> const& gdcn::network::ULEvent::GetPDUs ( ) const [inline]
```

### 10.352.3.5 SetEvent()

```
void gdcn::network::ULEvent::SetEvent (
    const EEventID & inEvent ) [inline]
```

### 10.352.3.6 SetPDU()

```
void gdcn::network::ULEvent::SetPDU (
    std::vector< BasePDU * > const & inPDU ) [inline]
```

The documentation for this class was generated from the following file:

- [gdcnULEvent.h](#)

## 10.353 gdcn::network::ULTransitionTable Class Reference

[ULTransitionTable](#) The transition table of all the ULEvents, new ULActions, and ULStates.

```
#include <gdcnULTransitionTable.h>
```

### Public Member Functions

- [ULTransitionTable](#) ()
- void [HandleEvent](#) ([Subject](#) \*s, [ULEvent](#) &inEvent, [ULConnection](#) &inConnection, bool &outWaitingForEvent, [EEventID](#) &outRaisedEvent) const
- void [PrintTable](#) () const

### 10.353.1 Detailed Description

[ULTransitionTable](#) The transition table of all the ULEvents, new ULActions, and ULStates.

Based roughly on the solutions in `player2.cpp` in the boost examples and this so question: <http://stackoverflow.com/questions/1647631/c-state-machine-design>

The transition table is constructed of `TableRows`. Each row is based on an event, and an event handler in the `TransitionTable` object takes a given event, and then finds the given row.

Then, given the current state of the connection, determines the appropriate action to take and then the state to transition to next.

## 10.353.2 Constructor & Destructor Documentation

### 10.353.2.1 ULTransitionTable()

```
gdcm::network::ULTransitionTable::ULTransitionTable ( )
```

## 10.353.3 Member Function Documentation

### 10.353.3.1 HandleEvent()

```
void gdcm::network::ULTransitionTable::HandleEvent (
    Subject * s,
    ULEvent & inEvent,
    ULConnection & inConnection,
    bool & outWaitingForEvent,
    EEventID & outRaisedEvent ) const
```

### 10.353.3.2 PrintTable()

```
void gdcm::network::ULTransitionTable::PrintTable ( ) const
```

The documentation for this class was generated from the following file:

- [gdcmULTransitionTable.h](#)

## 10.354 gdcm::network::ULWritingCallback Class Reference

```
#include <gdcmULWritingCallback.h>
```

Inheritance diagram for gdcm::network::ULWritingCallback:

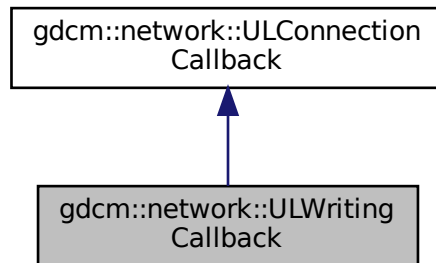

Collaboration diagram for gdcm::network::ULWritingCallback:

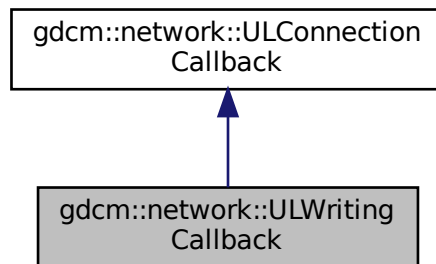

### Public Member Functions

- [ULWritingCallback](#) ()=default
- [~ULWritingCallback](#) () override=default
- void [HandleDataSet](#) (const [DataSet](#) &inDataSet) override
- void [HandleResponse](#) (const [DataSet](#) &inDataSet) override
- void [SetDirectory](#) (const std::string &inDirectoryName)

*provide the directory into which all files are written.*



## Additional Inherited Members

### 10.354.1 Constructor & Destructor Documentation

#### 10.354.1.1 ULWritingCallback()

```
gdcm::network::ULWritingCallback::ULWritingCallback ( ) [default]
```

#### 10.354.1.2 ~ULWritingCallback()

```
gdcm::network::ULWritingCallback::~ULWritingCallback ( ) [override], [default]
```

### 10.354.2 Member Function Documentation

#### 10.354.2.1 HandleDataSet()

```
void gdcm::network::ULWritingCallback::HandleDataSet (
    const DataSet & inDataSet ) [override], [virtual]
```

Implements [gdcm::network::ULConnectionCallback](#).

#### 10.354.2.2 HandleResponse()

```
void gdcm::network::ULWritingCallback::HandleResponse (
    const DataSet & inDataSet ) [override], [virtual]
```

Implements [gdcm::network::ULConnectionCallback](#).

### 10.354.2.3 SetDirectory()

```
void gdcM::network::ULWritingCallback::SetDirectory (
    const std::string & inDirectoryName ) [inline]
```

provide the directory into which all files are written.

The documentation for this class was generated from the following file:

- [gdcMULWritingCallback.h](#)

## 10.355 gdcM::UNExplicitDataElement Class Reference

Class to read/write a [DataElement](#) as UNExplicit Data [Element](#).

```
#include <gdcMUNExplicitDataElement.h>
```

Inheritance diagram for gdcM::UNExplicitDataElement:

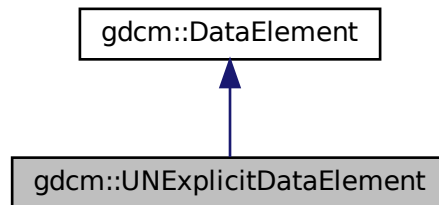

Collaboration diagram for gdcM::UNExplicitDataElement:

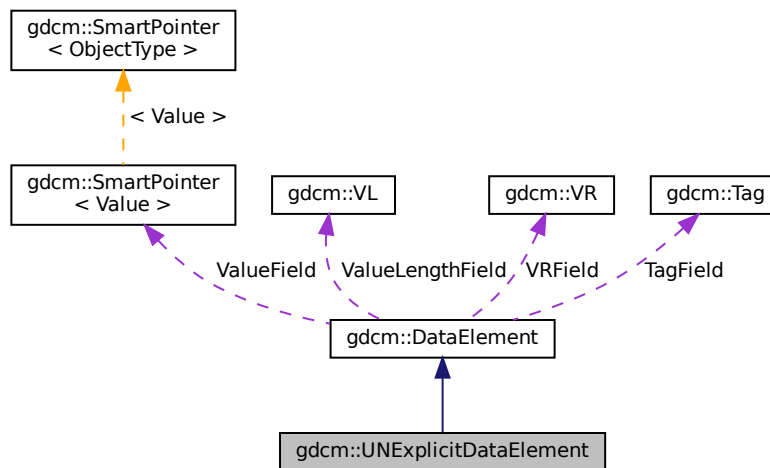

## Public Member Functions

- [VL GetLength](#) () const
- template<typename TSwap >  
std::istream & [Read](#) (std::istream &is)
- template<typename TSwap >  
std::istream & [ReadPreValue](#) (std::istream &is)
- template<typename TSwap >  
std::istream & [ReadValue](#) (std::istream &is, bool readvalues=true)
- template<typename TSwap >  
std::istream & [ReadWithLength](#) (std::istream &is, [VL](#) &length)

## Additional Inherited Members

### 10.355.1 Detailed Description

Class to read/write a [DataElement](#) as UNExplicit Data [Element](#).

#### Note

bla

### 10.355.2 Member Function Documentation

### 10.355.2.1 GetLength()

```
VL gdcM::UNExplicitDataElement::GetLength ( ) const
```

### 10.355.2.2 Read()

```
template<typename TSwap >  
std::istream& gdcM::UNExplicitDataElement::Read (  
    std::istream & is )
```

### 10.355.2.3 ReadPreValue()

```
template<typename TSwap >  
std::istream& gdcM::UNExplicitDataElement::ReadPreValue (  
    std::istream & is )
```

### 10.355.2.4 ReadValue()

```
template<typename TSwap >  
std::istream& gdcM::UNExplicitDataElement::ReadValue (  
    std::istream & is,  
    bool readvalues = true )
```

### 10.355.2.5 ReadWithLength()

```
template<typename TSwap >  
std::istream& gdcM::UNExplicitDataElement::ReadWithLength (  
    std::istream & is,  
    VL & length )
```

The documentation for this class was generated from the following file:

- [gdcMUNExplicitDataElement.h](#)

## 10.356 gdcM::UNExplicitImplicitDataElement Class Reference

Class to read/write a [DataElement](#) as ExplicitImplicit Data [Element](#).

```
#include <gdcMUNExplicitImplicitDataElement.h>
```

Inheritance diagram for gdcM::UNExplicitImplicitDataElement:

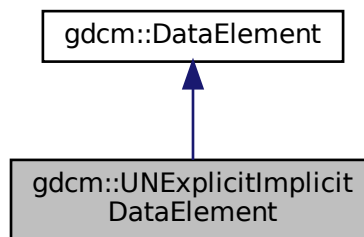

Collaboration diagram for gdcM::UNExplicitImplicitDataElement:

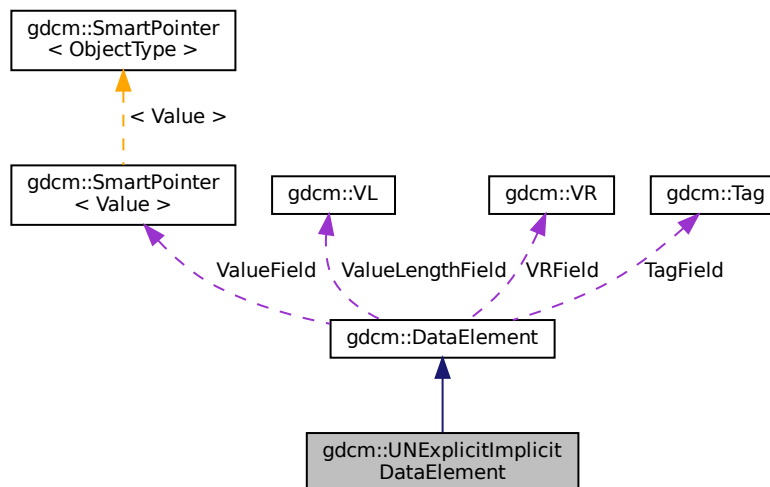

### Public Member Functions

- [VL GetLength](#) () const

- `template<typename TSwap >`  
`std::istream & Read (std::istream &is)`
- `template<typename TSwap >`  
`std::istream & ReadPreValue (std::istream &is)`
- `template<typename TSwap >`  
`std::istream & ReadValue (std::istream &is)`

## Additional Inherited Members

### 10.356.1 Detailed Description

Class to read/write a [DataElement](#) as ExplicitImplicit Data [Element](#).

This class gather two known bugs:

1. GDCM 1.2.0 would rewrite [VR=UN Value](#) Length on 2 bytes instead of 4 bytes
2. GDCM 1.2.0 would also rewrite [DataElement](#) as Implicit when the [VR](#) would not be known this would only happen in some very rare cases. gdcM 2.X design could handle bug #1 or #2 exclusively, this class can now handle file which have both issues. See: `gdcMData/TheralysGDCM120Bug.dcm`

### 10.356.2 Member Function Documentation

#### 10.356.2.1 GetLength()

```
VL gdcM::UNExplicitImplicitDataElement::GetLength ( ) const
```

#### 10.356.2.2 Read()

```
template<typename TSwap >  
std::istream& gdcM::UNExplicitImplicitDataElement::Read (  
    std::istream & is )
```

#### 10.356.2.3 ReadPreValue()

```
template<typename TSwap >  
std::istream& gdcM::UNExplicitImplicitDataElement::ReadPreValue (  
    std::istream & is )
```

### 10.356.2.4 ReadValue()

```
template<typename TSwap >
std::istream& gdcm::UNExplicitImplicitDataElement::ReadValue (
    std::istream & is )
```

The documentation for this class was generated from the following file:

- [gdcmUNExplicitImplicitDataElement.h](#)

## 10.357 gdcm::Unpacker12Bits Class Reference

Pack/Unpack 12 bits pixel into 16bits.

```
#include <gdcmUnpacker12Bits.h>
```

### Static Public Member Functions

- static bool [Pack](#) (char \*out, const char \*in, size\_t n)
- static bool [Unpack](#) (char \*out, const char \*in, size\_t n)

### 10.357.1 Detailed Description

Pack/Unpack 12 bits pixel into 16bits.

- You can only pack an even number of 16bits, which means a multiple of 4 (expressed in bytes)
- You can only unpack a multiple of 3 bytes

This class has no purpose in general purpose DICOM implementation. However to be able to cope with some early ACR-NEMA file generated by a well-known private vendor, one would need to unpack 12bits Stored Pixel [Value](#) into a more standard 16bits Stored Pixel [Value](#).

See also

[Rescaler](#)

### 10.357.2 Member Function Documentation

### 10.357.2.1 Pack()

```
static bool gdcM::Unpacker12Bits::Pack (  
    char * out,  
    const char * in,  
    size_t n ) [static]
```

Pack an array of 16bits where all values are 12bits into a pack form. n is the length in bytes of array in, out will be a fake 8bits array of size  $(n / 2) * 3$

### 10.357.2.2 Unpack()

```
static bool gdcM::Unpacker12Bits::Unpack (  
    char * out,  
    const char * in,  
    size_t n ) [static]
```

Unpack an array of 'packed' 12bits data into a more conventional 16bits array. n is the length in bytes of array in, out will be a 16bits array of size  $(n / 3) * 2$

The documentation for this class was generated from the following file:

- [gdcMUnpacker12Bits.h](#)

## 10.358 gdcM::Usage Class Reference

[Usage.](#)

```
#include <gdcMUsage.h>
```

### Public Types

- enum [UsageType](#) {  
    [Mandatory](#) ,  
    [Conditional](#) ,  
    [UserOption](#) ,  
    [Invalid](#) }

### Public Member Functions

- [Usage](#) ([UsageType](#) type=[Invalid](#))
- [operator UsageType](#) () const



## Static Public Member Functions

- static const char \* [GetUsageString](#) ([UsageType](#) type)
- static [UsageType](#) [GetUsageType](#) (const char \*type)

## Friends

- std::ostream & [operator<<](#) (std::ostream &os, const [Usage](#) &vr)

## 10.358.1 Detailed Description

[Usage](#).

### Note

A.1.3 [IOD Module Table](#) and Functional Group [Macro Table](#) This Section of each [IOD](#) defines in a tabular form the [Modules](#) comprising the [IOD](#). The following information must be specified for each [Module](#) in the table:

- The name of the [Module](#) or Functional Group
  - A reference to the Section in Annex C which defines the [Module](#) or Functional Group
  - The usage of the [Module](#) or Functional Group; whether it is:
    - Mandatory (see A.1.3.1) , abbreviated M
    - Conditional (see A.1.3.2) , abbreviated C
    - User Option (see A.1.3.3) , abbreviated U
- The [Modules](#) referenced are defined in Annex C. A.1.3.1 MANDATORY MODULES For each [IOD](#), Mandatory [Modules](#) shall be supported per the definitions, semantics and requirements defined in Annex C.

A.1.3.2 CONDITIONAL MODULES Conditional [Modules](#) are Mandatory [Modules](#) if specific conditions are met. If the specified conditions are not met, this [Module](#) shall not be supported; that is, no information defined in that [Module](#) shall be sent. A.1.3.3 USER OPTION MODULES User Option [Modules](#) may or may not be supported. If an optional [Module](#) is supported, the [Attribute](#) Types specified in the [Modules](#) in Annex C shall be supported.

## 10.358.2 Member Enumeration Documentation

### 10.358.2.1 UsageType

enum [gdcm::Usage::UsageType](#)

#### Enumerator

Mandatory	
Conditional	
UserOption	
Invalid	

## 10.358.3 Constructor & Destructor Documentation

### 10.358.3.1 Usage()

```
gdcM::Usage::Usage (
    UsageType type = Invalid ) [inline]
```

## 10.358.4 Member Function Documentation

### 10.358.4.1 GetUsageString()

```
static const char* gdcM::Usage::GetUsageString (
    UsageType type ) [static]
```

### 10.358.4.2 GetUsageType()

```
static UsageType gdcM::Usage::GetUsageType (
    const char * type ) [static]
```

### 10.358.4.3 operator UsageType()

```
gdcM::Usage::operator UsageType ( ) const [inline]
```

## 10.358.5 Friends And Related Function Documentation

### 10.358.5.1 operator<<

```
std::ostream& operator<< (
    std::ostream & os,
    const Usage & vr ) [friend]
```

The documentation for this class was generated from the following file:

- [gdcMUsage.h](#)

## 10.359 gdcM::UserEvent Class Reference

```
#include <gdcMEvent.h>
```

Inheritance diagram for gdcM::UserEvent:

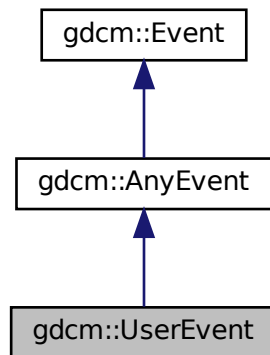

Collaboration diagram for gdcM::UserEvent:

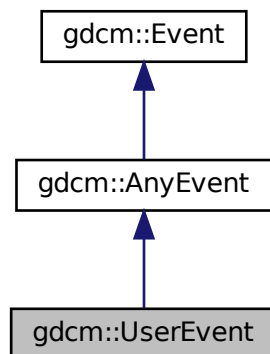

### Additional Inherited Members

The documentation for this class was generated from the following file:

- [gdcMEvent.h](#)

## 10.360 gdcm::network::UserInformation Class Reference

[UserInformation.](#)

```
#include <gdcmUserInformation.h>
```

### Public Member Functions

- [UserInformation](#) ()
- [UserInformation](#) (const [UserInformation](#) &)=delete
- [~UserInformation](#) ()
- void [AddRoleSelectionSub](#) ([RoleSelectionSub](#) const &r)
- void [AddSOPClassExtendedNegociationSub](#) ([SOPClassExtendedNegociationSub](#) const &s)
- [MaximumLengthSub](#) & [GetMaximumLengthSub](#) ()
- const [MaximumLengthSub](#) & [GetMaximumLengthSub](#) () const
- [UserInformation](#) & [operator=](#) (const [UserInformation](#) &)
- void [Print](#) (std::ostream &os) const
- std::istream & [Read](#) (std::istream &is)
- size\_t [Size](#) () const
- const std::ostream & [Write](#) (std::ostream &os) const

### 10.360.1 Detailed Description

[UserInformation.](#)

[Table 9-16](#) USER INFORMATION ITEM FIELDS

TODO what is the goal of :

[Table 9-20](#) USER INFORMATION ITEM FIELDS

### 10.360.2 Constructor & Destructor Documentation

#### 10.360.2.1 [UserInformation\(\)](#) [1/2]

```
gdcm::network::UserInformation::UserInformation ( )
```

#### 10.360.2.2 [~UserInformation\(\)](#)

```
gdcm::network::UserInformation::~~UserInformation ( )
```

### 10.360.2.3 UserInformation() [2/2]

```
gdcmm::network::UserInformation::UserInformation (  
    const UserInformation & ) [delete]
```

## 10.360.3 Member Function Documentation

### 10.360.3.1 AddRoleSelectionSub()

```
void gdcmm::network::UserInformation::AddRoleSelectionSub (  
    RoleSelectionSub const & r )
```

### 10.360.3.2 AddSOPClassExtendedNegociationSub()

```
void gdcmm::network::UserInformation::AddSOPClassExtendedNegociationSub (  
    SOPClassExtendedNegociationSub const & s )
```

### 10.360.3.3 GetMaximumLengthSub() [1/2]

```
MaximumLengthSub& gdcmm::network::UserInformation::GetMaximumLengthSub ( ) [inline]
```

### 10.360.3.4 GetMaximumLengthSub() [2/2]

```
const MaximumLengthSub& gdcmm::network::UserInformation::GetMaximumLengthSub ( ) const [inline]
```

### 10.360.3.5 operator=()

```
UserInformation& gdcmm::network::UserInformation::operator= (  
    const UserInformation & )
```

### 10.360.3.6 Print()

```
void gdcmm::network::UserInformation::Print (
    std::ostream & os ) const
```

### 10.360.3.7 Read()

```
std::istream& gdcmm::network::UserInformation::Read (
    std::istream & is )
```

### 10.360.3.8 Size()

```
size_t gdcmm::network::UserInformation::Size ( ) const
```

### 10.360.3.9 Write()

```
const std::ostream& gdcmm::network::UserInformation::Write (
    std::ostream & os ) const
```

The documentation for this class was generated from the following file:

- [gdcmmUserInformation.h](#)

## 10.361 gdcmm::UUIDGenerator Class Reference

Class for generating unique UUID.

```
#include <gdcmmUUIDGenerator.h>
```

### Public Member Functions

- const char \* [Generate](#) ()

### Static Public Member Functions

- static bool [IsValid](#) (const char \*uid)  
*Find out if the string is a valid UUID or not.*

### 10.361.1 Detailed Description

Class for generating unique UUID.

generate DCE 1.1 uid

### 10.361.2 Member Function Documentation

#### 10.361.2.1 Generate()

```
const char* gdcm::UUIDGenerator::Generate ( )
```

Return the generated uuid NOT THREAD SAFE

#### 10.361.2.2 IsValid()

```
static bool gdcm::UUIDGenerator::IsValid (
    const char * uid ) [static]
```

Find out if the string is a valid UUID or not.

The documentation for this class was generated from the following file:

- [gdcmUUIDGenerator.h](#)

## 10.362 gdcm::Validate Class Reference

[Validate](#) class.

```
#include <gdcmValidate.h>
```

Collaboration diagram for gdcm::Validate:

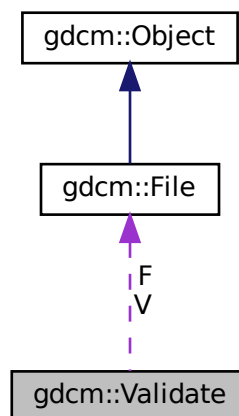

## Public Member Functions

- [Validate](#) ()
- [~Validate](#) ()
- const [File](#) & [GetValidatedFile](#) ()
- void [SetFile](#) ([File](#) const &f)
- void [Validation](#) ()

## Protected Attributes

- const [File](#) \* F
- [File](#) V

### 10.362.1 Detailed Description

[Validate](#) class.

### 10.362.2 Constructor & Destructor Documentation

#### 10.362.2.1 [Validate](#)()

```
gdcM::Validate::Validate ( )
```

#### 10.362.2.2 [~Validate](#)()

```
gdcM::Validate::~~Validate ( )
```

### 10.362.3 Member Function Documentation

#### 10.362.3.1 [GetValidatedFile](#)()

```
const File& gdcM::Validate::GetValidatedFile ( ) [inline]
```



### 10.362.3.2 SetFile()

```
void gdcm::Validate::SetFile (
    File const & f ) [inline]
```

### 10.362.3.3 Validation()

```
void gdcm::Validate::Validation ( )
```

## 10.362.4 Member Data Documentation

### 10.362.4.1 F

```
const File* gdcm::Validate::F [protected]
```

### 10.362.4.2 V

```
File gdcm::Validate::V [protected]
```

The documentation for this class was generated from the following file:

- [gdcmValidate.h](#)

## 10.363 gdcM::Value Class Reference

Class to represent the value of a Data [Element](#).

```
#include <gdcMValue.h>
```

Inheritance diagram for gdcM::Value:

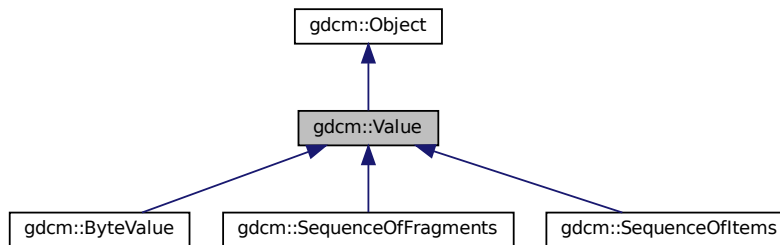

Collaboration diagram for gdcM::Value:

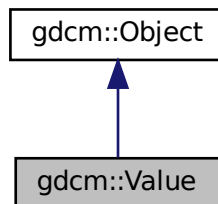

### Public Member Functions

- `Value ()`=default
- `~Value ()` override=default
- virtual void `Clear ()`=0
- virtual `VL GetLength ()` const =0
- virtual bool `operator== (const Value &val)` const =0
- virtual void `SetLength (VL l)`=0

### Protected Member Functions

- virtual void `SetLengthOnly (VL l)`

## Friends

- class [DataElement](#)

### 10.363.1 Detailed Description

Class to represent the value of a Data [Element](#).

#### Note

VALUE: A component of a [Value](#) Field. A [Value](#) Field may consist of one or more of these components.

### 10.363.2 Constructor & Destructor Documentation

#### 10.363.2.1 Value()

```
gdcm::Value::Value ( ) [default]
```

#### 10.363.2.2 ~Value()

```
gdcm::Value::~~Value ( ) [override], [default]
```

### 10.363.3 Member Function Documentation

#### 10.363.3.1 Clear()

```
virtual void gdcm::Value::Clear ( ) [pure virtual]
```

Implemented in [gdcm::SequenceOfItems](#), [gdcm::SequenceOfFragments](#), and [gdcm::ByteValue](#).

### 10.363.3.2 GetLength()

```
virtual VL gdcM::Value::GetLength ( ) const [pure virtual]
```

Implemented in [gdcM::SequenceOfItems](#), [gdcM::SequenceOfFragments](#), and [gdcM::ByteValue](#).

Referenced by [gdcM::DataSet::InsertDataElement\(\)](#), and [gdcM::DataElement::SetValue\(\)](#).

### 10.363.3.3 operator==( )

```
virtual bool gdcM::Value::operator==(
    const Value & val ) const [pure virtual]
```

Implemented in [gdcM::SequenceOfItems](#), [gdcM::SequenceOfFragments](#), and [gdcM::ByteValue](#).

### 10.363.3.4 SetLength()

```
virtual void gdcM::Value::SetLength (
    VL l ) [pure virtual]
```

Implemented in [gdcM::ByteValue](#), [gdcM::SequenceOfItems](#), and [gdcM::SequenceOfFragments](#).

### 10.363.3.5 SetLengthOnly()

```
virtual void gdcM::Value::SetLengthOnly (
    VL l ) [protected], [virtual]
```

Reimplemented in [gdcM::ByteValue](#).

## 10.363.4 Friends And Related Function Documentation

### 10.363.4.1 DataElement

```
friend class DataElement [friend]
```

The documentation for this class was generated from the following file:

- [gdcMValue.h](#)

## 10.364 `gdc::ValueIO< TDE, TSwap, TType >` Class Template Reference

Class to dispatch template calls.

```
#include <gdcValueIO.h>
```

### Static Public Member Functions

- static `std::istream & Read` (`std::istream &is`, `Value &v`, `bool readvalues`)
- static `const std::ostream & Write` (`std::ostream &os`, `const Value &v`)

### 10.364.1 Detailed Description

```
template<typename TDE, typename TSwap, typename TType = uint8_t>  
class gdc::ValueIO< TDE, TSwap, TType >
```

Class to dispatch template calls.

### 10.364.2 Member Function Documentation

#### 10.364.2.1 `Read()`

```
template<typename TDE , typename TSwap , typename TType = uint8_t>  
static std::istream& gdc::ValueIO< TDE, TSwap, TType >::Read (  
    std::istream & is,  
    Value & v,  
    bool readvalues ) [static]
```

#### 10.364.2.2 `Write()`

```
template<typename TDE , typename TSwap , typename TType = uint8_t>  
static const std::ostream& gdc::ValueIO< TDE, TSwap, TType >::Write (  
    std::ostream & os,  
    const Value & v ) [static]
```

The documentation for this class was generated from the following file:

- [gdcValueIO.h](#)

## 10.365 gdcM::MrProtocol::Vector3 Struct Reference

```
#include <gdcMmrProtocol.h>
```

### Public Attributes

- double [dCor](#)
- double [dSag](#)
- double [dTra](#)

### 10.365.1 Member Data Documentation

#### 10.365.1.1 dCor

```
double gdcM::MrProtocol::Vector3::dCor
```

#### 10.365.1.2 dSag

```
double gdcM::MrProtocol::Vector3::dSag
```

#### 10.365.1.3 dTra

```
double gdcM::MrProtocol::Vector3::dTra
```

The documentation for this struct was generated from the following file:

- [gdcMmrProtocol.h](#)

## 10.366 gdcM::Version Class Reference

major/minor and build version

```
#include <gdcMVersion.h>
```

## Public Member Functions

- [Version](#) ()=default
- [~Version](#) ()=default
- void [Print](#) (std::ostream &os=std::cout) const

## Static Public Member Functions

- static int [GetBuildVersion](#) ()
- static int [GetMajorVersion](#) ()
- static int [GetMinorVersion](#) ()
- static const char \* [GetVersion](#) ()

## Friends

- std::ostream & [operator<<](#) (std::ostream &\_os, const [Version](#) &v)

### 10.366.1 Detailed Description

major/minor and build version

### 10.366.2 Constructor & Destructor Documentation

#### 10.366.2.1 [Version\(\)](#)

```
gdcm::Version::Version ( ) [default]
```

#### 10.366.2.2 [~Version\(\)](#)

```
gdcm::Version::~~Version ( ) [default]
```

### 10.366.3 Member Function Documentation

### 10.366.3.1 GetBuildVersion()

```
static int gdcm::Version::GetBuildVersion ( ) [static]
```

### 10.366.3.2 GetMajorVersion()

```
static int gdcm::Version::GetMajorVersion ( ) [static]
```

### 10.366.3.3 GetMinorVersion()

```
static int gdcm::Version::GetMinorVersion ( ) [static]
```

### 10.366.3.4 GetVersion()

```
static const char* gdcm::Version::GetVersion ( ) [static]
```

### 10.366.3.5 Print()

```
void gdcm::Version::Print (
    std::ostream & os = std::cout ) const
```

## 10.366.4 Friends And Related Function Documentation

### 10.366.4.1 operator<<

```
std::ostream& operator<< (
    std::ostream & _os,
    const Version & v ) [friend]
```

The documentation for this class was generated from the following file:

- [gdcmVersion.h](#)



## 10.367 gdcm::VL Class Reference

Value Length.

```
#include <gdcmVL.h>
```

### Public Types

- typedef uint32\_t [Type](#)

### Public Member Functions

- [VL](#) (uint32\_t vl=0)
- [VL GetLength](#) () const
- bool [IsOdd](#) () const
  - Return whether or not the [VL](#) is odd or not.*
- bool [IsUndefined](#) () const
- [operator uint32\\_t](#) () const
- [VL & operator++](#) ()
- [VL operator++](#) (int)
- [VL & operator+=](#) ([VL](#) const &vl)
  - += operator*
- template<typename TSwap >  
std::istream & [Read](#) (std::istream &is)
- template<typename TSwap >  
std::istream & [Read16](#) (std::istream &is)
- void [SetToUndefined](#) ()
- template<typename TSwap >  
const std::ostream & [Write](#) (std::ostream &os) const
- template<typename TSwap >  
const std::ostream & [Write16](#) (std::ostream &os) const

### Static Public Member Functions

- static uint16\_t [GetVL16Max](#) ()
- static uint32\_t [GetVL32Max](#) ()

### Friends

- std::ostream & [operator<<](#) (std::ostream &os, const [VL](#) &vl)

### 10.367.1 Detailed Description

[Value](#) Length.

#### Warning

this is a 4bytes value ! Do not try to use it for 2bytes value length

#### Examples

[ReadAndDumpDICOMDIR2.cxx](#), and [rle2img.cxx](#).

### 10.367.2 Member Typedef Documentation

#### 10.367.2.1 Type

```
typedef uint32_t gdcM::VL::Type
```

### 10.367.3 Constructor & Destructor Documentation

#### 10.367.3.1 VL()

```
gdcM::VL::VL (
    uint32_t v1 = 0 ) [inline]
```

### 10.367.4 Member Function Documentation

#### 10.367.4.1 GetLength()

```
VL gdcM::VL::GetLength ( ) const [inline]
```

#### Examples

[ReadAndDumpDICOMDIR2.cxx](#).

Referenced by `gdcM::FileMetaInformation::GetFullLength()`, `gdcM::DataSet::GetLength()`, and `gdcM::Item::Write()`.

#### 10.367.4.2 GetVL16Max()

```
static uint16_t gdcv::VL::GetVL16Max ( ) [inline], [static]
```

#### 10.367.4.3 GetVL32Max()

```
static uint32_t gdcv::VL::GetVL32Max ( ) [inline], [static]
```

#### 10.367.4.4 IsOdd()

```
bool gdcv::VL::IsOdd ( ) const [inline]
```

Return whether or not the [VL](#) is odd or not.

#### 10.367.4.5 IsUndefined()

```
bool gdcv::VL::IsUndefined ( ) const [inline]
```

#### 10.367.4.6 operator uint32\_t()

```
gdcv::VL::operator uint32_t ( ) const [inline]
```

#### 10.367.4.7 operator++() [1/2]

```
VL& gdcv::VL::operator++ ( ) [inline]
```

#### 10.367.4.8 operator++() [2/2]

```
VL gdcv::VL::operator++ (
    int ) [inline]
```

#### 10.367.4.9 operator+=()

```
VL& gdcM::VL::operator+= (
    VL const & vl ) [inline]
```

+= operator

#### 10.367.4.10 Read()

```
template<typename TSwap >
std::istream& gdcM::VL::Read (
    std::istream & is ) [inline]
```

#### 10.367.4.11 Read16()

```
template<typename TSwap >
std::istream& gdcM::VL::Read16 (
    std::istream & is ) [inline]
```

#### 10.367.4.12 SetToUndefined()

```
void gdcM::VL::SetToUndefined ( ) [inline]
```

#### 10.367.4.13 Write()

```
template<typename TSwap >
const std::ostream& gdcM::VL::Write (
    std::ostream & os ) const [inline]
```

Referenced by `gdcM::Fragment::Write()`, `gdcM::Item::Write()`, `gdcM::SequenceOfFragments::Write()`, and `gdcM::SequenceOfItems::Write()`.

#### 10.367.4.14 Write16()

```
template<typename TSwap >
const std::ostream& gdcM::VL::Write16 (
    std::ostream & os ) const [inline]
```

## 10.367.5 Friends And Related Function Documentation

### 10.367.5.1 operator<<

```
std::ostream& operator<< (
    std::ostream & os,
    const VL & vl ) [friend]
```

The documentation for this class was generated from the following file:

- [gdcmVL.h](#)

## 10.368 gdcm::VM Class Reference

**Value** Multiplicity Looking at the DICOMV3 dict only there is very few cases: 1 2 3 4 5 6 8 16 24 1-2 1-3 1-8 1-32 1-99 1-n 2-2n 2-n 3-3n 3-n.

```
#include <gdcmVM.h>
```

### Public Types

- enum [VMType](#) {
  - [VM0](#) = 0 ,
  - [VM1](#) = 1 ,
  - [VM2](#) = 2 ,
  - [VM3](#) = 4 ,
  - [VM4](#) = 8 ,
  - [VM5](#) = 16 ,
  - [VM6](#) = 32 ,
  - [VM8](#) = 64 ,
  - [VM9](#) = 128 ,
  - [VM10](#) = 256 ,
  - [VM12](#) = 512 ,
  - [VM16](#) = 1024 ,
  - [VM18](#) = 2048 ,
  - [VM24](#) = 4096 ,
  - [VM28](#) = 8192 ,
  - [VM32](#) = 16384 ,
  - [VM35](#) = 32768 ,
  - [VM99](#) = 65536 ,
  - [VM256](#) = 131072 ,
  - [VM1\\_2](#) = VM1 | VM2 ,
  - [VM1\\_3](#) = VM1 | VM2 | VM3 ,
  - [VM1\\_4](#) = VM1 | VM2 | VM3 | VM4 ,
  - [VM1\\_5](#) = VM1 | VM2 | VM3 | VM4 | VM5 ,

```

VM1_8 = VM1 | VM2 | VM3 | VM4 | VM5 | VM6 | VM8 ,
VM1_32 = VM1 | VM2 | VM3 | VM4 | VM5 | VM6 | VM8 | VM9 | VM16 | VM24 | VM32 ,
VM1_99 = VM1 | VM2 | VM3 | VM4 | VM5 | VM6 | VM8 | VM9 | VM16 | VM24 | VM32 | VM99 ,
VM1_n = VM1 | VM2 | VM3 | VM4 | VM5 | VM6 | VM8 | VM9 | VM16 | VM24 | VM32 | VM99 | VM256 ,
VM2_2n = VM2 | VM4 | VM6 | VM8 | VM16 | VM24 | VM32 | VM256 ,
VM2_n = VM2 | VM3 | VM4 | VM5 | VM6 | VM8 | VM9 | VM16 | VM24 | VM32 | VM99 | VM256 ,
VM3_4 = VM3 | VM4 ,
VM3_3n = VM3 | VM6 | VM9 | VM24 | VM99 | VM256 ,
VM3_n = VM3 | VM4 | VM5 | VM6 | VM8 | VM9 | VM16 | VM24 | VM32 | VM99 | VM256 ,
VM4_4n = VM4 | VM16 | VM24 | VM32 | VM256 ,
VM6_6n = VM6 | VM12 | VM18 | VM24 ,
VM6_n = VM6 | VM8 | VM9 | VM16 | VM24 | VM32 | VM99 | VM256 ,
VM7_7n ,
VM30_30n ,
VM47_47n ,
VM_END = VM1_n + 1 }

```

## Public Member Functions

- [VM](#) ([VMType](#) type=[VM0](#))
- bool [Compatible](#) ([VM](#) const &vm) const
- unsigned int [GetLength](#) () const
- [operator VMType](#) () const

## Static Public Member Functions

- static [size\\_t](#) [GetNumberOfElementsFromArray](#) (const char \*array, [size\\_t](#) length)
- static const char \* [GetVMString](#) ([VMType](#) vm)
- static [VMType](#) [GetVMType](#) (const char \*vm)
- static [VMType](#) [GetVMTypeFromLength](#) ([size\\_t](#) length, unsigned int size)
- static bool [IsValid](#) (int vm1, [VMType](#) vm2)

## Static Protected Member Functions

- static unsigned int [GetIndex](#) ([VMType](#) vm)

## Friends

- [std::ostream](#) & [operator<<](#) ([std::ostream](#) &os, const [VM](#) &vm)

## 10.368.1 Detailed Description

**Value** Multiplicity Looking at the DICOMV3 dict only there is very few cases: 1 2 3 4 5 6 8 16 24 1-2 1-3 1-8 1-32 1-99 1-n 2-2n 2-n 3-3n 3-n.

Some private dict define some more: 4-4n 1-4 1-5 256 9 3-4

even more:

7-7n 10 18 12 35 47\_47n 30\_30n 28

6-6n

## 10.368.2 Member Enumeration Documentation

### 10.368.2.1 VMType

enum `gdcM::VM::VMType`

#### Enumerator

VM0	
VM1	
VM2	
VM3	
VM4	
VM5	
VM6	
VM8	
VM9	
VM10	
VM12	
VM16	
VM18	
VM24	
VM28	
VM32	
VM35	
VM99	
VM256	
VM1_2	
VM1_3	
VM1_4	
VM1_5	
VM1_8	
VM1_32	
VM1_99	
VM1_n	
VM2_2n	
VM2_n	
VM3_4	
VM3_3n	
VM3_n	
VM4_4n	
VM6_6n	
VM6_n	
VM7_7n	
VM30_30n	
VM47_47n	
VM_END	

### 10.368.3 Constructor & Destructor Documentation

#### 10.368.3.1 VM()

```
gdcM::VM::VM (
    VMType type = VM0 ) [inline]
```

### 10.368.4 Member Function Documentation

#### 10.368.4.1 Compatible()

```
bool gdcM::VM::Compatible (
    VM const & vm ) const
```

WARNING: Implementation deficiency The Compatible function is poorly implemented, the reference vm should be coming from the dictionary, while the passed in value is the value guess from the file.

#### 10.368.4.2 GetIndex()

```
static unsigned int gdcM::VM::GetIndex (
    VMType vm ) [static], [protected]
```

#### 10.368.4.3 GetLength()

```
unsigned int gdcM::VM::GetLength ( ) const
```

#### 10.368.4.4 GetNumberOfElementsFromArray()

```
static size_t gdcM::VM::GetNumberOfElementsFromArray (
    const char * array,
    size_t length ) [static]
```



#### 10.368.4.5 GetVMString()

```
static const char* gdcm::VM::GetVMString (
    VMType vm ) [static]
```

Return the string as written in the official DICOM dict from a custom enum type

#### 10.368.4.6 GetVMType()

```
static VMType gdcm::VM::GetVMType (
    const char * vm ) [static]
```

#### 10.368.4.7 GetVMTypeFromLength()

```
static VMType gdcm::VM::GetVMTypeFromLength (
    size_t length,
    unsigned int size ) [static]
```

#### 10.368.4.8 IsValid()

```
static bool gdcm::VM::IsValid (
    int vm1,
    VMType vm2 ) [static]
```

Check if vm1 is valid compare to vm2, i.e vm1 is element of vm2 vm1 is typically deduce from counting in a ValueField

#### 10.368.4.9 operator VMType()

```
gdcm::VM::operator VMType ( ) const [inline]
```

### 10.368.5 Friends And Related Function Documentation

#### 10.368.5.1 operator<<

```
std::ostream& operator<< (
    std::ostream & os,
    const VM & vm ) [friend]
```

The documentation for this class was generated from the following file:

- [gdcmVM.h](#)

## 10.369 `gdcm::VMToLength< T >` Struct Template Reference

The documentation for this struct was generated from the following file:

- [gdcmVM.h](#)

## 10.370 `gdcm::VR` Class Reference

`VR` class.

```
#include <gdcmVR.h>
```

### Public Types

- enum `VRType` : long long {  
    `INVALID` = 0 ,  
    `AE` = 1 ,  
    `AS` = 2 ,  
    `AT` = 4 ,  
    `CS` = 8 ,  
    `DA` = 16 ,  
    `DS` = 32 ,  
    `DT` = 64 ,  
    `FD` = 128 ,  
    `FL` = 256 ,  
    `IS` = 512 ,  
    `LO` = 1024 ,  
    `LT` = 2048 ,  
    `OB` = 4096 ,  
    `OD` = 134217728 ,  
    `OF` = 8192 ,  
    `OL` = 268435456 ,  
    `OV` = 2147483648 ,  
    `OW` = 16384 ,  
    `PN` = 32768 ,  
    `SH` = 65536 ,  
    `SL` = 131072 ,  
    `SQ` = 262144 ,  
    `SS` = 524288 ,  
    `ST` = 1048576 ,  
    `SV` = 4294967296 ,  
    `TM` = 2097152 ,  
    `UC` = 536870912 ,  
    `UI` = 4194304 ,  
    `UL` = 8388608 ,  
    `UN` = 16777216 ,  
    `UR` = 1073741824 ,  
    `US` = 33554432 ,  
    `UT` = 67108864 ,

```

UV = 8589934592 ,
OB_OW = OB | OW ,
US_SS = US | SS ,
US_SS_OW = US | SS | OW ,
US_OW = US | OW ,
VL16 = AE | AS | AT | CS | DA | DS | DT | FD | FL | IS | LO | LT | PN | SH | SL | SS | ST | TM | UI | UL | US ,
VL32 = OB | OW | OD | OF | OL | OV | SQ | SV | UC | UN | UR | UT | UV ,
VRASCII = AE | AS | CS | DA | DS | DT | IS | LO | LT | PN | SH | ST | TM | UC | UI | UR | UT ,
VRBINARY = AT | FL | FD | OB | OD | OF | OL | OV | OW | SL | SQ | SS | SV | UL | UN | US | UV ,
VR_VM1 = AS | LT | ST | UT | SQ | OF | OL | OV | OD | OW | OB | UN ,
VRALL = VRASCII | VRBINARY ,
VR_END = UV+1 }

```

## Public Member Functions

- [VR](#) ([VRType](#) vr=[INVALID](#))
- bool [Compatible](#) ([VR](#) const &vr) const
- int [GetLength](#) () const
- unsigned int [GetSize](#) () const
- unsigned int [GetSizeof](#) () const
- bool [IsDual](#) () const
- bool [IsVRFile](#) () const
- [operator VRType](#) () const
- std::istream & [Read](#) (std::istream &is)
- const std::ostream & [Write](#) (std::ostream &os) const

## Static Public Member Functions

- static bool [CanDisplay](#) ([VRType](#) vr)
- static uint32\_t [GetLength](#) ([VRType](#) vr)
- static const char \* [GetVRString](#) ([VRType](#) vr)
- static const char \* [GetVRStringFromFile](#) ([VRType](#) vr)
- static [VRType](#) [GetVRType](#) (const char \*vr)
- static [VRType](#) [GetVRTypeFromFile](#) (const char \*vr)
- static bool [IsASCII](#) ([VRType](#) vr)
- static bool [IsASCII2](#) ([VRType](#) vr)
- static bool [IsBinary](#) ([VRType](#) vr)
- static bool [IsBinary2](#) ([VRType](#) vr)
- static bool [IsSwap](#) (const char \*vr)
- static bool [IsValid](#) (const char \*vr)
- static bool [IsValid](#) (const char \*vr1, [VRType](#) vr2)

## Friends

- std::ostream & [operator<<](#) (std::ostream &os, const [VR](#) &vr)

### 10.370.1 Detailed Description

VR class.

This is adapted from DICOM standard The biggest difference is the INVALID VR and the composite one that differ from standard (more like an addition) This allow us to represent all the possible case express in the DICOMV3 dict

#### Note

VALUE REPRESENTATION (VR) Specifies the data type and format of the Value(s) contained in the Value Field of a Data Element. VALUE REPRESENTATION FIELD: The field where the Value Representation of a Data Element is stored in the encoding of a Data Element structure with explicit VR.

#### Examples

[GenAllVR.cxx](#), and [GenFakelIdentifyFile.cxx](#).

### 10.370.2 Member Enumeration Documentation

#### 10.370.2.1 VRType

```
enum gdcm::VR::VRType : long long
```

#### Enumerator

INVALID	
AE	
AS	
AT	
CS	
DA	
DS	
DT	
FD	
FL	
IS	
LO	
LT	
OB	
OD	
OF	
OL	
OV	
OW	
PN	
SH	

## Enumerator

SL	
SQ	
SS	
ST	
SV	
TM	
UC	
UI	
UL	
UN	
UR	
US	
UT	
UV	
OB_OW	
US_SS	
US_SS_OW	
US_OW	
VL16	
VL32	
VRASCII	
VRBINARY	
VR_VM1	
VRALL	
VR_END	

## Examples

[NewSequence.cs](#).

### 10.370.3 Constructor & Destructor Documentation

#### 10.370.3.1 VR()

```
gdcm::VR::VR (
    VRType vr = INVALID ) [inline]
```

#### 10.370.4 Member Function Documentation

#### 10.370.4.1 CanDisplay()

```
static bool gdcm::VR::CanDisplay (
    VRType vr ) [static]
```

#### 10.370.4.2 Compatible()

```
bool gdcm::VR::Compatible (
    VR const & vr ) const
```

#### 10.370.4.3 GetLength() [1/2]

```
int gdcm::VR::GetLength ( ) const [inline]
```

#### 10.370.4.4 GetLength() [2/2]

```
static uint32_t gdcm::VR::GetLength (
    VRType vr ) [inline], [static]
```

#### 10.370.4.5 GetSize()

```
unsigned int gdcm::VR::GetSize ( ) const [inline]
```

References AE, AS, AT, CS, DA, DS, DT, FD, FL, INVALID, IS, LT, OB, OB\_OW, OD, OF, OL, OV, OW, PN, SH, SL, SQ, SS, ST, SV, TM, UC, UL, UN, UR, US, US\_OW, US\_SS, US\_SS\_OW, UT, UV, VL16, VL32, VR\_END, VR\_VM1, VRALL, VRASCII, VRBINARY, and VRTypeTemplateCase.

#### 10.370.4.6 GetSizeof()

```
unsigned int gdcm::VR::GetSizeof ( ) const
```

#### 10.370.4.7 GetVRString()

```
static const char* gdcm::VR::GetVRString (
    VRType vr ) [static]
```

#### 10.370.4.8 GetVRStringFromFile()

```
static const char* gdcm::VR::GetVRStringFromFile (
    VRType vr ) [static]
```

#### 10.370.4.9 GetVRType()

```
static VRType gdcm::VR::GetVRType (
    const char * vr ) [static]
```

#### 10.370.4.10 GetVRTypeFromFile()

```
static VRType gdcm::VR::GetVRTypeFromFile (
    const char * vr ) [static]
```

#### 10.370.4.11 IsASCII()

```
static bool gdcm::VR::IsASCII (
    VRType vr ) [static]
```

#### 10.370.4.12 IsASCII2()

```
static bool gdcm::VR::IsASCII2 (
    VRType vr ) [static]
```

**10.370.4.13 IsBinary()**

```
static bool gdcm::VR::IsBinary (
    VRType vr ) [static]
```

**10.370.4.14 IsBinary2()**

```
static bool gdcm::VR::IsBinary2 (
    VRType vr ) [static]
```

**10.370.4.15 IsDual()**

```
bool gdcm::VR::IsDual ( ) const
```

**10.370.4.16 IsSwap()**

```
static bool gdcm::VR::IsSwap (
    const char * vr ) [static]
```

**10.370.4.17 IsValid() [1/2]**

```
static bool gdcm::VR::IsValid (
    const char * vr ) [static]
```

**10.370.4.18 IsValid() [2/2]**

```
static bool gdcm::VR::IsValid (
    const char * vr1,
    VRType vr2 ) [static]
```



#### 10.370.4.19 IsVRFile()

```
bool gdcm::VR::IsVRFile ( ) const
```

Referenced by `gdcm::DataElement::SetVR()`.

#### 10.370.4.20 operator VRType()

```
gdcm::VR::operator VRType ( ) const [inline]
```

#### 10.370.4.21 Read()

```
std::istream& gdcm::VR::Read (
    std::istream & is ) [inline]
```

References `gdcmDebugMacro`, `INVALID`, and `VR_END`.

#### 10.370.4.22 Write()

```
const std::ostream& gdcm::VR::Write (
    std::ostream & os ) const [inline]
```

References `gdcmAssertAlwaysMacro`, and `INVALID`.

### 10.370.5 Friends And Related Function Documentation

#### 10.370.5.1 operator<<

```
std::ostream& operator<< (
    std::ostream & os,
    const VR & vr ) [friend]
```

The documentation for this class was generated from the following file:

- [gdcmVR.h](#)

## 10.371 gdcm::VR16ExplicitDataElement Class Reference

Class to read/write a [DataElement](#) as Explicit Data [Element](#).

```
#include <gdcmVR16ExplicitDataElement.h>
```

Inheritance diagram for gdcm::VR16ExplicitDataElement:

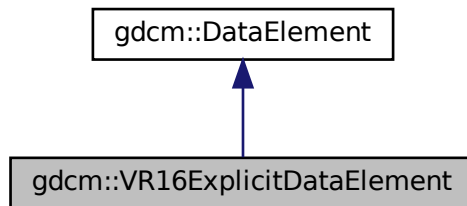

Collaboration diagram for gdcm::VR16ExplicitDataElement:

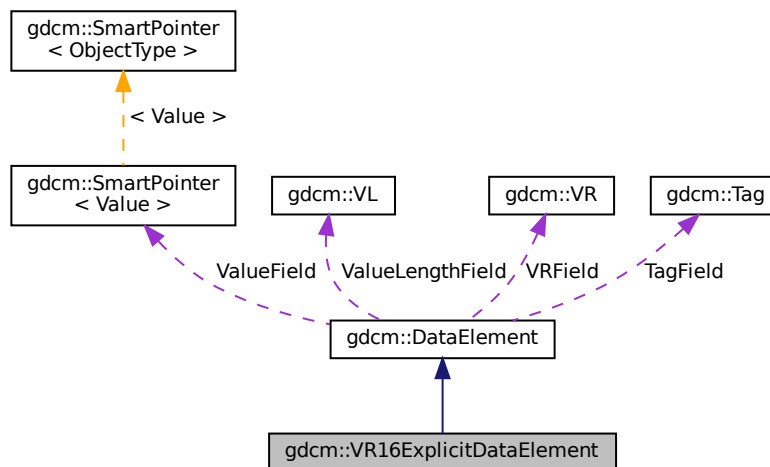

### Public Member Functions

- [VL GetLength](#) () const
- `template<typename TSwap >`  
`std::istream & Read (std::istream &is)`

- `template<typename TSwap >`  
`std::istream & ReadPreValue (std::istream &is)`
- `template<typename TSwap >`  
`std::istream & ReadValue (std::istream &is, bool readvalues=true)`
- `template<typename TSwap >`  
`std::istream & ReadWithLength (std::istream &is, VL &length)`

## Additional Inherited Members

### 10.371.1 Detailed Description

Class to read/write a [DataElement](#) as Explicit Data [Element](#).

#### Note

This class support 16 bits when finding an unknown [VR](#): For instance: Siemens\_CT\_Sensation64\_has\_VR\_RT.↔  
dcm

### 10.371.2 Member Function Documentation

#### 10.371.2.1 GetLength()

```
VL gdcm::VR16ExplicitDataElement::GetLength ( ) const
```

#### 10.371.2.2 Read()

```
template<typename TSwap >  
std::istream& gdcm::VR16ExplicitDataElement::Read (  
    std::istream & is )
```

#### 10.371.2.3 ReadPreValue()

```
template<typename TSwap >  
std::istream& gdcm::VR16ExplicitDataElement::ReadPreValue (  
    std::istream & is )
```

### 10.371.2.4 ReadValue()

```
template<typename TSwap >
std::istream& gdcM::VR16ExplicitDataElement::ReadValue (
    std::istream & is,
    bool readvalues = true )
```

### 10.371.2.5 ReadWithLength()

```
template<typename TSwap >
std::istream& gdcM::VR16ExplicitDataElement::ReadWithLength (
    std::istream & is,
    VL & length )
```

The documentation for this class was generated from the following file:

- [gdcMVR16ExplicitDataElement.h](#)

## 10.372 gdcM::VRToEncoding< T > Struct Template Reference

The documentation for this struct was generated from the following file:

- [gdcMVR.h](#)

## 10.373 gdcM::VRToType< T > Struct Template Reference

Inheritance diagram for gdcM::VRToType< T >:

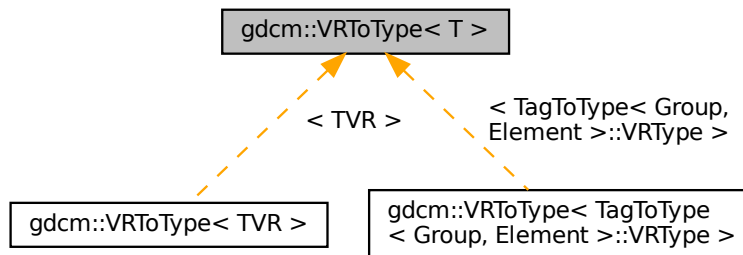

The documentation for this struct was generated from the following file:

- [gdcMVR.h](#)

## 10.374 gdcm::VRVLSize< T > Class Template Reference

The documentation for this class was generated from the following file:

- [gdcmAttribute.h](#)

## 10.375 gdcm::VRVLSize< 0 > Class Reference

```
#include <gdcmAttribute.h>
```

### Static Public Member Functions

- static uint16\_t [Read](#) (std::istream &\_is)
- static void [Write](#) (std::ostream &os)

### 10.375.1 Member Function Documentation

#### 10.375.1.1 Read()

```
static uint16_t gdcm::VRVLSize< 0 >::Read (  
    std::istream & _is ) [inline], [static]
```

#### 10.375.1.2 Write()

```
static void gdcm::VRVLSize< 0 >::Write (  
    std::ostream & os ) [inline], [static]
```

The documentation for this class was generated from the following file:

- [gdcmAttribute.h](#)

## 10.376 gdcm::VRVLSize< 1 > Class Reference

```
#include <gdcmAttribute.h>
```

## Static Public Member Functions

- static uint32\_t [Read](#) (std::istream &\_is)
- static void [Write](#) (std::ostream &os)

### 10.376.1 Member Function Documentation

#### 10.376.1.1 Read()

```
static uint32_t gdcm::VRVLSize< 1 >::Read (  
    std::istream & _is ) [inline], [static]
```

#### 10.376.1.2 Write()

```
static void gdcm::VRVLSize< 1 >::Write (  
    std::ostream & os ) [inline], [static]
```

The documentation for this class was generated from the following file:

- [gdcmAttribute.h](#)

### 10.377 vtkGDCMImageReader Class Reference

```
#include <vtkGDCMImageReader.h>
```

Inheritance diagram for vtkGDCMImageReader:

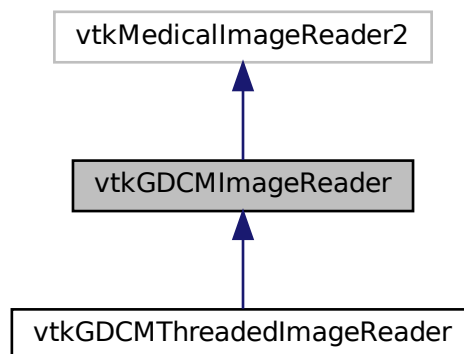

Collaboration diagram for vtkGDCMImageReader:

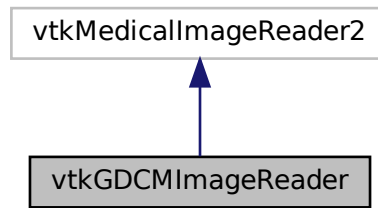

## Public Member Functions

- virtual int [CanReadFile](#) (const char \*fname)
- virtual const char \* [GetDescriptiveName](#) ()
- virtual const char \* [GetFileExtensions](#) ()
- vtkImageData \* [GetIconImage](#) ()
- vtkImageData \* [GetOverlay](#) (int i)
- virtual void [PrintSelf](#) (ostream &os, vtkIndent indent)
- virtual void [SetCurve](#) (vtkPolyData \*pd)
- virtual void [SetFileNames](#) (vtkStringArray \*)
- virtual void [SetMedicalImageProperties](#) (vtkMedicalImageProperties \*pd)
- [vtkBooleanMacro](#) ([ApplyLookupTable](#), int)
- int [vtkBooleanMacro](#) ([ApplyYBRToRGB](#), int)
- [vtkBooleanMacro](#) ([LoadIconImage](#), int)
- [vtkBooleanMacro](#) ([LoadOverlays](#), int)
- [vtkBooleanMacro](#) ([LossyFlag](#), int)
- [vtkGetMacro](#) ([ApplyLookupTable](#), int)
- [vtkGetMacro](#) ([ApplyYBRToRGB](#), int) [vtkSetMacro](#)([ApplyYBRToRGB](#)
- [vtkGetMacro](#) ([ImageFormat](#), int)
- [vtkGetMacro](#) ([LoadIconImage](#), int)
- [vtkGetMacro](#) ([LoadOverlays](#), int)
- [vtkGetMacro](#) ([LossyFlag](#), int)
- [vtkGetMacro](#) ([NumberOfIconImages](#), int)
- [vtkGetMacro](#) ([NumberOfOverlays](#), int)
- [vtkGetMacro](#) ([PlanarConfiguration](#), int)
- [vtkGetMacro](#) ([Scale](#), double)
- [vtkGetMacro](#) ([Shift](#), double)
- [vtkGetObjectMacro](#) ([Curve](#), vtkPolyData)
- [vtkGetObjectMacro](#) ([DirectionCosines](#), vtkMatrix4x4)
- [vtkGetObjectMacro](#) ([FileNames](#), vtkStringArray)
- [vtkGetObjectMacro](#) ([MedicalImageProperties](#), vtkMedicalImageProperties)
- [vtkGetVector3Macro](#) ([ImagePositionPatient](#), double)
- [vtkGetVector6Macro](#) ([ImageOrientationPatient](#), double)
- [vtkSetMacro](#) ([ApplyLookupTable](#), int)

- [vtkSetMacro](#) ([LoadIconImage](#), int)
- [vtkSetMacro](#) ([LoadOverlays](#), int)
- [vtkSetMacro](#) ([LossyFlag](#), int)
- [vtkTypeMacro](#) ([vtkGDCMImageReader](#), [vtkMedicalImageReader2](#))

## Static Public Member Functions

- static [vtkGDCMImageReader](#) \* [New](#) ()

## Protected Member Functions

- [vtkGDCMImageReader](#) ()
- [~vtkGDCMImageReader](#) ()
- void [ExecuteData](#) ([vtkDataObject](#) \*out)
- void [ExecuteInformation](#) ()
- void [FillMedicalImageInformation](#) (const [gdcm::ImageReader](#) &reader)
- int [LoadSingleFile](#) (const char \*filename, char \*pointer, unsigned long &outlen)
- int [RequestDataCompat](#) ()
- int [RequestInformationCompat](#) ()
- void [SetFilePattern](#) (const char \*)
- void [SetFilePrefix](#) (const char \*)
- [vtkGetStringMacro](#) ([FilePattern](#))
- [vtkGetStringMacro](#) ([FilePrefix](#))
- [vtkSetVector6Macro](#) ([ImageOrientationPatient](#), double)

## Protected Attributes

- int [ApplyInverseVideo](#)
- int [ApplyLookupTable](#)
- int [ApplyPlanarConfiguration](#)
- int [ApplyShiftScale](#)
- int [ApplyYBRToRGB](#)
- [vtkPolyData](#) \* [Curve](#)
- [vtkMatrix4x4](#) \* [DirectionCosines](#)
- [vtkStringArray](#) \* [FileNames](#)
- int [ForceRescale](#)
- int [IconDataScalarType](#)
- int [IconImageDataExtent](#) [6]
- int [IconNumberOfScalarComponents](#)
- int [ImageFormat](#)
- double [ImageOrientationPatient](#) [6]
- double [ImagePositionPatient](#) [3]
- int [LoadIconImage](#)
- int [LoadOverlays](#)
- int [LossyFlag](#)
- [vtkMedicalImageProperties](#) \* [MedicalImageProperties](#)
- int [NumberOfIconImages](#)
- int [NumberOfOverlays](#)
- int [PlanarConfiguration](#)
- double [Scale](#)
- double [Shift](#)



## 10.377.1 Detailed Description

### Examples

[AWTMedical3.java](#), [Convert16BitsTo8Bits.cxx](#), [ConvertMultiFrameToSingleFrame.cxx](#), [ConvertRGBToLuminance.cxx](#), [ConvertSingleBitTo8Bits.cxx](#), [HelloActiviz.cs](#), [HelloActiviz2.cs](#), [HelloActiviz3.cs](#), [HelloActiviz4.cs](#), [HelloActiviz5.cs](#), [HelloVTKWorld.cs](#), [HelloVTKWorld.java](#), [MIPViewer.java](#), [MPRViewer.java](#), [MPRViewer2.java](#), [MagnifyFile.cxx](#), [MetalImageMD5Activiz.cs](#), [ReadSeriesIntoVTK.java](#), [RefCounting.cs](#), [gdcmothoplanes.cxx](#), [gdcmreslice.cxx](#), [gdcmttexture.cxx](#), [gdcmvolume.cxx](#), [offscreenimage.cxx](#), and [reslicesphere.cxx](#).

## 10.377.2 Constructor & Destructor Documentation

### 10.377.2.1 vtkGDCMImageReader()

```
vtkGDCMImageReader::vtkGDCMImageReader ( ) [protected]
```

### Examples

[HelloActiviz2.cs](#).

### 10.377.2.2 ~vtkGDCMImageReader()

```
vtkGDCMImageReader::~~vtkGDCMImageReader ( ) [protected]
```

## 10.377.3 Member Function Documentation

### 10.377.3.1 CanReadFile()

```
virtual int vtkGDCMImageReader::CanReadFile (
    const char * fname ) [virtual]
```

### Examples

[AWTMedical3.java](#), and [MetalImageMD5Activiz.cs](#).

### 10.377.3.2 ExecuteData()

```
void vtkGDCMImageReader::ExecuteData (
    vtkDataObject * out ) [protected]
```

### 10.377.3.3 ExecuteInformation()

```
void vtkGDCMImageReader::ExecuteInformation ( ) [protected]
```

### 10.377.3.4 FillMedicalImageInformation()

```
void vtkGDCMImageReader::FillMedicalImageInformation (
    const gdcm::ImageReader & reader ) [protected]
```

### 10.377.3.5 GetDescriptiveName()

```
virtual const char* vtkGDCMImageReader::GetDescriptiveName ( ) [inline], [virtual]
```

### 10.377.3.6 GetFileExtensions()

```
virtual const char* vtkGDCMImageReader::GetFileExtensions ( ) [inline], [virtual]
```

### 10.377.3.7 GetIconImage()

```
vtkImageData* vtkGDCMImageReader::GetIconImage ( )
```

### 10.377.3.8 GetOverlay()

```
vtkImageData* vtkGDCMImageReader::GetOverlay (
    int i )
```

### 10.377.3.9 LoadSingleFile()

```
int vtkGDCMImageReader::LoadSingleFile (
    const char * filename,
    char * pointer,
    unsigned long & outlen ) [protected]
```

### 10.377.3.10 New()

```
static vtkGDCMImageReader* vtkGDCMImageReader::New ( ) [static]
```

#### Examples

[Convert16BitsTo8Bits.cxx](#), [ConvertMultiFrameToSingleFrame.cxx](#), [ConvertRGBToLuminance.cxx](#), [ConvertSingleBitTo8Bits.cxx](#), [HelloActiviz.cs](#), [HelloActiviz3.cs](#), [HelloActiviz4.cs](#), [HelloActiviz5.cs](#), [HelloVTKWorld.cs](#), [MagnifyFile.cxx](#), [MetalImageMD5Activiz.cs](#), [RefCounting.cs](#), [gdcmothoplanes.cxx](#), [gdcmreslice.cxx](#), [gdcmttexture.cxx](#), [gdcmvolume.cxx](#), [offscreenimage.cxx](#), and [reslicesphere.cxx](#).

### 10.377.3.11 PrintSelf()

```
virtual void vtkGDCMImageReader::PrintSelf (
    ostream & os,
    vtkIndent indent ) [virtual]
```

Reimplemented in [vtkGDCMThreadedImageReader](#).

### 10.377.3.12 RequestDataCompat()

```
int vtkGDCMImageReader::RequestDataCompat ( ) [protected]
```

### 10.377.3.13 RequestInformationCompat()

```
int vtkGDCMImageReader::RequestInformationCompat ( ) [protected]
```

#### 10.377.3.14 SetCurve()

```
virtual void vtkGDCMImageReader::SetCurve (
    vtkPolyData * pd ) [virtual]
```

#### 10.377.3.15 SetFileNames()

```
virtual void vtkGDCMImageReader::SetFileNames (
    vtkStringArray * ) [virtual]
```

#### Examples

[AWTMedical3.java](#), [HelloActiviz3.cs](#), [HelloActiviz4.cs](#), [HelloActiviz5.cs](#), [MIPViewer.java](#), [MPRViewer.java](#), [MPRViewer2.java](#), [ReadSeriesIntoVTK.java](#), and [gdcmmorthoplanes.cxx](#).

#### 10.377.3.16 SetFilePattern()

```
void vtkGDCMImageReader::SetFilePattern (
    const char * ) [inline], [protected]
```

#### 10.377.3.17 SetFilePrefix()

```
void vtkGDCMImageReader::SetFilePrefix (
    const char * ) [inline], [protected]
```

#### 10.377.3.18 SetMedicalImageProperties()

```
virtual void vtkGDCMImageReader::SetMedicalImageProperties (
    vtkMedicalImageProperties * pd ) [virtual]
```

#### 10.377.3.19 vtkBooleanMacro() [1/5]

```
vtkGDCMImageReader::vtkBooleanMacro (
    ApplyLookupTable ,
    int )
```

**10.377.3.20 vtkBooleanMacro()** [2/5]

```
int vtkGDCMImageReader::vtkBooleanMacro (
    ApplyYBRToRGB ,
    int )
```

**10.377.3.21 vtkBooleanMacro()** [3/5]

```
vtkGDCMImageReader::vtkBooleanMacro (
    LoadIconImage ,
    int )
```

**10.377.3.22 vtkBooleanMacro()** [4/5]

```
vtkGDCMImageReader::vtkBooleanMacro (
    LoadOverlays ,
    int )
```

**10.377.3.23 vtkBooleanMacro()** [5/5]

```
vtkGDCMImageReader::vtkBooleanMacro (
    LossyFlag ,
    int )
```

**10.377.3.24 vtkGetMacro()** [1/11]

```
vtkGDCMImageReader::vtkGetMacro (
    ApplyLookupTable ,
    int )
```

**10.377.3.25 vtkGetMacro()** [2/11]

```
vtkGDCMImageReader::vtkGetMacro (
    ApplyYBRToRGB ,
    int )
```

**10.377.3.26 vtkGetMacro()** [3/11]

```
vtkGDCMImageReader::vtkGetMacro (
    ImageFormat ,
    int )
```

**10.377.3.27 vtkGetMacro()** [4/11]

```
vtkGDCMImageReader::vtkGetMacro (
    LoadIconImage ,
    int )
```

**10.377.3.28 vtkGetMacro()** [5/11]

```
vtkGDCMImageReader::vtkGetMacro (
    LoadOverlays ,
    int )
```

**10.377.3.29 vtkGetMacro()** [6/11]

```
vtkGDCMImageReader::vtkGetMacro (
    LossyFlag ,
    int )
```

**10.377.3.30 vtkGetMacro()** [7/11]

```
vtkGDCMImageReader::vtkGetMacro (
    NumberOfIconImages ,
    int )
```

**10.377.3.31 vtkGetMacro()** [8/11]

```
vtkGDCMImageReader::vtkGetMacro (
    NumberOfOverlays ,
    int )
```

**10.377.3.32 vtkGetMacro()** [9/11]

```
vtkGDCMImageReader::vtkGetMacro (
    PlanarConfiguration ,
    int )
```

**10.377.3.33 vtkGetMacro()** [10/11]

```
vtkGDCMImageReader::vtkGetMacro (
    Scale ,
    double )
```

**10.377.3.34 vtkGetMacro()** [11/11]

```
vtkGDCMImageReader::vtkGetMacro (
    Shift ,
    double )
```

**10.377.3.35 vtkGetObjectMacro()** [1/4]

```
vtkGDCMImageReader::vtkGetObjectMacro (
    Curve ,
    vtkPolyData )
```

**10.377.3.36 vtkGetObjectMacro()** [2/4]

```
vtkGDCMImageReader::vtkGetObjectMacro (
    DirectionCosines ,
    vtkMatrix4x4 )
```

**10.377.3.37 vtkGetObjectMacro()** [3/4]

```
vtkGDCMImageReader::vtkGetObjectMacro (
    FileNames ,
    vtkStringArray )
```

**10.377.3.38 vtkGetObjectMacro() [4/4]**

```
vtkGDCMImageReader::vtkGetObjectMacro (
    MedicalImageProperties ,
    vtkMedicalImageProperties )
```

**10.377.3.39 vtkGetStringMacro() [1/2]**

```
vtkGDCMImageReader::vtkGetStringMacro (
    FilePattern ) [protected]
```

**10.377.3.40 vtkGetStringMacro() [2/2]**

```
vtkGDCMImageReader::vtkGetStringMacro (
    FilePrefix ) [protected]
```

**10.377.3.41 vtkGetVector3Macro()**

```
vtkGDCMImageReader::vtkGetVector3Macro (
    ImagePositionPatient ,
    double )
```

**10.377.3.42 vtkGetVector6Macro()**

```
vtkGDCMImageReader::vtkGetVector6Macro (
    ImageOrientationPatient ,
    double )
```

**10.377.3.43 vtkSetMacro() [1/4]**

```
vtkGDCMImageReader::vtkSetMacro (
    ApplyLookupTable ,
    int )
```



**10.377.3.44 vtkSetMacro() [2/4]**

```
vtkGDCMImageReader::vtkSetMacro (
    LoadIconImage ,
    int )
```

**10.377.3.45 vtkSetMacro() [3/4]**

```
vtkGDCMImageReader::vtkSetMacro (
    LoadOverlays ,
    int )
```

**10.377.3.46 vtkSetMacro() [4/4]**

```
vtkGDCMImageReader::vtkSetMacro (
    LossyFlag ,
    int )
```

**10.377.3.47 vtkSetVector6Macro()**

```
vtkGDCMImageReader::vtkSetVector6Macro (
    ImageOrientationPatient ,
    double ) [protected]
```

**10.377.3.48 vtkTypeMacro()**

```
vtkGDCMImageReader::vtkTypeMacro (
    vtkGDCMImageReader ,
    vtkMedicalImageReader2 )
```

**10.377.4 Member Data Documentation**

**10.377.4.1 ApplyInverseVideo**

```
int vtkGDCMImageReader::ApplyInverseVideo [protected]
```

**10.377.4.2 ApplyLookupTable**

```
int vtkGDCMImageReader::ApplyLookupTable [protected]
```

**10.377.4.3 ApplyPlanarConfiguration**

```
int vtkGDCMImageReader::ApplyPlanarConfiguration [protected]
```

**10.377.4.4 ApplyShiftScale**

```
int vtkGDCMImageReader::ApplyShiftScale [protected]
```

**10.377.4.5 ApplyYBRToRGB**

```
int vtkGDCMImageReader::ApplyYBRToRGB [protected]
```

**10.377.4.6 Curve**

```
vtkPolyData* vtkGDCMImageReader::Curve [protected]
```

**10.377.4.7 DirectionCosines**

```
vtkMatrix4x4* vtkGDCMImageReader::DirectionCosines [protected]
```

#### 10.377.4.8 FileNames

vtkStringArray\* vtkGDCMImageReader::FileNames [protected]

#### 10.377.4.9 ForceRescale

int vtkGDCMImageReader::ForceRescale [protected]

#### 10.377.4.10 IconDataScalarType

int vtkGDCMImageReader::IconDataScalarType [protected]

#### 10.377.4.11 IconImageDataExtent

int vtkGDCMImageReader::IconImageDataExtent[6] [protected]

#### 10.377.4.12 IconNumberOfScalarComponents

int vtkGDCMImageReader::IconNumberOfScalarComponents [protected]

#### 10.377.4.13 ImageFormat

int vtkGDCMImageReader::ImageFormat [protected]

#### 10.377.4.14 ImageOrientationPatient

double vtkGDCMImageReader::ImageOrientationPatient[6] [protected]

**10.377.4.15 ImagePositionPatient**

```
double vtkGDCMImageReader::ImagePositionPatient[3] [protected]
```

**10.377.4.16 LoadIconImage**

```
int vtkGDCMImageReader::LoadIconImage [protected]
```

**10.377.4.17 LoadOverlays**

```
int vtkGDCMImageReader::LoadOverlays [protected]
```

**10.377.4.18 LossyFlag**

```
int vtkGDCMImageReader::LossyFlag [protected]
```

**10.377.4.19 MedicalImageProperties**

```
vtkMedicalImageProperties* vtkGDCMImageReader::MedicalImageProperties [protected]
```

**10.377.4.20 NumberOfIconImages**

```
int vtkGDCMImageReader::NumberOfIconImages [protected]
```

**10.377.4.21 NumberOfOverlays**

```
int vtkGDCMImageReader::NumberOfOverlays [protected]
```

### 10.377.4.22 PlanarConfiguration

```
int vtkGDCMImageReader::PlanarConfiguration [protected]
```

### 10.377.4.23 Scale

```
double vtkGDCMImageReader::Scale [protected]
```

### 10.377.4.24 Shift

```
double vtkGDCMImageReader::Shift [protected]
```

The documentation for this class was generated from the following file:

- [vtkGDCMImageReader.h](#)

## 10.378 vtkGDCMImageReader2 Class Reference

```
#include <vtkGDCMImageReader2.h>
```

Inheritance diagram for vtkGDCMImageReader2:

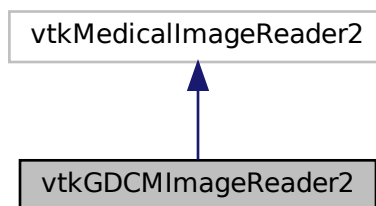

Collaboration diagram for vtkGDCMImageReader2:

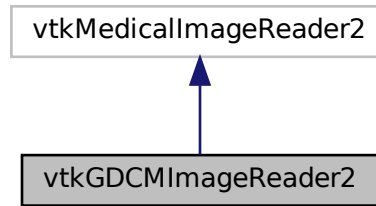

## Public Member Functions

- virtual int [CanReadFile](#) (const char \*fname)
- virtual const char \* [GetDescriptiveName](#) ()
- virtual const char \* [GetFileExtensions](#) ()
- vtkImageData \* [GetIconImage](#) ()
- vtkAlgorithmOutput \* [GetIconImagePort](#) ()
- vtkImageData \* [GetOverlay](#) (int i)
- vtkAlgorithmOutput \* [GetOverlayPort](#) (int index)
- virtual void [PrintSelf](#) (ostream &os, vtkIndent indent)
- virtual void [SetCurve](#) (vtkPolyData \*pd)
- virtual void [SetMedicalImageProperties](#) (vtkMedicalImageProperties \*pd)
- [vtkBooleanMacro](#) ([ApplyLookupTable](#), int)
- int [vtkBooleanMacro](#) ([ApplyYBRToRGB](#), int)
- [vtkBooleanMacro](#) ([LoadIconImage](#), int)
- [vtkBooleanMacro](#) ([LoadOverlays](#), int)
- [vtkBooleanMacro](#) ([LossyFlag](#), int)
- [vtkGetMacro](#) ([ApplyLookupTable](#), int)
- [vtkGetMacro](#) ([ApplyYBRToRGB](#), int) [vtkSetMacro](#)([ApplyYBRToRGB](#)
- [vtkGetMacro](#) ([ImageFormat](#), int)
- [vtkGetMacro](#) ([LoadIconImage](#), int)
- [vtkGetMacro](#) ([LoadOverlays](#), int)
- [vtkGetMacro](#) ([LossyFlag](#), int)
- [vtkGetMacro](#) ([NumberOfIconImages](#), int)
- [vtkGetMacro](#) ([NumberOfOverlays](#), int)
- [vtkGetMacro](#) ([PlanarConfiguration](#), int)
- [vtkGetMacro](#) ([Scale](#), double)
- [vtkGetMacro](#) ([Shift](#), double)
- [vtkGetObjectMacro](#) ([Curve](#), vtkPolyData)
- [vtkGetObjectMacro](#) ([DirectionCosines](#), vtkMatrix4x4)
- [vtkGetVector3Macro](#) ([ImagePositionPatient](#), double)
- [vtkGetVector6Macro](#) ([ImageOrientationPatient](#), double)
- [vtkSetMacro](#) ([ApplyLookupTable](#), int)
- [vtkSetMacro](#) ([LoadIconImage](#), int)
- [vtkSetMacro](#) ([LoadOverlays](#), int)
- [vtkSetMacro](#) ([LossyFlag](#), int)
- [vtkTypeMacro](#) ([vtkGDCMImageReader2](#), vtkMedicalImageReader2)

## Static Public Member Functions

- static [vtkGDCMImageReader2 \\* New \(\)](#)

## Protected Member Functions

- [vtkGDCMImageReader2 \(\)](#)
- [~vtkGDCMImageReader2 \(\)](#)
- void [FillMedicalImageInformation](#) (const [gdcm::ImageReader](#) &reader)
- int [LoadSingleFile](#) (const char \*filename, char \*pointer, unsigned long &outlen)
- int [ProcessRequest](#) (vtkInformation \*request, vtkInformationVector \*\*inputVector, vtkInformationVector \*outputVector)
- int [RequestData](#) (vtkInformation \*request, vtkInformationVector \*\*inputVector, vtkInformationVector \*outputVector)
- int [RequestDataCompat \(\)](#)
- int [RequestInformation](#) (vtkInformation \*request, vtkInformationVector \*\*inputVector, vtkInformationVector \*outputVector)
- int [RequestInformationCompat \(\)](#)
- void [SetFilePattern](#) (const char \*)
- void [SetFilePrefix](#) (const char \*)
- [vtkGetStringMacro](#) (FilePattern)
- [vtkGetStringMacro](#) (FilePrefix)
- [vtkSetVector6Macro](#) (ImageOrientationPatient, double)

## Protected Attributes

- int [ApplyInverseVideo](#)
- int [ApplyLookupTable](#)
- int [ApplyPlanarConfiguration](#)
- int [ApplyShiftScale](#)
- int [ApplyYBRToRGB](#)
- vtkPolyData \* [Curve](#)
- vtkMatrix4x4 \* [DirectionCosines](#)
- int [ForceRescale](#)
- int [IconDataScalarType](#)
- int [IconImageDataExtent](#) [6]
- int [IconNumberOfScalarComponents](#)
- int [ImageFormat](#)
- double [ImageOrientationPatient](#) [6]
- double [ImagePositionPatient](#) [3]
- int [LoadIconImage](#)
- int [LoadOverlays](#)
- int [LossyFlag](#)
- int [NumberOfIconImages](#)
- int [NumberOfOverlays](#)
- int [PlanarConfiguration](#)
- double [Scale](#)
- double [Shift](#)

## 10.378.1 Detailed Description

### Examples

[Compute3DSpacing.cxx](#).

## 10.378.2 Constructor & Destructor Documentation

### 10.378.2.1 vtkGDCMImageReader2()

```
vtkGDCMImageReader2::vtkGDCMImageReader2 ( ) [protected]
```

### 10.378.2.2 ~vtkGDCMImageReader2()

```
vtkGDCMImageReader2::~~vtkGDCMImageReader2 ( ) [protected]
```

## 10.378.3 Member Function Documentation

### 10.378.3.1 CanReadFile()

```
virtual int vtkGDCMImageReader2::CanReadFile (
    const char * fname ) [virtual]
```

### 10.378.3.2 FillMedicalImageInformation()

```
void vtkGDCMImageReader2::FillMedicalImageInformation (
    const gdcm::ImageReader & reader ) [protected]
```

### 10.378.3.3 GetDescriptiveName()

```
virtual const char* vtkGDCMImageReader2::GetDescriptiveName ( ) [inline], [virtual]
```



### 10.378.3.4 GetFileExtensions()

```
virtual const char* vtkGDCMImageReader2::GetFileExtensions ( ) [inline], [virtual]
```

### 10.378.3.5 GetIconImage()

```
vtkImageData* vtkGDCMImageReader2::GetIconImage ( )
```

### 10.378.3.6 GetIconImagePort()

```
vtkAlgorithmOutput* vtkGDCMImageReader2::GetIconImagePort ( )
```

### 10.378.3.7 GetOverlay()

```
vtkImageData* vtkGDCMImageReader2::GetOverlay (
    int i )
```

### 10.378.3.8 GetOverlayPort()

```
vtkAlgorithmOutput* vtkGDCMImageReader2::GetOverlayPort (
    int index )
```

### 10.378.3.9 LoadSingleFile()

```
int vtkGDCMImageReader2::LoadSingleFile (
    const char * filename,
    char * pointer,
    unsigned long & outlen ) [protected]
```

### 10.378.3.10 New()

```
static vtkGDCMImageReader2* vtkGDCMImageReader2::New ( ) [static]
```

#### Examples

[Compute3DSpacing.cxx](#).

### 10.378.3.11 PrintSelf()

```
virtual void vtkGDCMImageReader2::PrintSelf (
    ostream & os,
    vtkIndent indent ) [virtual]
```

### 10.378.3.12 ProcessRequest()

```
int vtkGDCMImageReader2::ProcessRequest (
    vtkInformation * request,
    vtkInformationVector ** inputVector,
    vtkInformationVector * outputVector ) [protected]
```

### 10.378.3.13 RequestData()

```
int vtkGDCMImageReader2::RequestData (
    vtkInformation * request,
    vtkInformationVector ** inputVector,
    vtkInformationVector * outputVector ) [protected]
```

### 10.378.3.14 RequestDataCompat()

```
int vtkGDCMImageReader2::RequestDataCompat ( ) [protected]
```

### 10.378.3.15 RequestInformation()

```
int vtkGDCMImageReader2::RequestInformation (
    vtkInformation * request,
    vtkInformationVector ** inputVector,
    vtkInformationVector * outputVector ) [protected]
```

### 10.378.3.16 RequestInformationCompat()

```
int vtkGDCMImageReader2::RequestInformationCompat ( ) [protected]
```

### 10.378.3.17 SetCurve()

```
virtual void vtkGDCMImageReader2::SetCurve (
    vtkPolyData * pd ) [virtual]
```

### 10.378.3.18 SetFilePattern()

```
void vtkGDCMImageReader2::SetFilePattern (
    const char * ) [inline], [protected]
```

### 10.378.3.19 SetFilePrefix()

```
void vtkGDCMImageReader2::SetFilePrefix (
    const char * ) [inline], [protected]
```

### 10.378.3.20 SetMedicalImageProperties()

```
virtual void vtkGDCMImageReader2::SetMedicalImageProperties (
    vtkMedicalImageProperties * pd ) [virtual]
```

**10.378.3.21 vtkBooleanMacro()** [1/5]

```
vtkGDCMImageReader2::vtkBooleanMacro (  
    ApplyLookupTable ,  
    int )
```

**10.378.3.22 vtkBooleanMacro()** [2/5]

```
int vtkGDCMImageReader2::vtkBooleanMacro (  
    ApplyYBRToRGB ,  
    int )
```

**10.378.3.23 vtkBooleanMacro()** [3/5]

```
vtkGDCMImageReader2::vtkBooleanMacro (  
    LoadIconImage ,  
    int )
```

**10.378.3.24 vtkBooleanMacro()** [4/5]

```
vtkGDCMImageReader2::vtkBooleanMacro (  
    LoadOverlays ,  
    int )
```

**10.378.3.25 vtkBooleanMacro()** [5/5]

```
vtkGDCMImageReader2::vtkBooleanMacro (  
    LossyFlag ,  
    int )
```

**10.378.3.26 vtkGetMacro()** [1/11]

```
vtkGDCMImageReader2::vtkGetMacro (  
    ApplyLookupTable ,  
    int )
```

**10.378.3.27 vtkGetMacro()** [2/11]

```
vtkGDCMImageReader2::vtkGetMacro (
    ApplyYBRToRGB ,
    int )
```

**10.378.3.28 vtkGetMacro()** [3/11]

```
vtkGDCMImageReader2::vtkGetMacro (
    ImageFormat ,
    int )
```

**10.378.3.29 vtkGetMacro()** [4/11]

```
vtkGDCMImageReader2::vtkGetMacro (
    LoadIconImage ,
    int )
```

**10.378.3.30 vtkGetMacro()** [5/11]

```
vtkGDCMImageReader2::vtkGetMacro (
    LoadOverlays ,
    int )
```

**10.378.3.31 vtkGetMacro()** [6/11]

```
vtkGDCMImageReader2::vtkGetMacro (
    LossyFlag ,
    int )
```

**10.378.3.32 vtkGetMacro()** [7/11]

```
vtkGDCMImageReader2::vtkGetMacro (
    NumberOfIconImages ,
    int )
```

**10.378.3.33 vtkGetMacro()** [8/11]

```
vtkGDCMImageReader2::vtkGetMacro (
    NumberOfOverlays ,
    int )
```

**10.378.3.34 vtkGetMacro()** [9/11]

```
vtkGDCMImageReader2::vtkGetMacro (
    PlanarConfiguration ,
    int )
```

**10.378.3.35 vtkGetMacro()** [10/11]

```
vtkGDCMImageReader2::vtkGetMacro (
    Scale ,
    double )
```

**10.378.3.36 vtkGetMacro()** [11/11]

```
vtkGDCMImageReader2::vtkGetMacro (
    Shift ,
    double )
```

**10.378.3.37 vtkGetObjectMacro()** [1/2]

```
vtkGDCMImageReader2::vtkGetObjectMacro (
    Curve ,
    vtkPolyData )
```

**10.378.3.38 vtkGetObjectMacro()** [2/2]

```
vtkGDCMImageReader2::vtkGetObjectMacro (
    DirectionCosines ,
    vtkMatrix4x4 )
```

**10.378.3.39 vtkGetStringMacro()** [1/2]

```
vtkGDCMImageReader2::vtkGetStringMacro (
    FilePattern ) [protected]
```

**10.378.3.40 vtkGetStringMacro()** [2/2]

```
vtkGDCMImageReader2::vtkGetStringMacro (
    FilePrefix ) [protected]
```

**10.378.3.41 vtkGetVector3Macro()**

```
vtkGDCMImageReader2::vtkGetVector3Macro (
    ImagePositionPatient ,
    double )
```

**10.378.3.42 vtkGetVector6Macro()**

```
vtkGDCMImageReader2::vtkGetVector6Macro (
    ImageOrientationPatient ,
    double )
```

**10.378.3.43 vtkSetMacro()** [1/4]

```
vtkGDCMImageReader2::vtkSetMacro (
    ApplyLookupTable ,
    int )
```

**10.378.3.44 vtkSetMacro()** [2/4]

```
vtkGDCMImageReader2::vtkSetMacro (
    LoadIconImage ,
    int )
```

### 10.378.3.45 vtkSetMacro() [3/4]

```
vtkGDCMImageReader2::vtkSetMacro (
    LoadOverlays ,
    int )
```

### 10.378.3.46 vtkSetMacro() [4/4]

```
vtkGDCMImageReader2::vtkSetMacro (
    LossyFlag ,
    int )
```

### 10.378.3.47 vtkSetVector6Macro()

```
vtkGDCMImageReader2::vtkSetVector6Macro (
    ImageOrientationPatient ,
    double ) [protected]
```

### 10.378.3.48 vtkTypeMacro()

```
vtkGDCMImageReader2::vtkTypeMacro (
    vtkGDCMImageReader2 ,
    vtkMedicalImageReader2 )
```

## 10.378.4 Member Data Documentation

### 10.378.4.1 ApplyInverseVideo

```
int vtkGDCMImageReader2::ApplyInverseVideo [protected]
```

### 10.378.4.2 ApplyLookupTable

```
int vtkGDCMImageReader2::ApplyLookupTable [protected]
```



### 10.378.4.3 ApplyPlanarConfiguration

```
int vtkGDCMImageReader2::ApplyPlanarConfiguration [protected]
```

### 10.378.4.4 ApplyShiftScale

```
int vtkGDCMImageReader2::ApplyShiftScale [protected]
```

### 10.378.4.5 ApplyYBRToRGB

```
int vtkGDCMImageReader2::ApplyYBRToRGB [protected]
```

### 10.378.4.6 Curve

```
vtkPolyData* vtkGDCMImageReader2::Curve [protected]
```

### 10.378.4.7 DirectionCosines

```
vtkMatrix4x4* vtkGDCMImageReader2::DirectionCosines [protected]
```

### 10.378.4.8 ForceRescale

```
int vtkGDCMImageReader2::ForceRescale [protected]
```

### 10.378.4.9 IconDataScalarType

```
int vtkGDCMImageReader2::IconDataScalarType [protected]
```

**10.378.4.10 IconImageDataExtent**

```
int vtkGDCMImageReader2::IconImageDataExtent[6] [protected]
```

**10.378.4.11 IconNumberOfScalarComponents**

```
int vtkGDCMImageReader2::IconNumberOfScalarComponents [protected]
```

**10.378.4.12 ImageFormat**

```
int vtkGDCMImageReader2::ImageFormat [protected]
```

**10.378.4.13 ImageOrientationPatient**

```
double vtkGDCMImageReader2::ImageOrientationPatient[6] [protected]
```

**10.378.4.14 ImagePositionPatient**

```
double vtkGDCMImageReader2::ImagePositionPatient[3] [protected]
```

**10.378.4.15 LoadIconImage**

```
int vtkGDCMImageReader2::LoadIconImage [protected]
```

**10.378.4.16 LoadOverlays**

```
int vtkGDCMImageReader2::LoadOverlays [protected]
```

#### 10.378.4.17 LossyFlag

```
int vtkGDCMImageReader2::LossyFlag [protected]
```

#### 10.378.4.18 NumberOfIconImages

```
int vtkGDCMImageReader2::NumberOfIconImages [protected]
```

#### 10.378.4.19 NumberOfOverlays

```
int vtkGDCMImageReader2::NumberOfOverlays [protected]
```

#### 10.378.4.20 PlanarConfiguration

```
int vtkGDCMImageReader2::PlanarConfiguration [protected]
```

#### 10.378.4.21 Scale

```
double vtkGDCMImageReader2::Scale [protected]
```

#### 10.378.4.22 Shift

```
double vtkGDCMImageReader2::Shift [protected]
```

The documentation for this class was generated from the following file:

- [vtkGDCMImageReader2.h](#)

## 10.379 vtkGDCMImageWriter Class Reference

```
#include <vtkGDCMImageWriter.h>
```

Inheritance diagram for vtkGDCMImageWriter:

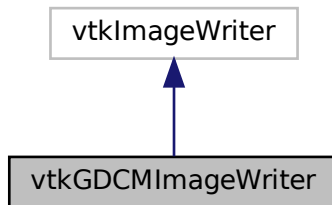

Collaboration diagram for vtkGDCMImageWriter:

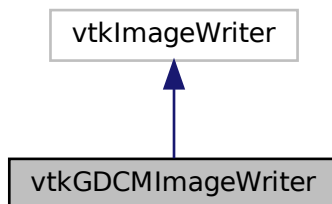

### Public Types

- enum `CompressionTypes` {  
    `NO_COMPRESSION` = 0 ,  
    `JPEG_COMPRESSION` ,  
    `JPEG2000_COMPRESSION` ,  
    `JPEGLS_COMPRESSION` ,  
    `RLE_COMPRESSION` }

## Public Member Functions

- virtual const char \* [GetDescriptiveName](#) ()
- virtual const char \* [GetFileExtensions](#) ()
- virtual void [PrintSelf](#) (ostream &os, vtkIndent indent)
- virtual void [SetDirectionCosines](#) (vtkMatrix4x4 \*matrix)
- virtual void [SetDirectionCosinesFromImageOrientationPatient](#) (const double dircos[6])
- virtual void [SetFileNames](#) (vtkStringArray \*)
- virtual void [SetMedicalImageProperties](#) (vtkMedicalImageProperties \*)
- [vtkBooleanMacro](#) (FileLowerLeft, int)
- [vtkBooleanMacro](#) (LossyFlag, int)
- [vtkGetMacro](#) (CompressionType, int)
- [vtkGetMacro](#) (FileLowerLeft, int)
- [vtkGetMacro](#) (ImageFormat, int)
- [vtkGetMacro](#) (LossyFlag, int)
- [vtkGetMacro](#) (PlanarConfiguration, int)
- [vtkGetMacro](#) (Scale, double)
- [vtkGetMacro](#) (Shift, double)
- [vtkGetObjectMacro](#) (DirectionCosines, vtkMatrix4x4)
- [vtkGetObjectMacro](#) (FileNames, vtkStringArray)
- [vtkGetObjectMacro](#) (MedicalImageProperties, vtkMedicalImageProperties)
- [vtkGetStringMacro](#) (SeriesUID)
- [vtkGetStringMacro](#) (StudyUID)
- [vtkSetMacro](#) (CompressionType, int)
- [vtkSetMacro](#) (FileLowerLeft, int)
- [vtkSetMacro](#) (ImageFormat, int)
- [vtkSetMacro](#) (LossyFlag, int)
- [vtkSetMacro](#) (PlanarConfiguration, int)
- [vtkSetMacro](#) (Scale, double)
- [vtkSetMacro](#) (Shift, double)
- [vtkSetStringMacro](#) (SeriesUID)
- [vtkSetStringMacro](#) (StudyUID)
- [vtkTypeMacro](#) (vtkGDCMImageWriter, vtkImageWriter)
- virtual void [Write](#) ()

## Static Public Member Functions

- static [vtkGDCMImageWriter](#) \* [New](#) ()

## Protected Member Functions

- [vtkGDCMImageWriter](#) ()
- [~vtkGDCMImageWriter](#) ()
- virtual char \* [GetFileName](#) ()
- int [WriteGDCMData](#) (vtkImageData \*data, int timeStep)
- void [WriteSlice](#) (vtkImageData \*data)

## 10.379.1 Detailed Description

### Examples

[Convert16BitsTo8Bits.cxx](#), [ConvertMultiFrameToSingleFrame.cxx](#), [ConvertRGBToLuminance.cxx](#), [ConvertSingleBitTo8Bits.cxx](#), [CreateFakePET.cxx](#), [CreateFakeRTDOSE.cxx](#), [HelloActiviz.cs](#), [HelloActiviz2.cs](#), [HelloVTKWorld.cs](#), [HelloVTKWorld.java](#), [HelloVTKWorld2.cs](#), [MagnifyFile.cxx](#), [RefCounting.cs](#), and [gdcmorphoplanes.cxx](#).

## 10.379.2 Member Enumeration Documentation

### 10.379.2.1 CompressionTypes

```
enum vtkGDCMImageWriter::CompressionTypes
```

#### Enumerator

NO_COMPRESSION	
JPEG_COMPRESSION	
JPEG2000_COMPRESSION	
JPEGLS_COMPRESSION	
RLE_COMPRESSION	

## 10.379.3 Constructor & Destructor Documentation

### 10.379.3.1 vtkGDCMImageWriter()

```
vtkGDCMImageWriter::vtkGDCMImageWriter ( ) [protected]
```

### 10.379.3.2 ~vtkGDCMImageWriter()

```
vtkGDCMImageWriter::~~vtkGDCMImageWriter ( ) [protected]
```

## 10.379.4 Member Function Documentation

#### 10.379.4.1 GetDescriptiveName()

```
virtual const char* vtkGDCMImageWriter::GetDescriptiveName ( ) [inline], [virtual]
```

#### 10.379.4.2 GetFileExtensions()

```
virtual const char* vtkGDCMImageWriter::GetFileExtensions ( ) [inline], [virtual]
```

#### 10.379.4.3 GetFileName()

```
virtual char* vtkGDCMImageWriter::GetFileName ( ) [protected], [virtual]
```

#### 10.379.4.4 New()

```
static vtkGDCMImageWriter* vtkGDCMImageWriter::New ( ) [static]
```

##### Examples

[Convert16BitsTo8Bits.cxx](#), [ConvertMultiFrameToSingleFrame.cxx](#), [ConvertRGBToLuminance.cxx](#), [ConvertSingleBitTo8Bits.cxx](#), [CreateFakePET.cxx](#), [CreateFakeRTDOSE.cxx](#), [HelloActiviz.cs](#), [HelloVTKWorld.cs](#), [HelloVTKWorld2.cs](#), [MagnifyFile.cxx](#), [RefCounting.cs](#), and [gdcmorphoplanes.cxx](#).

#### 10.379.4.5 PrintSelf()

```
virtual void vtkGDCMImageWriter::PrintSelf (
    ostream & os,
    vtkIndent indent ) [virtual]
```

#### 10.379.4.6 SetDirectionCosines()

```
virtual void vtkGDCMImageWriter::SetDirectionCosines (
    vtkMatrix4x4 * matrix ) [virtual]
```

##### Examples

[Convert16BitsTo8Bits.cxx](#), [ConvertRGBToLuminance.cxx](#), [ConvertSingleBitTo8Bits.cxx](#), [HelloActiviz2.cs](#), [HelloVTKWorld.cs](#), [HelloVTKWorld.java](#), [MagnifyFile.cxx](#), and [gdcmorphoplanes.cxx](#).

#### 10.379.4.7 SetDirectionCosinesFromImageOrientationPatient()

```
virtual void vtkGDCMImageWriter::SetDirectionCosinesFromImageOrientationPatient (
    const double dircos[6] ) [virtual]
```

#### 10.379.4.8 SetFileNames()

```
virtual void vtkGDCMImageWriter::SetFileNames (
    vtkStringArray * ) [virtual]
```

#### Examples

[ConvertMultiFrameToSingleFrame.cxx](#), and [CreateFakePET.cxx](#).

#### 10.379.4.9 SetMedicalImageProperties()

```
virtual void vtkGDCMImageWriter::SetMedicalImageProperties (
    vtkMedicalImageProperties * ) [virtual]
```

#### Examples

[Convert16BitsTo8Bits.cxx](#), [ConvertRGBToLuminance.cxx](#), [ConvertSingleBitTo8Bits.cxx](#), [HelloActiviz.cs](#), [HelloActiviz2.cs](#), [HelloVTKWorld.cs](#), [HelloVTKWorld.java](#), [MagnifyFile.cxx](#), and [gdcmonthoplanes.cxx](#).

#### 10.379.4.10 vtkBooleanMacro() [1/2]

```
vtkGDCMImageWriter::vtkBooleanMacro (
    FileLowerLeft ,
    int )
```

#### 10.379.4.11 vtkBooleanMacro() [2/2]

```
vtkGDCMImageWriter::vtkBooleanMacro (
    LossyFlag ,
    int )
```



**10.379.4.12 vtkGetMacro()** [1/7]

```
vtkGDCMImageWriter::vtkGetMacro (
    CompressionType ,
    int )
```

**10.379.4.13 vtkGetMacro()** [2/7]

```
vtkGDCMImageWriter::vtkGetMacro (
    FileLowerLeft ,
    int )
```

**10.379.4.14 vtkGetMacro()** [3/7]

```
vtkGDCMImageWriter::vtkGetMacro (
    ImageFormat ,
    int )
```

**10.379.4.15 vtkGetMacro()** [4/7]

```
vtkGDCMImageWriter::vtkGetMacro (
    LossyFlag ,
    int )
```

**10.379.4.16 vtkGetMacro()** [5/7]

```
vtkGDCMImageWriter::vtkGetMacro (
    PlanarConfiguration ,
    int )
```

**10.379.4.17 vtkGetMacro()** [6/7]

```
vtkGDCMImageWriter::vtkGetMacro (
    Scale ,
    double )
```

**10.379.4.18 vtkGetMacro() [7/7]**

```
vtkGDCMImageWriter::vtkGetMacro (
    Shift ,
    double )
```

**10.379.4.19 vtkGetObjectMacro() [1/3]**

```
vtkGDCMImageWriter::vtkGetObjectMacro (
    DirectionCosines ,
    vtkMatrix4x4 )
```

**10.379.4.20 vtkGetObjectMacro() [2/3]**

```
vtkGDCMImageWriter::vtkGetObjectMacro (
    FileNames ,
    vtkStringArray )
```

**10.379.4.21 vtkGetObjectMacro() [3/3]**

```
vtkGDCMImageWriter::vtkGetObjectMacro (
    MedicalImageProperties ,
    vtkMedicalImageProperties )
```

**10.379.4.22 vtkGetStringMacro() [1/2]**

```
vtkGDCMImageWriter::vtkGetStringMacro (
    SeriesUID )
```

**10.379.4.23 vtkGetStringMacro() [2/2]**

```
vtkGDCMImageWriter::vtkGetStringMacro (
    StudyUID )
```

**10.379.4.24 vtkSetMacro()** [1/7]

```
vtkGDCMImageWriter::vtkSetMacro (
    CompressionType ,
    int )
```

**10.379.4.25 vtkSetMacro()** [2/7]

```
vtkGDCMImageWriter::vtkSetMacro (
    FileLowerLeft ,
    int )
```

**10.379.4.26 vtkSetMacro()** [3/7]

```
vtkGDCMImageWriter::vtkSetMacro (
    ImageFormat ,
    int )
```

**10.379.4.27 vtkSetMacro()** [4/7]

```
vtkGDCMImageWriter::vtkSetMacro (
    LossyFlag ,
    int )
```

**10.379.4.28 vtkSetMacro()** [5/7]

```
vtkGDCMImageWriter::vtkSetMacro (
    PlanarConfiguration ,
    int )
```

**10.379.4.29 vtkSetMacro()** [6/7]

```
vtkGDCMImageWriter::vtkSetMacro (
    Scale ,
    double )
```

**10.379.4.30 vtkSetMacro()** [7/7]

```
vtkGDCMImageWriter::vtkSetMacro (
    Shift ,
    double )
```

**10.379.4.31 vtkSetStringMacro()** [1/2]

```
vtkGDCMImageWriter::vtkSetStringMacro (
    SeriesUID )
```

**10.379.4.32 vtkSetStringMacro()** [2/2]

```
vtkGDCMImageWriter::vtkSetStringMacro (
    StudyUID )
```

**10.379.4.33 vtkTypeMacro()**

```
vtkGDCMImageWriter::vtkTypeMacro (
    vtkGDCMImageWriter ,
    vtkImageWriter )
```

**10.379.4.34 Write()**

```
virtual void vtkGDCMImageWriter::Write ( ) [virtual]
```

**Examples**

[Convert16BitsTo8Bits.cxx](#), [ConvertMultiFrameToSingleFrame.cxx](#), [ConvertRGBToLuminance.cxx](#), [ConvertSingleBitTo8Bits.cxx](#), [CreateFakePET.cxx](#), [CreateFakeRTDOSE.cxx](#), [HelloActiviz.cs](#), [HelloActiviz2.cs](#), [HelloVTKWorld.cs](#), [HelloVTKWorld.java](#), [HelloVTKWorld2.cs](#), [MagnifyFile.cxx](#), and [gdcmortoplanes.cxx](#).

### 10.379.4.35 WriteGDCMData()

```
int vtkGDCMImageWriter::WriteGDCMData (
    vtkImageData * data,
    int timeStep ) [protected]
```

### 10.379.4.36 WriteSlice()

```
void vtkGDCMImageWriter::WriteSlice (
    vtkImageData * data ) [protected]
```

The documentation for this class was generated from the following file:

- [vtkGDCMImageWriter.h](#)

## 10.380 vtkGDCMMedicalImageProperties Class Reference

```
#include <vtkGDCMMedicalImageProperties.h>
```

Inheritance diagram for vtkGDCMMedicalImageProperties:

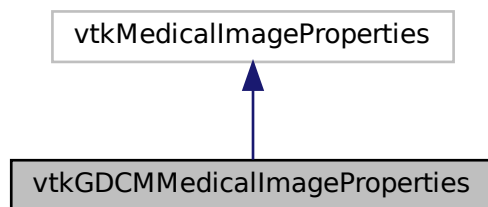

Collaboration diagram for vtkGDCMMedicalImageProperties:

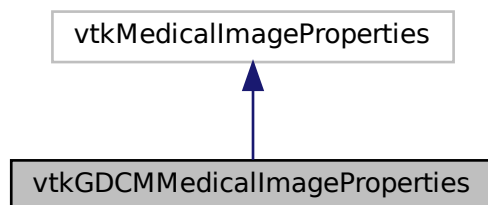

## Public Member Functions

- virtual void [Clear](#) ()
- void [PrintSelf](#) (ostream &os, vtkIndent indent)
- [vtkTypeMacro](#) ([vtkGDCMMedicalImageProperties](#), [vtkMedicalImageProperties](#))

## Static Public Member Functions

- static [vtkGDCMMedicalImageProperties](#) \* [New](#) ()

## Protected Member Functions

- [vtkGDCMMedicalImageProperties](#) ()
- [~vtkGDCMMedicalImageProperties](#) ()
- [gdcM::File](#) const & [GetFile](#) (unsigned int t)
- void [PushBackFile](#) ([gdcM::File](#) const &f)

## Friends

- class [vtkGDCMImageReader](#)
- class [vtkGDCMImageReader2](#)
- class [vtkGDCMImageWriter](#)

## 10.380.1 Constructor & Destructor Documentation

### 10.380.1.1 [vtkGDCMMedicalImageProperties\(\)](#)

```
vtkGDCMMedicalImageProperties::vtkGDCMMedicalImageProperties ( ) [protected]
```

### 10.380.1.2 [~vtkGDCMMedicalImageProperties\(\)](#)

```
vtkGDCMMedicalImageProperties::~~vtkGDCMMedicalImageProperties ( ) [protected]
```

## 10.380.2 Member Function Documentation

### 10.380.2.1 Clear()

```
virtual void vtkGDCMMedicalImageProperties::Clear ( ) [virtual]
```

### 10.380.2.2 GetFile()

```
gdcM::File const& vtkGDCMMedicalImageProperties::GetFile (
    unsigned int t ) [protected]
```

### 10.380.2.3 New()

```
static vtkGDCMMedicalImageProperties* vtkGDCMMedicalImageProperties::New ( ) [static]
```

### 10.380.2.4 PrintSelf()

```
void vtkGDCMMedicalImageProperties::PrintSelf (
    ostream & os,
    vtkIndent indent )
```

### 10.380.2.5 PushBackFile()

```
void vtkGDCMMedicalImageProperties::PushBackFile (
    gdcM::File const & f ) [protected]
```

### 10.380.2.6 vtkTypeMacro()

```
vtkGDCMMedicalImageProperties::vtkTypeMacro (
    vtkGDCMMedicalImageProperties ,
    vtkMedicalImageProperties )
```

## 10.380.3 Friends And Related Function Documentation

### 10.380.3.1 vtkGDCMImageReader

```
friend class vtkGDCMImageReader [friend]
```

### 10.380.3.2 vtkGDCMImageReader2

```
friend class vtkGDCMImageReader2 [friend]
```

### 10.380.3.3 vtkGDCMImageWriter

```
friend class vtkGDCMImageWriter [friend]
```

The documentation for this class was generated from the following file:

- [vtkGDCMMedicalImageProperties.h](#)

## 10.381 vtkGDCMPolyDataReader Class Reference

```
#include <vtkGDCMPolyDataReader.h>
```

Inheritance diagram for vtkGDCMPolyDataReader:

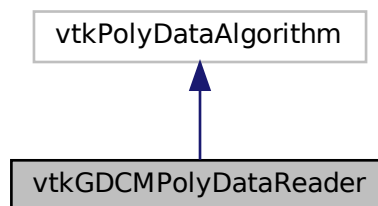



Collaboration diagram for vtkGDCMPolyDataReader:

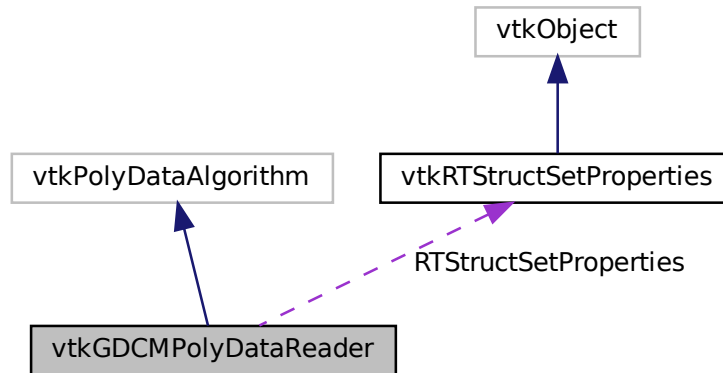

## Public Member Functions

- virtual void [PrintSelf](#) (ostream &os, vtkIndent indent)
- [vtkGetObjectMacro](#) (MedicalImageProperties, vtkMedicalImageProperties)
- [vtkGetObjectMacro](#) (RTStructSetProperties, vtkRTStructSetProperties)
- [vtkGetStringMacro](#) (FileName)
- [vtkSetStringMacro](#) (FileName)
- [vtkTypeMacro](#) (vtkGDCMPolyDataReader, vtkPolyDataAlgorithm)

## Static Public Member Functions

- static [vtkGDCMPolyDataReader \\* New](#) ()

## Protected Member Functions

- [vtkGDCMPolyDataReader](#) ()
- [~vtkGDCMPolyDataReader](#) ()
- void [FillMedicalImageInformation](#) (const [gdcmm::Reader](#) &reader)
- int [RequestData](#) (vtkInformation \*, vtkInformationVector \*\*, vtkInformationVector \*)
- int [RequestData\\_HemodynamicWaveformStorage](#) ([gdcmm::Reader](#) const &reader, vtkInformationVector \*outputVector)
- int [RequestData\\_RTStructureSetStorage](#) ([gdcmm::Reader](#) const &reader, vtkInformationVector \*outputVector)
- int [RequestInformation](#) (vtkInformation \*vtkNotUsed(request), vtkInformationVector \*\*vtkNotUsed(inputVector), vtkInformationVector \*outputVector)
- int [RequestInformation\\_HemodynamicWaveformStorage](#) ([gdcmm::Reader](#) const &reader)
- int [RequestInformation\\_RTStructureSetStorage](#) ([gdcmm::Reader](#) const &reader)

## Protected Attributes

- char \* [FileName](#)
- vtkMedicalImageProperties \* [MedicalImageProperties](#)
- [vtkRTStructSetProperties](#) \* [RTStructSetProperties](#)

### 10.381.1 Detailed Description

#### Examples

[GenerateRTSTRUCT.cxx](#), [gdcmscene.cxx](#), and [rtstructapp.cxx](#).

### 10.381.2 Constructor & Destructor Documentation

#### 10.381.2.1 vtkGDCMPolyDataReader()

```
vtkGDCMPolyDataReader::vtkGDCMPolyDataReader ( ) [protected]
```

#### 10.381.2.2 ~vtkGDCMPolyDataReader()

```
vtkGDCMPolyDataReader::~~vtkGDCMPolyDataReader ( ) [protected]
```

### 10.381.3 Member Function Documentation

#### 10.381.3.1 FillMedicalImageInformation()

```
void vtkGDCMPolyDataReader::FillMedicalImageInformation (
    const gdcm::Reader & reader ) [protected]
```

#### 10.381.3.2 New()

```
static vtkGDCMPolyDataReader\* vtkGDCMPolyDataReader::New ( ) [static]
```

#### Examples

[GenerateRTSTRUCT.cxx](#), [gdcmscene.cxx](#), and [rtstructapp.cxx](#).

### 10.381.3.3 PrintSelf()

```
virtual void vtkGDCMPolyDataReader::PrintSelf (
    ostream & os,
    vtkIndent indent ) [virtual]
```

### 10.381.3.4 RequestData()

```
int vtkGDCMPolyDataReader::RequestData (
    vtkInformation * ,
    vtkInformationVector ** ,
    vtkInformationVector * ) [protected]
```

### 10.381.3.5 RequestData\_HemodynamicWaveformStorage()

```
int vtkGDCMPolyDataReader::RequestData_HemodynamicWaveformStorage (
    gdcM::Reader const & reader,
    vtkInformationVector * outputVector ) [protected]
```

### 10.381.3.6 RequestData\_RTStructureSetStorage()

```
int vtkGDCMPolyDataReader::RequestData_RTStructureSetStorage (
    gdcM::Reader const & reader,
    vtkInformationVector * outputVector ) [protected]
```

### 10.381.3.7 RequestInformation()

```
int vtkGDCMPolyDataReader::RequestInformation (
    vtkInformation * vtkNotUsedrequest,
    vtkInformationVector ** vtkNotUsedinputVector,
    vtkInformationVector * outputVector ) [protected]
```

### 10.381.3.8 RequestInformation\_HemodynamicWaveformStorage()

```
int vtkGDCMPolyDataReader::RequestInformation_HemodynamicWaveformStorage (
    gdcM::Reader const & reader ) [protected]
```

### 10.381.3.9 RequestInformation\_RTStructureSetStorage()

```
int vtkGDCMPolyDataReader::RequestInformation_RTStructureSetStorage (
    gdcM::Reader const & reader ) [protected]
```

### 10.381.3.10 vtkGetObjectMacro() [1/2]

```
vtkGDCMPolyDataReader::vtkGetObjectMacro (
    MedicalImageProperties ,
    vtkMedicalImageProperties )
```

### 10.381.3.11 vtkGetObjectMacro() [2/2]

```
vtkGDCMPolyDataReader::vtkGetObjectMacro (
    RTStructSetProperties ,
    vtkRTStructSetProperties )
```

### 10.381.3.12 vtkGetStringMacro()

```
vtkGDCMPolyDataReader::vtkGetStringMacro (
    FileName )
```

### 10.381.3.13 vtkSetStringMacro()

```
vtkGDCMPolyDataReader::vtkSetStringMacro (
    FileName )
```

### 10.381.3.14 vtkTypeMacro()

```
vtkGDCMPolyDataReader::vtkTypeMacro (
    vtkGDCMPolyDataReader ,
    vtkPolyDataAlgorithm )
```

## 10.381.4 Member Data Documentation

### 10.381.4.1 FileName

```
char* vtkGDCMPolyDataReader::FileName [protected]
```

### 10.381.4.2 MedicalImageProperties

```
vtkMedicalImageProperties* vtkGDCMPolyDataReader::MedicalImageProperties [protected]
```

### 10.381.4.3 RTStructSetProperties

```
vtkRTStructSetProperties* vtkGDCMPolyDataReader::RTStructSetProperties [protected]
```

The documentation for this class was generated from the following file:

- [vtkGDCMPolyDataReader.h](#)

## 10.382 vtkGDCMPolyDataWriter Class Reference

```
#include <vtkGDCMPolyDataWriter.h>
```

Inheritance diagram for vtkGDCMPolyDataWriter:

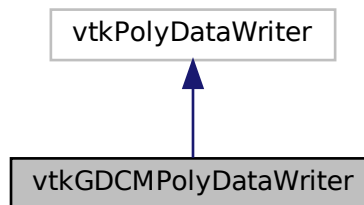

Collaboration diagram for vtkGDCMPolyDataWriter:

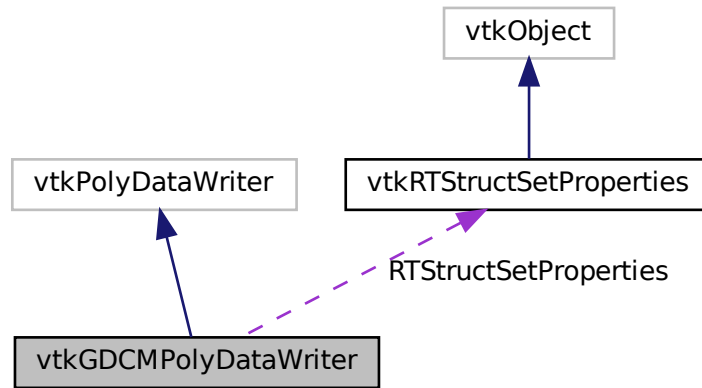

## Public Member Functions

- void [InitializeRTStructSet](#) (vtkStdString inDirectory, vtkStdString inStructLabel, vtkStdString inStructName, vtkStdStringArray \*inROINames, vtkStringArray \*inROIAlgorithmName, vtkStringArray \*inROIType)
- virtual void [PrintSelf](#) (ostream &os, vtkIndent indent)
- virtual void [SetMedicalImageProperties](#) (vtkMedicalImageProperties \*pd)
- void [SetNumberOfInputPorts](#) (int n)
- virtual void [SetRTStructSetProperties](#) (vtkRTStructSetProperties \*pd)
- [vtkTypeMacro](#) (vtkGDCMPolyDataWriter, vtkPolyDataWriter)

## Static Public Member Functions

- static [vtkGDCMPolyDataWriter \\* New](#) ()

## Protected Member Functions

- [vtkGDCMPolyDataWriter](#) ()
- [~vtkGDCMPolyDataWriter](#) ()
- void [WriteData](#) ()
- void [WriteRTSTRUCTData](#) (gdcM::File &file, int num)
- void [WriteRTSTRUCTInfo](#) (gdcM::File &file)

## Protected Attributes

- vtkMedicalImageProperties \* [MedicalImageProperties](#)
- [vtkRTStructSetProperties](#) \* [RTStructSetProperties](#)

## 10.382.1 Detailed Description

### Examples

[GenerateRTSTRUCT.cxx](#), and [rtstructapp.cxx](#).

## 10.382.2 Constructor & Destructor Documentation

### 10.382.2.1 vtkGDCMPolyDataWriter()

```
vtkGDCMPolyDataWriter::vtkGDCMPolyDataWriter ( ) [protected]
```

### 10.382.2.2 ~vtkGDCMPolyDataWriter()

```
vtkGDCMPolyDataWriter::~~vtkGDCMPolyDataWriter ( ) [protected]
```

## 10.382.3 Member Function Documentation

### 10.382.3.1 InitializeRTStructSet()

```
void vtkGDCMPolyDataWriter::InitializeRTStructSet (
    vtkStdString inDirectory,
    vtkStdString inStructLabel,
    vtkStdString inStructName,
    vtkStringArray * inROINames,
    vtkStringArray * inROIAlgorithmName,
    vtkStringArray * inROIType )
```

### Examples

[GenerateRTSTRUCT.cxx](#).

### 10.382.3.2 New()

```
static vtkGDCMPolyDataWriter* vtkGDCMPolyDataWriter::New ( ) [static]
```

#### Examples

[GenerateRTSTRUCT.cxx](#), and [rtstructapp.cxx](#).

### 10.382.3.3 PrintSelf()

```
virtual void vtkGDCMPolyDataWriter::PrintSelf (
    ostream & os,
    vtkIndent indent ) [virtual]
```

### 10.382.3.4 SetMedicalImageProperties()

```
virtual void vtkGDCMPolyDataWriter::SetMedicalImageProperties (
    vtkMedicalImageProperties * pd ) [virtual]
```

#### Examples

[GenerateRTSTRUCT.cxx](#), and [rtstructapp.cxx](#).

### 10.382.3.5 SetNumberOfInputPorts()

```
void vtkGDCMPolyDataWriter::SetNumberOfInputPorts (
    int n )
```

#### Examples

[GenerateRTSTRUCT.cxx](#), and [rtstructapp.cxx](#).



### 10.382.3.6 SetRTStructSetProperties()

```
virtual void vtkGDCMPolyDataWriter::SetRTStructSetProperties (
    vtkRTStructSetProperties * pd ) [virtual]
```

#### Examples

[GenerateRTSTRUCT.cxx](#), and [rtstructapp.cxx](#).

### 10.382.3.7 vtkTypeMacro()

```
vtkGDCMPolyDataWriter::vtkTypeMacro (
    vtkGDCMPolyDataWriter ,
    vtkPolyDataWriter )
```

### 10.382.3.8 WriteData()

```
void vtkGDCMPolyDataWriter::WriteData ( ) [protected]
```

### 10.382.3.9 WriteRTSTRUCTData()

```
void vtkGDCMPolyDataWriter::WriteRTSTRUCTData (
    gdcM::File & file,
    int num ) [protected]
```

### 10.382.3.10 WriteRTSTRUCTInfo()

```
void vtkGDCMPolyDataWriter::WriteRTSTRUCTInfo (
    gdcM::File & file ) [protected]
```

## 10.382.4 Member Data Documentation

### 10.382.4.1 MedicalImageProperties

```
vtkMedicalImageProperties* vtkGDCMPolyDataWriter::MedicalImageProperties [protected]
```

### 10.382.4.2 RTStructSetProperties

```
vtkRTStructSetProperties* vtkGDCMPolyDataWriter::RTStructSetProperties [protected]
```

The documentation for this class was generated from the following file:

- [vtkGDCMPolyDataWriter.h](#)

## 10.383 vtkGDCMTesting Class Reference

```
#include <vtkGDCMTesting.h>
```

Inheritance diagram for vtkGDCMTesting:

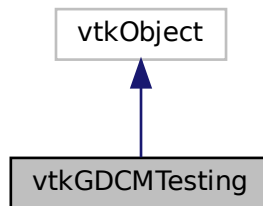

Collaboration diagram for vtkGDCMTesting:

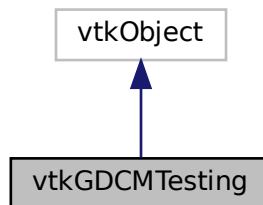

## Public Types

- typedef const char \*const (\* [MD5MetalImagesType](#))[3]

## Public Member Functions

- void [PrintSelf](#) (ostream &os, vtkIndent indent)
- [vtkTypeMacro](#) ([vtkGDCMTesting](#), vtkObject)

## Static Public Member Functions

- static const char \* [GetGDCMDataRoot](#) ()
- static const char \*const \* [GetMD5MetalImage](#) (unsigned int file)
- static const char \* [GetMHDMD5FromFile](#) (const char \*filepath)
- static unsigned int [GetNumberOfMD5MetalImages](#) ()
- static const char \* [GetRAWMD5FromFile](#) (const char \*filepath)
- static const char \* [GetVTKDataRoot](#) ()
- static [vtkGDCMTesting](#) \* [New](#) ()

## Protected Member Functions

- [vtkGDCMTesting](#) ()
- [~vtkGDCMTesting](#) ()

### 10.383.1 Detailed Description

#### Examples

[HelloActiviz5.cs](#), [HelloVTKWorld2.cs](#), [MetalImageMD5Activiz.cs](#), [ReadSeriesIntoVTK.java](#), and [RefCounting.cs](#).

### 10.383.2 Member Typedef Documentation

#### 10.383.2.1 MD5MetalImagesType

```
typedef const char* const (* vtkGDCMTesting::MD5MetaImagesType) [3]
```

### 10.383.3 Constructor & Destructor Documentation

### 10.383.3.1 vtkGDCMTesting()

```
vtkGDCMTesting::vtkGDCMTesting ( ) [protected]
```

### 10.383.3.2 ~vtkGDCMTesting()

```
vtkGDCMTesting::~~vtkGDCMTesting ( ) [protected]
```

## 10.383.4 Member Function Documentation

### 10.383.4.1 GetGDCMDataRoot()

```
static const char* vtkGDCMTesting::GetGDCMDataRoot ( ) [static]
```

#### Examples

[HelloActiviz5.cs](#), and [ReadSeriesIntoVTK.java](#).

### 10.383.4.2 GetMD5MetaImage()

```
static const char* const* vtkGDCMTesting::GetMD5MetaImage (
    unsigned int file ) [static]
```

### 10.383.4.3 GetMHDMD5FromFile()

```
static const char* vtkGDCMTesting::GetMHDMD5FromFile (
    const char * filepath ) [static]
```

#### Examples

[MetaImageMD5Activiz.cs](#).

#### 10.383.4.4 GetNumberOfMD5MetaImages()

```
static unsigned int vtkGDCMTesting::GetNumberOfMD5MetaImages ( ) [static]
```

#### 10.383.4.5 GetRAWMD5FromFile()

```
static const char* vtkGDCMTesting::GetRAWMD5FromFile (
    const char * filepath ) [static]
```

##### Examples

[MetaImageMD5Activiz.cs](#).

#### 10.383.4.6 GetVTKDataRoot()

```
static const char* vtkGDCMTesting::GetVTKDataRoot ( ) [static]
```

##### Examples

[HelloActiviz5.cs](#), and [HelloVTKWorld2.cs](#).

#### 10.383.4.7 New()

```
static vtkGDCMTesting\* vtkGDCMTesting::New ( ) [static]
```

##### Examples

[RefCounting.cs](#).

#### 10.383.4.8 PrintSelf()

```
void vtkGDCMTesting::PrintSelf (
    ostream & os,
    vtkIndent indent )
```

### 10.383.4.9 vtkTypeMacro()

```
vtkGDCMTesting::vtkTypeMacro (
    vtkGDCMTesting ,
    vtkObject )
```

The documentation for this class was generated from the following file:

- [vtkGDCMTesting.h](#)

## 10.384 vtkGDCMThreadedImageReader Class Reference

```
#include <vtkGDCMThreadedImageReader.h>
```

Inheritance diagram for vtkGDCMThreadedImageReader:

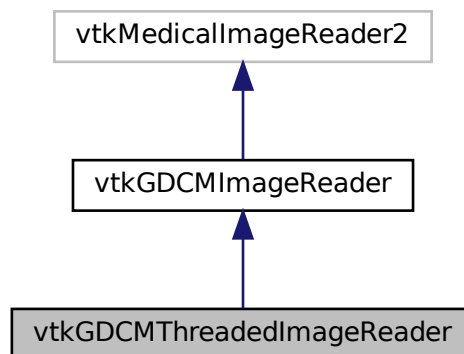

Collaboration diagram for vtkGDCMThreadedImageReader:

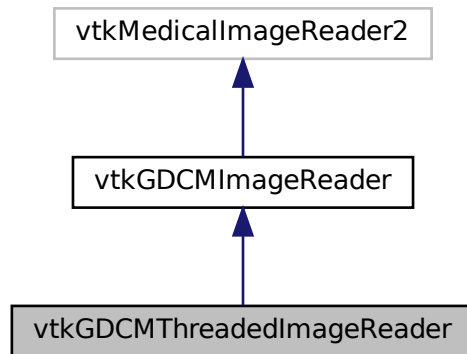

## Public Member Functions

- virtual void [PrintSelf](#) (ostream &os, vtkIndent indent)
- [vtkBooleanMacro](#) (UseShiftScale, int)
- [vtkGetMacro](#) (UseShiftScale, int)
- [vtkSetMacro](#) (Scale, double)
- [vtkSetMacro](#) (Shift, double)
- [vtkSetMacro](#) (UseShiftScale, int)
- [vtkTypeMacro](#) (vtkGDCMThreadedImageReader, vtkGDCMImageReader)

## Static Public Member Functions

- static [vtkGDCMThreadedImageReader \\* New](#) ()

## Protected Member Functions

- [vtkGDCMThreadedImageReader](#) ()
- [~vtkGDCMThreadedImageReader](#) ()
- void [ExecuteData](#) (vtkDataObject \*out)
- void [ExecuteInformation](#) ()
- void [ReadFiles](#) (unsigned int nfiles, const char \*filenames[])
- void [RequestDataCompat](#) ()

## Additional Inherited Members

### 10.384.1 Constructor & Destructor Documentation

### 10.384.1.1 vtkGDCMThreadedImageReader()

```
vtkGDCMThreadedImageReader::vtkGDCMThreadedImageReader ( ) [protected]
```

### 10.384.1.2 ~vtkGDCMThreadedImageReader()

```
vtkGDCMThreadedImageReader::~~vtkGDCMThreadedImageReader ( ) [protected]
```

## 10.384.2 Member Function Documentation

### 10.384.2.1 ExecuteData()

```
void vtkGDCMThreadedImageReader::ExecuteData (
    vtkDataObject * out ) [protected]
```

### 10.384.2.2 ExecuteInformation()

```
void vtkGDCMThreadedImageReader::ExecuteInformation ( ) [protected]
```

### 10.384.2.3 New()

```
static vtkGDCMThreadedImageReader\* vtkGDCMThreadedImageReader::New ( ) [static]
```

### 10.384.2.4 PrintSelf()

```
virtual void vtkGDCMThreadedImageReader::PrintSelf (
    ostream & os,
    vtkIndent indent ) [virtual]
```

Reimplemented from [vtkGDCMImageReader](#).



### 10.384.2.5 ReadFiles()

```
void vtkGDCMThreadedImageReader::ReadFiles (
    unsigned int nfiles,
    const char * filenames[] ) [protected]
```

### 10.384.2.6 RequestDataCompat()

```
void vtkGDCMThreadedImageReader::RequestDataCompat ( ) [protected]
```

### 10.384.2.7 vtkBooleanMacro()

```
vtkGDCMThreadedImageReader::vtkBooleanMacro (
    UseShiftScale ,
    int )
```

### 10.384.2.8 vtkGetMacro()

```
vtkGDCMThreadedImageReader::vtkGetMacro (
    UseShiftScale ,
    int )
```

### 10.384.2.9 vtkSetMacro() [1/3]

```
vtkGDCMThreadedImageReader::vtkSetMacro (
    Scale ,
    double )
```

### 10.384.2.10 vtkSetMacro() [2/3]

```
vtkGDCMThreadedImageReader::vtkSetMacro (
    Shift ,
    double )
```

### 10.384.2.11 `vtkSetMacro()` [3/3]

```
vtkGDCMThreadedImageReader::vtkSetMacro (
    UseShiftScale ,
    int )
```

### 10.384.2.12 `vtkTypeMacro()`

```
vtkGDCMThreadedImageReader::vtkTypeMacro (
    vtkGDCMThreadedImageReader ,
    vtkGDCMImageReader )
```

The documentation for this class was generated from the following file:

- [vtkGDCMThreadedImageReader.h](#)

## 10.385 `vtkGDCMThreadedImageReader2` Class Reference

```
#include <vtkGDCMThreadedImageReader2.h>
```

Inheritance diagram for `vtkGDCMThreadedImageReader2`:

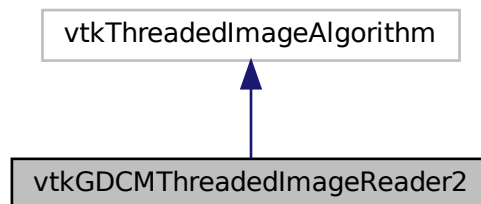

Collaboration diagram for vtkGDCMThreadedImageReader2:

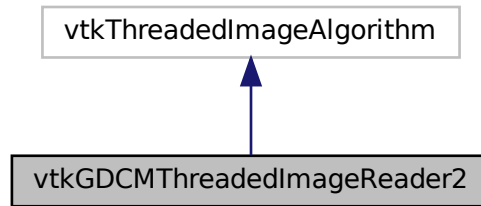

## Public Member Functions

- virtual const char \* [GetFileName](#) (int i=0)
- virtual void [PrintSelf](#) (ostream &os, vtkIndent indent)
- virtual void [SetFileName](#) (const char \*filename)
- virtual void [SetFileNames](#) (vtkStringArray \*)
- int [SplitExtent](#) (int splitExt[6], int startExt[6], int num, int total)
- [vtkBooleanMacro](#) (FileLowerLeft, int)
- [vtkBooleanMacro](#) (LoadOverlays, int)
- [vtkBooleanMacro](#) (UseShiftScale, int)
- [vtkGetMacro](#) (DataScalarType, int)
- [vtkGetMacro](#) (FileLowerLeft, int)
- [vtkGetMacro](#) (LoadOverlays, int)
- [vtkGetMacro](#) (NumberOfOverlays, int)
- [vtkGetMacro](#) (NumberOfScalarComponents, int)
- [vtkGetMacro](#) (Scale, double)
- [vtkGetMacro](#) (Shift, double)
- [vtkGetMacro](#) (UseShiftScale, int)
- [vtkGetObjectMacro](#) (FileNames, vtkStringArray)
- [vtkGetVector3Macro](#) (DataOrigin, double)
- [vtkGetVector3Macro](#) (DataSpacing, double)
- [vtkGetVector6Macro](#) (DataExtent, int)
- [vtkSetMacro](#) (DataScalarType, int)
- [vtkSetMacro](#) (FileLowerLeft, int)
- [vtkSetMacro](#) (LoadOverlays, int)
- [vtkSetMacro](#) (NumberOfScalarComponents, int)
- [vtkSetMacro](#) (Scale, double)
- [vtkSetMacro](#) (Shift, double)
- [vtkSetMacro](#) (UseShiftScale, int)
- [vtkSetVector3Macro](#) (DataOrigin, double)
- [vtkSetVector3Macro](#) (DataSpacing, double)
- [vtkSetVector6Macro](#) (DataExtent, int)
- [vtkTypeMacro](#) (vtkGDCMThreadedImageReader2, vtkThreadedImageAlgorithm)

## Static Public Member Functions

- static [vtkGDCMThreadedImageReader2](#) \* [New](#) ()

## Protected Member Functions

- [vtkGDCMThreadedImageReader2](#) ()
- [~vtkGDCMThreadedImageReader2](#) ()
- int [RequestInformation](#) (vtkInformation \*request, vtkInformationVector \*\*inputVector, vtkInformationVector \*outputVector)
- void [ThreadedRequestData](#) (vtkInformation \*request, vtkInformationVector \*\*inputVector, vtkInformationVector \*outputVector, vtkImageData \*\*\*inData, vtkImageData \*\*outData, int outExt[6], int id)

## 10.385.1 Constructor & Destructor Documentation

### 10.385.1.1 [vtkGDCMThreadedImageReader2\(\)](#)

`vtkGDCMThreadedImageReader2::vtkGDCMThreadedImageReader2 ( ) [protected]`

### 10.385.1.2 [~vtkGDCMThreadedImageReader2\(\)](#)

`vtkGDCMThreadedImageReader2::~~vtkGDCMThreadedImageReader2 ( ) [protected]`

## 10.385.2 Member Function Documentation

### 10.385.2.1 [GetFileName\(\)](#)

`virtual const char* vtkGDCMThreadedImageReader2::GetFileName ( int i = 0 ) [virtual]`

### 10.385.2.2 [New\(\)](#)

`static vtkGDCMThreadedImageReader2\* vtkGDCMThreadedImageReader2::New ( ) [static]`

### 10.385.2.3 PrintSelf()

```
virtual void vtkGDCMThreadedImageReader2::PrintSelf (
    ostream & os,
    vtkIndent indent ) [virtual]
```

### 10.385.2.4 RequestInformation()

```
int vtkGDCMThreadedImageReader2::RequestInformation (
    vtkInformation * request,
    vtkInformationVector ** inputVector,
    vtkInformationVector * outputVector ) [protected]
```

### 10.385.2.5 SetFileName()

```
virtual void vtkGDCMThreadedImageReader2::SetFileName (
    const char * filename ) [virtual]
```

### 10.385.2.6 SetFileNames()

```
virtual void vtkGDCMThreadedImageReader2::SetFileNames (
    vtkStringArray * ) [virtual]
```

### 10.385.2.7 SplitExtent()

```
int vtkGDCMThreadedImageReader2::SplitExtent (
    int splitExt[6],
    int startExt[6],
    int num,
    int total )
```

### 10.385.2.8 ThreadedRequestData()

```
void vtkGDCMThreadedImageReader2::ThreadedRequestData (
    vtkInformation * request,
    vtkInformationVector ** inputVector,
    vtkInformationVector * outputVector,
    vtkImageData *** inData,
    vtkImageData ** outData,
    int outExt[6],
    int id ) [protected]
```

### 10.385.2.9 vtkBooleanMacro() [1/3]

```
vtkGDCMThreadedImageReader2::vtkBooleanMacro (
    FileLowerLeft ,
    int )
```

### 10.385.2.10 vtkBooleanMacro() [2/3]

```
vtkGDCMThreadedImageReader2::vtkBooleanMacro (
    LoadOverlays ,
    int )
```

### 10.385.2.11 vtkBooleanMacro() [3/3]

```
vtkGDCMThreadedImageReader2::vtkBooleanMacro (
    UseShiftScale ,
    int )
```

### 10.385.2.12 vtkGetMacro() [1/8]

```
vtkGDCMThreadedImageReader2::vtkGetMacro (
    DataScalarType ,
    int )
```

**10.385.2.13 vtkGetMacro()** [2/8]

```
vtkGDCMThreadedImageReader2::vtkGetMacro (
    FileLowerLeft ,
    int )
```

**10.385.2.14 vtkGetMacro()** [3/8]

```
vtkGDCMThreadedImageReader2::vtkGetMacro (
    LoadOverlays ,
    int )
```

**10.385.2.15 vtkGetMacro()** [4/8]

```
vtkGDCMThreadedImageReader2::vtkGetMacro (
    NumberOfOverlays ,
    int )
```

**10.385.2.16 vtkGetMacro()** [5/8]

```
vtkGDCMThreadedImageReader2::vtkGetMacro (
    NumberOfScalarComponents ,
    int )
```

**10.385.2.17 vtkGetMacro()** [6/8]

```
vtkGDCMThreadedImageReader2::vtkGetMacro (
    Scale ,
    double )
```

**10.385.2.18 vtkGetMacro()** [7/8]

```
vtkGDCMThreadedImageReader2::vtkGetMacro (
    Shift ,
    double )
```

**10.385.2.19 vtkGetMacro()** [8/8]

```
vtkGDCMThreadedImageReader2::vtkGetMacro (
    UseShiftScale ,
    int )
```

**10.385.2.20 vtkGetObjectMacro()**

```
vtkGDCMThreadedImageReader2::vtkGetObjectMacro (
    FileNames ,
    vtkStringArray )
```

**10.385.2.21 vtkGetVector3Macro()** [1/2]

```
vtkGDCMThreadedImageReader2::vtkGetVector3Macro (
    DataOrigin ,
    double )
```

**10.385.2.22 vtkGetVector3Macro()** [2/2]

```
vtkGDCMThreadedImageReader2::vtkGetVector3Macro (
    DataSpacing ,
    double )
```

**10.385.2.23 vtkGetVector6Macro()**

```
vtkGDCMThreadedImageReader2::vtkGetVector6Macro (
    DataExtent ,
    int )
```

**10.385.2.24 vtkSetMacro()** [1/7]

```
vtkGDCMThreadedImageReader2::vtkSetMacro (
    DataScalarType ,
    int )
```



**10.385.2.25 vtkSetMacro()** [2/7]

```
vtkGDCMThreadedImageReader2::vtkSetMacro (
    FileLowerLeft ,
    int )
```

**10.385.2.26 vtkSetMacro()** [3/7]

```
vtkGDCMThreadedImageReader2::vtkSetMacro (
    LoadOverlays ,
    int )
```

**10.385.2.27 vtkSetMacro()** [4/7]

```
vtkGDCMThreadedImageReader2::vtkSetMacro (
    NumberOfScalarComponents ,
    int )
```

**10.385.2.28 vtkSetMacro()** [5/7]

```
vtkGDCMThreadedImageReader2::vtkSetMacro (
    Scale ,
    double )
```

**10.385.2.29 vtkSetMacro()** [6/7]

```
vtkGDCMThreadedImageReader2::vtkSetMacro (
    Shift ,
    double )
```

**10.385.2.30 vtkSetMacro()** [7/7]

```
vtkGDCMThreadedImageReader2::vtkSetMacro (
    UseShiftScale ,
    int )
```

**10.385.2.31 vtkSetVector3Macro()** [1/2]

```
vtkGDCMThreadedImageReader2::vtkSetVector3Macro (
    DataOrigin ,
    double )
```

**10.385.2.32 vtkSetVector3Macro()** [2/2]

```
vtkGDCMThreadedImageReader2::vtkSetVector3Macro (
    DataSpacing ,
    double )
```

**10.385.2.33 vtkSetVector6Macro()**

```
vtkGDCMThreadedImageReader2::vtkSetVector6Macro (
    DataExtent ,
    int )
```

**10.385.2.34 vtkTypeMacro()**

```
vtkGDCMThreadedImageReader2::vtkTypeMacro (
    vtkGDCMThreadedImageReader2 ,
    vtkThreadedImageAlgorithm )
```

The documentation for this class was generated from the following file:

- [vtkGDCMThreadedImageReader2.h](#)

## 10.386 vtkImageColorViewer Class Reference

```
#include <vtkImageColorViewer.h>
```

Inheritance diagram for vtkImageColorViewer:

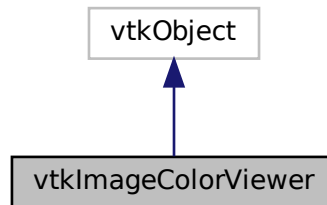

Collaboration diagram for vtkImageColorViewer:

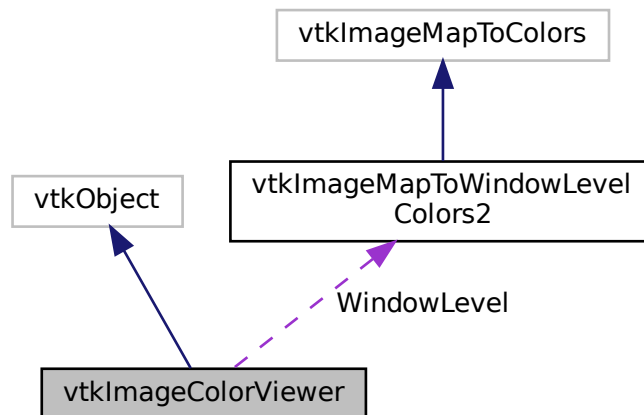

### Public Types

- enum {  
    SLICE\_ORIENTATION\_YZ = 0 ,  
    SLICE\_ORIENTATION\_XZ = 1 ,  
    SLICE\_ORIENTATION\_XY = 2 }

## Public Member Functions

- virtual void [AddInput](#) (vtkImageData \*input)
- virtual void [AddInputConnection](#) (vtkAlgorithmOutput \*input)
- virtual double [GetColorLevel](#) ()
- virtual double [GetColorWindow](#) ()
- virtual vtkImageData \* [GetInput](#) ()
- virtual int [GetOffScreenRendering](#) ()
- double [GetOverlayVisibility](#) ()
- virtual int \* [GetPosition](#) ()
- virtual int \* [GetSize](#) ()
- virtual int [GetSliceMax](#) ()
- virtual int [GetSliceMin](#) ()
- virtual int \* [GetSliceRange](#) ()
- virtual void [GetSliceRange](#) (int &min, int &max)
- virtual void [GetSliceRange](#) (int range[2])
- virtual const char \* [GetWindowName](#) ()
- void [PrintSelf](#) (ostream &os, vtkIndent indent)
- virtual void [Render](#) (void)
- virtual void [SetColorLevel](#) (double s)
- virtual void [SetColorWindow](#) (double s)
- virtual void [SetDisplayId](#) (void \*a)
- virtual void [SetInput](#) (vtkImageData \*in)
- virtual void [SetInputConnection](#) (vtkAlgorithmOutput \*input)
- virtual void [SetOffScreenRendering](#) (int)
- void [SetOverlayVisibility](#) (double vis)
- virtual void [SetParentId](#) (void \*a)
- virtual void [SetPosition](#) (int a, int b)
- virtual void [SetPosition](#) (int a[2])
- virtual void [SetRenderer](#) (vtkRenderer \*arg)
- virtual void [SetRenderWindow](#) (vtkRenderWindow \*arg)
- virtual void [SetSize](#) (int a, int b)
- virtual void [SetSize](#) (int a[2])
- virtual void [SetSlice](#) (int s)
- virtual void [SetSliceOrientation](#) (int orientation)
- virtual void [SetSliceOrientationToXY](#) ()
- virtual void [SetSliceOrientationToXZ](#) ()
- virtual void [SetSliceOrientationToYZ](#) ()
- virtual void [SetupInteractor](#) (vtkRenderWindowInteractor \*)
- virtual void [SetWindowId](#) (void \*a)
- virtual void [UpdateDisplayExtent](#) ()
- [VTK\\_LEGACY](#) (int GetWholeZMax())
- [VTK\\_LEGACY](#) (int GetWholeZMin())
- [VTK\\_LEGACY](#) (int GetZSlice())
- [VTK\\_LEGACY](#) (void SetZSlice(int))
- [vtkBooleanMacro](#) (OffScreenRendering, int)
- [vtkGetMacro](#) (Slice, int)
- [vtkGetMacro](#) (SliceOrientation, int)
- [vtkGetObjectMacro](#) (ImageActor, vtkImageActor)
- [vtkGetObjectMacro](#) (InteractorStyle, vtkInteractorStyleImage)
- [vtkGetObjectMacro](#) (Renderer, vtkRenderer)
- [vtkGetObjectMacro](#) (RenderWindow, vtkRenderWindow)
- [vtkGetObjectMacro](#) (WindowLevel, vtkImageMapToWindowLevelColors2)
- [vtkTypeMacro](#) (vtkImageColorViewer, vtkObject)

## Static Public Member Functions

- static [vtkImageColorViewer](#) \* [New](#) ()

## Protected Member Functions

- [vtkImageColorViewer](#) ()
- [~vtkImageColorViewer](#) ()
- virtual void [InstallPipeline](#) ()
- virtual void [UnInstallPipeline](#) ()
- virtual void [UpdateOrientation](#) ()

## Protected Attributes

- int [FirstRender](#)
- [vtkImageActor](#) \* [ImageActor](#)
- [vtkRenderWindowInteractor](#) \* [Interactor](#)
- [vtkInteractorStyleImage](#) \* [InteractorStyle](#)
- [vtkImageActor](#) \* [OverlayImageActor](#)
- [vtkRenderer](#) \* [Renderer](#)
- [vtkRenderWindow](#) \* [RenderWindow](#)
- int [Slice](#)
- int [SliceOrientation](#)
- [vtkImageMapToWindowLevelColors2](#) \* [WindowLevel](#)

## Friends

- class [vtkImageColorViewerCallback](#)

### 10.386.1 Detailed Description

#### Examples

[gdcmrionplan.cxx](#), and [gdcmrtpian.cxx](#).

### 10.386.2 Member Enumeration Documentation

#### 10.386.2.1 anonymous enum

anonymous enum

## Enumerator

SLICE_ORIENTATION_YZ	
SLICE_ORIENTATION_XZ	
SLICE_ORIENTATION_XY	

### 10.386.3 Constructor & Destructor Documentation

#### 10.386.3.1 vtkImageColorViewer()

```
vtkImageColorViewer::vtkImageColorViewer ( ) [protected]
```

#### 10.386.3.2 ~vtkImageColorViewer()

```
vtkImageColorViewer::~~vtkImageColorViewer ( ) [protected]
```

### 10.386.4 Member Function Documentation

#### 10.386.4.1 AddInput()

```
virtual void vtkImageColorViewer::AddInput (
    vtkImageData * input ) [virtual]
```

#### 10.386.4.2 AddInputConnection()

```
virtual void vtkImageColorViewer::AddInputConnection (
    vtkAlgorithmOutput * input ) [virtual]
```

**10.386.4.3 GetColorLevel()**

```
virtual double vtkImageColorViewer::GetColorLevel ( ) [virtual]
```

**10.386.4.4 GetColorWindow()**

```
virtual double vtkImageColorViewer::GetColorWindow ( ) [virtual]
```

**10.386.4.5 GetInput()**

```
virtual vtkImageData* vtkImageColorViewer::GetInput ( ) [virtual]
```

**10.386.4.6 GetOffScreenRendering()**

```
virtual int vtkImageColorViewer::GetOffScreenRendering ( ) [virtual]
```

**10.386.4.7 GetOverlayVisibility()**

```
double vtkImageColorViewer::GetOverlayVisibility ( )
```

**10.386.4.8 GetPosition()**

```
virtual int* vtkImageColorViewer::GetPosition ( ) [virtual]
```

**10.386.4.9 GetSize()**

```
virtual int* vtkImageColorViewer::GetSize ( ) [virtual]
```

**10.386.4.10 GetSliceMax()**

```
virtual int vtkImageColorViewer::GetSliceMax ( ) [virtual]
```

**10.386.4.11 GetSliceMin()**

```
virtual int vtkImageColorViewer::GetSliceMin ( ) [virtual]
```

**10.386.4.12 GetSliceRange() [1/3]**

```
virtual int* vtkImageColorViewer::GetSliceRange ( ) [virtual]
```

**10.386.4.13 GetSliceRange() [2/3]**

```
virtual void vtkImageColorViewer::GetSliceRange (
    int & min,
    int & max ) [virtual]
```

**10.386.4.14 GetSliceRange() [3/3]**

```
virtual void vtkImageColorViewer::GetSliceRange (
    int range[2] ) [inline], [virtual]
```

**10.386.4.15 GetWindowName()**

```
virtual const char* vtkImageColorViewer::GetWindowName ( ) [virtual]
```

**10.386.4.16 InstallPipeline()**

```
virtual void vtkImageColorViewer::InstallPipeline ( ) [protected], [virtual]
```



#### 10.386.4.17 New()

```
static vtkImageColorViewer* vtkImageColorViewer::New ( ) [static]
```

##### Examples

[gdcmrptionplan.cxx](#), and [gdcmrtpian.cxx](#).

#### 10.386.4.18 PrintSelf()

```
void vtkImageColorViewer::PrintSelf (
    ostream & os,
    vtkIndent indent )
```

#### 10.386.4.19 Render()

```
virtual void vtkImageColorViewer::Render (
    void ) [virtual]
```

##### Examples

[gdcmrptionplan.cxx](#), and [gdcmrtpian.cxx](#).

#### 10.386.4.20 SetColorLevel()

```
virtual void vtkImageColorViewer::SetColorLevel (
    double s ) [virtual]
```

#### 10.386.4.21 SetColorWindow()

```
virtual void vtkImageColorViewer::SetColorWindow (
    double s ) [virtual]
```

**10.386.4.22 SetDisplayId()**

```
virtual void vtkImageColorViewer::SetDisplayId (
    void * a ) [virtual]
```

**10.386.4.23 SetInput()**

```
virtual void vtkImageColorViewer::SetInput (
    vtkImageData * in ) [virtual]
```

**Examples**

[gdcmrtionplan.cxx](#), and [gdcmrtplan.cxx](#).

**10.386.4.24 SetInputConnection()**

```
virtual void vtkImageColorViewer::SetInputConnection (
    vtkAlgorithmOutput * input ) [virtual]
```

**10.386.4.25 SetOffScreenRendering()**

```
virtual void vtkImageColorViewer::SetOffScreenRendering (
    int ) [virtual]
```

**10.386.4.26 SetOverlayVisibility()**

```
void vtkImageColorViewer::SetOverlayVisibility (
    double vis )
```

**10.386.4.27 SetParentId()**

```
virtual void vtkImageColorViewer::SetParentId (
    void * a ) [virtual]
```

**10.386.4.28 SetPosition() [1/2]**

```
virtual void vtkImageColorViewer::SetPosition (
    int a,
    int b ) [virtual]
```

**10.386.4.29 SetPosition() [2/2]**

```
virtual void vtkImageColorViewer::SetPosition (
    int a[2] ) [inline], [virtual]
```

References SetPosition().

Referenced by SetPosition().

**10.386.4.30 SetRenderer()**

```
virtual void vtkImageColorViewer::SetRenderer (
    vtkRenderer * arg ) [virtual]
```

**10.386.4.31 SetRenderWindow()**

```
virtual void vtkImageColorViewer::SetRenderWindow (
    vtkRenderWindow * arg ) [virtual]
```

**10.386.4.32 SetSize() [1/2]**

```
virtual void vtkImageColorViewer::SetSize (
    int a,
    int b ) [virtual]
```

**Examples**

[gdcmrtonplan.cxx](#), and [gdcmrplan.cxx](#).

**10.386.4.33 SetSize() [2/2]**

```
virtual void vtkImageColorViewer::SetSize (
    int a[2] ) [inline], [virtual]
```

References SetSize().

Referenced by SetSize().

**10.386.4.34 SetSlice()**

```
virtual void vtkImageColorViewer::SetSlice (
    int s ) [virtual]
```

**10.386.4.35 SetSliceOrientation()**

```
virtual void vtkImageColorViewer::SetSliceOrientation (
    int orientation ) [virtual]
```

**10.386.4.36 SetSliceOrientationToXY()**

```
virtual void vtkImageColorViewer::SetSliceOrientationToXY ( ) [inline], [virtual]
```

References SLICE\_ORIENTATION\_XY.

**10.386.4.37 SetSliceOrientationToXZ()**

```
virtual void vtkImageColorViewer::SetSliceOrientationToXZ ( ) [inline], [virtual]
```

References SLICE\_ORIENTATION\_XZ.

**10.386.4.38 SetSliceOrientationToYZ()**

```
virtual void vtkImageColorViewer::SetSliceOrientationToYZ ( ) [inline], [virtual]
```

References SLICE\_ORIENTATION\_YZ.

#### 10.386.4.39 SetupInteractor()

```
virtual void vtkImageColorViewer::SetupInteractor (
    vtkRenderWindowInteractor * ) [virtual]
```

#### Examples

[gdcmrtonplan.cxx](#), and [gdcmrplan.cxx](#).

#### 10.386.4.40 SetWindowId()

```
virtual void vtkImageColorViewer::SetWindowId (
    void * a ) [virtual]
```

#### 10.386.4.41 UnInstallPipeline()

```
virtual void vtkImageColorViewer::UnInstallPipeline ( ) [protected], [virtual]
```

#### 10.386.4.42 UpdateDisplayExtent()

```
virtual void vtkImageColorViewer::UpdateDisplayExtent ( ) [virtual]
```

#### 10.386.4.43 UpdateOrientation()

```
virtual void vtkImageColorViewer::UpdateOrientation ( ) [protected], [virtual]
```

#### 10.386.4.44 VTK\_LEGACY() [1/4]

```
vtkImageColorViewer::VTK_LEGACY (
    int GetWholeZMax() )
```

**10.386.4.45 VTK\_LEGACY() [2/4]**

```
vtkImageColorViewer::VTK_LEGACY (
    int  GetWholeZMin() )
```

**10.386.4.46 VTK\_LEGACY() [3/4]**

```
vtkImageColorViewer::VTK_LEGACY (
    int  GetZSlice() )
```

**10.386.4.47 VTK\_LEGACY() [4/4]**

```
vtkImageColorViewer::VTK_LEGACY (
    void  SetZSlice(int) )
```

**10.386.4.48 vtkBooleanMacro()**

```
vtkImageColorViewer::vtkBooleanMacro (
    OffScreenRendering ,
    int )
```

**10.386.4.49 vtkGetMacro() [1/2]**

```
vtkImageColorViewer::vtkGetMacro (
    Slice ,
    int )
```

**10.386.4.50 vtkGetMacro() [2/2]**

```
vtkImageColorViewer::vtkGetMacro (
    SliceOrientation ,
    int )
```

**10.386.4.51 vtkGetObjectMacro() [1/5]**

```
vtkImageColorViewer::vtkGetObjectMacro (
    ImageActor ,
    vtkImageActor )
```

**10.386.4.52 vtkGetObjectMacro() [2/5]**

```
vtkImageColorViewer::vtkGetObjectMacro (
    InteractorStyle ,
    vtkInteractorStyleImage )
```

**10.386.4.53 vtkGetObjectMacro() [3/5]**

```
vtkImageColorViewer::vtkGetObjectMacro (
    Renderer ,
    vtkRenderer )
```

**10.386.4.54 vtkGetObjectMacro() [4/5]**

```
vtkImageColorViewer::vtkGetObjectMacro (
    RenderWindow ,
    vtkRenderWindow )
```

**10.386.4.55 vtkGetObjectMacro() [5/5]**

```
vtkImageColorViewer::vtkGetObjectMacro (
    WindowLevel ,
    vtkImageMapToWindowLevelColors2 )
```

**10.386.4.56 vtkTypeMacro()**

```
vtkImageColorViewer::vtkTypeMacro (
    vtkImageColorViewer ,
    vtkObject )
```

## 10.386.5 Friends And Related Function Documentation

### 10.386.5.1 vtkImageColorViewerCallback

```
friend class vtkImageColorViewerCallback [friend]
```

## 10.386.6 Member Data Documentation

### 10.386.6.1 FirstRender

```
int vtkImageColorViewer::FirstRender [protected]
```

### 10.386.6.2 ImageActor

```
vtkImageActor* vtkImageColorViewer::ImageActor [protected]
```

### 10.386.6.3 Interactor

```
vtkRenderWindowInteractor* vtkImageColorViewer::Interactor [protected]
```

### 10.386.6.4 InteractorStyle

```
vtkInteractorStyleImage* vtkImageColorViewer::InteractorStyle [protected]
```

### 10.386.6.5 OverlayImageActor

```
vtkImageActor* vtkImageColorViewer::OverlayImageActor [protected]
```



### 10.386.6.6 Renderer

```
vtkRenderer* vtkImageColorViewer::Renderer [protected]
```

### 10.386.6.7 RenderWindow

```
vtkRenderWindow* vtkImageColorViewer::RenderWindow [protected]
```

### 10.386.6.8 Slice

```
int vtkImageColorViewer::Slice [protected]
```

### 10.386.6.9 SliceOrientation

```
int vtkImageColorViewer::SliceOrientation [protected]
```

### 10.386.6.10 WindowLevel

```
vtkImageMapToWindowLevelColors2* vtkImageColorViewer::WindowLevel [protected]
```

The documentation for this class was generated from the following file:

- [vtkImageColorViewer.h](#)

## 10.387 vtkImageMapToColors16 Class Reference

```
#include <vtkImageMapToColors16.h>
```

Inheritance diagram for vtkImageMapToColors16:

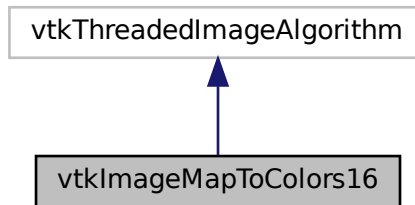

Collaboration diagram for vtkImageMapToColors16:

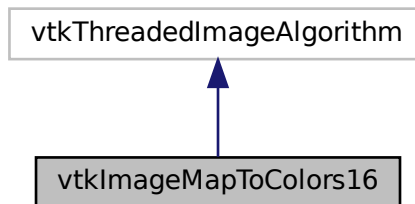

### Public Member Functions

- virtual unsigned long [GetMTime](#) ()
- void [PrintSelf](#) (ostream &os, vtkIndent indent)
- virtual void [SetLookupTable](#) (vtkScalarsToColors \*)
- void [SetOutputFormatToLuminance](#) ()
- void [SetOutputFormatToLuminanceAlpha](#) ()
- void [SetOutputFormatToRGB](#) ()
- void [SetOutputFormatToRGBA](#) ()
- [vtkBooleanMacro](#) ([PassAlphaToOutput](#), int)
- [vtkGetMacro](#) ([ActiveComponent](#), int)
- [vtkGetMacro](#) ([OutputFormat](#), int)

- [vtkGetMacro](#) ([PassAlphaToOutput](#), int)
- [vtkGetObjectMacro](#) ([LookupTable](#), [vtkScalarsToColors](#))
- [vtkSetMacro](#) ([ActiveComponent](#), int)
- [vtkSetMacro](#) ([OutputFormat](#), int)
- [vtkSetMacro](#) ([PassAlphaToOutput](#), int)
- [vtkTypeMacro](#) ([vtkImageMapToColors16](#), [vtkThreadedImageAlgorithm](#))

## Static Public Member Functions

- static [vtkImageMapToColors16](#) \* [New](#) ()

## Protected Member Functions

- [vtkImageMapToColors16](#) ()
- [~vtkImageMapToColors16](#) ()
- virtual int [RequestData](#) ([vtkInformation](#) \*request, [vtkInformationVector](#) \*\*inputVector, [vtkInformationVector](#) \*outputVector)
- virtual int [RequestInformation](#) ([vtkInformation](#) \*, [vtkInformationVector](#) \*\*, [vtkInformationVector](#) \*)
- void [ThreadedRequestData](#) ([vtkInformation](#) \*request, [vtkInformationVector](#) \*\*inputVector, [vtkInformationVector](#) \*outputVector, [vtkImageData](#) \*\*\*inData, [vtkImageData](#) \*\*outData, int extent[6], int id)

## Protected Attributes

- int [ActiveComponent](#)
- int [DataWasPassed](#)
- [vtkScalarsToColors](#) \* [LookupTable](#)
- int [OutputFormat](#)
- int [PassAlphaToOutput](#)

## 10.387.1 Constructor & Destructor Documentation

### 10.387.1.1 [vtkImageMapToColors16\(\)](#)

```
vtkImageMapToColors16::vtkImageMapToColors16 ( ) [protected]
```

### 10.387.1.2 [~vtkImageMapToColors16\(\)](#)

```
vtkImageMapToColors16::~~vtkImageMapToColors16 ( ) [protected]
```

## 10.387.2 Member Function Documentation

### 10.387.2.1 GetMTime()

```
virtual unsigned long vtkImageMapToColors16::GetMTime ( ) [virtual]
```

### 10.387.2.2 New()

```
static vtkImageMapToColors16* vtkImageMapToColors16::New ( ) [static]
```

### 10.387.2.3 PrintSelf()

```
void vtkImageMapToColors16::PrintSelf (
    ostream & os,
    vtkIndent indent )
```

### 10.387.2.4 RequestData()

```
virtual int vtkImageMapToColors16::RequestData (
    vtkInformation * request,
    vtkInformationVector ** inputVector,
    vtkInformationVector * outputVector ) [protected], [virtual]
```

### 10.387.2.5 RequestInformation()

```
virtual int vtkImageMapToColors16::RequestInformation (
    vtkInformation * ,
    vtkInformationVector ** ,
    vtkInformationVector * ) [protected], [virtual]
```

### 10.387.2.6 SetLookupTable()

```
virtual void vtkImageMapToColors16::SetLookupTable (
    vtkScalarsToColors * ) [virtual]
```

### 10.387.2.7 SetOutputFormatToLuminance()

```
void vtkImageMapToColors16::SetOutputFormatToLuminance ( ) [inline]
```

### 10.387.2.8 SetOutputFormatToLuminanceAlpha()

```
void vtkImageMapToColors16::SetOutputFormatToLuminanceAlpha ( ) [inline]
```

### 10.387.2.9 SetOutputFormatToRGB()

```
void vtkImageMapToColors16::SetOutputFormatToRGB ( ) [inline]
```

### 10.387.2.10 SetOutputFormatToRGBA()

```
void vtkImageMapToColors16::SetOutputFormatToRGBA ( ) [inline]
```

### 10.387.2.11 ThreadedRequestData()

```
void vtkImageMapToColors16::ThreadedRequestData (
    vtkInformation * request,
    vtkInformationVector ** inputVector,
    vtkInformationVector * outputVector,
    vtkImageData *** inData,
    vtkImageData ** outData,
    int extent[6],
    int id ) [protected]
```

**10.387.2.12 vtkBooleanMacro()**

```
vtkImageMapToColors16::vtkBooleanMacro (
    PassAlphaToOutput ,
    int )
```

**10.387.2.13 vtkGetMacro() [1/3]**

```
vtkImageMapToColors16::vtkGetMacro (
    ActiveComponent ,
    int )
```

**10.387.2.14 vtkGetMacro() [2/3]**

```
vtkImageMapToColors16::vtkGetMacro (
    OutputFormat ,
    int )
```

**10.387.2.15 vtkGetMacro() [3/3]**

```
vtkImageMapToColors16::vtkGetMacro (
    PassAlphaToOutput ,
    int )
```

**10.387.2.16 vtkGetObjectMacro()**

```
vtkImageMapToColors16::vtkGetObjectMacro (
    LookupTable ,
    vtkScalarsToColors )
```

**10.387.2.17 vtkSetMacro() [1/3]**

```
vtkImageMapToColors16::vtkSetMacro (
    ActiveComponent ,
    int )
```

**10.387.2.18 vtkSetMacro()** [2/3]

```
vtkImageMapToColors16::vtkSetMacro (
    OutputFormat ,
    int )
```

**10.387.2.19 vtkSetMacro()** [3/3]

```
vtkImageMapToColors16::vtkSetMacro (
    PassAlphaToOutput ,
    int )
```

**10.387.2.20 vtkTypeMacro()**

```
vtkImageMapToColors16::vtkTypeMacro (
    vtkImageMapToColors16 ,
    vtkThreadedImageAlgorithm )
```

**10.387.3 Member Data Documentation****10.387.3.1 ActiveComponent**

```
int vtkImageMapToColors16::ActiveComponent [protected]
```

**10.387.3.2 DataWasPassed**

```
int vtkImageMapToColors16::DataWasPassed [protected]
```

**10.387.3.3 LookupTable**

```
vtkScalarsToColors* vtkImageMapToColors16::LookupTable [protected]
```

### 10.387.3.4 OutputFormat

```
int vtkImageMapToColors16::OutputFormat [protected]
```

### 10.387.3.5 PassAlphaToOutput

```
int vtkImageMapToColors16::PassAlphaToOutput [protected]
```

The documentation for this class was generated from the following file:

- [vtkImageMapToColors16.h](#)

## 10.388 vtkImageMapToWindowLevelColors2 Class Reference

```
#include <vtkImageMapToWindowLevelColors2.h>
```

Inheritance diagram for vtkImageMapToWindowLevelColors2:

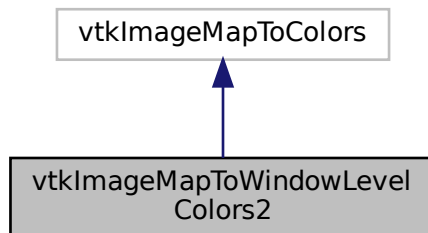

Collaboration diagram for vtkImageMapToWindowLevelColors2:

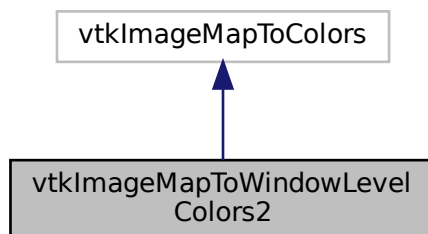



## Public Member Functions

- void [PrintSelf](#) (ostream &os, vtkIndent indent)
- [vtkGetMacro](#) ([Level](#), double)
- [vtkGetMacro](#) ([Window](#), double)
- [vtkSetMacro](#) ([Level](#), double)
- [vtkSetMacro](#) ([Window](#), double)
- [vtkTypeMacro](#) ([vtkImageMapToWindowLevelColors2](#), [vtkImageMapToColors](#))

## Static Public Member Functions

- static [vtkImageMapToWindowLevelColors2](#) \* [New](#) ()

## Protected Member Functions

- [vtkImageMapToWindowLevelColors2](#) ()
- [~vtkImageMapToWindowLevelColors2](#) ()
- virtual int [RequestData](#) (vtkInformation \*request, vtkInformationVector \*\*inputVector, vtkInformationVector \*outputVector)
- virtual int [RequestInformation](#) (vtkInformation \*, vtkInformationVector \*\*, vtkInformationVector \*)
- void [ThreadedRequestData](#) (vtkInformation \*request, vtkInformationVector \*\*inputVector, vtkInformationVector \*outputVector, vtkImageData \*\*\*inData, vtkImageData \*\*outData, int extent[6], int id)

## Protected Attributes

- double [Level](#)
- double [Window](#)

## 10.388.1 Constructor & Destructor Documentation

### 10.388.1.1 [vtkImageMapToWindowLevelColors2\(\)](#)

```
vtkImageMapToWindowLevelColors2::vtkImageMapToWindowLevelColors2 ( ) [protected]
```

### 10.388.1.2 [~vtkImageMapToWindowLevelColors2\(\)](#)

```
vtkImageMapToWindowLevelColors2::~~vtkImageMapToWindowLevelColors2 ( ) [protected]
```

## 10.388.2 Member Function Documentation

### 10.388.2.1 New()

```
static vtkImageMapToWindowLevelColors2* vtkImageMapToWindowLevelColors2::New ( ) [static]
```

### 10.388.2.2 PrintSelf()

```
void vtkImageMapToWindowLevelColors2::PrintSelf (
    ostream & os,
    vtkIndent indent )
```

### 10.388.2.3 RequestData()

```
virtual int vtkImageMapToWindowLevelColors2::RequestData (
    vtkInformation * request,
    vtkInformationVector ** inputVector,
    vtkInformationVector * outputVector ) [protected], [virtual]
```

### 10.388.2.4 RequestInformation()

```
virtual int vtkImageMapToWindowLevelColors2::RequestInformation (
    vtkInformation * ,
    vtkInformationVector ** ,
    vtkInformationVector * ) [protected], [virtual]
```

### 10.388.2.5 ThreadedRequestData()

```
void vtkImageMapToWindowLevelColors2::ThreadedRequestData (
    vtkInformation * request,
    vtkInformationVector ** inputVector,
    vtkInformationVector * outputVector,
    vtkImageData *** inData,
    vtkImageData ** outData,
    int extent[6],
    int id ) [protected]
```

### 10.388.2.6 vtkGetMacro() [1/2]

```
vtkImageMapToWindowLevelColors2::vtkGetMacro (
    Level ,
    double )
```

### 10.388.2.7 vtkGetMacro() [2/2]

```
vtkImageMapToWindowLevelColors2::vtkGetMacro (
    Window ,
    double )
```

### 10.388.2.8 vtkSetMacro() [1/2]

```
vtkImageMapToWindowLevelColors2::vtkSetMacro (
    Level ,
    double )
```

### 10.388.2.9 vtkSetMacro() [2/2]

```
vtkImageMapToWindowLevelColors2::vtkSetMacro (
    Window ,
    double )
```

### 10.388.2.10 vtkTypeMacro()

```
vtkImageMapToWindowLevelColors2::vtkTypeMacro (
    vtkImageMapToWindowLevelColors2 ,
    vtkImageMapToColors )
```

## 10.388.3 Member Data Documentation

### 10.388.3.1 Level

```
double vtkImageMapToWindowLevelColors2::Level [protected]
```

### 10.388.3.2 Window

```
double vtkImageMapToWindowLevelColors2::Window [protected]
```

The documentation for this class was generated from the following file:

- [vtkImageMapToWindowLevelColors2.h](#)

## 10.389 vtkImagePlanarComponentsToComponents Class Reference

```
#include <vtkImagePlanarComponentsToComponents.h>
```

Inheritance diagram for vtkImagePlanarComponentsToComponents:

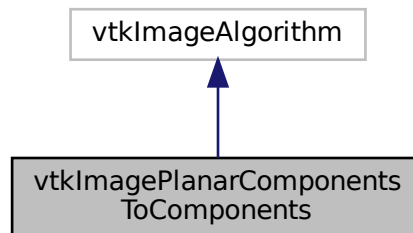

Collaboration diagram for vtkImagePlanarComponentsToComponents:

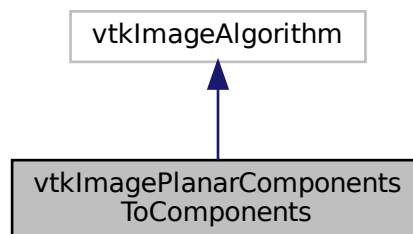

## Public Member Functions

- void [PrintSelf](#) (ostream &os, vtkIndent indent)
- [vtkTypeMacro](#) ([vtkImagePlanarComponentsToComponents](#), vtkImageAlgorithm)

## Static Public Member Functions

- static [vtkImagePlanarComponentsToComponents](#) \* [New](#) ()

## Protected Member Functions

- [vtkImagePlanarComponentsToComponents](#) ()
- [~vtkImagePlanarComponentsToComponents](#) ()
- virtual int [RequestData](#) (vtkInformation \*, vtkInformationVector \*\*, vtkInformationVector \*)

## 10.389.1 Constructor & Destructor Documentation

### 10.389.1.1 [vtkImagePlanarComponentsToComponents\(\)](#)

```
vtkImagePlanarComponentsToComponents::vtkImagePlanarComponentsToComponents ( ) [protected]
```

### 10.389.1.2 [~vtkImagePlanarComponentsToComponents\(\)](#)

```
vtkImagePlanarComponentsToComponents::~~vtkImagePlanarComponentsToComponents ( ) [inline], [protected]
```

## 10.389.2 Member Function Documentation

### 10.389.2.1 [New\(\)](#)

```
static vtkImagePlanarComponentsToComponents* vtkImagePlanarComponentsToComponents::New ( ) [static]
```

### 10.389.2.2 PrintSelf()

```
void vtkImagePlanarComponentsToComponents::PrintSelf (
    ostream & os,
    vtkIndent indent )
```

### 10.389.2.3 RequestData()

```
virtual int vtkImagePlanarComponentsToComponents::RequestData (
    vtkInformation * ,
    vtkInformationVector ** ,
    vtkInformationVector * ) [protected], [virtual]
```

### 10.389.2.4 vtkTypeMacro()

```
vtkImagePlanarComponentsToComponents::vtkTypeMacro (
    vtkImagePlanarComponentsToComponents ,
    vtkImageAlgorithm )
```

The documentation for this class was generated from the following file:

- [vtkImagePlanarComponentsToComponents.h](#)

## 10.390 vtkImageRGBToYBR Class Reference

```
#include <vtkImageRGBToYBR.h>
```

Inheritance diagram for vtkImageRGBToYBR:

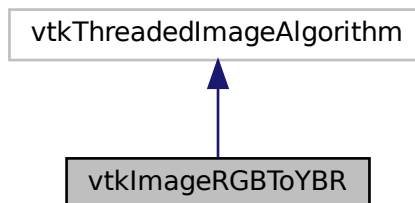

Collaboration diagram for vtkImageRGBToYBR:

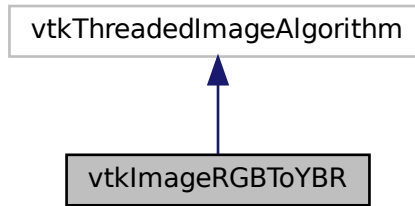

## Public Member Functions

- void [PrintSelf](#) (ostream &os, vtkIndent indent)
- [vtkTypeMacro](#) (vtkImageRGBToYBR, vtkThreadedImageAlgorithm)

## Static Public Member Functions

- static [vtkImageRGBToYBR \\* New](#) ()

## Protected Member Functions

- [vtkImageRGBToYBR](#) ()
- [~vtkImageRGBToYBR](#) ()
- void [ThreadedExecute](#) (vtkImageData \*inData, vtkImageData \*outData, int ext[6], int id)

### 10.390.1 Constructor & Destructor Documentation

#### 10.390.1.1 vtkImageRGBToYBR()

```
vtkImageRGBToYBR::vtkImageRGBToYBR ( ) [protected]
```

#### 10.390.1.2 ~vtkImageRGBToYBR()

```
vtkImageRGBToYBR::~~vtkImageRGBToYBR ( ) [inline], [protected]
```

## 10.390.2 Member Function Documentation

### 10.390.2.1 New()

```
static vtkImageRGBToYBR* vtkImageRGBToYBR::New ( ) [static]
```

### 10.390.2.2 PrintSelf()

```
void vtkImageRGBToYBR::PrintSelf (
    ostream & os,
    vtkIndent indent )
```

### 10.390.2.3 ThreadedExecute()

```
void vtkImageRGBToYBR::ThreadedExecute (
    vtkImageData * inData,
    vtkImageData * outData,
    int ext[6],
    int id ) [protected]
```

### 10.390.2.4 vtkTypeMacro()

```
vtkImageRGBToYBR::vtkTypeMacro (
    vtkImageRGBToYBR ,
    vtkThreadedImageAlgorithm )
```

The documentation for this class was generated from the following file:

- [vtkImageRGBToYBR.h](#)



## 10.391 vtkImageYBRToRGB Class Reference

```
#include <vtkImageYBRToRGB.h>
```

Inheritance diagram for vtkImageYBRToRGB:

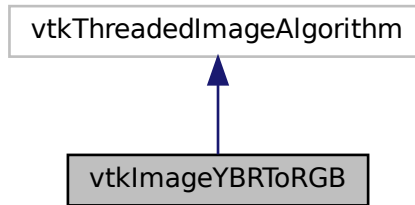

Collaboration diagram for vtkImageYBRToRGB:

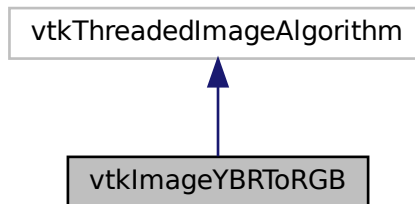

### Public Member Functions

- void `PrintSelf` (ostream &os, vtkIndent indent)
- `vtkTypeMacro` (`vtkImageYBRToRGB`, `vtkThreadedImageAlgorithm`)

### Static Public Member Functions

- static `vtkImageYBRToRGB * New` ()

## Protected Member Functions

- [vtkImageYBRToRGB](#) ()
- [~vtkImageYBRToRGB](#) ()
- void [ThreadedExecute](#) (vtkImageData \*inData, vtkImageData \*outData, int ext[6], int id)

### 10.391.1 Constructor & Destructor Documentation

#### 10.391.1.1 vtkImageYBRToRGB()

```
vtkImageYBRToRGB::vtkImageYBRToRGB ( ) [protected]
```

#### 10.391.1.2 ~vtkImageYBRToRGB()

```
vtkImageYBRToRGB::~~vtkImageYBRToRGB ( ) [inline], [protected]
```

### 10.391.2 Member Function Documentation

#### 10.391.2.1 New()

```
static vtkImageYBRToRGB\* vtkImageYBRToRGB::New ( ) [static]
```

#### 10.391.2.2 PrintSelf()

```
void vtkImageYBRToRGB::PrintSelf (
    ostream & os,
    vtkIndent indent )
```

### 10.391.2.3 ThreadedExecute()

```
void vtkImageYBRToRGB::ThreadedExecute (
    vtkImageData * inData,
    vtkImageData * outData,
    int ext[6],
    int id ) [protected]
```

### 10.391.2.4 vtkTypeMacro()

```
vtkImageYBRToRGB::vtkTypeMacro (
    vtkImageYBRToRGB ,
    vtkThreadedImageAlgorithm )
```

The documentation for this class was generated from the following file:

- [vtkImageYBRToRGB.h](#)

## 10.392 vtkLookupTable16 Class Reference

```
#include <vtkLookupTable16.h>
```

Inheritance diagram for vtkLookupTable16:

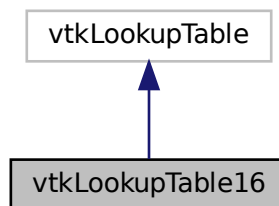

Collaboration diagram for vtkLookupTable16:

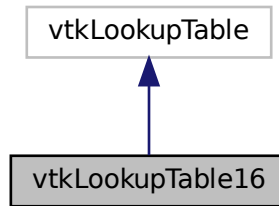

## Public Member Functions

- void [Build](#) ()
- unsigned short \* [GetPointer](#) (const vtkIdType id)
- void [PrintSelf](#) (ostream &os, vtkIndent indent)
- void [SetNumberOfTableValues](#) (vtkIdType number)
- [vtkTypeMacro](#) ([vtkLookupTable16](#), vtkLookupTable)
- unsigned char \* [WritePointer](#) (const vtkIdType id, const int number)

## Static Public Member Functions

- static [vtkLookupTable16](#) \* [New](#) ()

## Protected Member Functions

- [vtkLookupTable16](#) (int size=256, int ext=256)
- [~vtkLookupTable16](#) ()
- void [MapScalarsThroughTable2](#) (void \*input, unsigned char \*output, int inputDataType, int numberOfValues, int inputIncrement, int outputFormat)

## Protected Attributes

- vtkUnsignedShortArray \* [Table16](#)

## 10.392.1 Constructor & Destructor Documentation

### 10.392.1.1 vtkLookupTable16()

```
vtkLookupTable16::vtkLookupTable16 (
    int size = 256,
    int ext = 256 ) [protected]
```

### 10.392.1.2 ~vtkLookupTable16()

```
vtkLookupTable16::~vtkLookupTable16 ( ) [protected]
```

## 10.392.2 Member Function Documentation

### 10.392.2.1 Build()

```
void vtkLookupTable16::Build ( )
```

### 10.392.2.2 GetPointer()

```
unsigned short* vtkLookupTable16::GetPointer (
    const vtkIdType id ) [inline]
```

### 10.392.2.3 MapScalarsThroughTable2()

```
void vtkLookupTable16::MapScalarsThroughTable2 (
    void * input,
    unsigned char * output,
    int inputDataType,
    int numberOfValues,
    int inputIncrement,
    int outputFormat ) [protected]
```

#### 10.392.2.4 New()

```
static vtkLookupTable16* vtkLookupTable16::New ( ) [static]
```

#### 10.392.2.5 PrintSelf()

```
void vtkLookupTable16::PrintSelf (
    ostream & os,
    vtkIndent indent )
```

#### 10.392.2.6 SetNumberOfTableValues()

```
void vtkLookupTable16::SetNumberOfTableValues (
    vtkIdType number )
```

#### 10.392.2.7 vtkTypeMacro()

```
vtkLookupTable16::vtkTypeMacro (
    vtkLookupTable16 ,
    vtkLookupTable )
```

#### 10.392.2.8 WritePointer()

```
unsigned char * vtkLookupTable16::WritePointer (
    const vtkIdType id,
    const int number ) [inline]
```

References Table16.

### 10.392.3 Member Data Documentation

### 10.392.3.1 Table16

```
vtkUnsignedShortArray* vtkLookupTable16::Table16 [protected]
```

Referenced by WritePointer().

The documentation for this class was generated from the following file:

- [vtkLookupTable16.h](#)

## 10.393 vtkRTStructSetProperties Class Reference

```
#include <vtkRTStructSetProperties.h>
```

Inheritance diagram for vtkRTStructSetProperties:

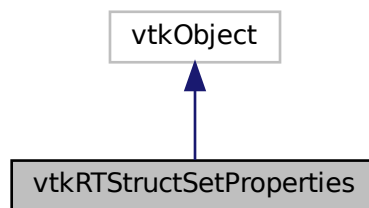

Collaboration diagram for vtkRTStructSetProperties:

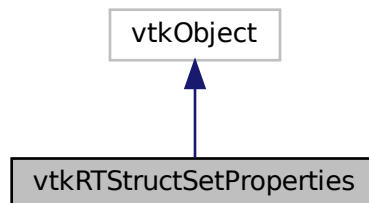

## Public Member Functions

- void [AddContourReferencedFrameOfReference](#) (vtkIdType pdnum, const char \*classuid, const char \*instanceuid)
- void [AddReferencedFrameOfReference](#) (const char \*classuid, const char \*instanceuid)
- void [AddStructureSetROI](#) (int roinumber, const char \*refframerefid, const char \*roiname, const char \*ROIGenerationAlgorithm, const char \*ROIDescription=0)
- void [AddStructureSetROIObservation](#) (int refnumber, int observationnumber, const char \*rtroiinterpretedtype, const char \*roiinterpreter, const char \*roiobservationlabel=0)
- virtual void [Clear](#) ()
- virtual void [DeepCopy](#) (vtkRTStructSetProperties \*p)
- const char \* [GetContourReferencedFrameOfReferenceClassUID](#) (vtkIdType pdnum, vtkIdType id)
- const char \* [GetContourReferencedFrameOfReferenceInstanceUID](#) (vtkIdType pdnum, vtkIdType id)
- vtkIdType [GetNumberOfContourReferencedFrameOfReferences](#) ()
- vtkIdType [GetNumberOfContourReferencedFrameOfReferences](#) (vtkIdType pdnum)
- vtkIdType [GetNumberOfReferencedFrameOfReferences](#) ()
- vtkIdType [GetNumberOfStructureSetROIs](#) ()
- const char \* [GetReferencedFrameOfReferenceClassUID](#) (vtkIdType id)
- const char \* [GetReferencedFrameOfReferenceInstanceUID](#) (vtkIdType id)
- int [GetStructureSetObservationNumber](#) (vtkIdType id)
- const char \* [GetStructureSetROIDescription](#) (vtkIdType id)
- const char \* [GetStructureSetROIGenerationAlgorithm](#) (vtkIdType)
- const char \* [GetStructureSetROIName](#) (vtkIdType)
- int [GetStructureSetROINumber](#) (vtkIdType id)
- const char \* [GetStructureSetROIObservationLabel](#) (vtkIdType id)
- const char \* [GetStructureSetROIRefFrameRefUID](#) (vtkIdType)
- const char \* [GetStructureSetRTROIInterpretedType](#) (vtkIdType id)
- void [PrintSelf](#) (ostream &os, vtkIndent indent)
- [vtkGetStringMacro](#) (ReferenceFrameOfReferenceUID)
- [vtkGetStringMacro](#) (ReferenceSeriesInstanceUID)
- [vtkGetStringMacro](#) (SeriesInstanceUID)
- [vtkGetStringMacro](#) (SOPInstanceUID)
- [vtkGetStringMacro](#) (StructureSetDate)
- [vtkGetStringMacro](#) (StructureSetLabel)
- [vtkGetStringMacro](#) (StructureSetName)
- [vtkGetStringMacro](#) (StructureSetTime)
- [vtkGetStringMacro](#) (StudyInstanceUID)
- [vtkSetStringMacro](#) (ReferenceFrameOfReferenceUID)
- [vtkSetStringMacro](#) (ReferenceSeriesInstanceUID)
- [vtkSetStringMacro](#) (SeriesInstanceUID)
- [vtkSetStringMacro](#) (SOPInstanceUID)
- [vtkSetStringMacro](#) (StructureSetDate)
- [vtkSetStringMacro](#) (StructureSetLabel)
- [vtkSetStringMacro](#) (StructureSetName)
- [vtkSetStringMacro](#) (StructureSetTime)
- [vtkSetStringMacro](#) (StudyInstanceUID)
- [vtkTypeMacro](#) (vtkRTStructSetProperties, vtkObject)

## Static Public Member Functions

- static [vtkRTStructSetProperties](#) \* [New](#) ()



## Protected Member Functions

- [vtkRTStructSetProperties \(\)](#)
- [~vtkRTStructSetProperties \(\)](#)

## Protected Attributes

- vtkRTStructSetPropertiesInternals \* [Internals](#)
- char \* [ReferenceFrameOfReferenceUID](#)
- char \* [ReferenceSeriesInstanceUID](#)
- char \* [SeriesInstanceUID](#)
- char \* [SOPInstanceUID](#)
- char \* [StructureSetDate](#)
- char \* [StructureSetLabel](#)
- char \* [StructureSetName](#)
- char \* [StructureSetTime](#)
- char \* [StudyInstanceUID](#)

### 10.393.1 Detailed Description

Examples

[GenerateRTSTRUCT.cxx](#).

### 10.393.2 Constructor & Destructor Documentation

#### 10.393.2.1 vtkRTStructSetProperties()

```
vtkRTStructSetProperties::vtkRTStructSetProperties ( ) [protected]
```

#### 10.393.2.2 ~vtkRTStructSetProperties()

```
vtkRTStructSetProperties::~~vtkRTStructSetProperties ( ) [protected]
```

### 10.393.3 Member Function Documentation

### 10.393.3.1 AddContourReferencedFrameOfReference()

```
void vtkRTStructSetProperties::AddContourReferencedFrameOfReference (
    vtkIdType pdnum,
    const char * classuid,
    const char * instanceuid )
```

### 10.393.3.2 AddReferencedFrameOfReference()

```
void vtkRTStructSetProperties::AddReferencedFrameOfReference (
    const char * classuid,
    const char * instanceuid )
```

### 10.393.3.3 AddStructureSetROI()

```
void vtkRTStructSetProperties::AddStructureSetROI (
    int roinumber,
    const char * refframerefuid,
    const char * roiname,
    const char * ROIGenerationAlgorithm,
    const char * ROIDescription = 0 )
```

### 10.393.3.4 AddStructureSetROIObservation()

```
void vtkRTStructSetProperties::AddStructureSetROIObservation (
    int refnumber,
    int observationnumber,
    const char * rroiinterpretedtype,
    const char * roiinterpreter,
    const char * roiobservationlabel = 0 )
```

### 10.393.3.5 Clear()

```
virtual void vtkRTStructSetProperties::Clear ( ) [virtual]
```

### 10.393.3.6 DeepCopy()

```
virtual void vtkRTStructSetProperties::DeepCopy (
    vtkRTStructSetProperties * p ) [virtual]
```

### 10.393.3.7 GetContourReferencedFrameOfReferenceClassUID()

```
const char* vtkRTStructSetProperties::GetContourReferencedFrameOfReferenceClassUID (
    vtkIdType pdnum,
    vtkIdType id )
```

### 10.393.3.8 GetContourReferencedFrameOfReferenceInstanceUID()

```
const char* vtkRTStructSetProperties::GetContourReferencedFrameOfReferenceInstanceUID (
    vtkIdType pdnum,
    vtkIdType id )
```

### 10.393.3.9 GetNumberOfContourReferencedFrameOfReferences() [1/2]

```
vtkIdType vtkRTStructSetProperties::GetNumberOfContourReferencedFrameOfReferences ( )
```

### 10.393.3.10 GetNumberOfContourReferencedFrameOfReferences() [2/2]

```
vtkIdType vtkRTStructSetProperties::GetNumberOfContourReferencedFrameOfReferences (
    vtkIdType pdnum )
```

### 10.393.3.11 GetNumberOfReferencedFrameOfReferences()

```
vtkIdType vtkRTStructSetProperties::GetNumberOfReferencedFrameOfReferences ( )
```

**10.393.3.12 GetNumberOfStructureSetROIs()**

```
vtkIdType vtkRTStructSetProperties::GetNumberOfStructureSetROIs ( )
```

**10.393.3.13 GetReferencedFrameOfReferenceClassUID()**

```
const char* vtkRTStructSetProperties::GetReferencedFrameOfReferenceClassUID (
    vtkIdType id )
```

**10.393.3.14 GetReferencedFrameOfReferenceInstanceUID()**

```
const char* vtkRTStructSetProperties::GetReferencedFrameOfReferenceInstanceUID (
    vtkIdType id )
```

**10.393.3.15 GetStructureSetObservationNumber()**

```
int vtkRTStructSetProperties::GetStructureSetObservationNumber (
    vtkIdType id )
```

**10.393.3.16 GetStructureSetROIDescription()**

```
const char* vtkRTStructSetProperties::GetStructureSetROIDescription (
    vtkIdType id )
```

**10.393.3.17 GetStructureSetROIGenerationAlgorithm()**

```
const char* vtkRTStructSetProperties::GetStructureSetROIGenerationAlgorithm (
    vtkIdType id )
```

### 10.393.3.18 GetStructureSetROIName()

```
const char* vtkRTStructSetProperties::GetStructureSetROIName (
    vtkIdType )
```

### 10.393.3.19 GetStructureSetROINumber()

```
int vtkRTStructSetProperties::GetStructureSetROINumber (
    vtkIdType id )
```

### 10.393.3.20 GetStructureSetROIObservationLabel()

```
const char* vtkRTStructSetProperties::GetStructureSetROIObservationLabel (
    vtkIdType id )
```

### 10.393.3.21 GetStructureSetROIRefFrameRefUID()

```
const char* vtkRTStructSetProperties::GetStructureSetROIRefFrameRefUID (
    vtkIdType )
```

### 10.393.3.22 GetStructureSetRTROIInterpretedType()

```
const char* vtkRTStructSetProperties::GetStructureSetRTROIInterpretedType (
    vtkIdType id )
```

### 10.393.3.23 New()

```
static vtkRTStructSetProperties\* vtkRTStructSetProperties::New ( ) [static]
```

#### Examples

[GenerateRTSTRUCT.cxx](#).

**10.393.3.24 PrintSelf()**

```
void vtkRTStructSetProperties::PrintSelf (
    ostream & os,
    vtkIndent indent )
```

**10.393.3.25 vtkGetStringMacro() [1/9]**

```
vtkRTStructSetProperties::vtkGetStringMacro (
    ReferenceFrameOfReferenceUID )
```

**10.393.3.26 vtkGetStringMacro() [2/9]**

```
vtkRTStructSetProperties::vtkGetStringMacro (
    ReferenceSeriesInstanceUID )
```

**10.393.3.27 vtkGetStringMacro() [3/9]**

```
vtkRTStructSetProperties::vtkGetStringMacro (
    SeriesInstanceUID )
```

**10.393.3.28 vtkGetStringMacro() [4/9]**

```
vtkRTStructSetProperties::vtkGetStringMacro (
    SOPInstanceUID )
```

**10.393.3.29 vtkGetStringMacro() [5/9]**

```
vtkRTStructSetProperties::vtkGetStringMacro (
    StructureSetDate )
```

**10.393.3.30 vtkGetStringMacro()** [6/9]

```
vtkRTStructSetProperties::vtkGetStringMacro (
    StructureSetLabel )
```

**10.393.3.31 vtkGetStringMacro()** [7/9]

```
vtkRTStructSetProperties::vtkGetStringMacro (
    StructureSetName )
```

**10.393.3.32 vtkGetStringMacro()** [8/9]

```
vtkRTStructSetProperties::vtkGetStringMacro (
    StructureSetTime )
```

**10.393.3.33 vtkGetStringMacro()** [9/9]

```
vtkRTStructSetProperties::vtkGetStringMacro (
    StudyInstanceUID )
```

**10.393.3.34 vtkSetStringMacro()** [1/9]

```
vtkRTStructSetProperties::vtkSetStringMacro (
    ReferenceFrameOfReferenceUID )
```

**10.393.3.35 vtkSetStringMacro()** [2/9]

```
vtkRTStructSetProperties::vtkSetStringMacro (
    ReferenceSeriesInstanceUID )
```

**10.393.3.36 vtkSetStringMacro()** [3/9]

```
vtkRTStructSetProperties::vtkSetStringMacro (
    SeriesInstanceUID )
```

**10.393.3.37 vtkSetStringMacro()** [4/9]

```
vtkRTStructSetProperties::vtkSetStringMacro (
    SOPInstanceUID )
```

**10.393.3.38 vtkSetStringMacro()** [5/9]

```
vtkRTStructSetProperties::vtkSetStringMacro (
    StructureSetDate )
```

**10.393.3.39 vtkSetStringMacro()** [6/9]

```
vtkRTStructSetProperties::vtkSetStringMacro (
    StructureSetLabel )
```

**10.393.3.40 vtkSetStringMacro()** [7/9]

```
vtkRTStructSetProperties::vtkSetStringMacro (
    StructureSetName )
```

**10.393.3.41 vtkSetStringMacro()** [8/9]

```
vtkRTStructSetProperties::vtkSetStringMacro (
    StructureSetTime )
```



### 10.393.3.42 vtkSetStringMacro() [9/9]

```
vtkRTStructSetProperties::vtkSetStringMacro (
    StudyInstanceUID )
```

### 10.393.3.43 vtkTypeMacro()

```
vtkRTStructSetProperties::vtkTypeMacro (
    vtkRTStructSetProperties ,
    vtkObject )
```

## 10.393.4 Member Data Documentation

### 10.393.4.1 Internals

```
vtkRTStructSetPropertiesInternals* vtkRTStructSetProperties::Internals [protected]
```

### 10.393.4.2 ReferenceFrameOfReferenceUID

```
char* vtkRTStructSetProperties::ReferenceFrameOfReferenceUID [protected]
```

### 10.393.4.3 ReferenceSeriesInstanceUID

```
char* vtkRTStructSetProperties::ReferenceSeriesInstanceUID [protected]
```

### 10.393.4.4 SeriesInstanceUID

```
char* vtkRTStructSetProperties::SeriesInstanceUID [protected]
```

#### 10.393.4.5 SOPInstanceUID

```
char* vtkRTStructSetProperties::SOPInstanceUID [protected]
```

#### 10.393.4.6 StructureSetDate

```
char* vtkRTStructSetProperties::StructureSetDate [protected]
```

#### 10.393.4.7 StructureSetLabel

```
char* vtkRTStructSetProperties::StructureSetLabel [protected]
```

#### 10.393.4.8 StructureSetName

```
char* vtkRTStructSetProperties::StructureSetName [protected]
```

#### 10.393.4.9 StructureSetTime

```
char* vtkRTStructSetProperties::StructureSetTime [protected]
```

#### 10.393.4.10 StudyInstanceUID

```
char* vtkRTStructSetProperties::StudyInstanceUID [protected]
```

The documentation for this class was generated from the following file:

- [vtkRTStructSetProperties.h](#)

## 10.394 gdcm::Waveform Class Reference

[Waveform](#) class.

```
#include <gdcmWaveform.h>
```

## Public Member Functions

- [Waveform](#) ()=default

### 10.394.1 Detailed Description

[Waveform](#) class.

### 10.394.2 Constructor & Destructor Documentation

#### 10.394.2.1 Waveform()

```
gdcM::Waveform::Waveform ( ) [default]
```

The documentation for this class was generated from the following file:

- [gdcMWaveform.h](#)

## 10.395 gdcM::WLMFindQuery Class Reference

PatientRootQuery.

```
#include <gdcMWLMFindQuery.h>
```

Inheritance diagram for gdcM::WLMFindQuery:

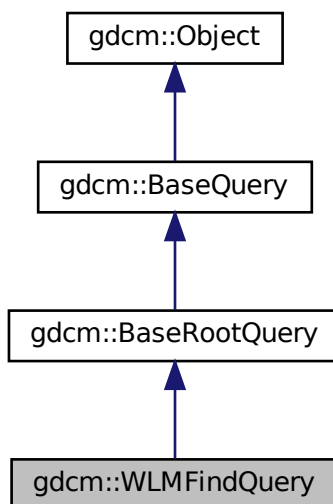

Collaboration diagram for `gdcm::WLMFindQuery`:

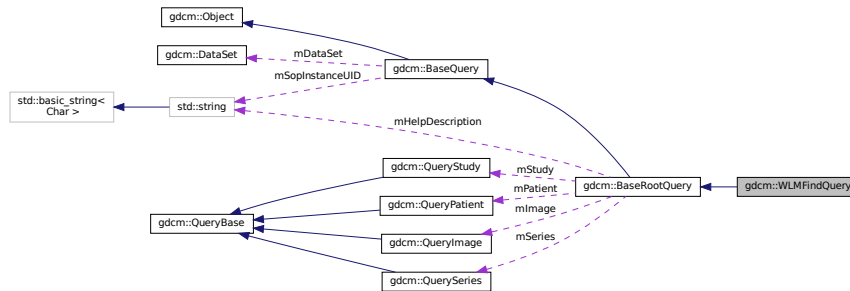

## Public Member Functions

- [WLMFindQuery \(\)](#)
- [UIDs::TSName GetAbstractSyntaxUID \(\)](#) const override
- [std::vector< Tag > GetTagListByLevel \(const EQueryLevel &inQueryLevel\)](#) override
- [void InitializeDataSet \(const EQueryLevel &inQueryLevel\)](#) override
- [bool ValidateQuery \(bool inStrict=true\)](#) const override

## Protected Member Functions

- [DataSet GetValidDataSet \(\)](#) const

## Friends

- class [QueryFactory](#)

## Additional Inherited Members

### 10.395.1 Detailed Description

PatientRootQuery.

contains: the class which will produce a dataset for c-find with patient root

### 10.395.2 Constructor & Destructor Documentation

### 10.395.2.1 WLMFindQuery()

```
gdcm::WLMFindQuery::WLMFindQuery ( )
```

## 10.395.3 Member Function Documentation

### 10.395.3.1 GetAbstractSyntaxUID()

```
UIDs::TSName gdcm::WLMFindQuery::GetAbstractSyntaxUID ( ) const [override], [virtual]
```

Implements [gdcm::BaseQuery](#).

### 10.395.3.2 GetTagListByLevel()

```
std::vector<Tag> gdcm::WLMFindQuery::GetTagListByLevel (
    const EQueryLevel & inQueryLevel ) [override], [virtual]
```

this function will return all tags at a given query level, so that they maybe selected for searching. The boolean forFind is true if the query is a find query, or false for a move query.

Implements [gdcm::BaseRootQuery](#).

### 10.395.3.3 GetValidDataSet()

```
DataSet gdcm::WLMFindQuery::GetValidDataSet ( ) const [protected]
```

### 10.395.3.4 InitializeDataSet()

```
void gdcm::WLMFindQuery::InitializeDataSet (
    const EQueryLevel & inQueryLevel ) [override], [virtual]
```

this function sets tag 8,52 to the appropriate value based on query level also fills in the right unique tags, as per the standard's requirements should allow for connection with dcmTk

Implements [gdcm::BaseRootQuery](#).

### 10.395.3.5 ValidateQuery()

```
bool gdcM::WLMFindQuery::ValidateQuery (
    bool inStrict = true ) const [override], [virtual]
```

have to be able to ensure that 0x8,0x52 is set (which will be true if InitializeDataSet is called...) that the level is appropriate (ie, not setting PATIENT for a study query that the tags in the query match the right level (either required, unique, optional) by default, this function checks to see if the query is for finding, which is more permissive than for moving. For moving, only the unique tags are allowed. 10 Jan 2011: adding in the 'strict' mode. according to the standard (at least, how I've read it), only tags for a particular level should be allowed in a particular query (ie, just series level tags in a series level query). However, it seems that dcm4chee doesn't share that interpretation. So, if 'inStrict' is false, then tags from the current level and all higher levels are now considered valid. So, if you're doing a non-strict series-level query, tags from the patient and study level can be passed along as well.

Implements [gdcM::BaseRootQuery](#).

## 10.395.4 Friends And Related Function Documentation

### 10.395.4.1 QueryFactory

```
friend class QueryFactory [friend]
```

The documentation for this class was generated from the following file:

- [gdcM\\_WLMFindQuery.h](#)

## 10.396 gdcM::Writer Class Reference

[Writer](#) ala DOM (Document [Object](#) Model)

```
#include <gdcMWriter.h>
```

Inheritance diagram for gdcM::Writer:

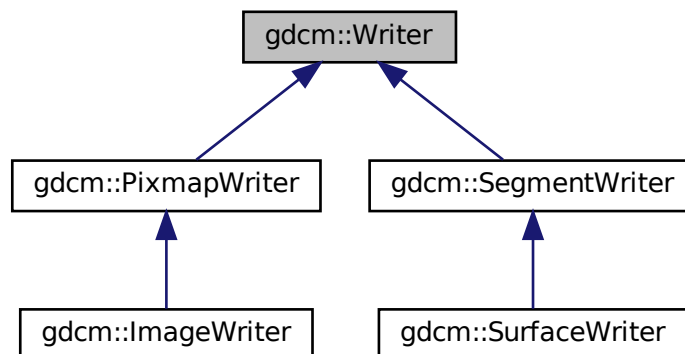

Collaboration diagram for gdcm::Writer:

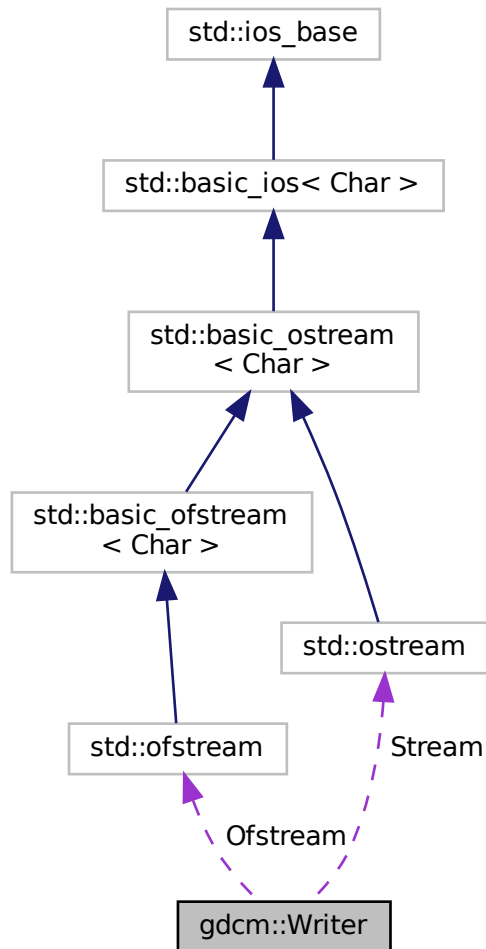

## Public Member Functions

- [Writer](#) ()
- virtual [~Writer](#) ()
- void [CheckFileMetaInformationOff](#) ()
- void [CheckFileMetaInformationOn](#) ()
- [File](#) & [GetFile](#) ()
- void [SetCheckFileMetaInformation](#) (bool b)  
*Undocumented function, do not use (= leave default)*
- void [SetFile](#) (const [File](#) &f)  
*Set/Get the DICOM file ([DataSet](#) + Header)*

- void [SetFileName](#) (const char \*filename\_native)  
*Set the filename of DICOM file to write.*
- void [SetStream](#) (std::ostream &output\_stream)  
*Set user ostream buffer.*
- virtual bool [Write](#) ()  
*Main function to tell the writer to write.*

## Protected Member Functions

- bool [GetCheckFileMetaInformation](#) () const
- std::ostream \* [GetStreamPtr](#) () const
- void [SetWriteDataSetOnly](#) (bool b)

## Protected Attributes

- std::ofstream \* [Ofstream](#)
- std::ostream \* [Stream](#)

## Friends

- class [StreamImageWriter](#)

## 10.396.1 Detailed Description

[Writer](#) ala DOM (Document [Object](#) Model)

This class is a non-validating writer, it will only performs well- formedness check only.

Detailed description here To avoid GDCM being yet another broken DICOM lib we try to be user level and avoid writing illegal stuff (odd length, non-zero value for [Item](#) start/end length ...) Therefore you cannot (well unless you are really smart) write DICOM with even length tag. All the checks are consider basics:

- Correct Meta Information Header (see [gdcm::FileMetaInformation](#))
- Zero value for [Item](#) Length (0xfffe, 0xe00d/0xe0dd)
- Even length for any elements
- Alphabetical order for elements (guaranteed by design of internals)
- 32bits [VR](#) will be rewritten with 00

### Warning

[gdcm::Writer](#) cannot write a [DataSet](#) if no SOP Instance UID (0008,0018) is found, unless a [DICOMDIR](#) is being written out

### See also

[Reader DataSet File](#)

### Examples

[ChangePrivateTags.cxx](#), [ChangeSequenceUltrasound.cxx](#), [ClinicalTrialAnnotate.cxx](#), [CreateFakeRTDOSE.cxx](#), [CreateJPIPDataSet.cxx](#), [DeriveSeries.cxx](#), [DuplicatePCDE.cxx](#), [EncapsulateFileInRawData.cxx](#), [Extracting\\_All\\_Resolution.cxx](#), [Fake\\_Image\\_Using\\_Stream\\_Image\\_Writer.cxx](#), [FixBrokenJ2K.cxx](#), [FixJAIBugJPEGLS.cxx](#), [FixOrientation.cxx](#), [GenAllVR.cxx](#), [GenFakelIdentifyFile.cxx](#), [GenLongSeqs.cxx](#), [GenSeqs.cxx](#), [HelloWorld.cxx](#), [LargeVRDSExplicit.cxx](#), [MakeTemplate.cxx](#), [PatchFile.cxx](#), [QIDO-RS.cxx](#), [StreamImageReaderTest.cxx](#), [pmsct\\_rgb1.cxx](#), and [rle2img.cxx](#).



## 10.396.2 Constructor & Destructor Documentation

### 10.396.2.1 Writer()

```
gdcM::Writer::Writer ( )
```

### 10.396.2.2 ~Writer()

```
virtual gdcM::Writer::~Writer ( ) [virtual]
```

## 10.396.3 Member Function Documentation

### 10.396.3.1 CheckFileMetaInformationOff()

```
void gdcM::Writer::CheckFileMetaInformationOff ( ) [inline]
```

#### Examples

[CreateFakeRTDOSE.cxx](#), [FixBrokenJ2K.cxx](#), and [HelloWorld.cxx](#).

### 10.396.3.2 CheckFileMetaInformationOn()

```
void gdcM::Writer::CheckFileMetaInformationOn ( ) [inline]
```

### 10.396.3.3 GetCheckFileMetaInformation()

```
bool gdcM::Writer::GetCheckFileMetaInformation ( ) const [inline], [protected]
```

### 10.396.3.4 GetFile()

```
File& gdcM::Writer::GetFile ( ) [inline]
```

#### Examples

[CreateJPIPDataSet.cxx](#), [EncapsulateFileInRawData.cxx](#), [Extracting\\_All\\_Resolution.cxx](#), [Fake\\_Image\\_Using\\_Stream\\_Image\\_Writer.cxx](#), [GenAllVR.cxx](#), [GenFakeIdentifyFile.cxx](#), [GetSubSequenceData.cxx](#), [QIDO-RS.cxx](#), [StreamImageReaderTest.cxx](#), [TemplateEmptyImage.cxx](#), [iU22tomultisc.cxx](#), [pmsct\\_rgb1.cxx](#), and [rle2img.cxx](#).

### 10.396.3.5 GetStreamPtr()

```
std::ostream* gdcM::Writer::GetStreamPtr ( ) const [inline], [protected]
```

### 10.396.3.6 SetCheckFileMetaInformation()

```
void gdcM::Writer::SetCheckFileMetaInformation (
    bool b ) [inline]
```

Undocumented function, do not use (= leave default)

#### Examples

[GenAllVR.cxx](#), [GenFakeIdentifyFile.cxx](#), and [PatchFile.cxx](#).

### 10.396.3.7 SetFile()

```
void gdcM::Writer::SetFile (
    const File & f ) [inline]
```

Set/Get the DICOM file ([DataSet](#) + Header)

#### Examples

[ChangePrivateTags.cxx](#), [ChangeSequenceUltrasound.cxx](#), [ClinicalTrialAnnotate.cxx](#), [CompressImage.cxx](#), [CreateFakeRTDOSE.cxx](#), [DeriveSeries.cxx](#), [DuplicatePCDE.cxx](#), [FixBrokenJ2K.cxx](#), [FixJAIBugJPEGLS.cxx](#), [FixOrientation.cxx](#), [GenFakeImage.cxx](#), [GenLongSeqs.cxx](#), [GenSeqs.cxx](#), [HelloWorld.cxx](#), [LargeVRDSExplicit.cxx](#), [MakeTemplate.cxx](#), [MergeTwoFiles.cxx](#), [NewSequence.cs](#), [PatchFile.cxx](#), [pmsct\\_rgb1.cxx](#), and [rle2img.cxx](#).

### 10.396.3.8 SetFileName()

```
void gdcm::Writer::SetFileName (
    const char * filename_native )
```

Set the filename of DICOM file to write:

#### Examples

[ChangePrivateTags.cxx](#), [ChangeSequenceUltrasound.cxx](#), [ClinicalTrialAnnotate.cxx](#), [CompressImage.cxx](#), [CreateARGBImage.cxx](#), [CreateCMYKImage.cxx](#), [CreateFakeRTDOSE.cxx](#), [CreateJPIPDataSet.cxx](#), [DeriveSeries.cxx](#), [DuplicatePCDE.cxx](#), [EncapsulateFileInRawData.cxx](#), [FixBrokenJ2K.cxx](#), [FixJAIBugJPEGLS.cxx](#), [FixOrientation.cxx](#), [GenAllVR.cxx](#), [GenFakeIdentifyFile.cxx](#), [GenFakeImage.cxx](#), [GenLongSeqs.cxx](#), [GenSeqs.cxx](#), [GetSubSequenceData.cxx](#), [HelloVizWorld.cxx](#), [HelloWorld.cxx](#), [LargeVRDSExplicit.cxx](#), [MakeTemplate.cxx](#), [MergeTwoFiles.cxx](#), [PatchFile.cxx](#), [QIDO-RS.cxx](#), [TemplateEmptyImage.cxx](#), [csa2img.cxx](#), [iU22tomultisc.cxx](#), [pmsct\\_rgb1.cxx](#), and [rle2img.cxx](#).

### 10.396.3.9 SetStream()

```
void gdcm::Writer::SetStream (
    std::ostream & output_stream ) [inline]
```

Set user ostream buffer.

### 10.396.3.10 SetWriteDataSetOnly()

```
void gdcm::Writer::SetWriteDataSetOnly (
    bool b ) [inline], [protected]
```

### 10.396.3.11 Write()

```
virtual bool gdcm::Writer::Write ( ) [virtual]
```

Main function to tell the writer to write.

Reimplemented in [gdcm::SurfaceWriter](#), [gdcm::SegmentWriter](#), [gdcm::PixmapWriter](#), and [gdcm::ImageWriter](#).

#### Examples

[ChangePrivateTags.cxx](#), [ChangeSequenceUltrasound.cxx](#), [ClinicalTrialAnnotate.cxx](#), [CreateFakeRTDOSE.cxx](#), [CreateJPIPDataSet.cxx](#), [DeriveSeries.cxx](#), [DuplicatePCDE.cxx](#), [EncapsulateFileInRawData.cxx](#), [FixBrokenJ2K.cxx](#), [FixJAIBugJPEGLS.cxx](#), [FixOrientation.cxx](#), [GenAllVR.cxx](#), [GenFakeIdentifyFile.cxx](#), [GenLongSeqs.cxx](#), [GenSeqs.cxx](#), [HelloWorld.cxx](#), [LargeVRDSExplicit.cxx](#), [MakeTemplate.cxx](#), [PatchFile.cxx](#), [QIDO-RS.cxx](#), [pmsct\\_rgb1.cxx](#), and [rle2img.cxx](#).

## 10.396.4 Friends And Related Function Documentation

### 10.396.4.1 StreamImageWriter

```
friend class StreamImageWriter [friend]
```

## 10.396.5 Member Data Documentation

### 10.396.5.1 Ofstream

```
std::ofstream* gdcM::Writer::Ofstream [protected]
```

### 10.396.5.2 Stream

```
std::ostream* gdcM::Writer::Stream [protected]
```

The documentation for this class was generated from the following file:

- [gdcMWriter.h](#)

## 10.397 [gdcM::XMLDictReader](#) Class Reference

Class for representing a [XMLDictReader](#).

```
#include <gdcMXMLDictReader.h>
```

Inheritance diagram for [gdcM::XMLDictReader](#):

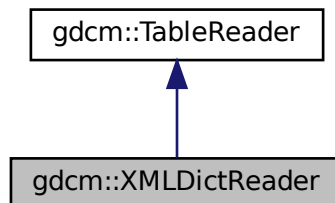

Collaboration diagram for gdcm::XMLDictReader:

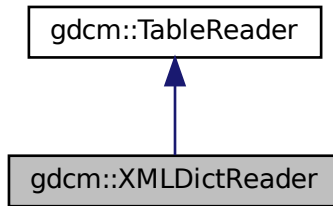

## Public Member Functions

- [XMLDictReader](#) ()
- [~XMLDictReader](#) ()
- void [CharacterDataHandler](#) (const char \*data, int length)
- void [EndElement](#) (const char \*name)
- const [Dict](#) & [GetDict](#) ()
- void [StartElement](#) (const char \*name, const char \*\*atts)

## Protected Member Functions

- void [HandleDescription](#) (const char \*\*atts)
- void [HandleEntry](#) (const char \*\*atts)

### 10.397.1 Detailed Description

Class for representing a [XMLDictReader](#).

#### Note

bla Will read the DICOMV3.xml file

### 10.397.2 Constructor & Destructor Documentation

#### 10.397.2.1 XMLDictReader()

```
gdcm::XMLDictReader::XMLDictReader ( )
```

### 10.397.2.2 ~XMLDictReader()

```
gdcM::XMLDictReader::~~XMLDictReader ( ) [inline]
```

## 10.397.3 Member Function Documentation

### 10.397.3.1 CharacterDataHandler()

```
void gdcM::XMLDictReader::CharacterDataHandler (
    const char * data,
    int length ) [virtual]
```

Reimplemented from [gdcM::TableReader](#).

### 10.397.3.2 EndElement()

```
void gdcM::XMLDictReader::EndElement (
    const char * name ) [virtual]
```

Reimplemented from [gdcM::TableReader](#).

### 10.397.3.3 GetDict()

```
const Dict& gdcM::XMLDictReader::GetDict ( ) [inline]
```

### 10.397.3.4 HandleDescription()

```
void gdcM::XMLDictReader::HandleDescription (
    const char ** atts ) [protected]
```

### 10.397.3.5 HandleEntry()

```
void gdcm::XMLDictReader::HandleEntry (
    const char ** atts ) [protected]
```

### 10.397.3.6 StartElement()

```
void gdcm::XMLDictReader::StartElement (
    const char * name,
    const char ** atts ) [virtual]
```

Reimplemented from [gdcm::TableReader](#).

The documentation for this class was generated from the following file:

- [gdcmXMLDictReader.h](#)

## 10.398 gdcm::XMLPrinter Class Reference

```
#include <gdcmXMLPrinter.h>
```

Collaboration diagram for gdcm::XMLPrinter:

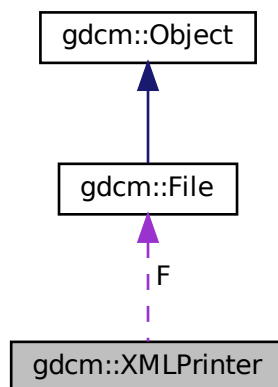

## Public Types

- enum [PrintStyles](#) {  
[OnlyUUID](#) = 0 ,  
[LOADBULKDATA](#) = 1 }

## Public Member Functions

- [XMLPrinter](#) ()
- virtual [~XMLPrinter](#) ()
- [PrintStyles GetPrintStyle](#) () const
- virtual void [HandleBulkData](#) (const char \*uuid, const [TransferSyntax](#) &ts, const char \*bulkdata, size\_t bulklen)
- void [Print](#) (std::ostream &os)
- void [PrintDataSet](#) (const [DataSet](#) &ds, const [TransferSyntax](#) &ts, std::ostream &os)
- void [SetFile](#) ([File](#) const &f)
- void [SetStyle](#) ([PrintStyles](#) ps)

## Protected Member Functions

- [VR PrintDataElement](#) (std::ostream &os, const [Dicts](#) &dicts, const [DataSet](#) &ds, const [DataElement](#) &de, const [TransferSyntax](#) &ts)
- void [PrintSQ](#) (const [SequenceOfItems](#) \*sqi, const [TransferSyntax](#) &ts, std::ostream &os)

## Protected Attributes

- const [File](#) \* F
- [PrintStyles](#) [PrintStyle](#)

## 10.398.1 Member Enumeration Documentation

### 10.398.1.1 PrintStyles

```
enum gdcm::XMLPrinter::PrintStyles
```

Enumerator

OnlyUUID	
LOADBULKDATA	



## 10.398.2 Constructor & Destructor Documentation

### 10.398.2.1 XMLPrinter()

```
gdcM::XMLPrinter::XMLPrinter ( )
```

### 10.398.2.2 ~XMLPrinter()

```
virtual gdcM::XMLPrinter::~~XMLPrinter ( ) [virtual]
```

## 10.398.3 Member Function Documentation

### 10.398.3.1 GetPrintStyle()

```
PrintStyles gdcM::XMLPrinter::GetPrintStyle ( ) const [inline]
```

### 10.398.3.2 HandleBulkData()

```
virtual void gdcM::XMLPrinter::HandleBulkData (
    const char * uuid,
    const TransferSyntax & ts,
    const char * bulkdata,
    size_t bulklen ) [virtual]
```

Virtual function mechanism to allow application programmer to override the default mechanism for BulkData handling. By default GDCM will simply discard the BulkData and only write the UUID

### 10.398.3.3 Print()

```
void gdcM::XMLPrinter::Print (
    std::ostream & os )
```

#### 10.398.3.4 PrintDataElement()

```
VR gdcM::XMLPrinter::PrintDataElement (
    std::ostream & os,
    const Dicts & dicts,
    const DataSet & ds,
    const DataElement & de,
    const TransferSyntax & ts ) [protected]
```

#### 10.398.3.5 PrintDataSet()

```
void gdcM::XMLPrinter::PrintDataSet (
    const DataSet & ds,
    const TransferSyntax & ts,
    std::ostream & os )
```

#### 10.398.3.6 PrintSQ()

```
void gdcM::XMLPrinter::PrintSQ (
    const SequenceOfItems * sqi,
    const TransferSyntax & ts,
    std::ostream & os ) [protected]
```

#### 10.398.3.7 SetFile()

```
void gdcM::XMLPrinter::SetFile (
    File const & f ) [inline]
```

#### 10.398.3.8 SetStyle()

```
void gdcM::XMLPrinter::SetStyle (
    PrintStyles ps ) [inline]
```

### 10.398.4 Member Data Documentation

### 10.398.4.1 F

```
const File* gdcm::XMLPrinter::F [protected]
```

### 10.398.4.2 PrintStyle

```
PrintStyles gdcm::XMLPrinter::PrintStyle [protected]
```

The documentation for this class was generated from the following file:

- [gdcmXMLPrinter.h](#)

## 10.399 gdcm::XMLPrivateDictReader Class Reference

Class for representing a [XMLPrivateDictReader](#).

```
#include <gdcmXMLPrivateDictReader.h>
```

Inheritance diagram for gdcm::XMLPrivateDictReader:

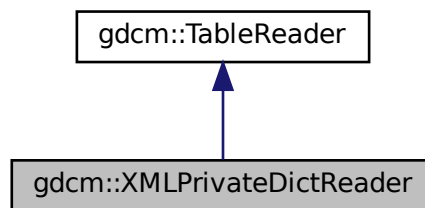

Collaboration diagram for gdcm::XMLPrivateDictReader:

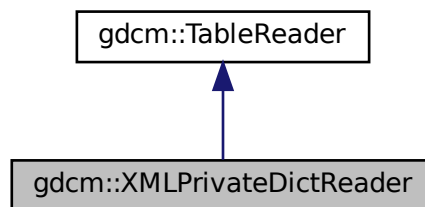

## Public Member Functions

- [XMLPrivateDictReader](#) ()
- [~XMLPrivateDictReader](#) ()
- void [CharacterDataHandler](#) (const char \*data, int length)
- void [EndElement](#) (const char \*name)
- const [PrivateDict](#) & [GetPrivateDict](#) ()
- void [StartElement](#) (const char \*name, const char \*\*atts)

## Protected Member Functions

- void [HandleDescription](#) (const char \*\*atts)
- void [HandleEntry](#) (const char \*\*atts)

### 10.399.1 Detailed Description

Class for representing a [XMLPrivateDictReader](#).

#### Note

bla Will read the Private.xml file

### 10.399.2 Constructor & Destructor Documentation

#### 10.399.2.1 XMLPrivateDictReader()

```
gdcM::XMLPrivateDictReader::XMLPrivateDictReader ( )
```

#### 10.399.2.2 ~XMLPrivateDictReader()

```
gdcM::XMLPrivateDictReader::~XMLPrivateDictReader ( ) [inline]
```

### 10.399.3 Member Function Documentation

### 10.399.3.1 CharacterDataHandler()

```
void gdcM::XMLPrivateDictReader::CharacterDataHandler (
    const char * data,
    int length ) [virtual]
```

Reimplemented from [gdcM::TableReader](#).

### 10.399.3.2 EndElement()

```
void gdcM::XMLPrivateDictReader::EndElement (
    const char * name ) [virtual]
```

Reimplemented from [gdcM::TableReader](#).

### 10.399.3.3 GetPrivateDict()

```
const PrivateDict& gdcM::XMLPrivateDictReader::GetPrivateDict ( ) [inline]
```

### 10.399.3.4 HandleDescription()

```
void gdcM::XMLPrivateDictReader::HandleDescription (
    const char ** atts ) [protected]
```

### 10.399.3.5 HandleEntry()

```
void gdcM::XMLPrivateDictReader::HandleEntry (
    const char ** atts ) [protected]
```

### 10.399.3.6 StartElement()

```
void gdcM::XMLPrivateDictReader::StartElement (
    const char * name,
    const char ** atts ) [virtual]
```

Reimplemented from [gdcM::TableReader](#).

The documentation for this class was generated from the following file:

- [gdcMXMLPrivateDictReader.h](#)



# Chapter 11

## File Documentation

### 11.1 gdcmAAbortPDU.h File Reference

```
#include "gdcmTypes.h"  
#include "gdcmBasePDU.h"  
Include dependency graph for gdcmAAbortPDU.h:
```

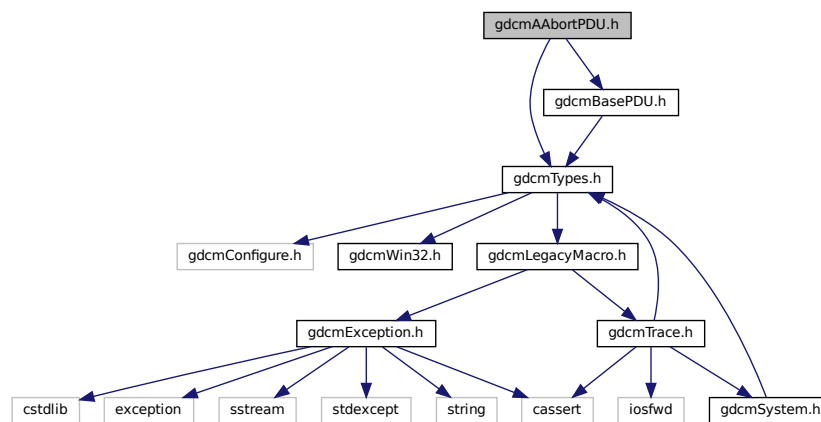

### Classes

- class `gdcm::network::AAbortPDU`  
*AAbortPDU*.

### Namespaces

- `gdcm`
- `gdcm::network`

## 11.2 gdcmAAssociateACPDU.h File Reference

```
#include "gdcmTypes.h"
#include "gdcmApplicationContext.h"
#include "gdcmPresentationContextAC.h"
#include "gdcmUserInformation.h"
#include "gdcmBasePDU.h"
#include <vector>
```

Include dependency graph for gdcmAAssociateACPDU.h:

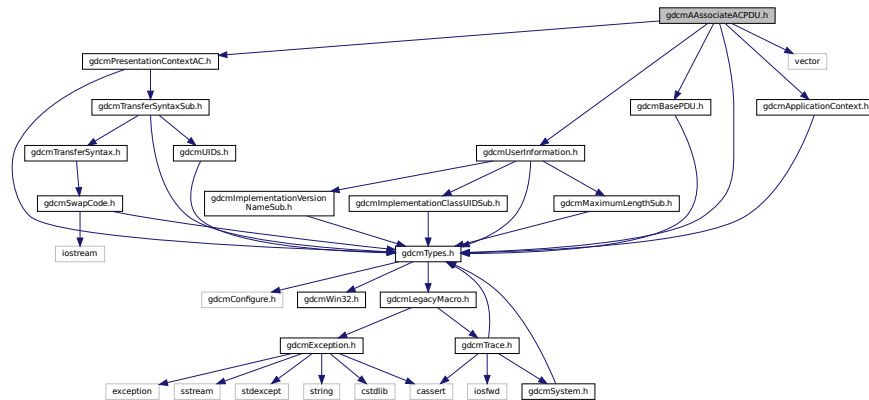

### Classes

- class [gdcm::network::AAssociateACPDU](#)  
*AAssociateACPDU*.

### Namespaces

- [gdcm](#)
- [gdcm::network](#)

## 11.3 gdcmAAssociateRJPDU.h File Reference

```
#include "gdcmTypes.h"
#include "gdcmBasePDU.h"
```



Include dependency graph for gdcmAAssociateRJPDU.h:

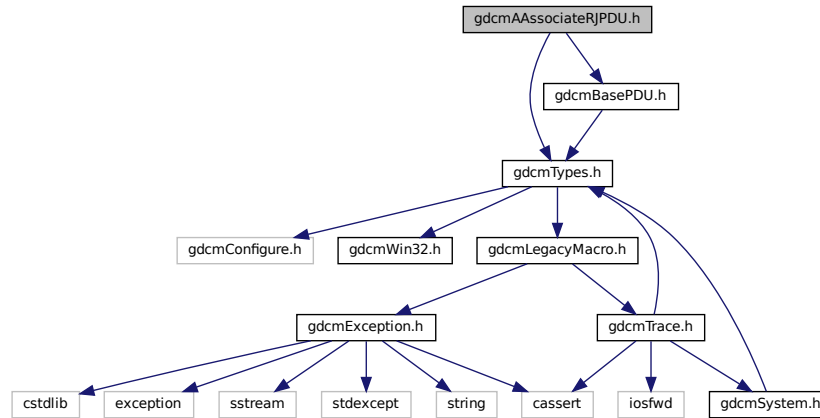

## Classes

- class [gdcm::network::AAssociateRJPDU](#)  
*AAssociateRJPDU.*

## Namespaces

- [gdcm](#)
- [gdcm::network](#)

## 11.4 gdcmAAssociateRQPDU.h File Reference

```

#include "gdcmTypes.h"
#include "gdcmVR.h"
#include "gdcmApplicationContext.h"
#include "gdcmPresentationContextRQ.h"
#include "gdcmUserInformation.h"
#include "gdcmBasePDU.h"

```

Include dependency graph for gdcmAAssociateRQPDU.h:

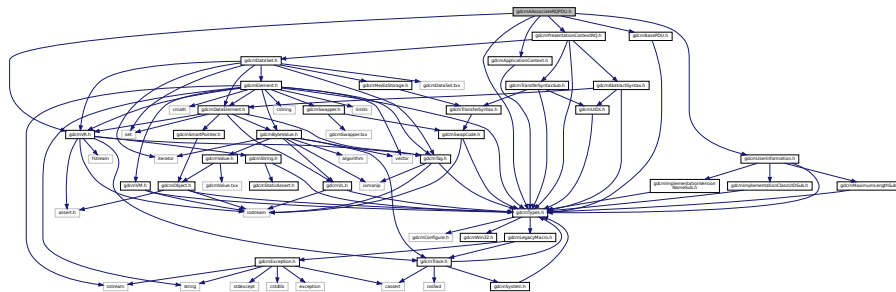

## Classes

- class [gdcm::network::AAssociateRQPDU](#)  
*AAssociateRQPDU.*

## Namespaces

- [gdcm](#)
- [gdcm::network](#)

## 11.5 gdcmAbstractSyntax.h File Reference

```
#include "gdcmTypes.h"
#include "gdcmUIDs.h"
#include "gdcmDataElement.h"
```

Include dependency graph for gdcmAbstractSyntax.h:

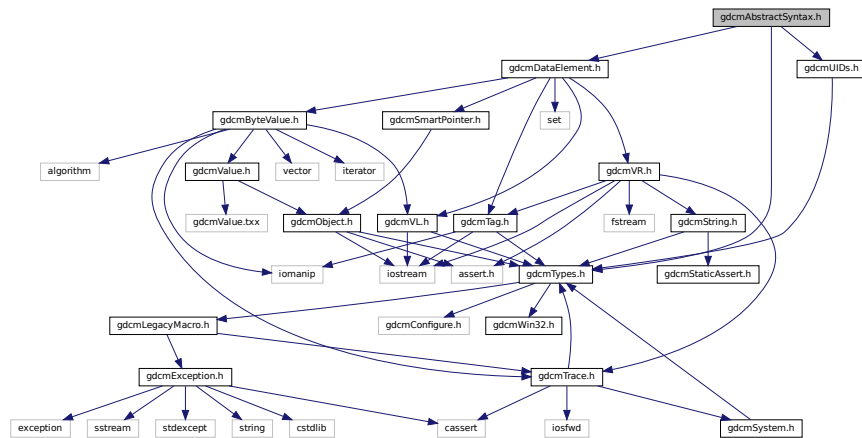

This graph shows which files directly or indirectly include this file:

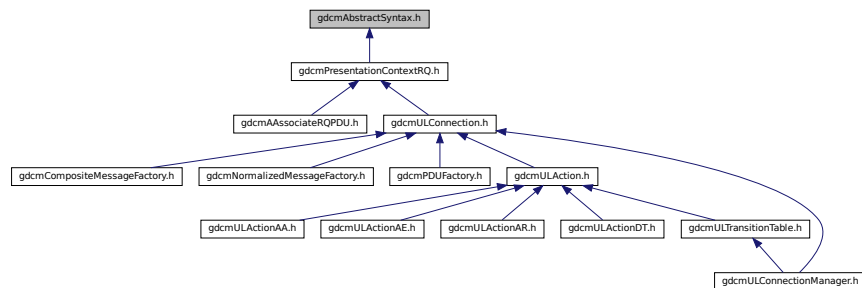

### Classes

- class [gdcmanonymizeEvent::AbstractSyntax](#)  
*AbstractSyntax.*

### Namespaces

- [gdcmanonymizeEvent](#)
- [gdcmanonymizeEvent::network](#)

## 11.6 gdcmanonymizeEvent.h File Reference

```
#include "gdcmanonymizeEvent.h"
#include "gdcmanonymizeEventTag.h"
Include dependency graph for gdcmanonymizeEvent.h:
```

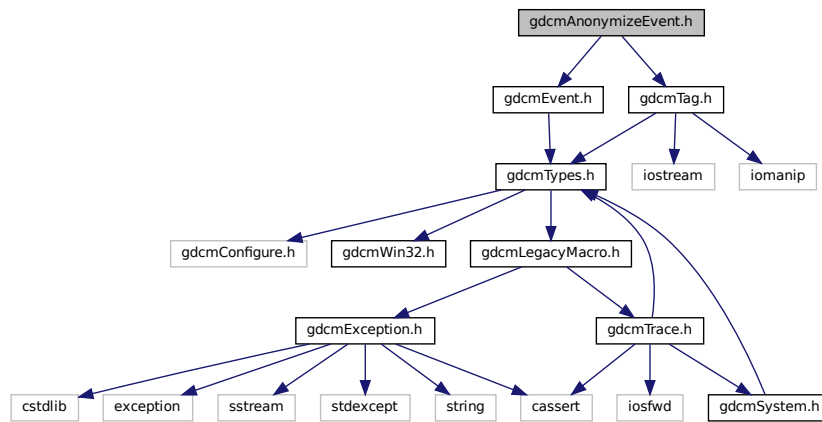

This graph shows which files directly or indirectly include this file:

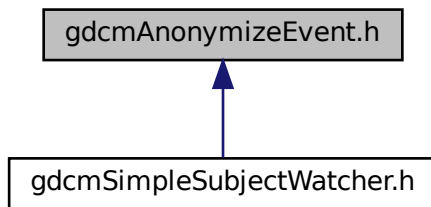

## Classes

- class [gdcm::AnonymizeEvent](#)  
*AnonymizeEvent.*

## Namespaces

- [gdcm](#)

## 11.7 gdcmAnonymizer.h File Reference

```
#include "gdcmFile.h"
#include "gdcmSubject.h"
#include "gdcmEvent.h"
#include "gdcmSmartPointer.h"
#include <map>
```

Include dependency graph for gdcmAnonymizer.h:

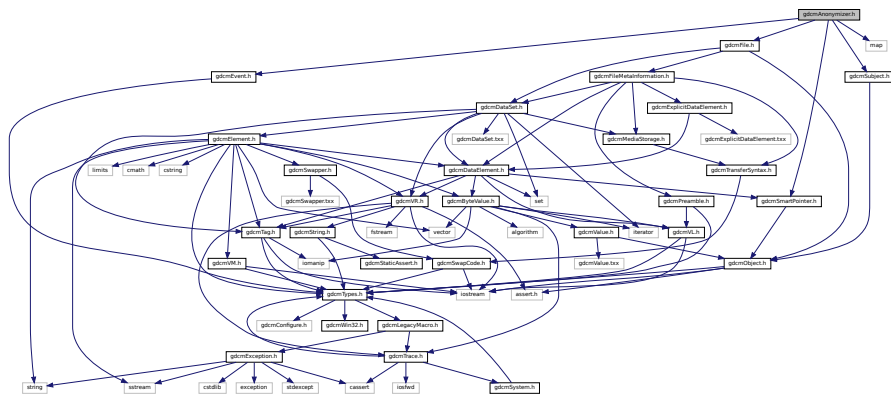

## Classes

- class [gdcm::Anonymizer](#)  
*Anonymizer.*

## Namespaces

- [gdcm](#)

## 11.8 gdcmApplicationContext.h File Reference

```
#include "gdcmTypes.h"
```

Include dependency graph for gdcmApplicationContext.h:

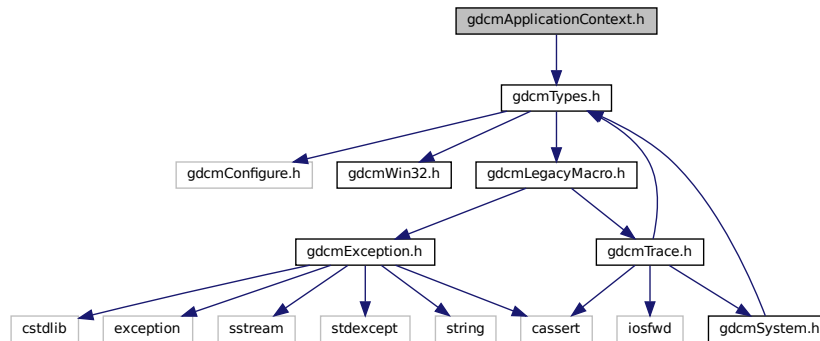

This graph shows which files directly or indirectly include this file:

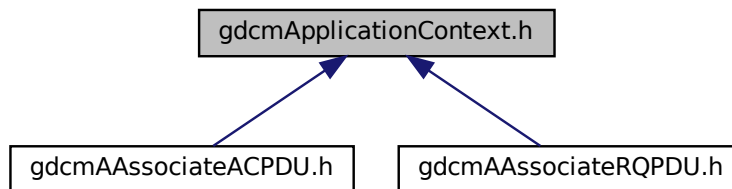

### Classes

- class `gdcm::network::ApplicationContext`  
*ApplicationContext.*

### Namespaces

- `gdcm`
- `gdcm::network`

## 11.9 gdcmApplicationEntity.h File Reference

```
#include "gdcmTypes.h"
#include <vector>
#include <stdlib.h>
```

Include dependency graph for gdcmApplicationEntity.h:

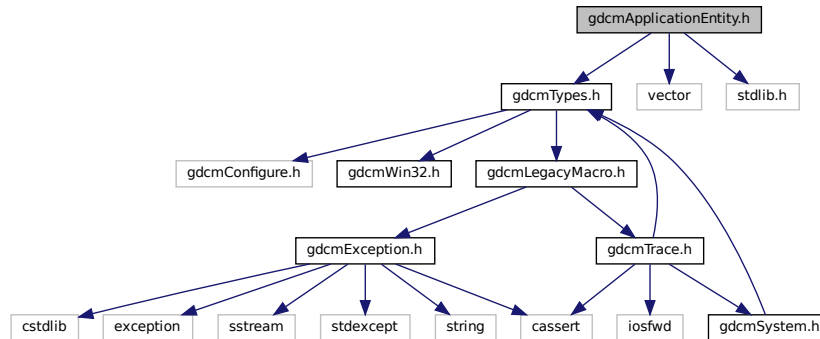

### Classes

- class [gdcm::ApplicationEntity](#)  
*ApplicationEntity.*

### Namespaces

- [gdcm](#)

## 11.10 gdcmAReleaseRPPDU.h File Reference

```
#include "gdcmTypes.h"
#include "gdcmBasePDU.h"
```

Include dependency graph for gdcmAReleaseRPPDU.h:

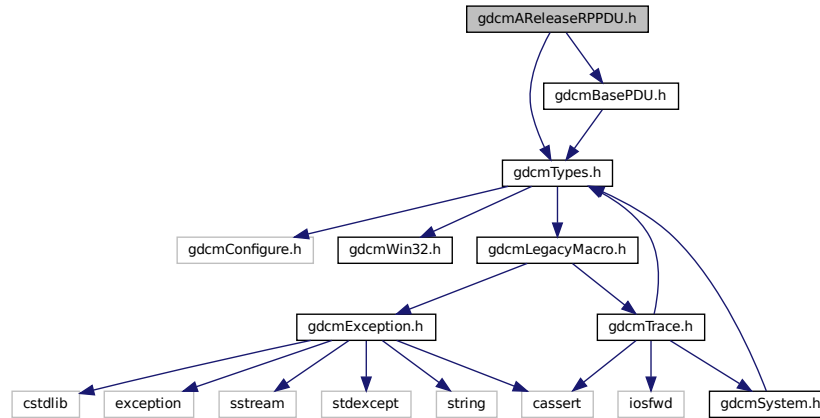

## Classes

- class [gdcm::network::AReleaseRPPDU](#)  
*AReleaseRPPDU*.

## Namespaces

- [gdcm](#)
- [gdcm::network](#)

## 11.11 gdcmAReleaseRQPDU.h File Reference

```
#include "gdcmTypes.h"
#include "gdcmBasePDU.h"
```

Include dependency graph for `gdcmAResponseRQPDU.h`:

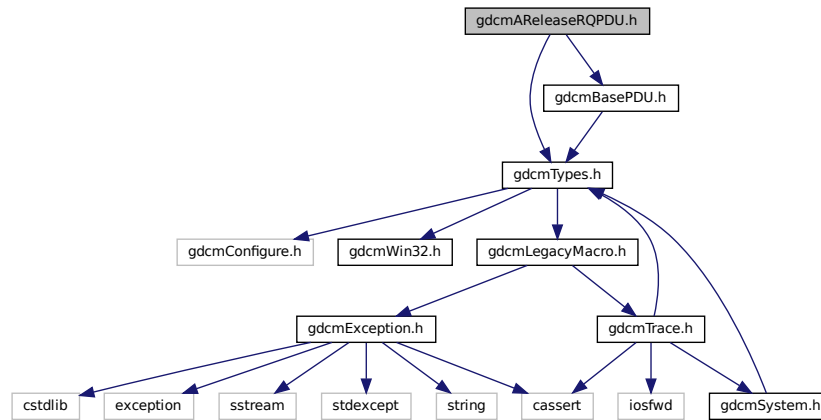

## Classes

- class `gdcm::network::AResponseRQPDU`  
*AResponseRQPDU*.

## Namespaces

- `gdcm`
- `gdcm::network`

## 11.12 gdcmARTIMTimer.h File Reference

This graph shows which files directly or indirectly include this file:

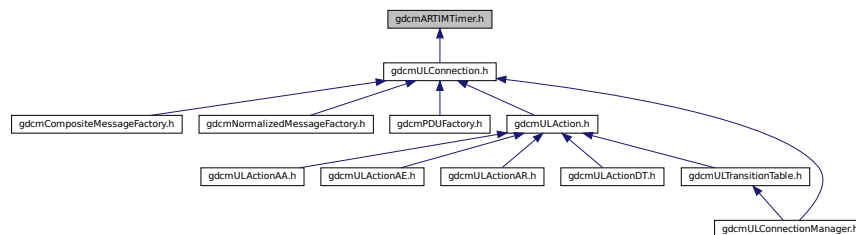



## Classes

- class [gdcm::network::ARTIMTimer](#)  
*ARTIMTimer.*

## Namespaces

- [gdcm](#)
- [gdcm::network](#)

## 11.13 gdcmASN1.h File Reference

```
#include "gdcmTypes.h"
```

Include dependency graph for gdcmASN1.h:

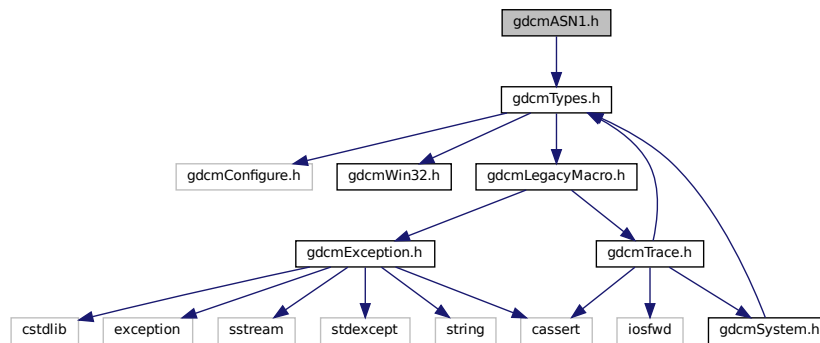

## Classes

- class [gdcm::ASN1](#)  
*Class for ASN1.*

## Namespaces

- [gdcm](#)

## 11.14 gdcmAsynchronousOperationsWindowSub.h File Reference

```
#include "gdcmTypes.h"
```

Include dependency graph for gdcmAsynchronousOperationsWindowSub.h:

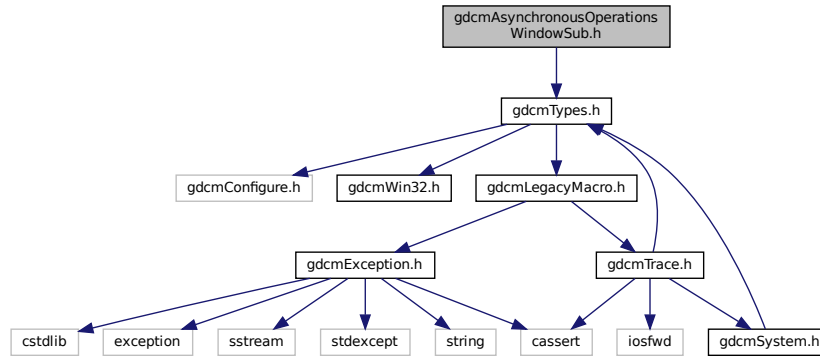

### Classes

- class [gdcm::network::AsynchronousOperationsWindowSub](#)  
*AsynchronousOperationsWindowSub.*

### Namespaces

- [gdcm](#)
- [gdcm::network](#)

## 11.15 gdcmAttribute.h File Reference

```
#include "gdcmTypes.h"
#include "gdcmVR.h"
#include "gdcmTagToType.h"
#include "gdcmVM.h"
#include "gdcmElement.h"
#include "gdcmDataElement.h"
#include "gdcmDataSet.h"
#include "gdcmStaticAssert.h"
#include <string>
#include <vector>
```



## Namespaces

- [gdcm](#)

## 11.16 gdcmAudioCodec.h File Reference

```
#include "gdcmCodec.h"
```

Include dependency graph for gdcmAudioCodec.h:

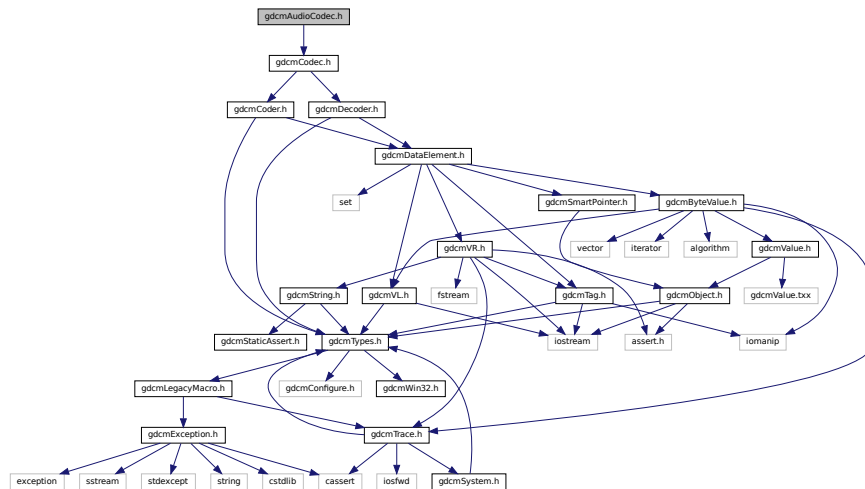

## Classes

- class [gdcm::AudioCodec](#)  
*AudioCodec.*

## Namespaces

- [gdcm](#)





## Classes

- class [gdcmbasePDU::BaseNormalizedMessage](#)  
*BaseNormalizedMessage*.

## Namespaces

- [gdcmbasePDU](#)
- [gdcmbasePDU::network](#)

## 11.20 gdcmbasePDU.h File Reference

```
#include "gdcmbasePDU.h"
```

Include dependency graph for gdcmbasePDU.h:

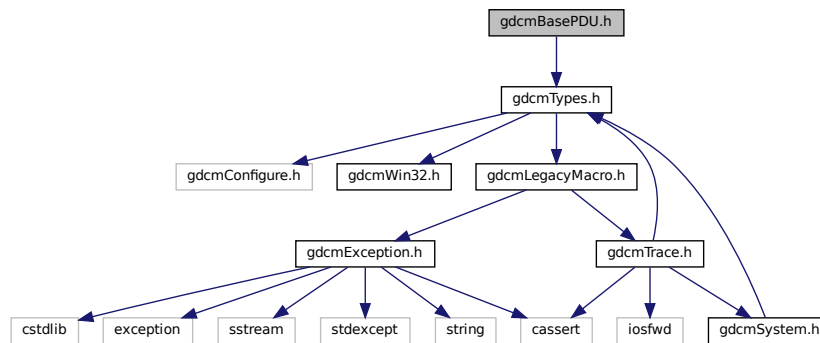

This graph shows which files directly or indirectly include this file:

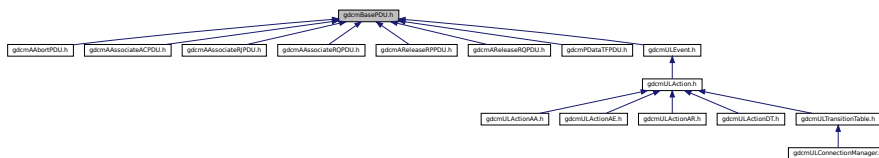

## Classes

- class [gdcmbasePDU::BasePDU](#)  
*BasePDU*.

## Namespaces

- [gdc](#)
- [gdc::network](#)

## 11.21 gdcBaseQuery.h File Reference

```
#include "gdcDataSet.h"
```

```
#include "gdcUIDs.h"
```

```
#include "gdcObject.h"
```

Include dependency graph for `gdcBaseQuery.h`:

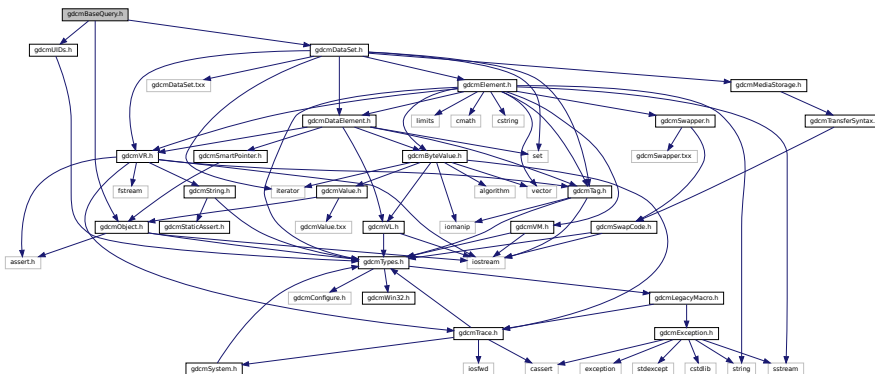

This graph shows which files directly or indirectly include this file:

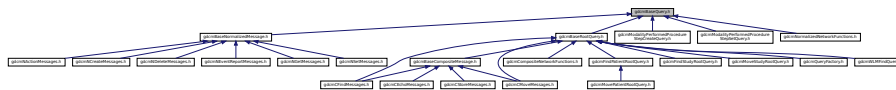

## Classes

- class [gdc::BaseQuery](#)  
*BaseQuery*.

## Namespaces

- [gdc](#)

## Enumerations

- enum [gdc::ENQueryType](#) {  
  [gdc::eCreateMMPS](#) = 0 ,  
  [gdc::eSetMMPS](#) }



## 11.22 gdcMBaseRootQuery.h File Reference

```
#include "gdcMDataSet.h"
#include "gdcMUIDs.h"
#include "gdcMBaseQuery.h"
#include "gdcMQueryPatient.h"
#include "gdcMQueryStudy.h"
#include "gdcMQuerySeries.h"
#include "gdcMQueryImage.h"
```

Include dependency graph for gdcMBaseRootQuery.h:

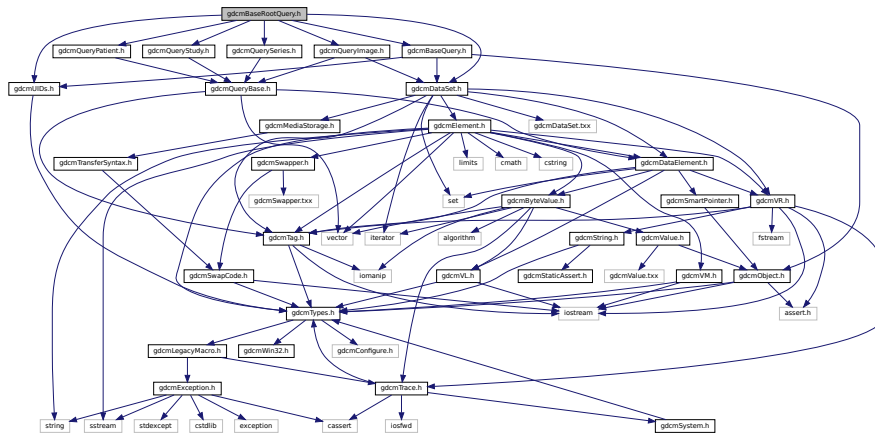

This graph shows which files directly or indirectly include this file:



### Classes

- class [gdcM::BaseRootQuery](#)  
*BaseRootQuery.*

### Namespaces

- [gdcM](#)

## Enumerations

- enum `gdcm::EQueryLevel` {  
`gdcm::ePatient` = 0 ,  
`gdcm::eStudy` = 1 ,  
`gdcm::eSeries` = 2 ,  
`gdcm::eImage` = 3 }
- enum `gdcm::EQueryType` {  
`gdcm::eFind` = 0 ,  
`gdcm::eMove` ,  
`gdcm::eWLMFind` }

## 11.23 gdcmBasicOffsetTable.h File Reference

```
#include "gdcmFragment.h"
```

Include dependency graph for `gdcmBasicOffsetTable.h`:

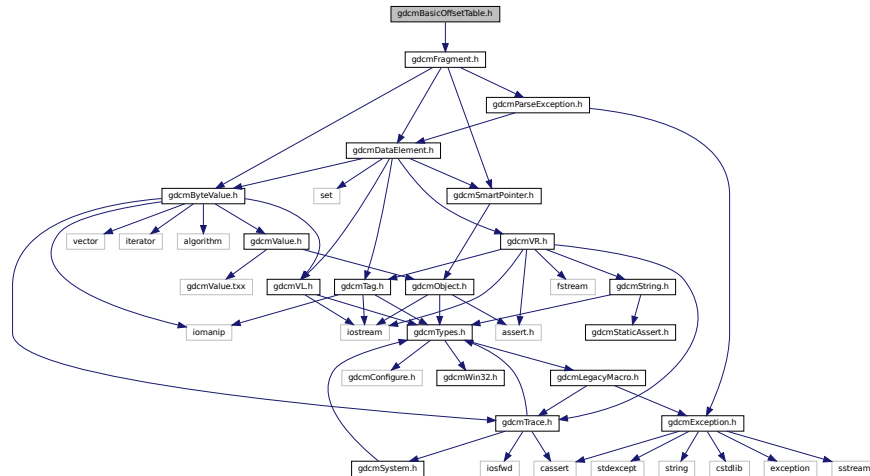

This graph shows which files directly or indirectly include this file:

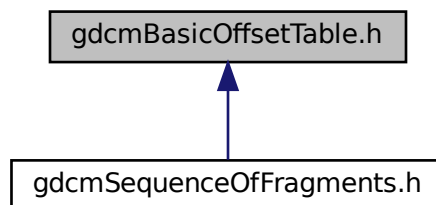



## Classes

- class [gdcm::Bitmap](#)  
*Bitmap class.*

## Namespaces

- [gdcm](#)

## 11.25 gdcmBitmapToBitmapFilter.h File Reference

```
#include "gdcmBitmap.h"
```

Include dependency graph for gdcmBitmapToBitmapFilter.h:

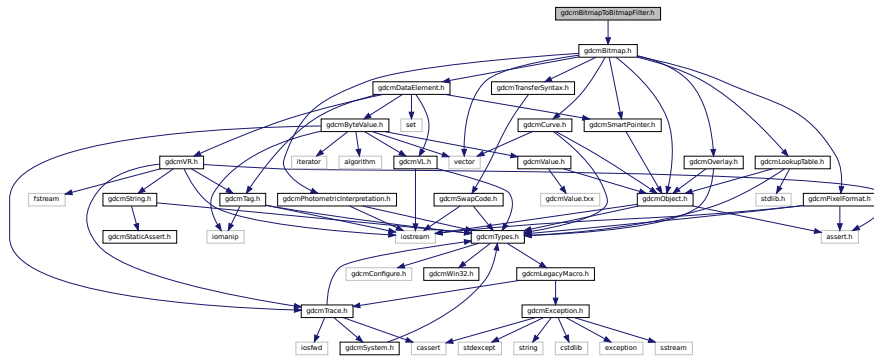

This graph shows which files directly or indirectly include this file:

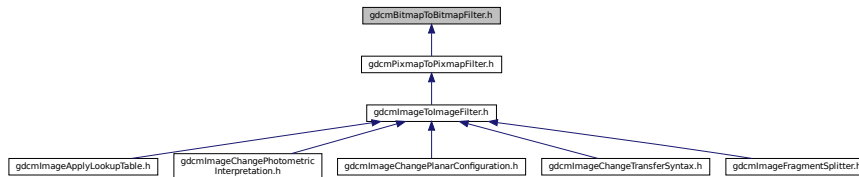

## Classes

- class [gdcm::BitmapToBitmapFilter](#)  
*BitmapToBitmapFilter class.*

## Namespaces

- [gdcm](#)

## 11.26 gdcmBoxRegion.h File Reference

```
#include "gdcmRegion.h"
```

Include dependency graph for gdcmBoxRegion.h:

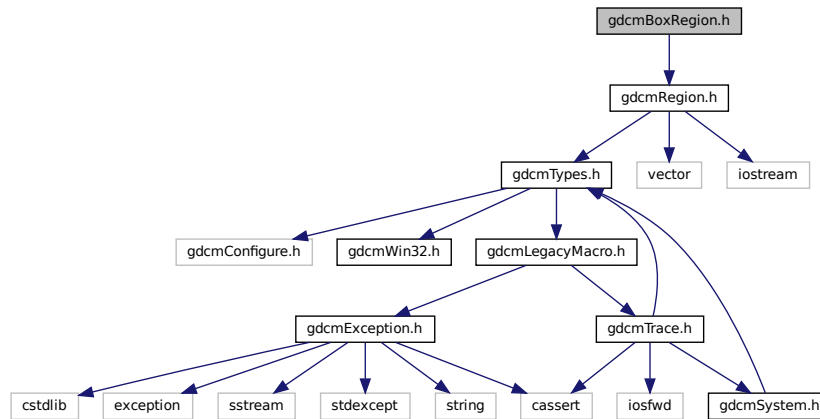

## Classes

- class [gdcm::BoxRegion](#)  
*Class for manipulation box region.*

## Namespaces

- [gdcm](#)

## 11.27 gdcmByteBuffer.h File Reference

```
#include "gdcmTypes.h"
```

```
#include <vector>
```

```
#include <assert.h>
```

```
#include <string.h>
```

Include dependency graph for `gdcmByteBuffer.h`:

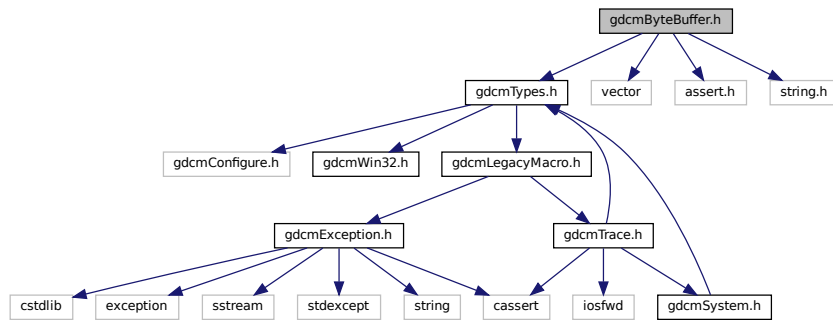

This graph shows which files directly or indirectly include this file:

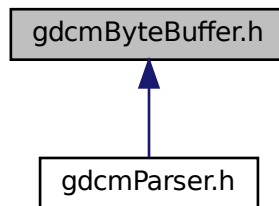

## Classes

- class `gdcm::ByteBuffer`  
*ByteBuffer*.

## Namespaces

- `gdcm`

## 11.28 gdcmByteSwap.h File Reference

```
#include "gdcmTypes.h"
#include "gdcmSwapCode.h"
#include "gdcmByteSwap.txx"
```

Include dependency graph for gdcmByteSwap.h:

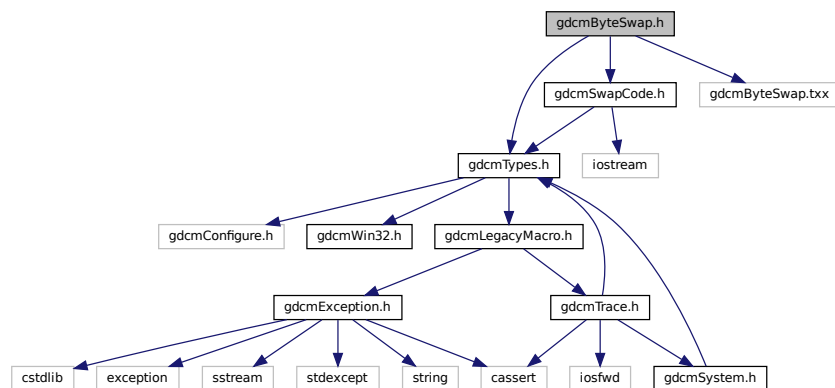

### Classes

- class [gdcm::ByteSwap< T >](#)  
*ByteSwap.*

### Namespaces

- [gdcm](#)

## 11.29 gdcmByteSwapFilter.h File Reference

```
#include "gdcmDataSet.h"
```

Include dependency graph for gdcmByteSwapFilter.h:

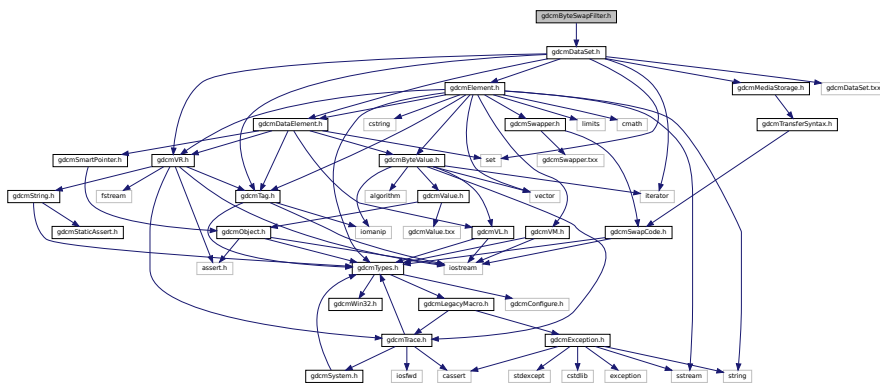

## Classes

- class [gdcm::ByteSwapFilter](#)  
*ByteSwapFilter.*

## Namespaces

- [gdcm](#)

## 11.30 gdcmByteValue.h File Reference

```
#include "gdcmValue.h"
#include "gdcmTrace.h"
#include "gdcmVL.h"
#include <vector>
#include <iterator>
#include <iomanip>
#include <algorithm>
```

Include dependency graph for gdcmByteValue.h:

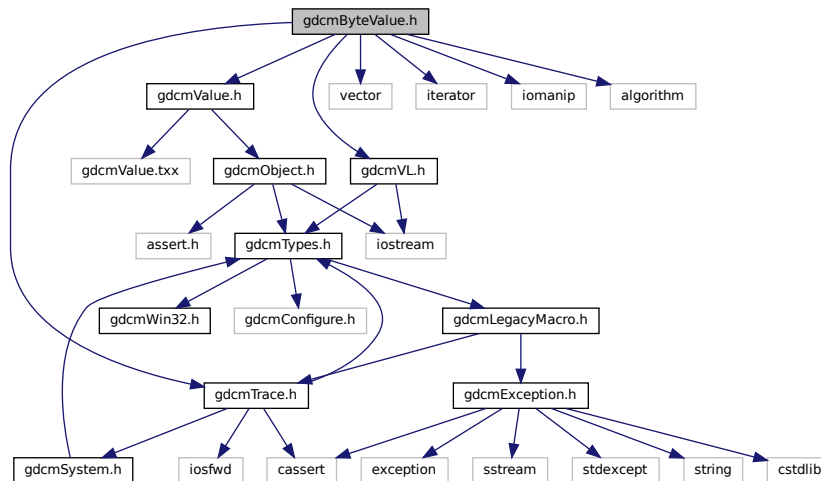

This graph shows which files directly or indirectly include this file:

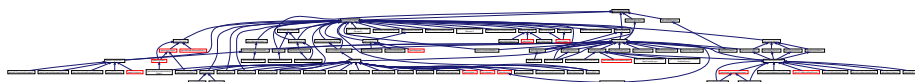



## Classes

- class [gdcml::ByteValue](#)  
Class to represent binary value (array of bytes)

## Namespaces

- [gdcml](#)

## 11.31 gdcmlCAPICryptoFactory.h File Reference

```
#include "gdcmlCryptoFactory.h"
```

Include dependency graph for gdcmlCAPICryptoFactory.h:

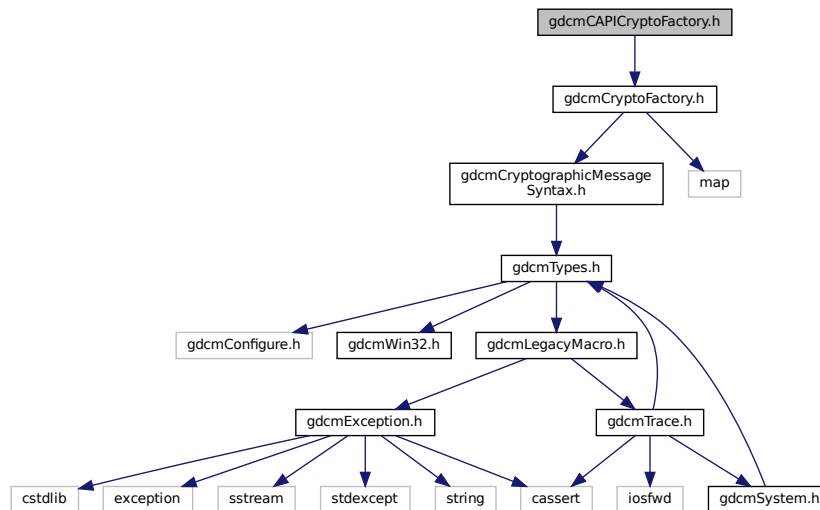

## Classes

- class [gdcml::CAPICryptoFactory](#)

## Namespaces

- [gdcml](#)

## 11.32 gdcmlCAPICryptographicMessageSyntax.h File Reference

```
#include "gdcmlCryptographicMessageSyntax.h"
#include <windows.h>
#include <wincrypt.h>
#include <vector>
```

Include dependency graph for gdcmlCAPICryptographicMessageSyntax.h:

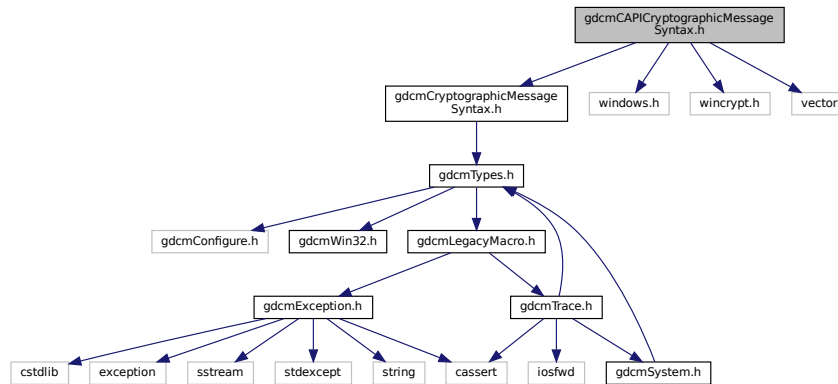

### Classes

- class [gdcml::CAPICryptographicMessageSyntax](#)

### Namespaces

- [gdcml](#)

## 11.33 gdcmlCEchoMessages.h File Reference

```
#include "gdcmlBaseCompositeMessage.h"
```

Include dependency graph for gdcmCEchoMessages.h:

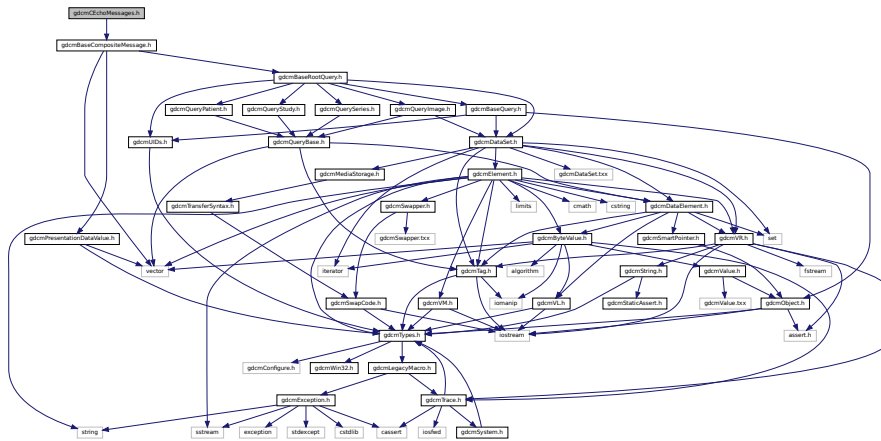

## Classes

- class [gdcm::network::CEchoRQ](#)  
*CEchoRQ.*
- class [gdcm::network::CEchoRSP](#)  
*CEchoRSP this file defines the messages for the cecho action.*

## Namespaces

- [gdcm](#)
- [gdcm::network](#)

## 11.34 gdcmCFindMessages.h File Reference

```
#include "gdcmBaseCompositeMessage.h"
#include "gdcmBaseRootQuery.h"
```





Include dependency graph for `gdcMCodec.h`:

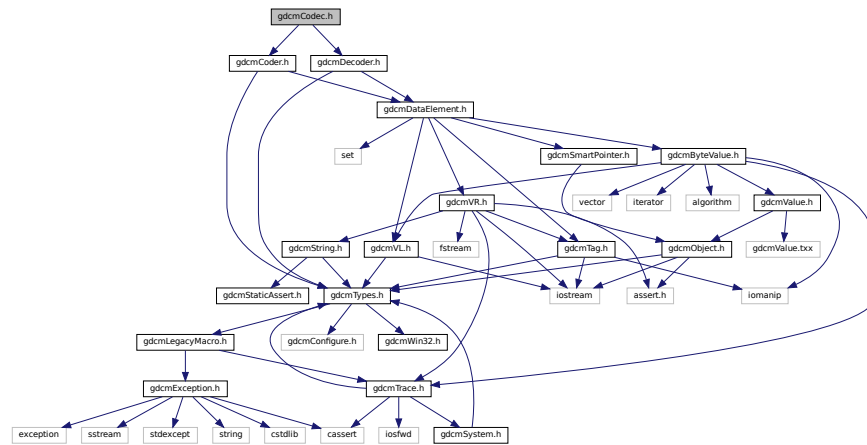

This graph shows which files directly or indirectly include this file:

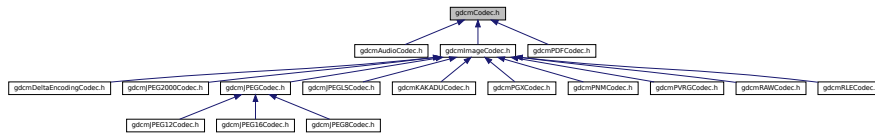

## Classes

- class `gdcM::Codec`  
*Codec class.*

## Namespaces

- `gdcM`

## 11.37 gdcMCoder.h File Reference

```
#include "gdcMTypes.h"
#include "gdcMDataElement.h"
```

Include dependency graph for gdcmCoder.h:

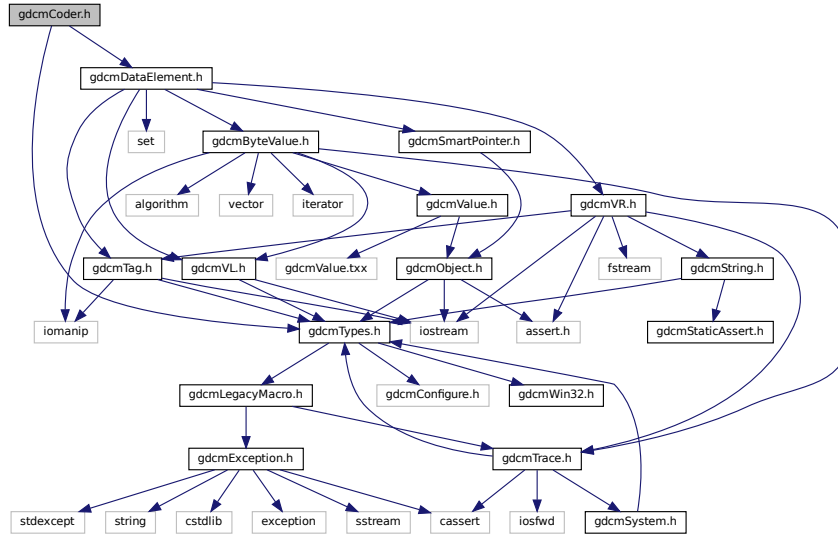

This graph shows which files directly or indirectly include this file:

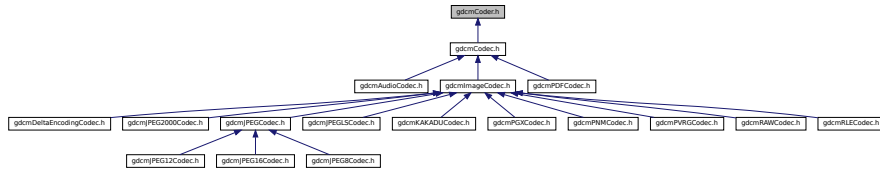

**Classes**

- class [gdcm::Coder](#)  
*Coder.*

**Namespaces**

- [gdcm](#)

## 11.38 gdcmCodeString.h File Reference

```
#include "gdcmString.h"
```

Include dependency graph for gdcmCodeString.h:

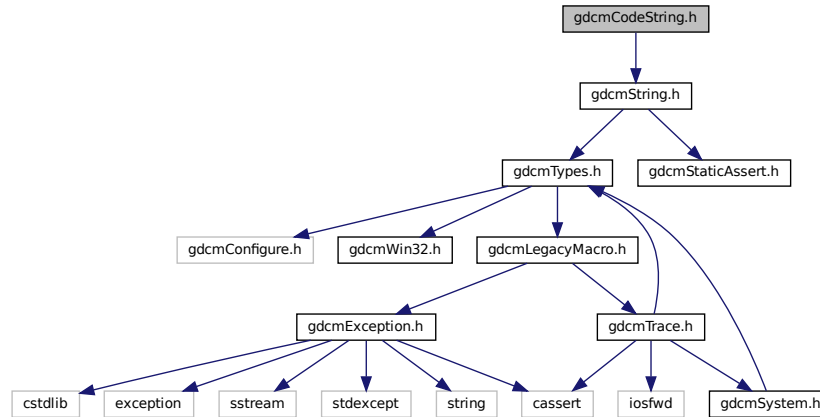

### Classes

- class `gdcm::CodeString`  
*CodeString.*

### Namespaces

- `gdcm`

### Functions

- bool `gdcm::operator!=` (const CodeString &ref, const CodeString &cs)
- `std::ostream &gdcm::operator<<` (std::ostream &os, const CodeString &str)
- bool `gdcm::operator==` (const CodeString &ref, const CodeString &cs)



## 11.39 gdcMCommand.h File Reference

```
#include "gdcMSubject.h"
```

Include dependency graph for gdcMCommand.h:

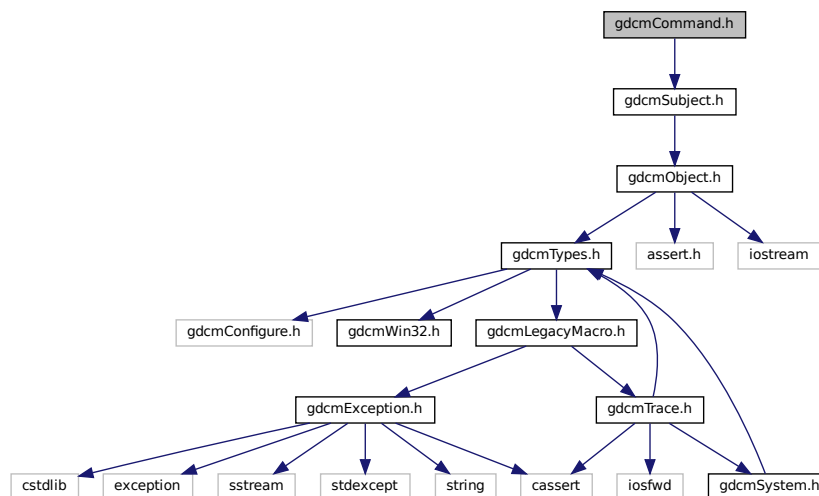

This graph shows which files directly or indirectly include this file:

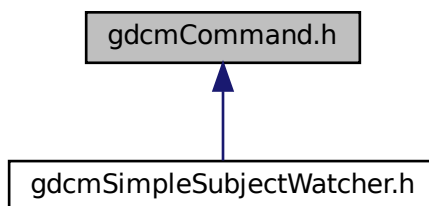

### Classes

- class [gdcM::Command](#)  
*Command superclass for callback/observer methods.*
- class [gdcM::MemberCommand< T >](#)  
*Command subclass that calls a pointer to a member function.*
- class [gdcM::SimpleMemberCommand< T >](#)  
*Command subclass that calls a pointer to a member function.*

## Namespaces

- [gdcm](#)

## 11.40 gdcmCommandDataSet.h File Reference

```
#include "gdcmDataSet.h"
#include "gdcmDataElement.h"
```

Include dependency graph for gdcmCommandDataSet.h:

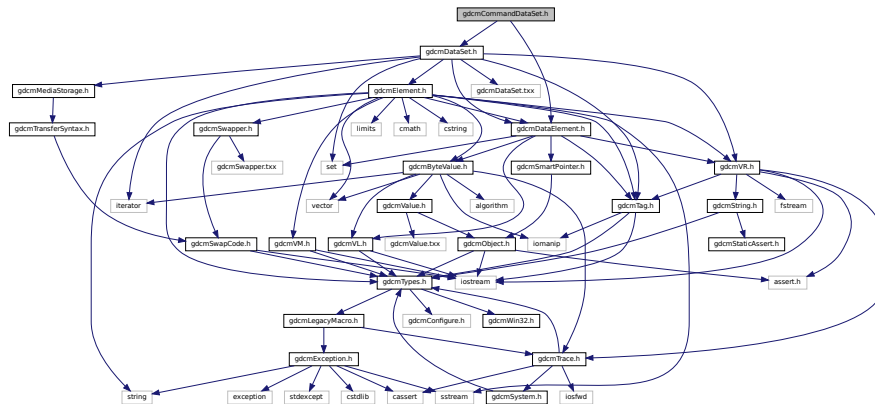

## Classes

- class [gdcm::CommandDataSet](#)  
Class to represent a *Command DataSet*.

## Namespaces

- [gdcm](#)

## Functions

- `std::ostream & gdcm::operator<< (std::ostream &os, const CommandDataSet &val)`

## 11.41 gdcCompositeMessageFactory.h File Reference

```
#include "gdcPresentationDataValue.h"
```

```
#include "gdcULConnection.h"
```

Include dependency graph for gdcCompositeMessageFactory.h:

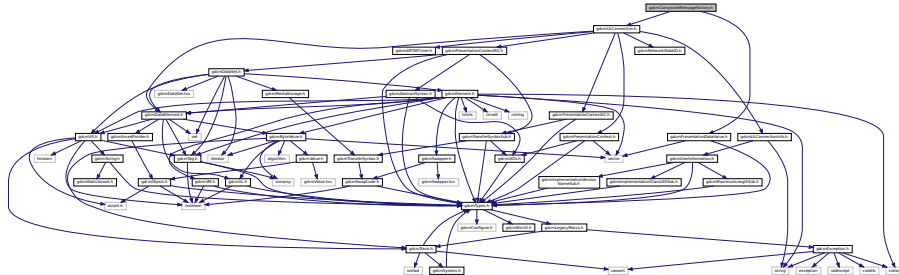

### Classes

- class [gdcm::network::CompositeMessageFactory](#)  
*CompositeMessageFactory.*

### Namespaces

- [gdcm](#)
- [gdcm::network](#)

## 11.42 gdcCompositeNetworkFunctions.h File Reference

```
#include "gdcDirectory.h"
```

```
#include "gdcBaseRootQuery.h"
```

```
#include <vector>
```

```
#include <string>
```

Include dependency graph for gdcCompositeNetworkFunctions.h:

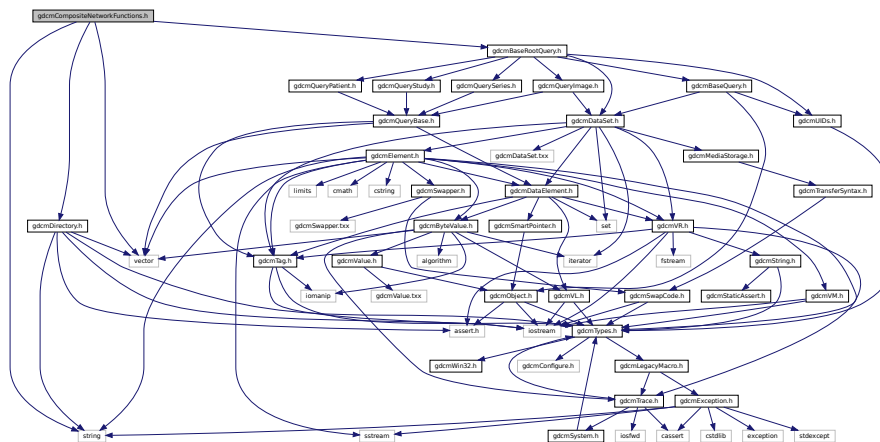

## Classes

- class [gdcm::CompositeNetworkFunctions](#)  
*Composite Network Functions.*

## Namespaces

- [gdcm](#)

## 11.43 gdcmConstCharWrapper.h File Reference

### Classes

- class [gdcm::ConstCharWrapper](#)  
*Do not use me.*

### Namespaces

- [gdcm](#)

## 11.44 gdcmCP246ExplicitDataElement.h File Reference

```
#include "gdcmDataElement.h"
#include "gdcmCP246ExplicitDataElement.txx"
Include dependency graph for gdcmCP246ExplicitDataElement.h:
```

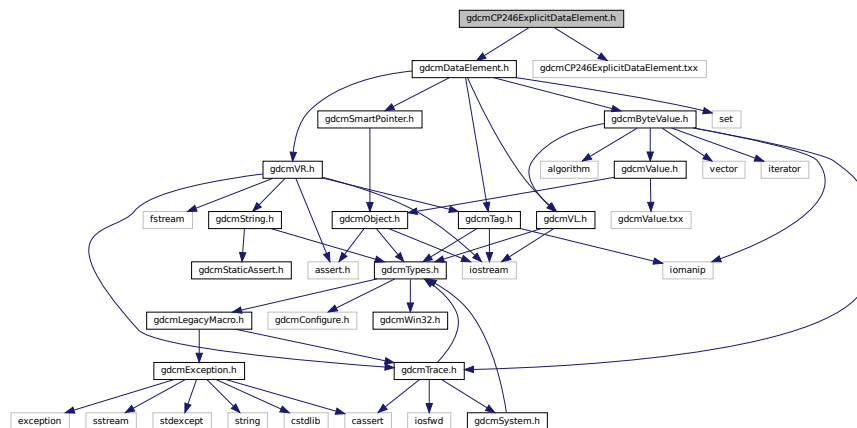

## Classes

- class [gdcm::CP246ExplicitDataElement](#)  
Class to read/write a *DataElement* as CP246Explicit Data *Element*.

## Namespaces

- [gdcm](#)

## 11.45 gdcmCryptoFactory.h File Reference

```
#include "gdcmCryptographicMessageSyntax.h"
#include <map>
```

Include dependency graph for gdcmCryptoFactory.h:

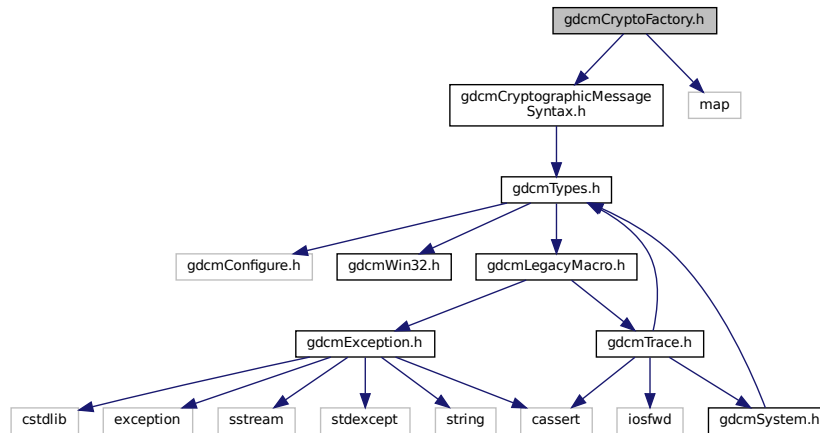

This graph shows which files directly or indirectly include this file:

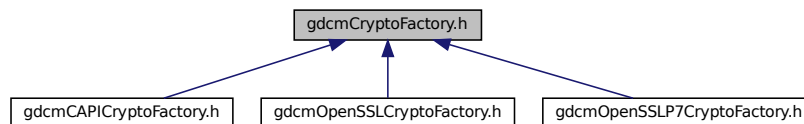

## Classes

- class [gdcm::CryptoFactory](#)  
Class to do handle the crypto factory.

## Namespaces

- [gdcm](#)

## 11.46 gdcmCryptographicMessageSyntax.h File Reference

```
#include "gdcmTypes.h"
```

Include dependency graph for gdcmCryptographicMessageSyntax.h:

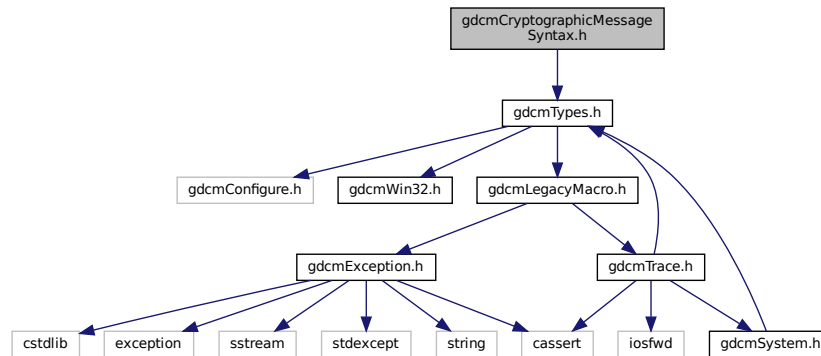

This graph shows which files directly or indirectly include this file:

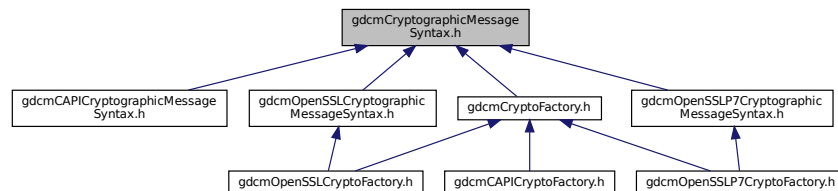

## Classes

- class [gdcm::CryptographicMessageSyntax](#)

## Namespaces

- [gdcm](#)

## 11.47 gdcmCSAElement.h File Reference

```
#include "gdcmTag.h"
#include "gdcmVM.h"
#include "gdcmVR.h"
#include "gdcmByteValue.h"
#include "gdcmSmartPointer.h"
```

Include dependency graph for gdcmCSAElement.h:

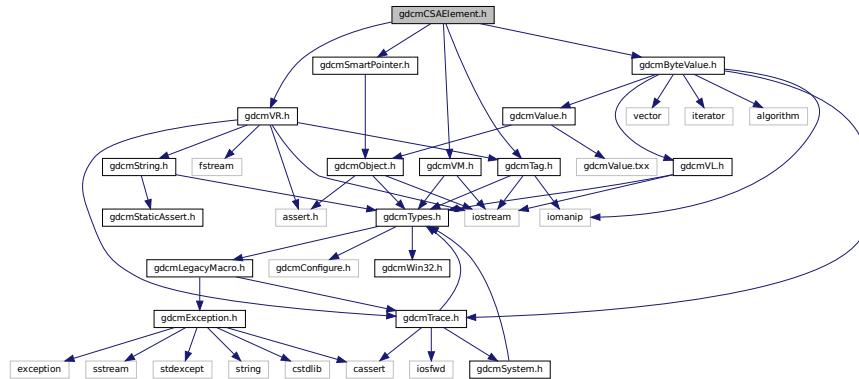

This graph shows which files directly or indirectly include this file:

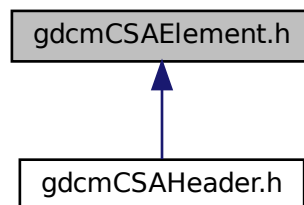

### Classes

- class [gdcm::CSAElement](#)  
Class to represent a CSA *Element*.

### Namespaces

- [gdcm](#)





## 11.49 gdcmCSAHeaderDict.h File Reference

```
#include "gdcmTypes.h"
#include "gdcmTag.h"
#include "gdcmCSAHeaderDictEntry.h"
#include <iostream>
#include <iomanip>
#include <set>
#include <exception>
```

Include dependency graph for gdcmCSAHeaderDict.h:

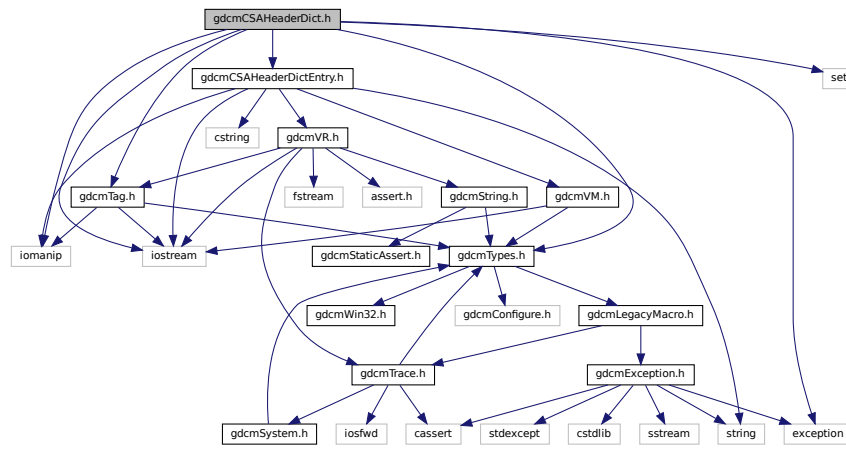

This graph shows which files directly or indirectly include this file:

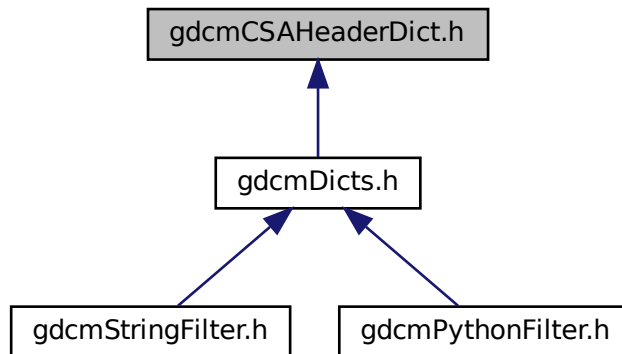

## Classes

- class [gdcm::CSAHeaderDict](#)  
*Class to represent a map of CSAHeaderDictEntry.*
- class [gdcm::CSAHeaderDictException](#)

## Namespaces

- [gdcm](#)

## Functions

- `std::ostream & gdcm::operator<< (std::ostream &os, const CSAHeaderDict &val)`

## 11.50 gdcmCSAHeaderDictEntry.h File Reference

```
#include "gdcmVR.h"
#include "gdcmVM.h"
#include <string>
#include <iostream>
#include <iomanip>
#include <cstring>
```

Include dependency graph for `gdcmCSAHeaderDictEntry.h`:

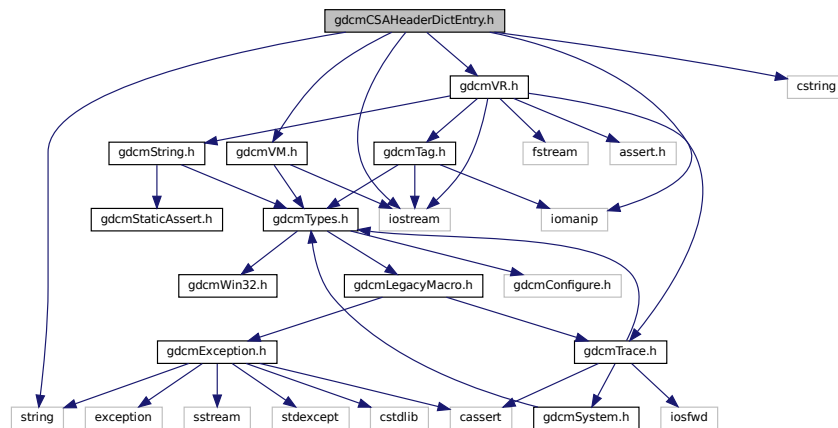

This graph shows which files directly or indirectly include this file:

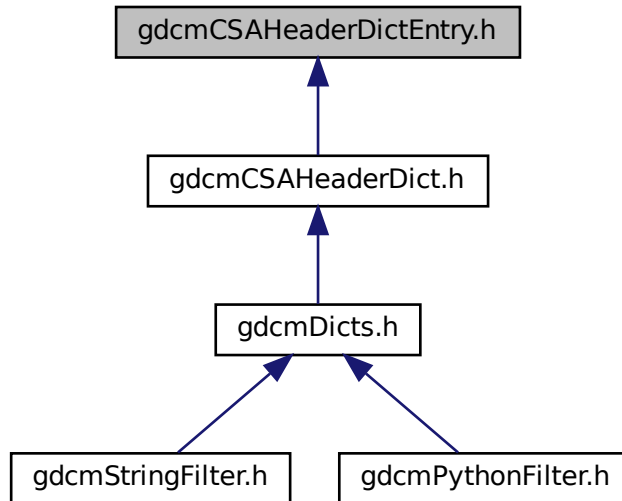

## Classes

- class [gdcm::CSAHeaderDictEntry](#)  
*Class to represent an Entry in the Dict.*

## Namespaces

- [gdcm](#)

## Functions

- `std::ostream & gdcm::operator<< (std::ostream &os, const CSAHeaderDictEntry &val)`

## 11.51 gdcmCStoreMessages.h File Reference

```
#include "gdcmBaseCompositeMessage.h"
```



Include dependency graph for gdcmCurve.h:

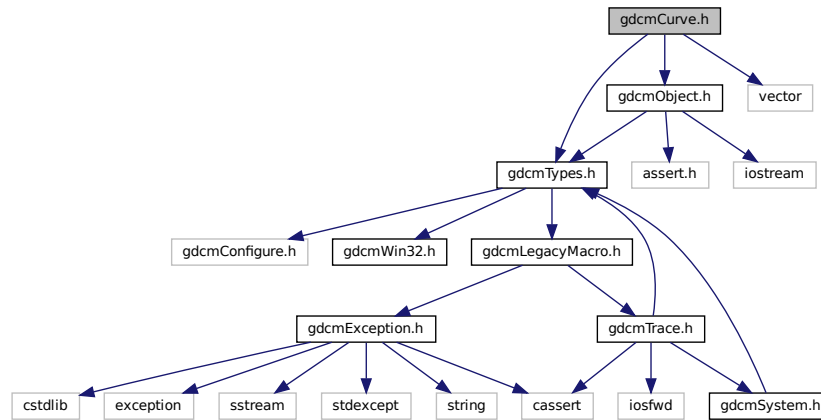

This graph shows which files directly or indirectly include this file:

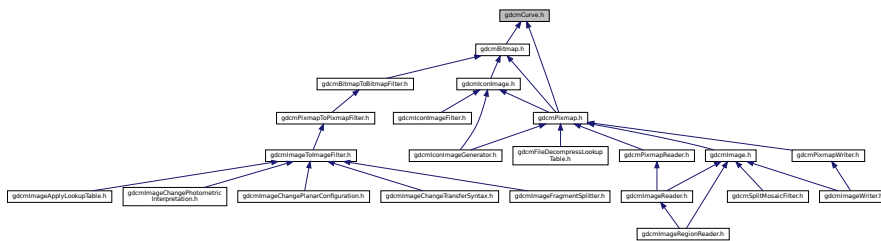

## Classes

- class [gdcm::Curve](#)  
*Curve* class to handle element 50xx,3000 *Curve* Data.

## Namespaces

- [gdcm](#)

## 11.53 gdcmDataElement.h File Reference

```

#include "gdcmTag.h"
#include "gdcmVL.h"
#include "gdcmVR.h"

```

```
#include "gdcmByteValue.h"
#include "gdcmSmartPointer.h"
#include <set>
Include dependency graph for gdcmDataElement.h:
```

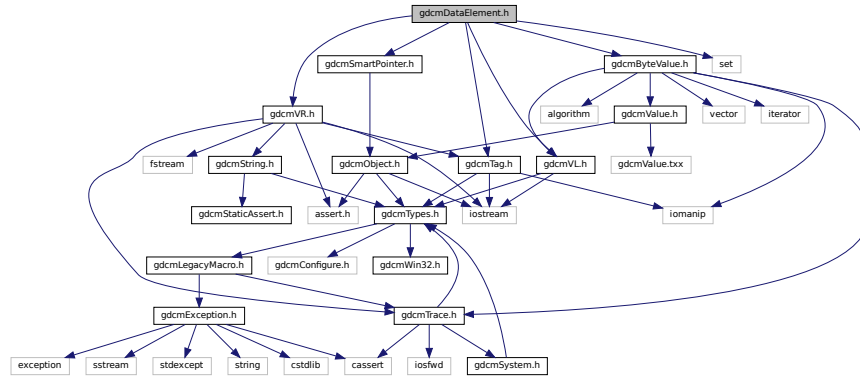

This graph shows which files directly or indirectly include this file:



## Classes

- class [gdcm::DataElement](#)  
*Class to represent a Data [Element](#) either Implicit or Explicit.*

## Namespaces

- [gdcm](#)

## Functions

- bool [gdcm::operator!=](#) (const DataElement &lhs, const DataElement &rhs)
- std::ostream & [gdcm::operator<<](#) (std::ostream &os, const DataElement &val)

## 11.54 gdcmDataEvent.h File Reference

```
#include "gdcmEvent.h"
```

Include dependency graph for gdcmDataEvent.h:

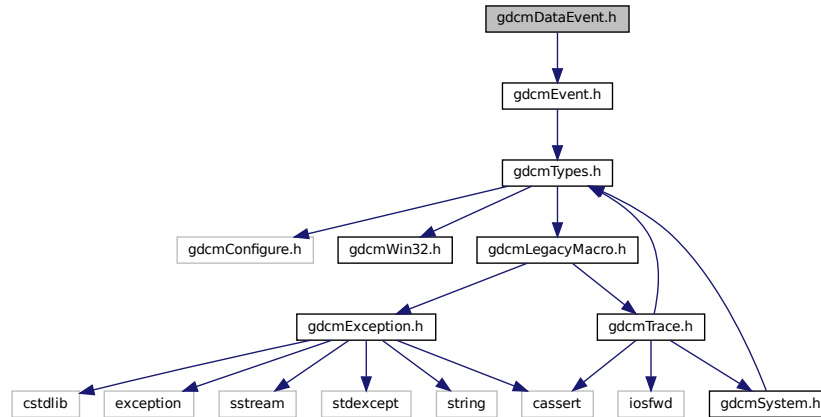

This graph shows which files directly or indirectly include this file:

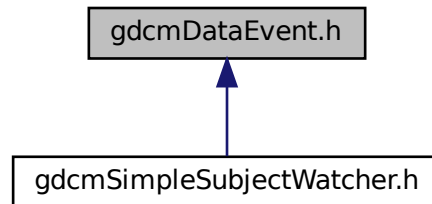

### Classes

- class [gdcm::DataEvent](#)  
*DataEvent.*

### Namespaces

- [gdcm](#)





## 11.56 gdcmDataSetEvent.h File Reference

```
#include "gdcmEvent.h"
#include "gdcmDataSet.h"
```

Include dependency graph for gdcmDataSetEvent.h:

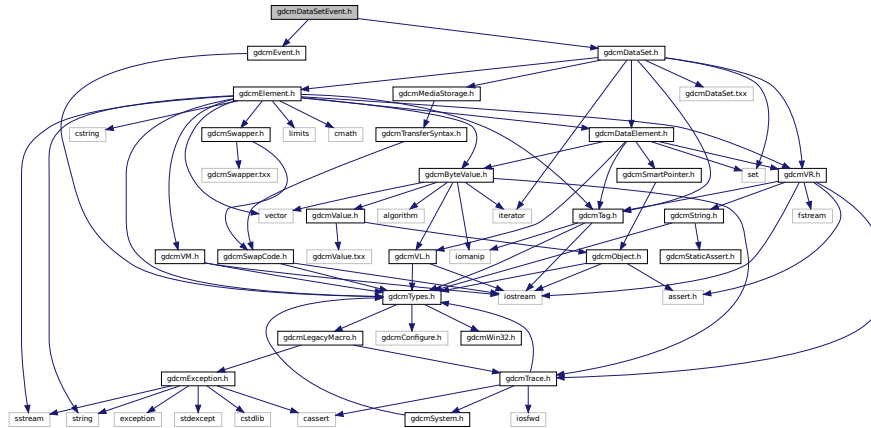

### Classes

- class [gdcm::DataSetEvent](#)  
*DataSetEvent.*

### Namespaces

- [gdcm](#)

## 11.57 gdcmDataSetHelper.h File Reference

```
#include "gdcmTypes.h"
#include "gdcmVR.h"
```

Include dependency graph for `gdcmDataSetHelper.h`:

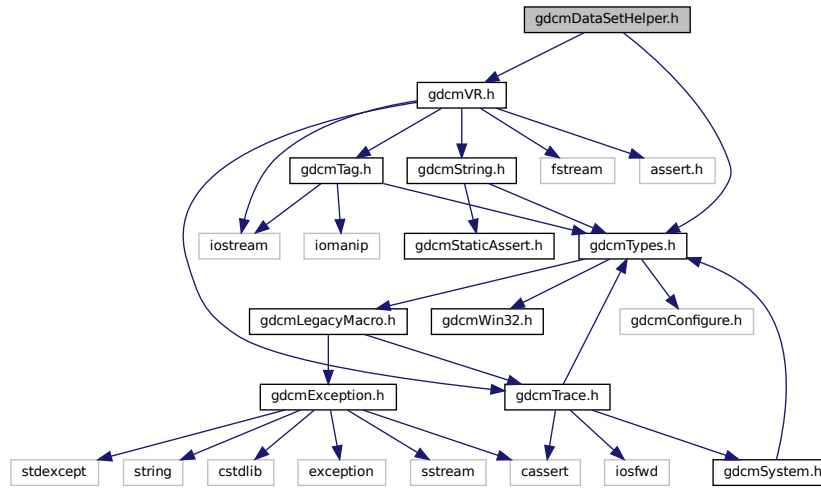

## Classes

- class [gdcm::DataSetHelper](#)  
*DataSetHelper* (internal class, not intended for user level)

## Namespaces

- [gdcm](#)

## 11.58 gdcmDecoder.h File Reference

```
#include "gdcmTypes.h"
#include "gdcmDataElement.h"
```

Include dependency graph for gdcmDecoder.h:

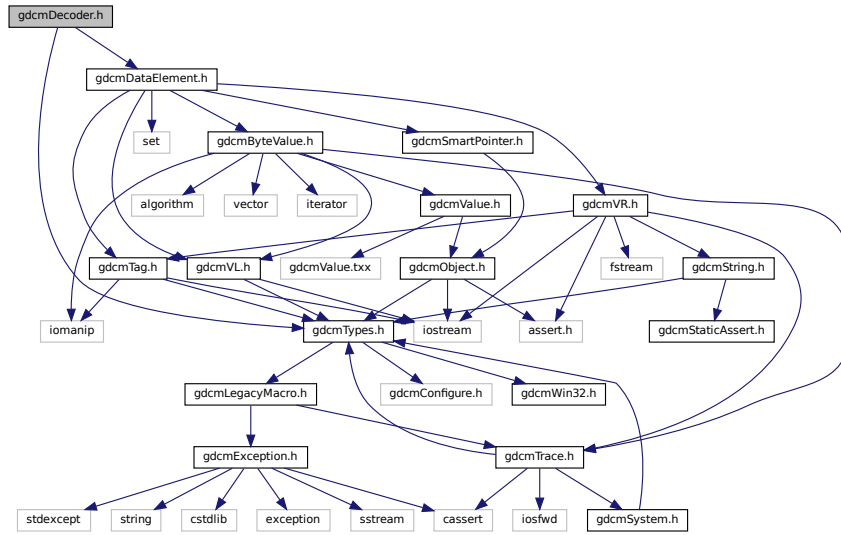

This graph shows which files directly or indirectly include this file:

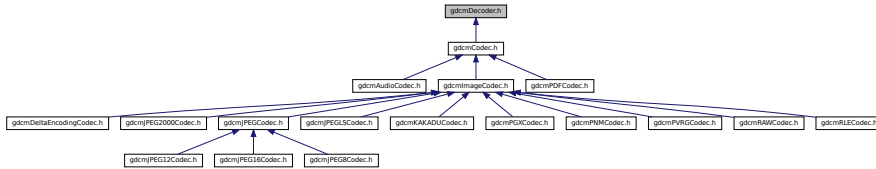

## Classes

- class `gdcm::Decoder`  
*Decoder.*

## Namespaces

- `gdcm`

## 11.59 gdcmDefinedTerms.h File Reference

```
#include "gdcmTypes.h"
```

Include dependency graph for gdcmDefinedTerms.h:

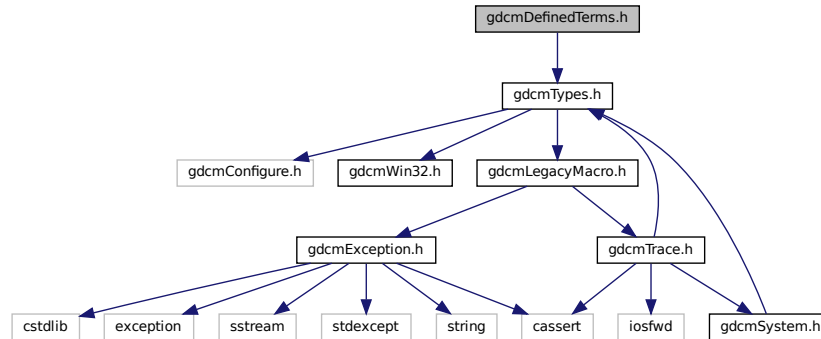

### Classes

- class [gdcm::DefinedTerms](#)

*Defined Terms are used when the specified explicit Values may be extended by implementors to include additional new Values. These new Values shall be specified in the Conformance Statement (see PS 3.2) and shall not have the same meaning as currently defined Values in this standard. A Data Element with Defined Terms that does not contain a Value equivalent to one of the Values currently specified in this standard shall not be considered to have an invalid value. Note: Interpretation Type ID (4008,0210) is an example of a Data Element having Defined Terms. It is defined to have a Value that may be one of the set of standard Values; REPORT or AMENDMENT (see PS 3.3). Because this Data Element has Defined Terms other Interpretation Type IDs may be defined by the implementor.*

### Namespaces

- [gdcm](#)

## 11.60 gdcmDeflateStream.h File Reference

```
#include "zipstreamimpl.h"
```

Include dependency graph for gdcmDeflateStream.h:

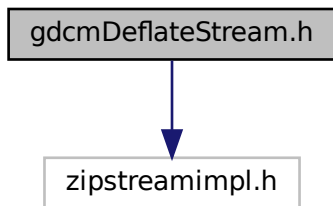

## 11.61 gdcMDefs.h File Reference

```

#include "gdcMModules.h"
#include "gdcMacros.h"
#include "gdcMIODs.h"
#include <string>
  
```

Include dependency graph for gdcMDefs.h:

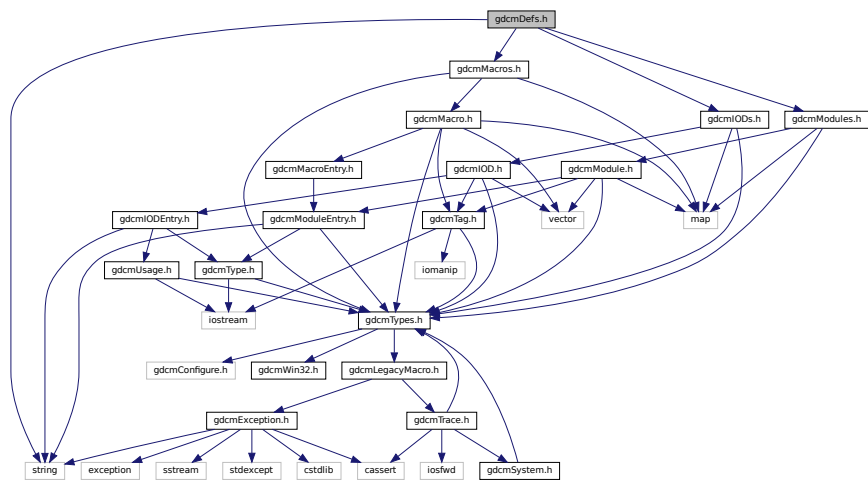





## 11.64 gdcmDICOMDIRGenerator.h File Reference

```
#include "gdcmDirectory.h"
#include "gdcmTag.h"
#include <utility>
```

Include dependency graph for gdcmDICOMDIRGenerator.h:

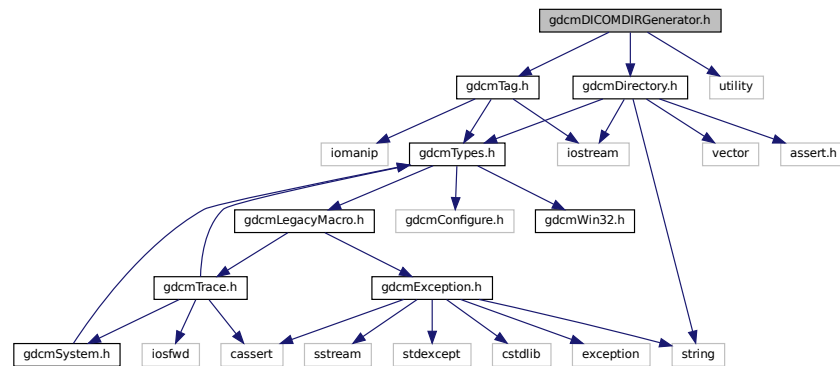

### Classes

- class [gdcm::DICOMDIRGenerator](#)  
*DICOMDIRGenerator* class.

### Namespaces

- [gdcm](#)

## 11.65 gdcmDict.h File Reference

```
#include "gdcmTypes.h"
#include "gdcmTag.h"
#include "gdcmPrivateTag.h"
#include "gdcmDictEntry.h"
#include "gdcmSystem.h"
#include <iostream>
#include <iomanip>
```



```
#include <map>
```

Include dependency graph for gdcmDict.h:

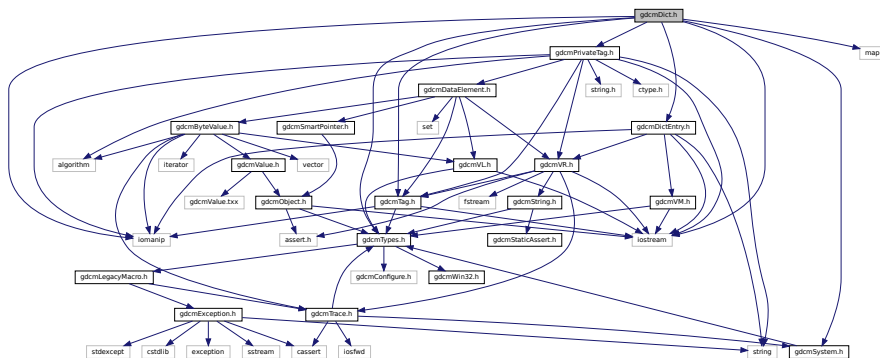

This graph shows which files directly or indirectly include this file:

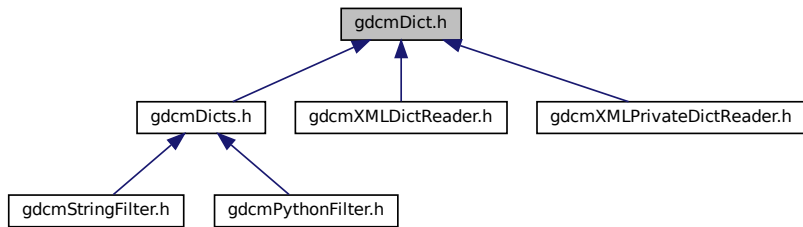

## Classes

- class `gdcm::Dict`  
Class to represent a map of *DictEntry*.
- class `gdcm::PrivateDict`  
Private *Dict*.

## Namespaces

- `gdcm`

## Functions

- `std::ostream & gdcm::operator<< (std::ostream &os, const Dict &val)`
- `std::ostream & gdcm::operator<< (std::ostream &os, const PrivateDict &val)`

## 11.66 gdcDictConverter.h File Reference

```
#include "gdcTypes.h"
#include "gdcVR.h"
#include "gdcVM.h"
#include <string>
```

Include dependency graph for gdcDictConverter.h:

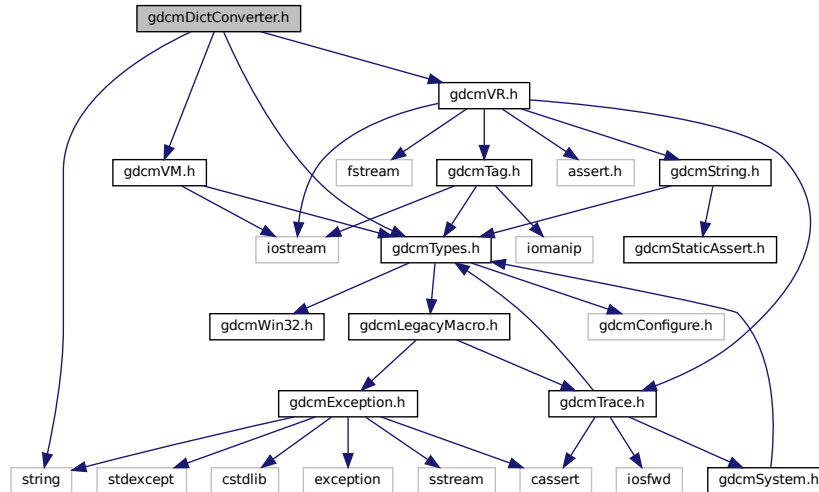

### Classes

- class [gdc::DictConverter](#)  
Class to convert a .dic file into something else:

### Namespaces

- [gdc](#)

## 11.67 gdcDictEntry.h File Reference

```
#include "gdcVR.h"
#include "gdcVM.h"
#include <string>
#include <iostream>
```

```
#include <iomanip>
```

Include dependency graph for gdcDictEntry.h:

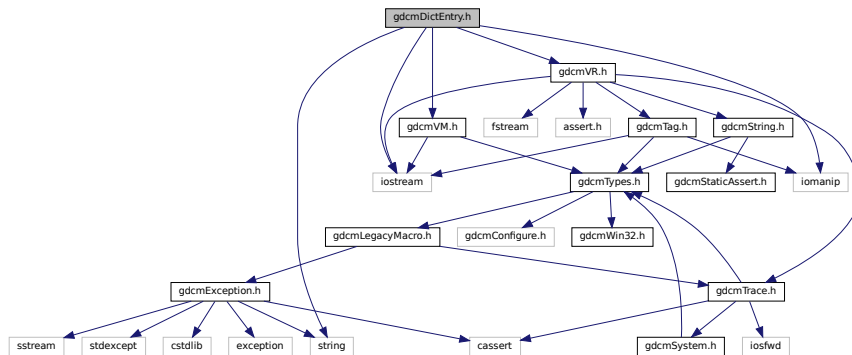

This graph shows which files directly or indirectly include this file:

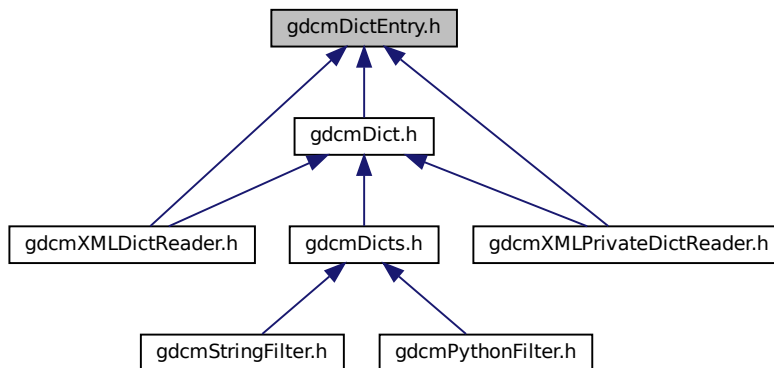

## Classes

- class [gdc::DictEntry](#)  
*Class to represent an Entry in the [Dict](#).*

## Namespaces

- [gdc](#)

## Functions

- `std::ostream & gdc::operator<< (std::ostream &os, const DictEntry &val)`

## 11.68 gdcDictPrinter.h File Reference

```
#include "gdcPrinter.h"
```

Include dependency graph for gdcDictPrinter.h:

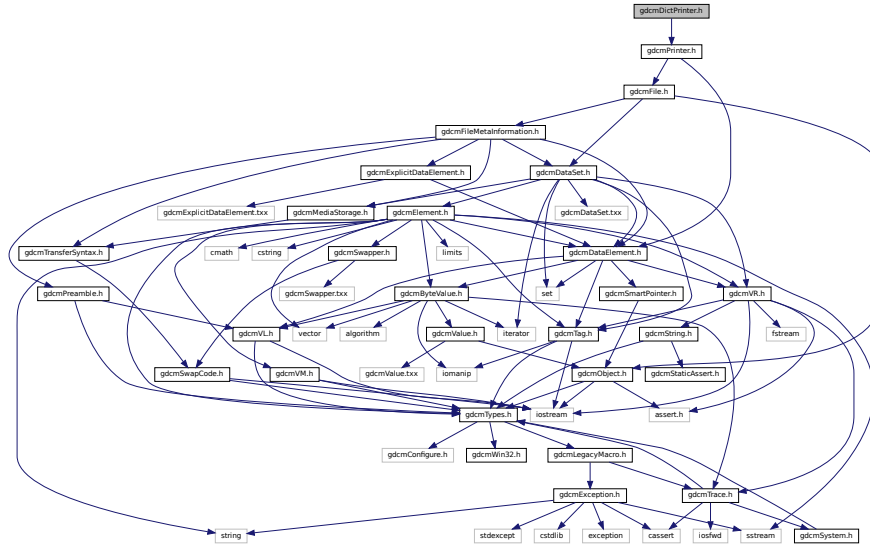

### Classes

- class [gdcm::DictPrinter](#)  
*DictPrinter* class.

### Namespaces

- [gdc](#)

## 11.69 gdcDicts.h File Reference

```
#include "gdcDict.h"
```

```
#include "gdcCSAHeaderDict.h"
```



## 11.70 gdcmdIMSE.h File Reference

```
#include "gdcmdTypes.h"
```

Include dependency graph for gdcmdIMSE.h:

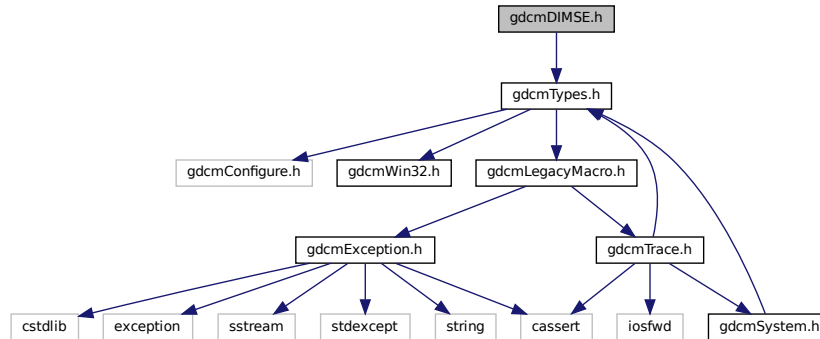

### Classes

- class [gdcmd::network::CEchoRQ](#)  
*CEchoRQ.*
- class [gdcmd::network::CEchoRSP](#)  
*CEchoRSP* this file defines the messages for the cecho action.
- class [gdcmd::network::CFind](#)
- class [gdcmd::network::DIMSE](#)  
*DIMSE.*

### Namespaces

- [gdcmd](#)
- [gdcmd::network](#)

## 11.71 gdcmdDirectionCosines.h File Reference

```
#include "gdcmdTypes.h"
```

Include dependency graph for gdcmDirectionCosines.h:

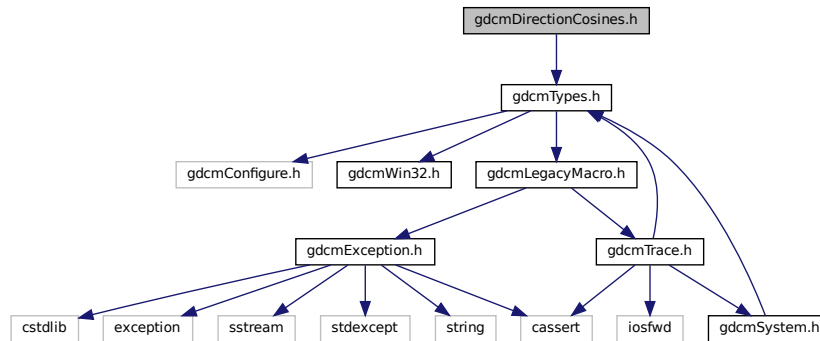

## Classes

- class [gdcm::DirectionCosines](#)  
class to handle *DirectionCosines*

## Namespaces

- [gdcm](#)

## 11.72 gdcmDirectory.h File Reference

```
#include "gdcmTypes.h"
#include <string>
#include <vector>
#include <iostream>
#include <assert.h>
```

Include dependency graph for gdcmDirectory.h:

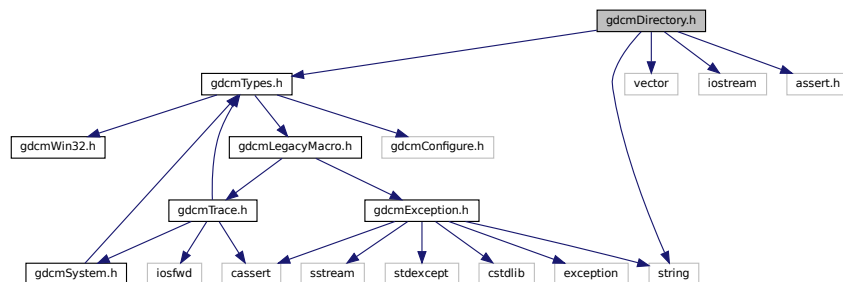

This graph shows which files directly or indirectly include this file:

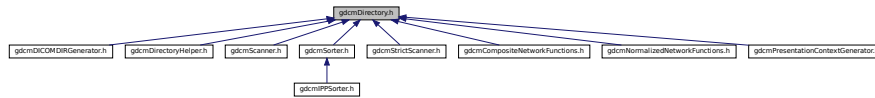

## Classes

- class [gdcmdir::Directory](#)  
Class for manipulation directories.

## Namespaces

- [gdcmdir](#)

## Functions

- std::ostream & [gdcmdir::operator<<](#) (std::ostream &os, const Directory &d)

## 11.73 gdcmdirDirectoryHelper.h File Reference

```
#include "gdcmdirDirectory.h"
#include "gdcmdirDataSet.h"
Include dependency graph for gdcmdirDirectoryHelper.h:
```

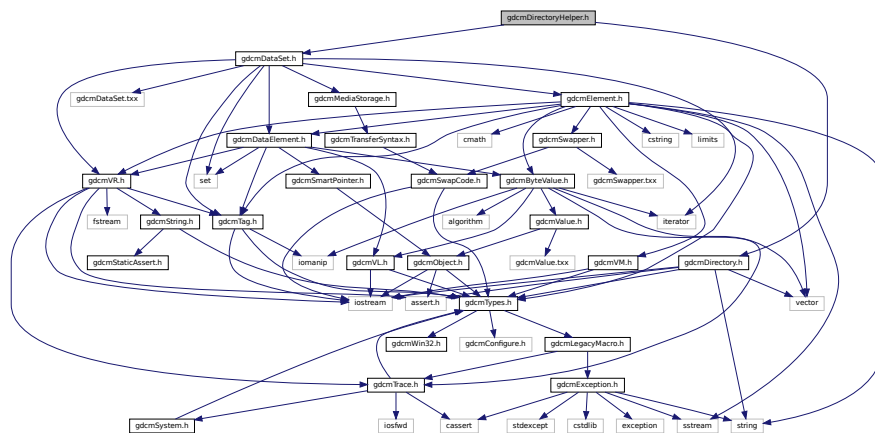



## Classes

- class [gdcm::DirectoryHelper](#)  
*DirectoryHelper.*

## Namespaces

- [gdcm](#)

## 11.74 gdcmDummyValueGenerator.h File Reference

```
#include "gdcmTypes.h"
```

Include dependency graph for gdcmDummyValueGenerator.h:

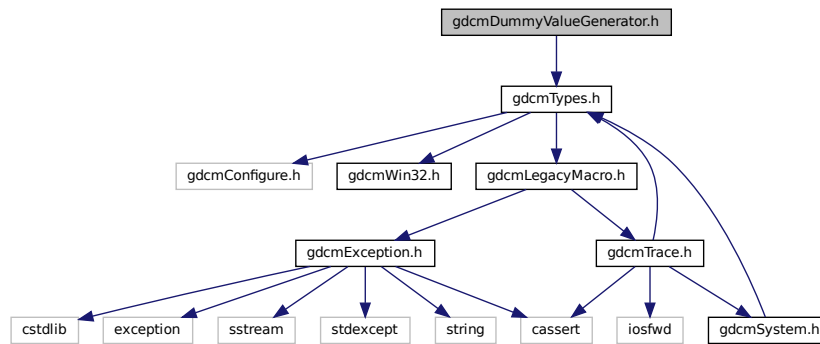

## Classes

- class [gdcm::DummyValueGenerator](#)  
*Class for generating dummy value.*

## Namespaces

- [gdcm](#)

## 11.75 gdcuDumper.h File Reference

```
#include "gdcuPrinter.h"
```

Include dependency graph for gdcuDumper.h:

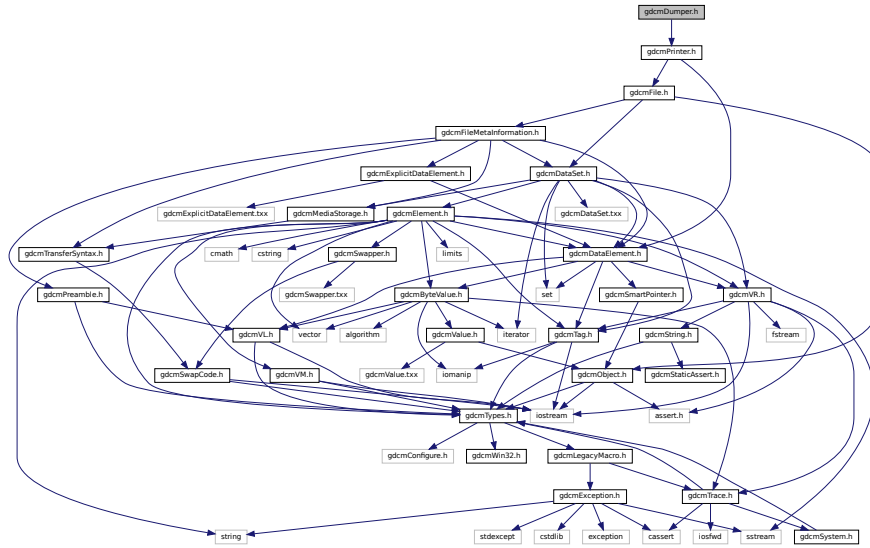

### Classes

- class [gdcu::Dumper](#)  
*Codec class.*

### Namespaces

- [gdcu](#)

## 11.76 gdcuElement.h File Reference

```
#include "gdcuTypes.h"
#include "gdcuVR.h"
#include "gdcuTag.h"
#include "gdcuVM.h"
#include "gdcuByteValue.h"
#include "gdcuDataElement.h"
#include "gdcuSwapper.h"
#include <string>
#include <vector>
#include <sstream>
#include <limits>
```

```
#include <cmath>
#include <cstring>
```

Include dependency graph for gdcmElement.h:

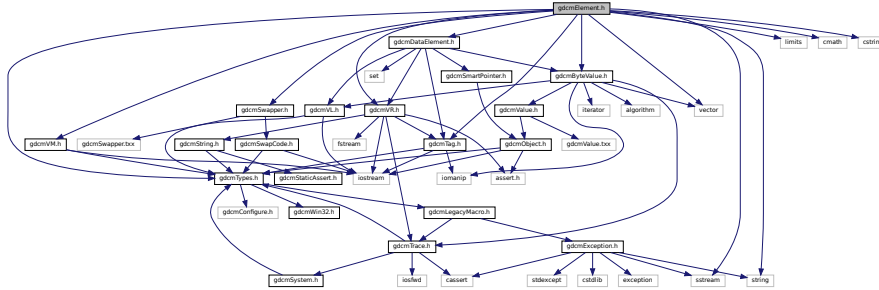

This graph shows which files directly or indirectly include this file:

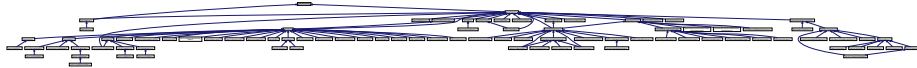

## Classes

- class [gdcm::Element< TVR, TVM >](#)
- class [gdcm::Element< TVR, VM::VM1\\_2 >](#)
- class [gdcm::Element< TVR, VM::VM1\\_n >](#)
- class [gdcm::Element< TVR, VM::VM2\\_2n >](#)
- class [gdcm::Element< TVR, VM::VM2\\_n >](#)
- class [gdcm::Element< TVR, VM::VM3\\_3n >](#)
- class [gdcm::Element< TVR, VM::VM3\\_4 >](#)
- class [gdcm::Element< TVR, VM::VM3\\_n >](#)
- class [gdcm::Element< VR::AS, VM::VM5 >](#)
- class [gdcm::Element< VR::OB, VM::VM1 >](#)
- class [gdcm::Element< VR::OW, VM::VM1 >](#)
- class [gdcm::ElementDisableCombinations< TVR, TVM >](#)

*A class which is used to produce compile errors for an invalid combination of template parameters.*

- class [gdcm::ElementDisableCombinations< VR::OB, VM::VM1\\_n >](#)
- class [gdcm::ElementDisableCombinations< VR::OW, VM::VM1\\_n >](#)
- class [gdcm::EncodingImplementation< VR::VRASCII >](#)
- class [gdcm::EncodingImplementation< VR::VRBINARY >](#)
- struct [gdcm::ignore\\_char](#)

## Namespaces

- [gdcm](#)

## Functions

- static int [gdcM::add1](#) (char \*buf, int n)
- ignore\_char const [gdcM::backslash](#) ('\')
- static void [gdcM::clean](#) (char \*mant)
- static int [gdcM::doround](#) (char \*buf, unsigned int n)
- std::istream & [gdcM::operator>>](#) (std::istream &in, ignore\_char const &ic)
- static int [gdcM::roundat](#) (char \*buf, unsigned int i, int iexp)
- template<typename Float >  
static void [gdcM::x16printf](#) (char \*buf, int size, Float f)

## 11.77 gdcMEmptyMaskGenerator.h File Reference

```
#include "gdcMSubject.h"
```

Include dependency graph for gdcMEmptyMaskGenerator.h:

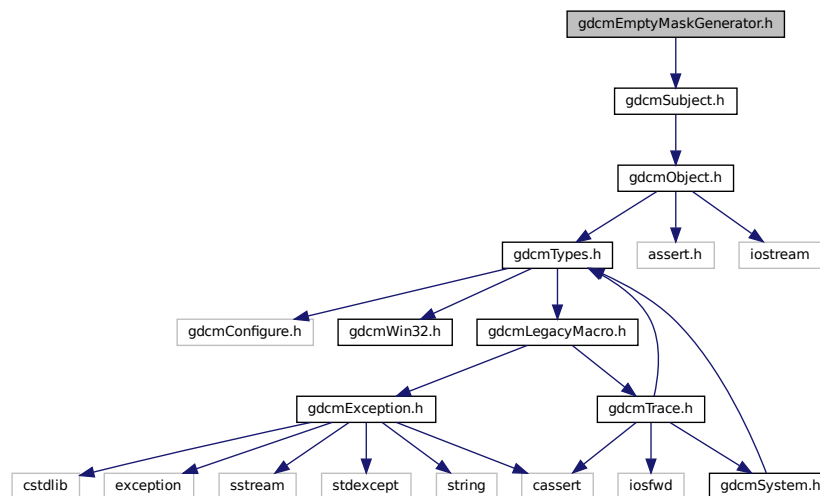

## Classes

- class [gdcM::EmptyMaskGenerator](#)

*EmptyMaskGenerator* Main class to generate a *Empty Mask Series* from an input *Series*. This class takes an input folder and generates a series of DICOM files in the specified output directory. This class handles multiples DICOM *Series* within the same input directory.

## Namespaces

- [gdcM](#)

## 11.78 gdcmEncapsulatedDocument.h File Reference

```
#include "gdcmFile.h"
```

Include dependency graph for gdcmEncapsulatedDocument.h:

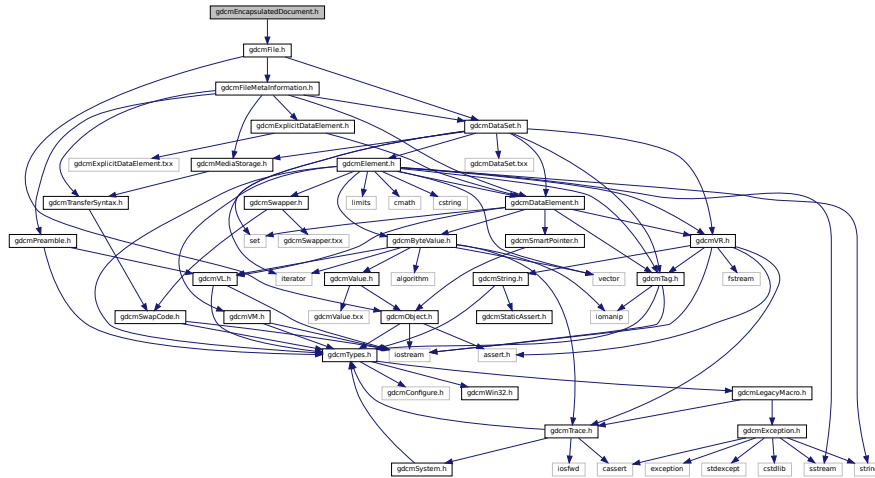

### Classes

- class [gdcm::EncapsulatedDocument](#)  
*EncapsulatedDocument.*

### Namespaces

- [gdcm](#)

## 11.79 gdcmEnumeratedValues.h File Reference

```
#include "gdcmTypes.h"
```

Include dependency graph for gdcmEnumeratedValues.h:

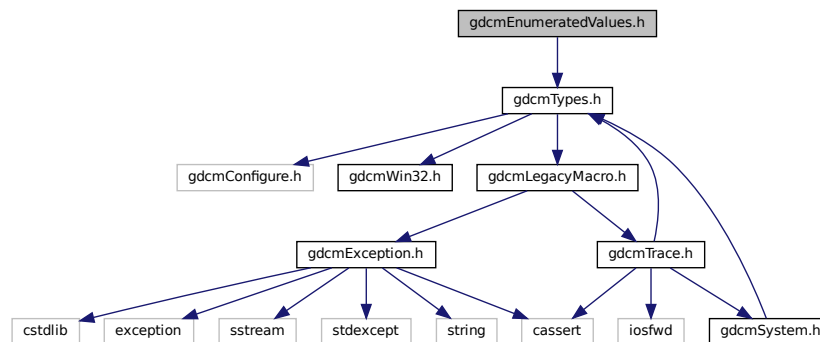

## Classes

- class [gdcm::EnumeratedValues](#)

*Element.* A Data *Element* with Enumerated Values that does not have a *Value* equivalent to one of the Values specified in this standard has an invalid value within the scope of a specific Information Object/SOP Class definition. Note:

## Namespaces

- [gdcm](#)

## 11.80 gdcmEquipmentManufacturer.h File Reference

```
#include "gdcmTypes.h"
```

Include dependency graph for gdcmEquipmentManufacturer.h:

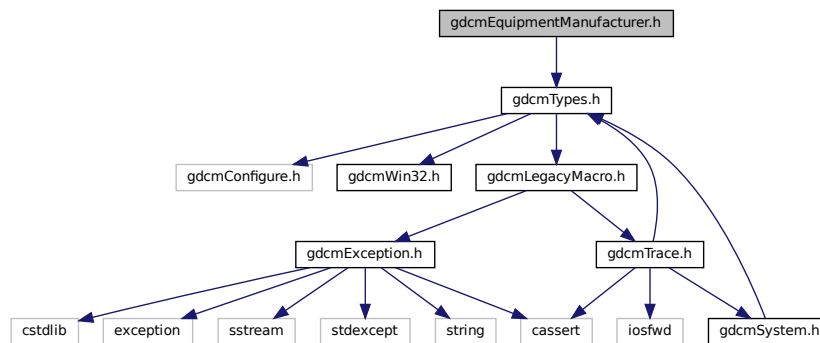

## Classes

- class [gdcm::EquipmentManufacturer](#)

## Namespaces

- [gdcm](#)

## 11.81 gdcmEvent.h File Reference

```
#include "gdcmTypes.h"
```

Include dependency graph for gdcmEvent.h:

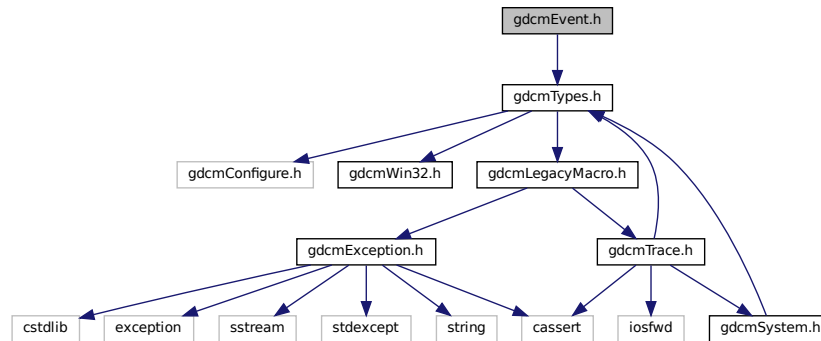

This graph shows which files directly or indirectly include this file:

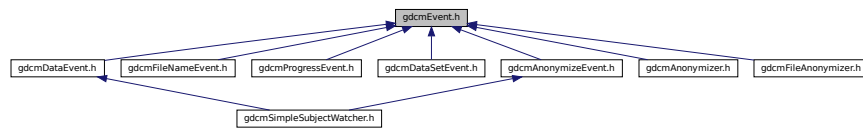

### Classes

- class [gdcm::AbortEvent](#)
- class [gdcm::AnyEvent](#)
- class [gdcm::EndEvent](#)
- class [gdcm::Event](#)  
*superclass for callback/observer methods*
- class [gdcm::ExitEvent](#)
- class [gdcm::InitializeEvent](#)
- class [gdcm::IterationEvent](#)
- class [gdcm::ModifiedEvent](#)
- class [gdcm::NoEvent](#)
- class [gdcm::StartEvent](#)
- class [gdcm::UserEvent](#)

### Namespaces

- [gdcm](#)

## Macros

- #define `gdcmEventMacro`(classname, super)

## Functions

- `std::ostream & gdcm::operator<<` (std::ostream &os, Event &e)  
*Generic inserter operator for `Event` and its subclasses.*

### 11.81.1 Macro Definition Documentation

#### 11.81.1.1 `gdcmEventMacro`

```
#define gdcmEventMacro(
    classname,
    super )
```

#### Value:

```
\
class classname : public super { \
public: \
    typedef classname Self; \
    typedef super Superclass; \
    classname() {} \
    virtual ~classname() override = default; \
    virtual const char * GetEventName() const override { return #classname; } \
    virtual bool CheckEvent(const ::gdcm::Event* e) const override \
    { return dynamic_cast<const Self*>(e) ? true : false; } \
    virtual ::gdcm::Event* MakeObject() const override \
    { return new Self; } \
    classname(const Self&s) : super(s){}; \
private: \
    void operator=(const Self&); \
}
```

### 11.82 `gdcmException.h` File Reference

```
#include <cassert>
#include <cstdlib>
#include <exception>
#include <sstream>
#include <stdexcept>
```



```
#include <string>
```

Include dependency graph for gdcmException.h:

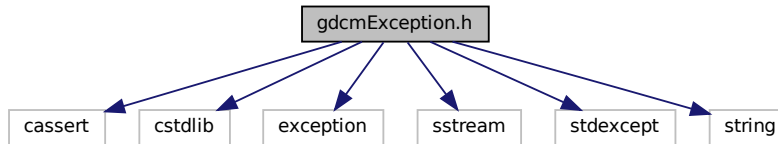

This graph shows which files directly or indirectly include this file:



## Classes

- class [gdcm::Exception](#)  
*Exception.*

## Namespaces

- [gdcm](#)

## 11.83 gdcmExplicitDataElement.h File Reference

```
#include "gdcmDataElement.h"
```

```
#include "gdcmExplicitDataElement.txx"
```

Include dependency graph for gdcmExplicitDataElement.h:

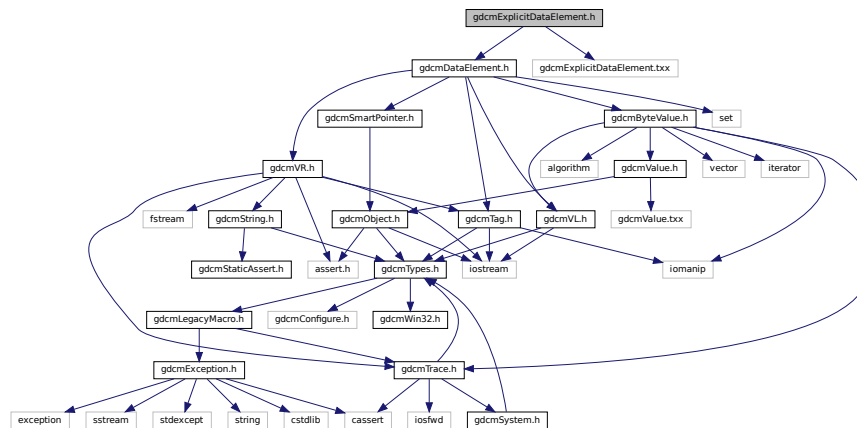

This graph shows which files directly or indirectly include this file:

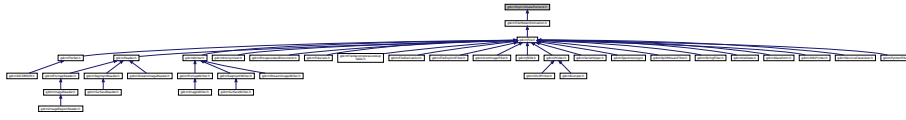

## Classes

- class [gdcm::ExplicitDataElement](#)  
Class to read/write a *DataElement* as *Explicit Data Element*.

## Namespaces

- [gdcm](#)

## 11.84 gdcmExplicitImplicitDataElement.h File Reference

```
#include "gdcmDataElement.h"
#include "gdcmExplicitImplicitDataElement.txx"
Include dependency graph for gdcmExplicitImplicitDataElement.h:
```

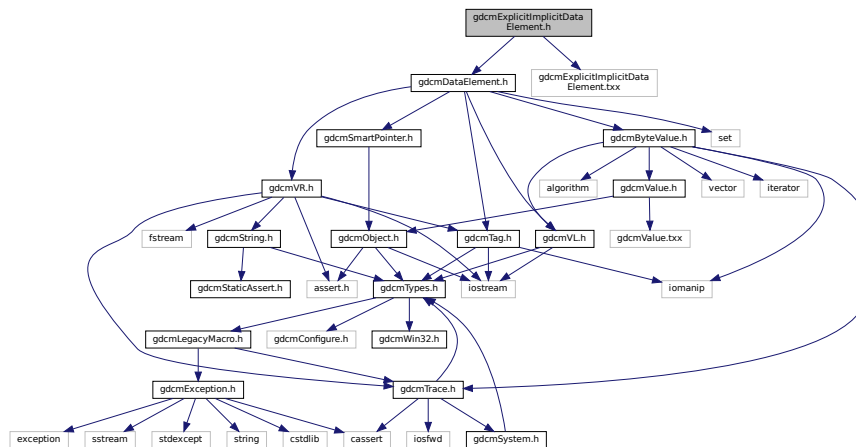

## Classes

- class [gdcm::ExplicitImplicitDataElement](#)  
Class to read/write a *DataElement* as *ExplicitImplicit Data Element*.

## Namespaces

- [gdcM](#)

## 11.85 gdcMFiducials.h File Reference

```
#include "gdcMFile.h"
```

Include dependency graph for gdcMFiducials.h:

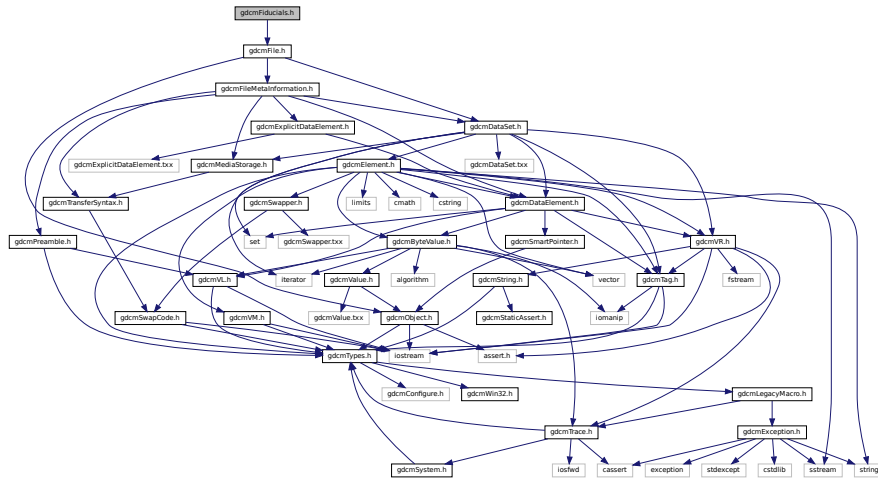

## Classes

- class [gdcM::Fiducials](#)  
*Fiducials.*

## Namespaces

- [gdcM](#)

## 11.86 gdcMFile.h File Reference

```
#include "gdcMObject.h"
```

```
#include "gdcMDataSet.h"
```

```
#include "gdcmFileMetaInformation.h"
Include dependency graph for gdcmFile.h:
```

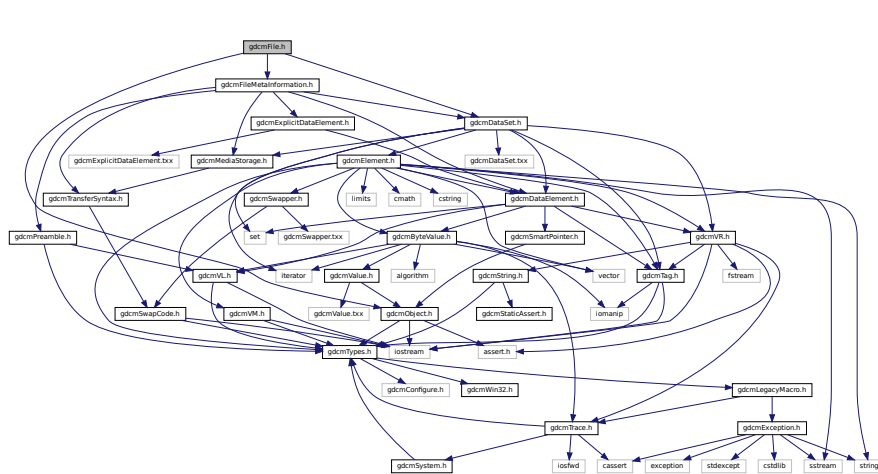

This graph shows which files directly or indirectly include this file:

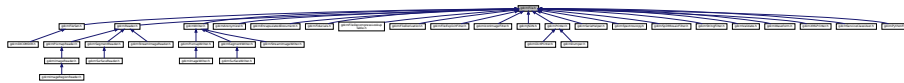

## Classes

- class [gdcm::File](#)  
a DICOM File

## Namespaces

- [gdcm](#)

## Functions

- `std::ostream & gdcm::operator<< (std::ostream &os, const File &val)`

## 11.87 gdcmFileAnonymizer.h File Reference

```
#include "gdcmSubject.h"
#include "gdcmEvent.h"
#include "gdcmTag.h"
#include "gdcmVL.h"
```

Include dependency graph for gdcmFileAnonymizer.h:

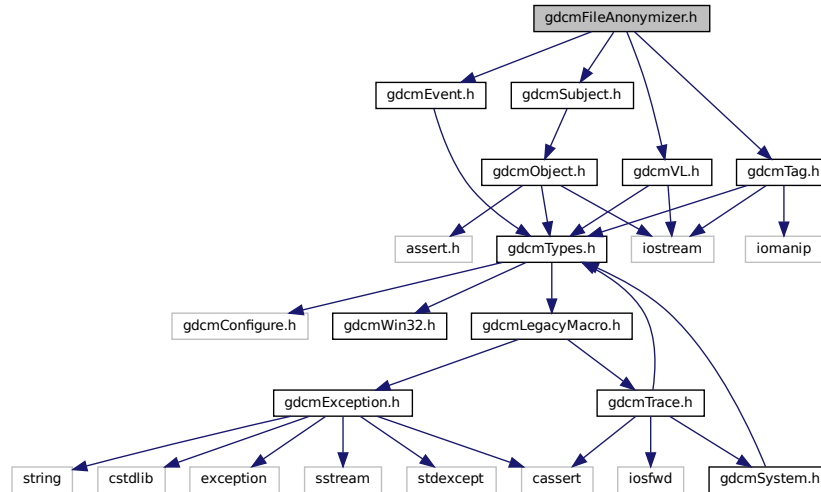

### Classes

- class [gdcm::FileAnonymizer](#)  
*FileAnonymizer.*

### Namespaces

- [gdcm](#)

## 11.88 gdcmFileChangeTransferSyntax.h File Reference

```
#include "gdcmSubject.h"
#include "gdcmSmartPointer.h"
```

Include dependency graph for `gdcmFileChangeTransferSyntax.h`:

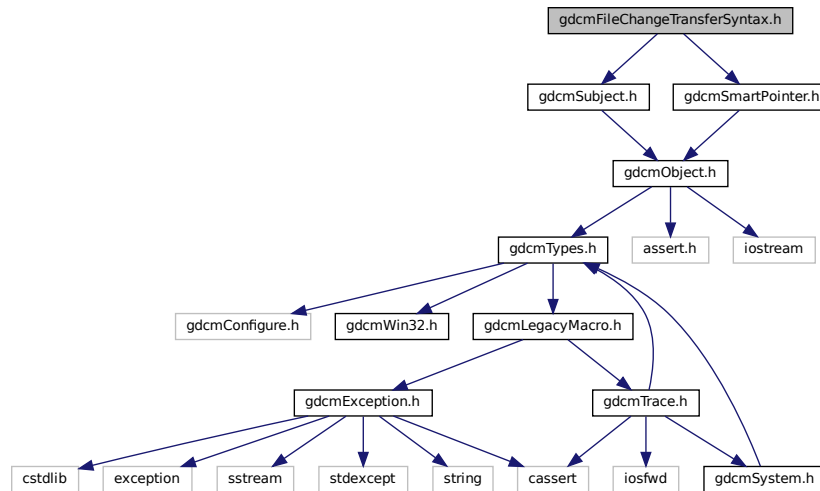

## Classes

- class `gdcm::FileChangeTransferSyntax`  
*FileChangeTransferSyntax.*

## Namespaces

- `gdcm`

## 11.89 `gdcmFileDecompressLookupTable.h` File Reference

```

#include "gdcmSubject.h"
#include "gdcmFile.h"
#include "gdcmPixmap.h"

```







## 11.92 gdcmFileMetaInformation.h File Reference

```
#include "gdcmPreamble.h"
#include "gdcmDataSet.h"
#include "gdcmDataElement.h"
#include "gdcmMediaStorage.h"
#include "gdcmTransferSyntax.h"
#include "gdcmExplicitDataElement.h"
```

Include dependency graph for gdcmFileMetaInformation.h:

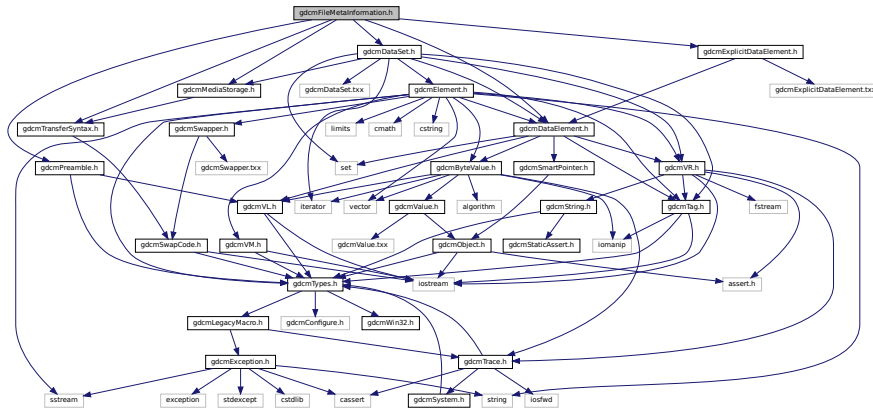

This graph shows which files directly or indirectly include this file:

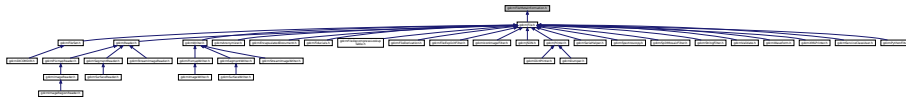

### Classes

- class [gdcm::FileMetaInformation](#)  
Class to represent a *File Meta Information*.

### Namespaces

- [gdcm](#)

### Functions

- `std::ostream & gdcm::operator<< (std::ostream &os, const FileMetaInformation &val)`

## 11.93 gdcmFilename.h File Reference

```
#include "gdcmTypes.h"
```

```
#include <string>
```

Include dependency graph for gdcmFilename.h:

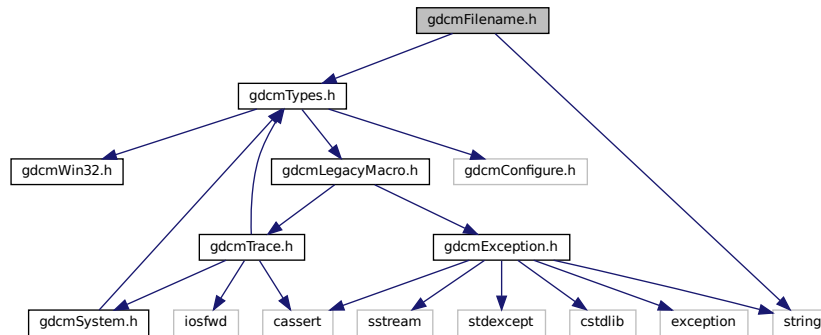

### Classes

- class [gdcm::Filename](#)  
*Class to manipulate file name's.*

### Namespaces

- [gdcm](#)

## 11.94 gdcmFileNameEvent.h File Reference

```
#include "gdcmEvent.h"
```

```
#include "gdcmTag.h"
```

Include dependency graph for gdcMFileNameEvent.h:

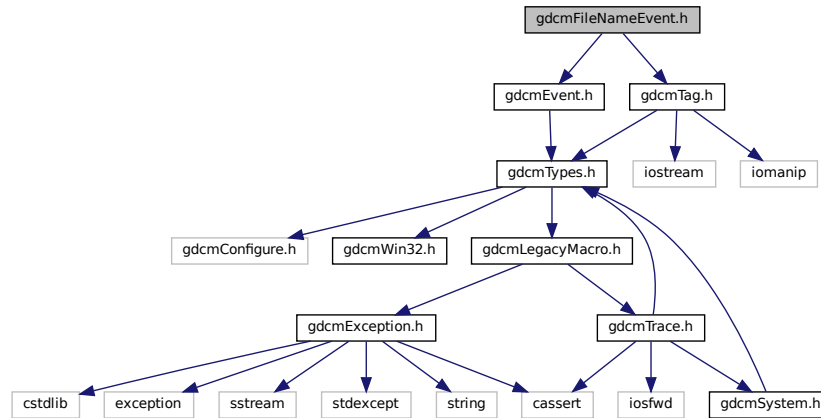

## Classes

- class [gdcM::FileNameEvent](#)  
*FileNameEvent.*

## Namespaces

- [gdcM](#)

## 11.95 gdcMFilenameGenerator.h File Reference

```
#include "gdcMTypes.h"
#include <string>
#include <vector>
```

Include dependency graph for gdcMFilenameGenerator.h:

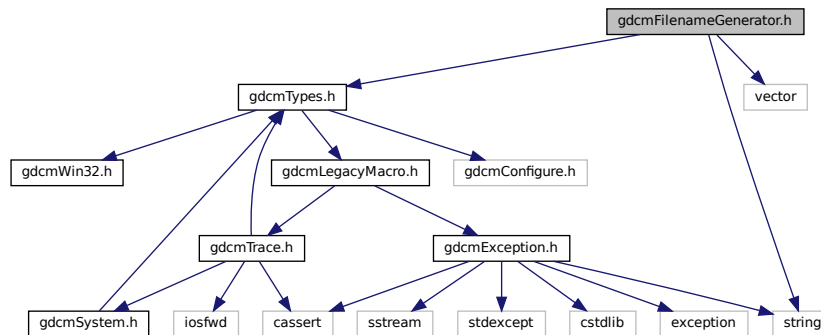



## Classes

- class [gdcm::FileSet](#)

## Namespaces

- [gdcm](#)

## Functions

- `std::ostream & gdcm::operator<< (std::ostream &os, const FileSet &f)`

## 11.97 gdcmFileStreamer.h File Reference

```
#include "gdcmSubject.h"
```

```
#include "gdcmSmartPointer.h"
```

Include dependency graph for gdcmFileStreamer.h:

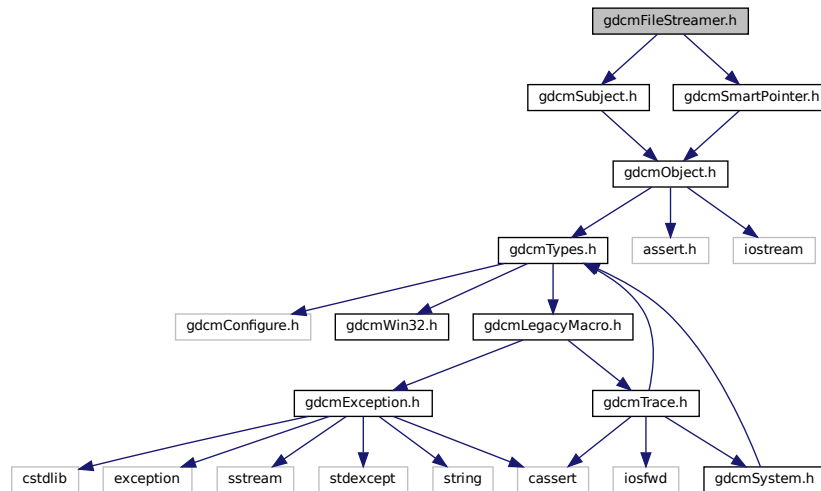

## Classes

- class [gdcm::FileStreamer](#)  
*FileStreamer.*

## Namespaces

- [gdcm](#)

## 11.98 gdcmFindPatientRootQuery.h File Reference

```
#include "gdcmBaseRootQuery.h"
```

Include dependency graph for gdcmFindPatientRootQuery.h:

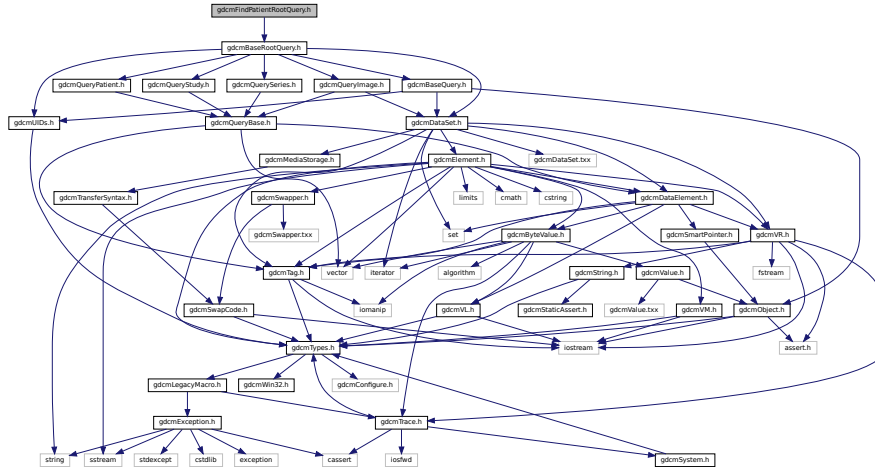

This graph shows which files directly or indirectly include this file:

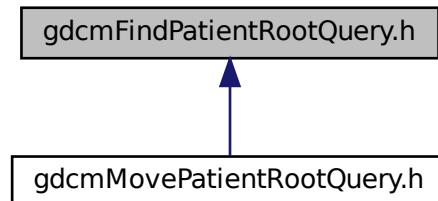

### Classes

- class [gdcm::FindPatientRootQuery](#)  
*PatientRootQuery.*

### Namespaces

- [gdcm](#)

## 11.99 gdcmFindStudyRootQuery.h File Reference

```
#include "gdcmBaseRootQuery.h"
```

Include dependency graph for gdcmFindStudyRootQuery.h:

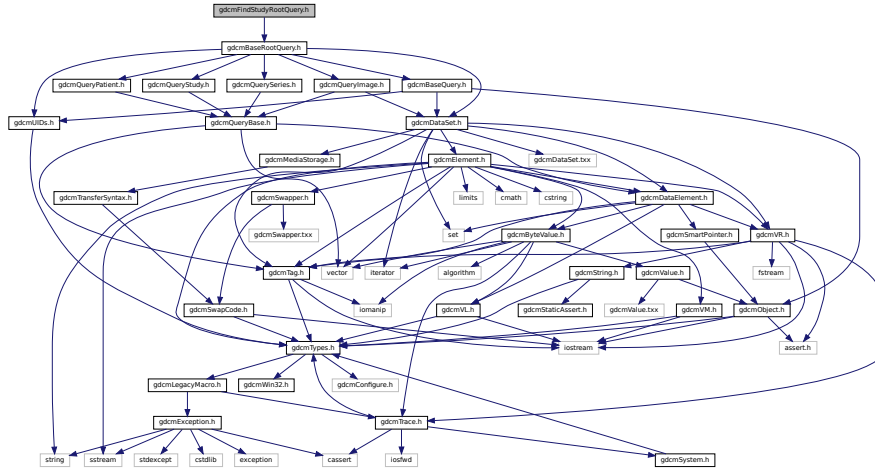

### Classes

- class [gdcm::FindStudyRootQuery](#)  
*FindStudyRootQuery.*

### Namespaces

- [gdcm](#)

## 11.100 gdcmFragment.h File Reference

```
#include "gdcmDataElement.h"
```

```
#include "gdcmByteValue.h"
```

```
#include "gdcmSmartPointer.h"
```

```
#include "gdcmParseException.h"
Include dependency graph for gdcmFragment.h:
```

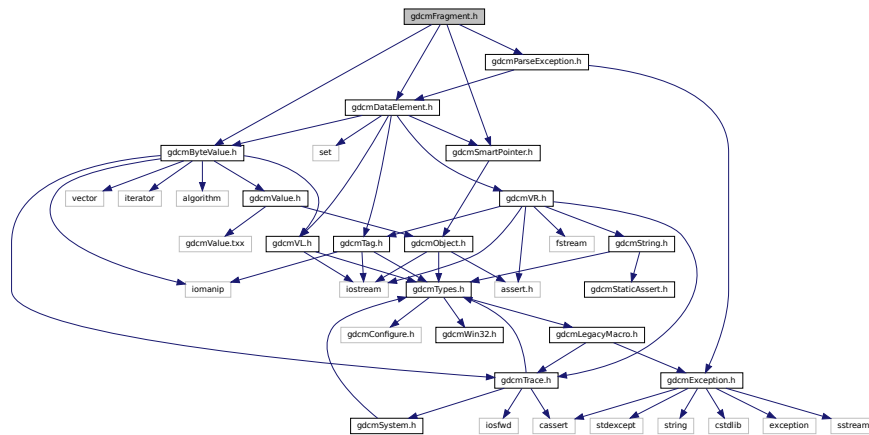

This graph shows which files directly or indirectly include this file:

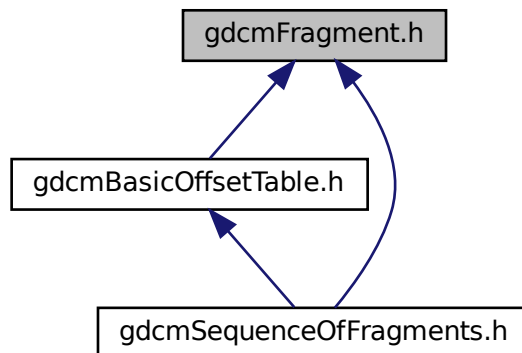

## Classes

- class [gdcm::Fragment](#)  
Class to represent a *Fragment*.

## Namespaces

- [gdcm](#)



## Functions

- `std::ostream & gdcm::operator<<` (`std::ostream &os, const Fragment &val`)

## 11.101 gdcmGlobal.h File Reference

```
#include "gdcmTypes.h"
```

Include dependency graph for `gdcmGlobal.h`:

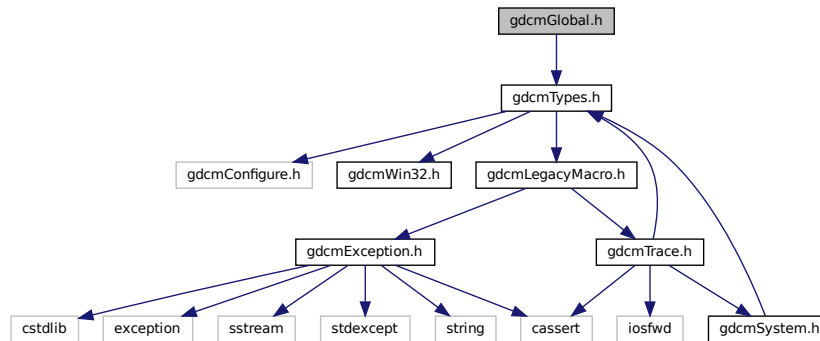

## Classes

- class `gdcm::Global`  
*Global.*

## Namespaces

- `gdcm`

## Functions

- `std::ostream & gdcm::operator<<` (`std::ostream &os, const Global &g`)

## Variables

- static Global `gdcm::GlobalInstance`

## 11.102 gdcmGroupDict.h File Reference

```
#include "gdcmTypes.h"
#include <assert.h>
#include <vector>
#include <string>
#include <iostream>
#include <iomanip>
```

Include dependency graph for gdcmGroupDict.h:

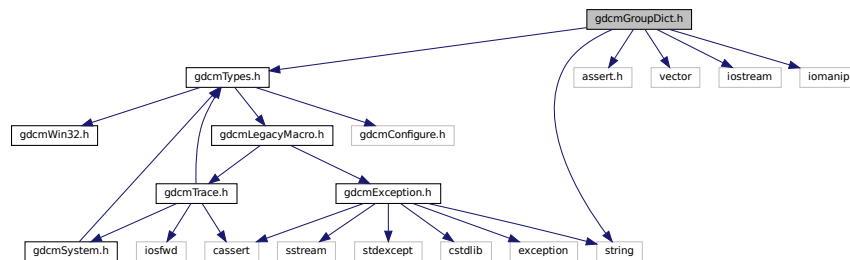

### Classes

- class [gdcm::GroupDict](#)  
*Class to represent the mapping from group number to its abbreviation and name.*

### Namespaces

- [gdcm](#)

### Functions

- `std::ostream & gdcm::operator<< (std::ostream &_os, const GroupDict &_val)`

## 11.103 gdcmIconImage.h File Reference

```
#include "gdcmBitmap.h"
```

Include dependency graph for gdcmlconImage.h:

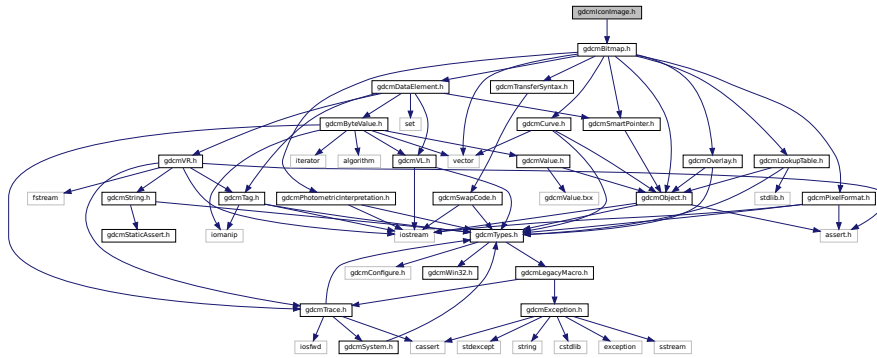

This graph shows which files directly or indirectly include this file:

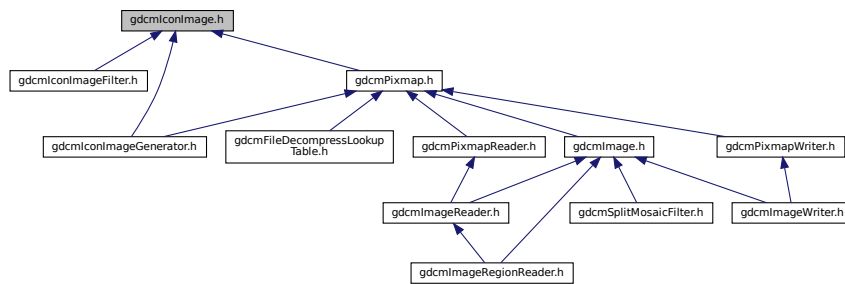

### Namespaces

- [gdcml](#)

### Typedefs

- typedef Bitmap [gdcml::IconImage](#)

## 11.104 gdcmlconImageFilter.h File Reference

```
#include "gdcmlFile.h"
#include "gdcmlconImage.h"
```





## Classes

- class [gdcm::Image](#)  
*Image.*

## Namespaces

- [gdcm](#)

## 11.107 gdcmImageApplyLookupTable.h File Reference

```
#include "gdcmImageToImageFilter.h"
```

Include dependency graph for gdcmImageApplyLookupTable.h:

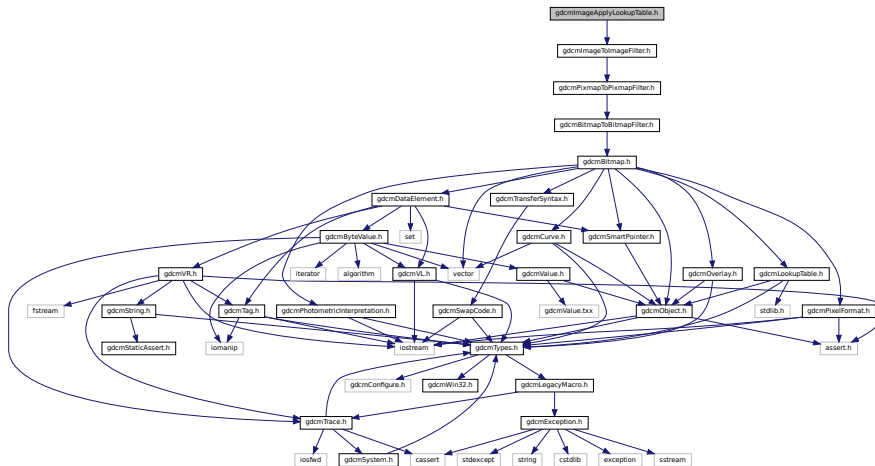

## Classes

- class [gdcm::ImageApplyLookupTable](#)  
*ImageApplyLookupTable class.*

## Namespaces

- [gdcm](#)



## 11.109 gdcmImageChangePlanarConfiguration.h File Reference

```
#include "gdcmImageToImageFilter.h"
```

Include dependency graph for gdcmImageChangePlanarConfiguration.h:

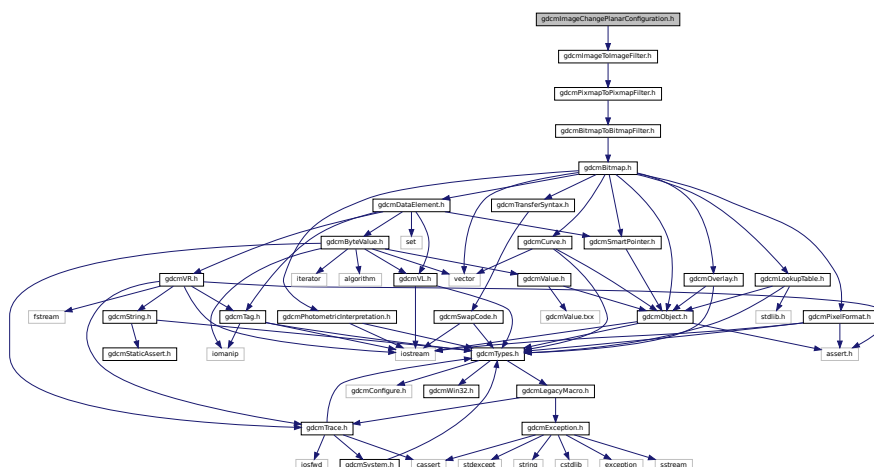

### Classes

- class `gdcm::ImageChangePlanarConfiguration`  
*ImageChangePlanarConfiguration* class.

### Namespaces

- `gdcm`

## 11.110 gdcmImageChangeTransferSyntax.h File Reference

```
#include "gdcmImageToImageFilter.h"
```

```
#include "gdcmTransferSyntax.h"
```



Include dependency graph for gdcmImageChangeTransferSyntax.h:

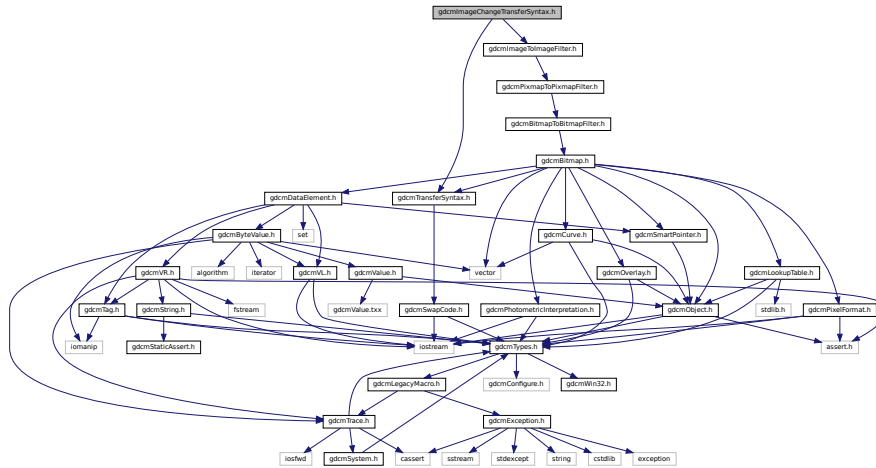

## Classes

- class [gdcm::ImageChangeTransferSyntax](#)  
*ImageChangeTransferSyntax* class.

## Namespaces

- [gdcm](#)

## 11.111 gdcmImageCodec.h File Reference

```
#include "gdcmCodec.h"
#include "gdcmPhotometricInterpretation.h"
#include "gdcmLookupTable.h"
#include "gdcmSmartPointer.h"
#include "gdcmPixelFormat.h"
```

Include dependency graph for `gdcmImageCodec.h`:

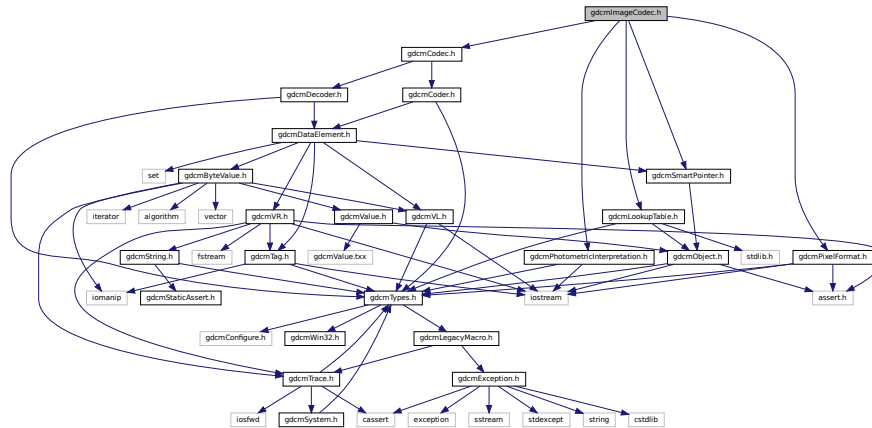

This graph shows which files directly or indirectly include this file:



## Classes

- class `gdcm::ImageCodec`  
*ImageCodec.*

## Namespaces

- `gdcm`

## 11.112 gdcmImageConverter.h File Reference

```
#include "gdcmTypes.h"
```



## Classes

- class [gdcm::ImageFragmentSplitter](#)  
*ImageFragmentSplitter* class.

## Namespaces

- [gdcm](#)

## 11.114 gdcmImageHelper.h File Reference

```
#include "gdcmTypes.h"
#include "gdcmTag.h"
#include <vector>
#include "gdcmPixelFormat.h"
#include "gdcmPhotometricInterpretation.h"
#include "gdcmSmartPointer.h"
#include "gdcmLookupTable.h"
#include "gdcmLookupTable.h"
```

Include dependency graph for gdcmImageHelper.h:

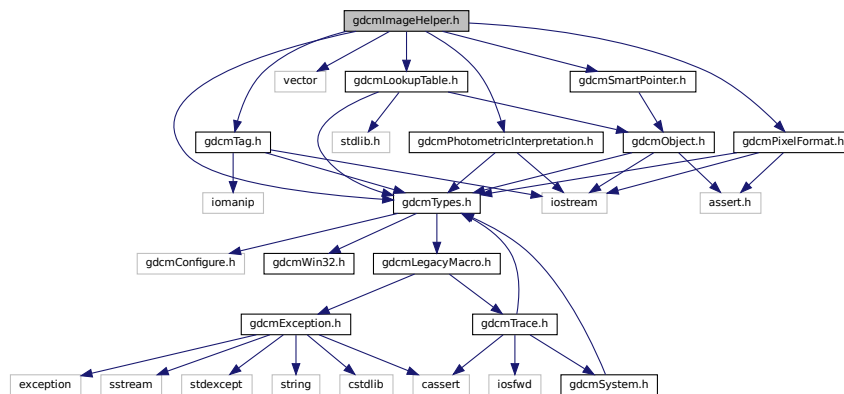

## Classes

- class [gdcm::ImageHelper](#)  
*ImageHelper* (internal class, not intended for user level)
- struct [gdcm::RealWorldValueMappingContent](#)

## Namespaces

- [gdcm](#)

## 11.115 gdcmImageReader.h File Reference

```
#include "gdcmPixmapReader.h"
#include "gdcmImage.h"
Include dependency graph for gdcmImageReader.h:
```

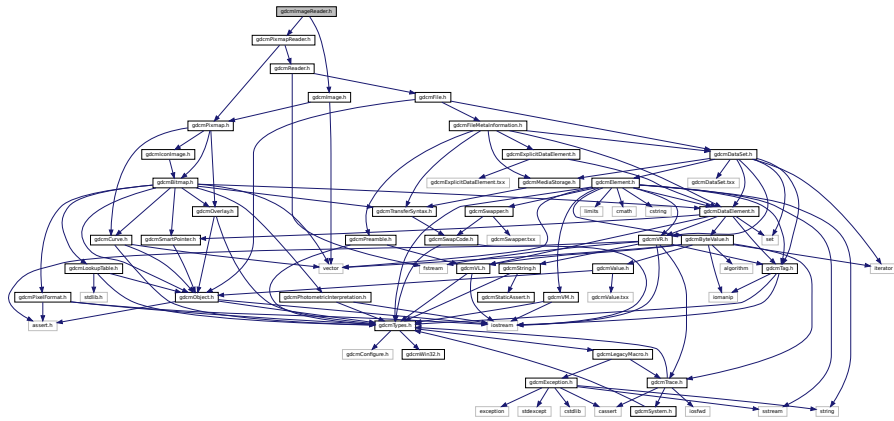

This graph shows which files directly or indirectly include this file:

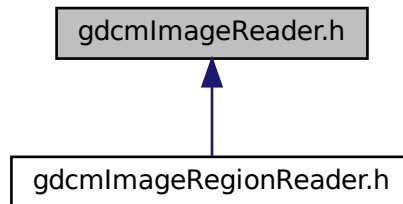

### Classes

- class [gdcm::ImageReader](#)  
*ImageReader.*

### Namespaces

- [gdcm](#)

## 11.116 gdcmImageRegionReader.h File Reference

```
#include "gdcmImageReader.h"
#include "gdcmImage.h"
#include "gdcmRegion.h"
```

Include dependency graph for gdcmImageRegionReader.h:

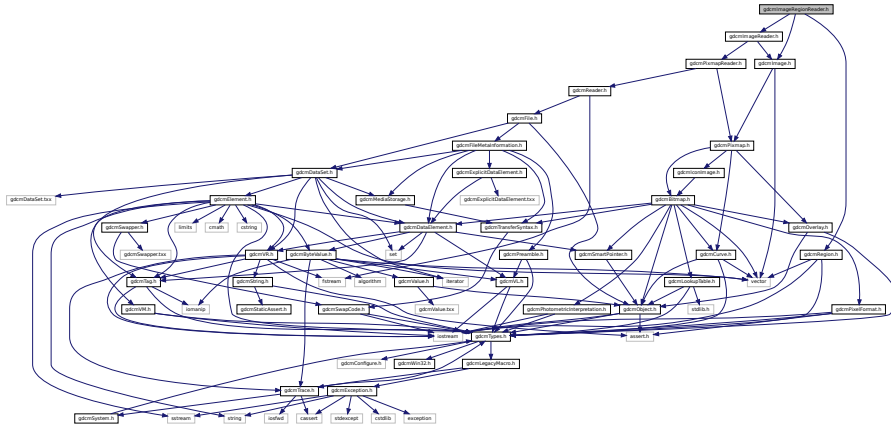

### Classes

- class [gdcm::ImageRegionReader](#)  
*ImageRegionReader.*

### Namespaces

- [gdcm](#)

## 11.117 gdcmImageToImageFilter.h File Reference

```
#include "gdcmPixmapToPixmapFilter.h"
```

Include dependency graph for gdcmImageToImageFilter.h:

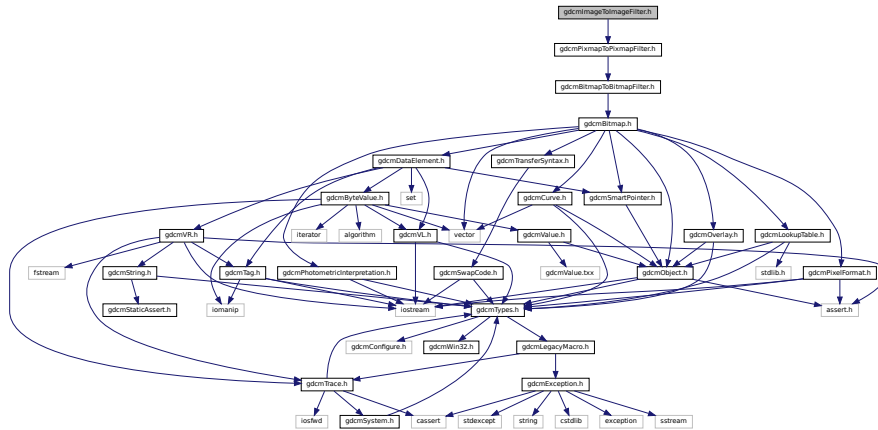

This graph shows which files directly or indirectly include this file:

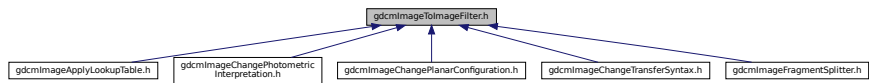

### Classes

- class [gdcm::ImageToImageFilter](#)  
*ImageToImageFilter* class.

### Namespaces

- [gdcm](#)

## 11.118 gdcmImageWriter.h File Reference

```
#include "gdcmPImageWriter.h"
#include "gdcmImage.h"
```





This graph shows which files directly or indirectly include this file:

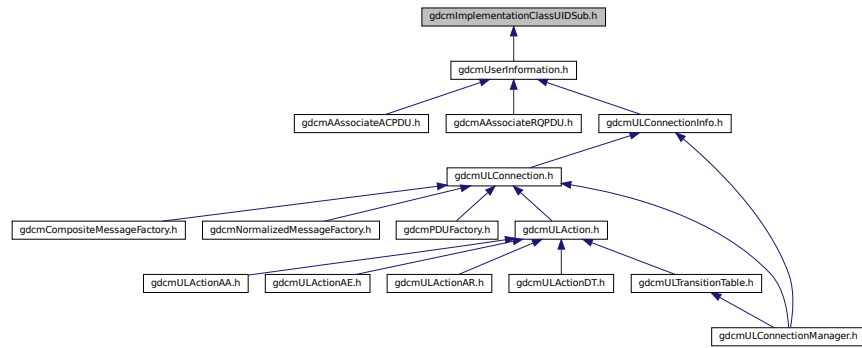

## Classes

- class [gdcm::network::ImplementationClassUIDSub](#)  
*ImplementationClassUIDSub.*

## Namespaces

- [gdcm](#)
- [gdcm::network](#)

## 11.120 gdcmImplementationUIDSub.h File Reference

```
#include "gdcmTypes.h"
```

Include dependency graph for gdcmImplementationUIDSub.h:

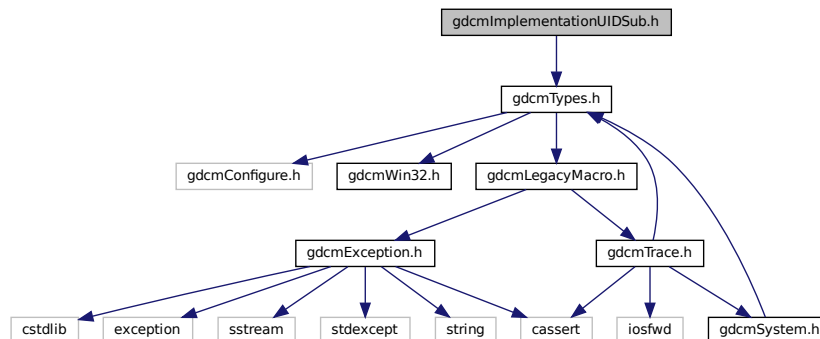

## Classes

- class [gdcmm::network::ImplementationUIDSub](#)  
*ImplementationUIDSub.*

## Namespaces

- [gdcmm](#)
- [gdcmm::network](#)

## 11.121 gdcmmImplementationVersionNameSub.h File Reference

```
#include "gdcmmTypes.h"
```

Include dependency graph for gdcmmImplementationVersionNameSub.h:

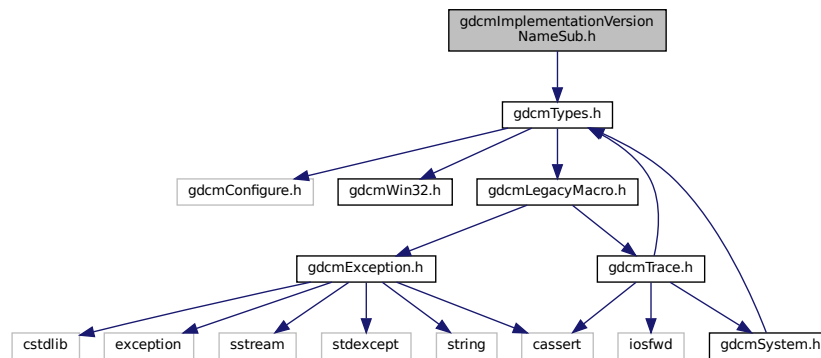

This graph shows which files directly or indirectly include this file:

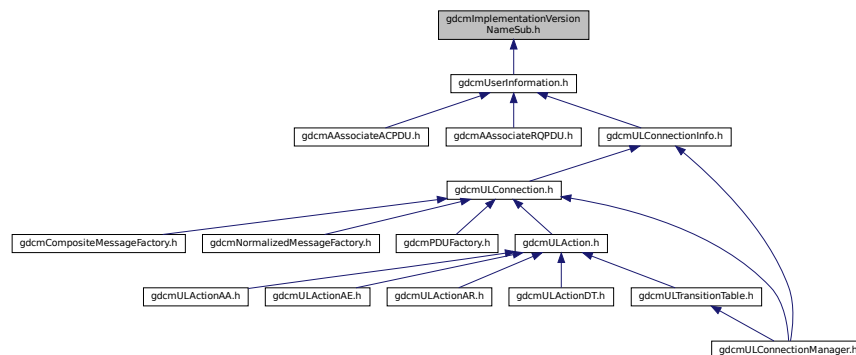

## Classes

- class [gdcm::network::ImplementationVersionNameSub](#)  
*ImplementationVersionNameSub.*

## Namespaces

- [gdcm](#)
- [gdcm::network](#)

## 11.122 gdcmImplicitDataElement.h File Reference

```
#include "gdcmDataElement.h"
#include "gdcmImplicitDataElement.txx"
Include dependency graph for gdcmImplicitDataElement.h:
```

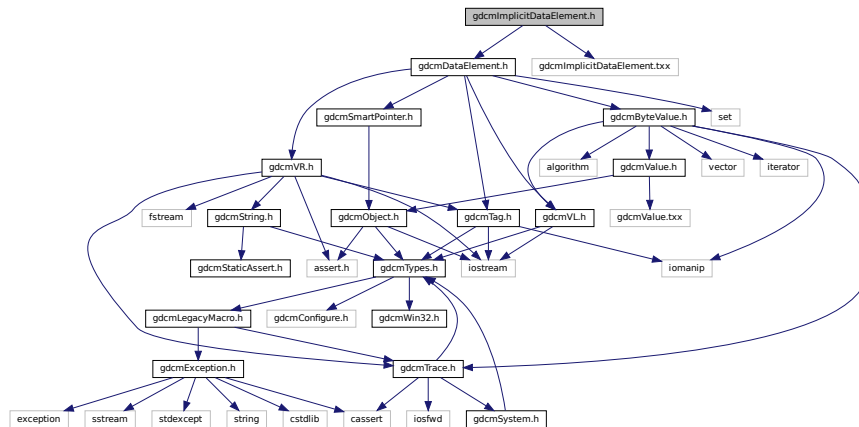

## Classes

- class [gdcm::ImplicitDataElement](#)  
*Class to represent an Implicit VR Data Element.*

## Namespaces

- [gdcm](#)

## 11.123 gdcmIOD.h File Reference

```
#include "gdcmTypes.h"
#include "gdcmTag.h"
#include "gdcmIOEntry.h"
#include <vector>
```

Include dependency graph for gdcmIOD.h:

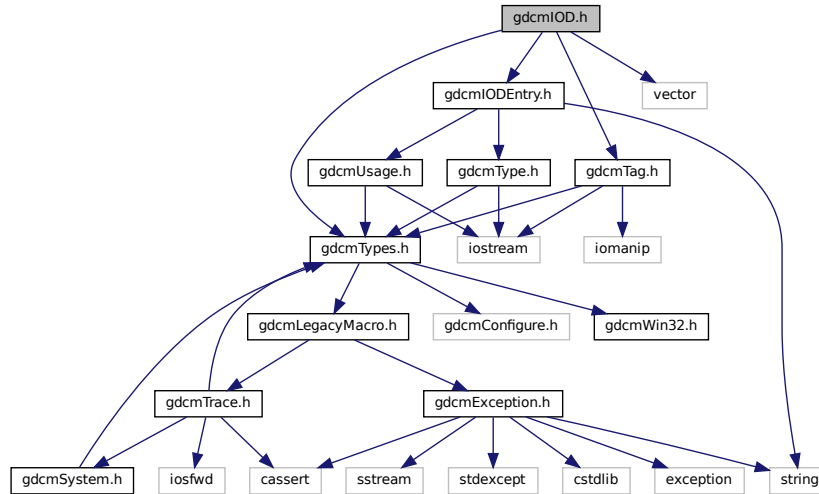

This graph shows which files directly or indirectly include this file:

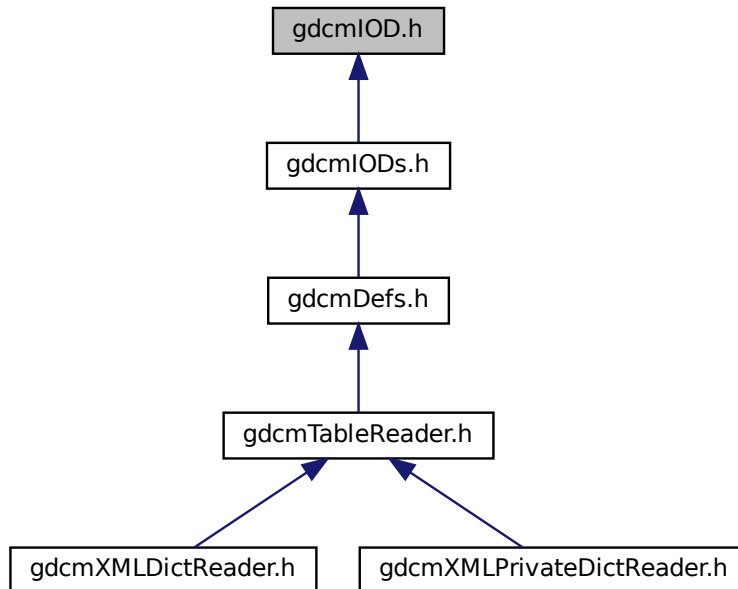

## Classes

- class [gdcm::IOD](#)  
*Class for representing a IOD.*

## Namespaces

- [gdcm](#)

## Functions

- `std::ostream & gdcm::operator<< (std::ostream &_os, const IOD &_val)`

## 11.124 gdcmIODEntry.h File Reference

```
#include "gdcmUsage.h"  
#include "gdcmType.h"
```

```
#include <string>
```

Include dependency graph for gdcmlODEntry.h:

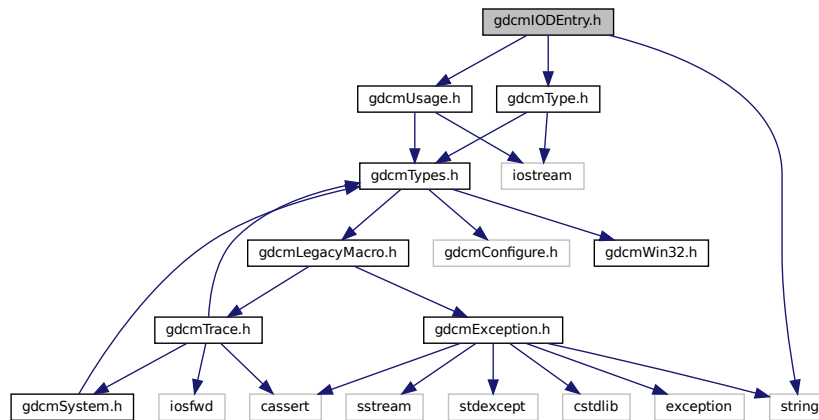

This graph shows which files directly or indirectly include this file:

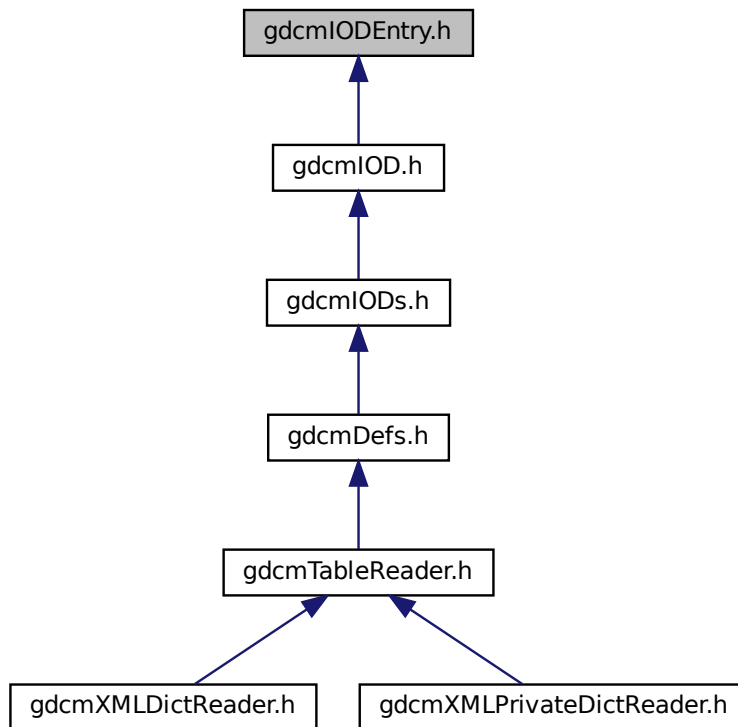

## Classes

- class [gdcm::IODEntry](#)  
Class for representing a *IODEntry*.

## Namespaces

- [gdcm](#)

## Functions

- `std::ostream & gdcm::operator<< (std::ostream &_os, const IODEntry &_val)`

## 11.125 gdcmIODs.h File Reference

```
#include "gdcmTypes.h"
#include "gdcmIOD.h"
#include <map>
```

Include dependency graph for gdcmIODs.h:

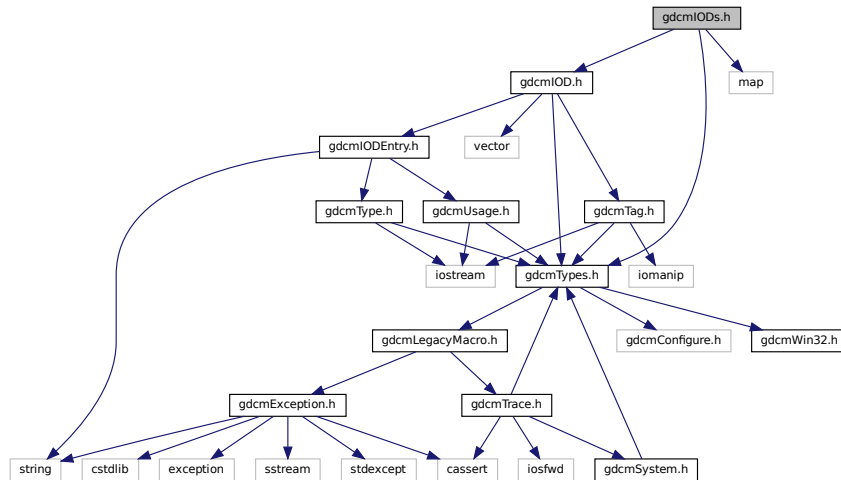

This graph shows which files directly or indirectly include this file:

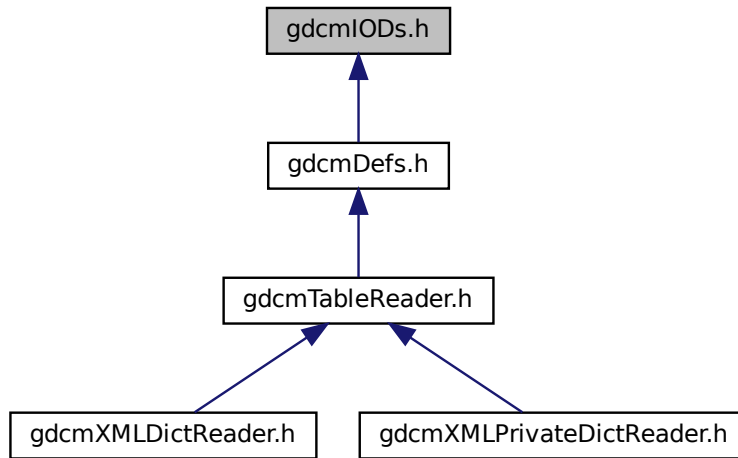

## Classes

- class [gdcml::IODs](#)  
*Class for representing a IODs.*

## Namespaces

- [gdcml](#)

## Functions

- `std::ostream & gdcml::operator<< (std::ostream &_os, const IODs &_val)`

## 11.126 gdcmlPPSorter.h File Reference

```
#include "gdcmlSorter.h"  
#include <vector>
```



```
#include <string>
```

Include dependency graph for gdcmIPPSorter.h:

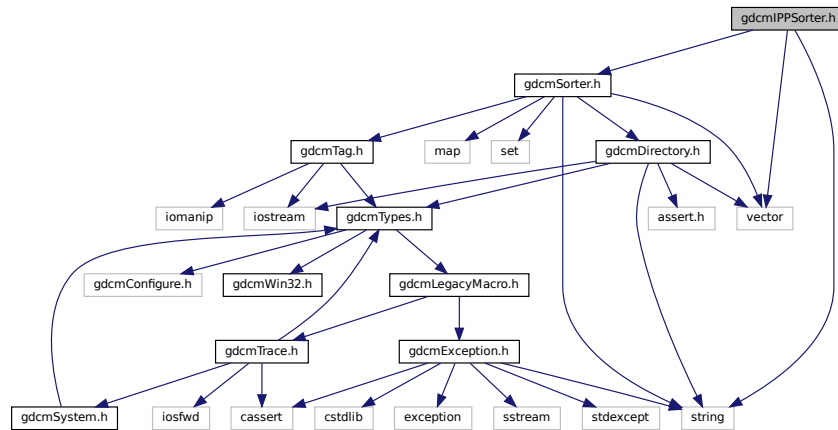

## Classes

- class [gdcm::IPPSorter](#)  
*IPPSorter.*

## Namespaces

- [gdcm](#)

## 11.127 gdcmItem.h File Reference

```
#include "gdcmDataElement.h"
#include "gdcmDataSet.h"
#include "gdcmParseException.h"
#include "gdcmSwapper.h"
#include "gdcmItem.txx"
```

Include dependency graph for `gdcmItem.h`:

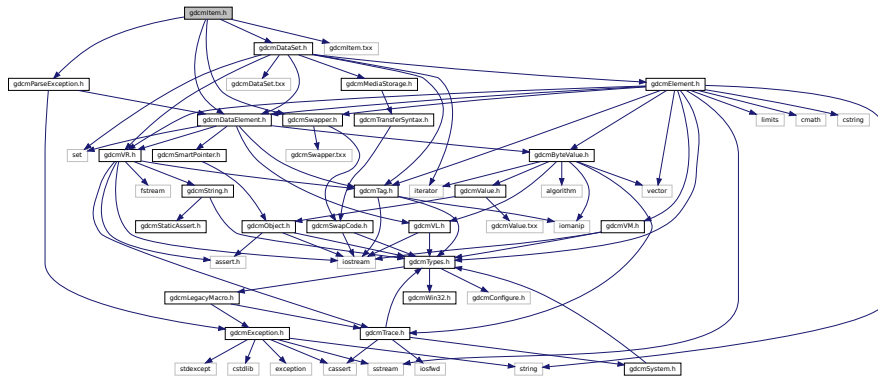

This graph shows which files directly or indirectly include this file:

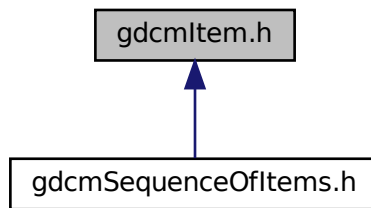

## Classes

- class `gdcm::Item`  
*Class to represent an `Item`.*

## Namespaces

- `gdcm`

## Functions

- `std::ostream & gdcm::operator<< (std::ostream &os, const Item &val)`

## 11.128 gdcmJPEG12Codec.h File Reference

```
#include "gdcmJPEGCodec.h"
```

Include dependency graph for gdcmJPEG12Codec.h:

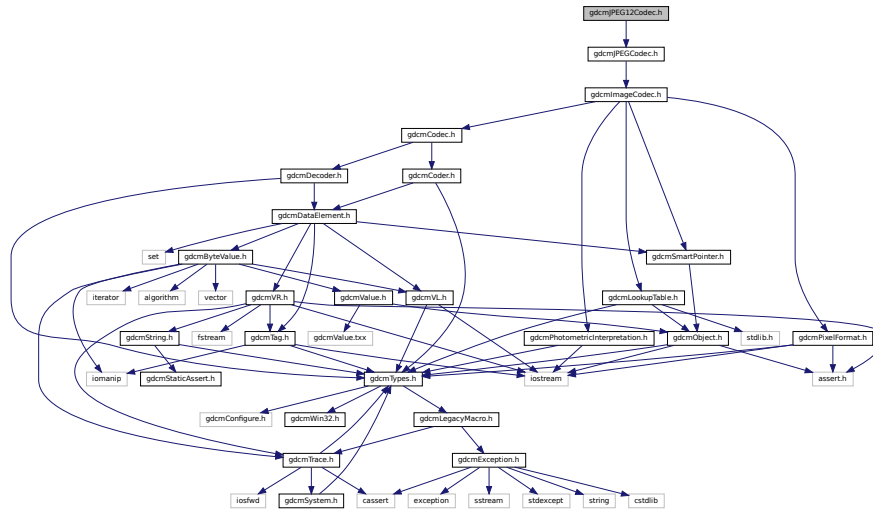

### Classes

- class [gdcm::JPEG12Codec](#)  
Class to do JPEG 12bits (lossy & lossless)

### Namespaces

- [gdcm](#)

## 11.129 gdcmJPEG16Codec.h File Reference

```
#include "gdcmJPEGCodec.h"
```

Include dependency graph for `gdcMJPEG16Codec.h`:

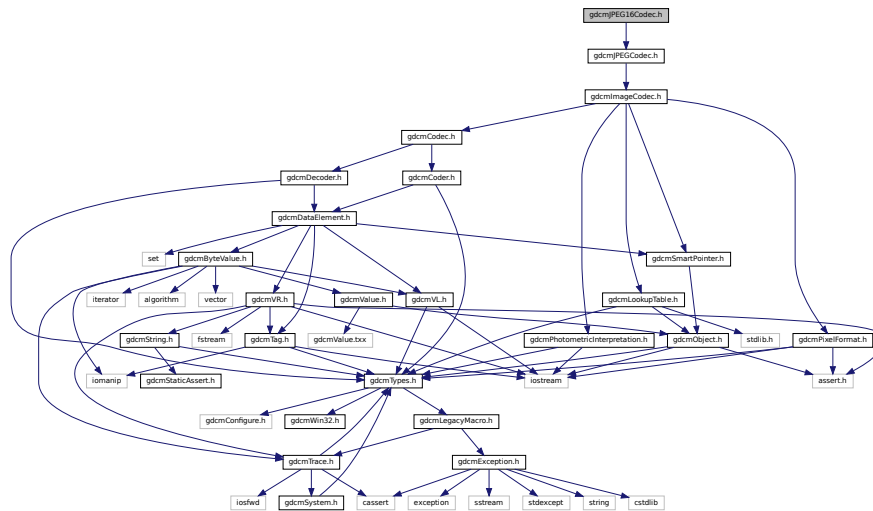

## Classes

- class `gdcm::JPEG16Codec`  
Class to do JPEG 16bits (lossless)

## Namespaces

- `gdcm`

## 11.130 gdcMJPEG2000Codec.h File Reference

```
#include "gdcmImageCodec.h"
```

Include dependency graph for `gdcMJPEG2000Codec.h`:

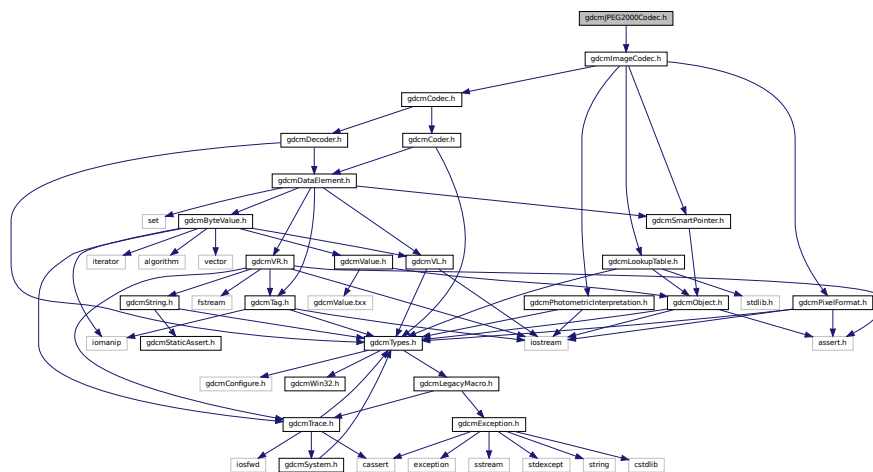



## 11.132 gdcMJPEGCodec.h File Reference

```
#include "gdcmImageCodec.h"
```

Include dependency graph for gdcMJPEGCodec.h:

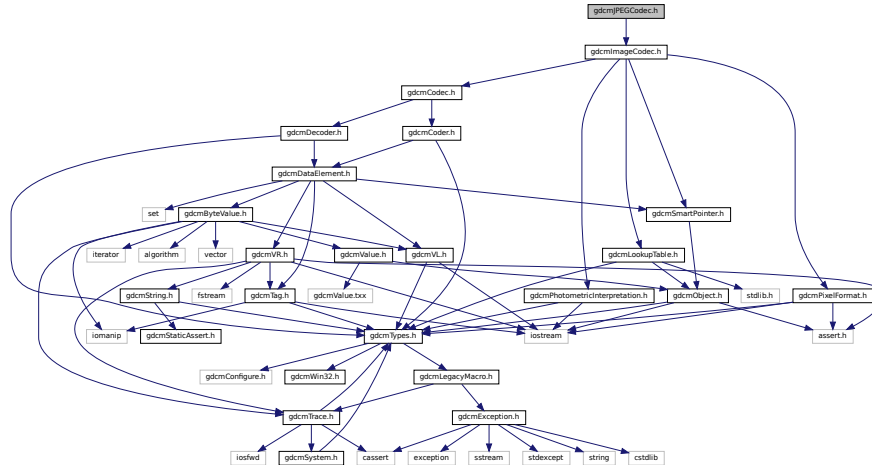

This graph shows which files directly or indirectly include this file:

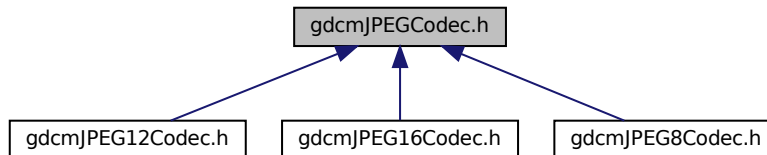

### Classes

- class [gdcm::JPEGCodec](#)  
*JPEG codec.*

### Namespaces

- [gdcm](#)

## 11.133 gdcMJPEGLSCodec.h File Reference

```
#include "gdcmImageCodec.h"
```

Include dependency graph for gdcMJPEGLSCodec.h:

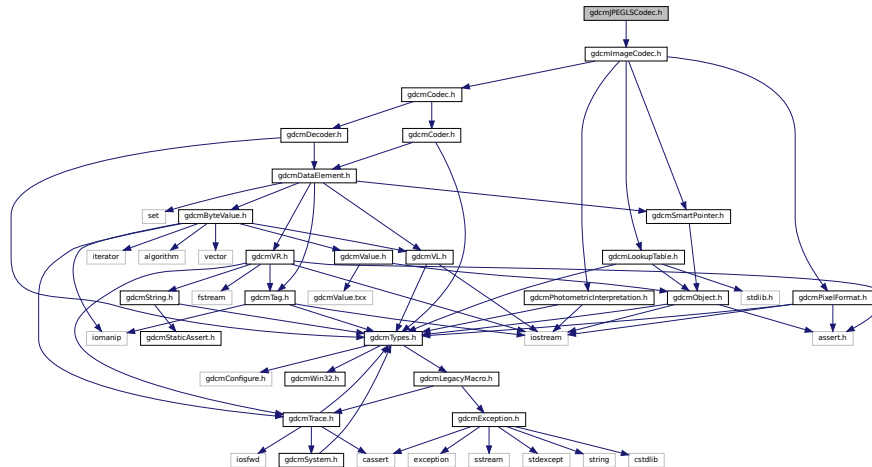

### Classes

- class [gdcm::JPEGLSCodec](#)  
*JPEG-LS.*

### Namespaces

- [gdcm](#)

## 11.134 gdcmJSON.h File Reference

```
#include "gdcmFile.h"
```

```
#include "gdcmDataElement.h"
```

Include dependency graph for `gdcJSON.h`:

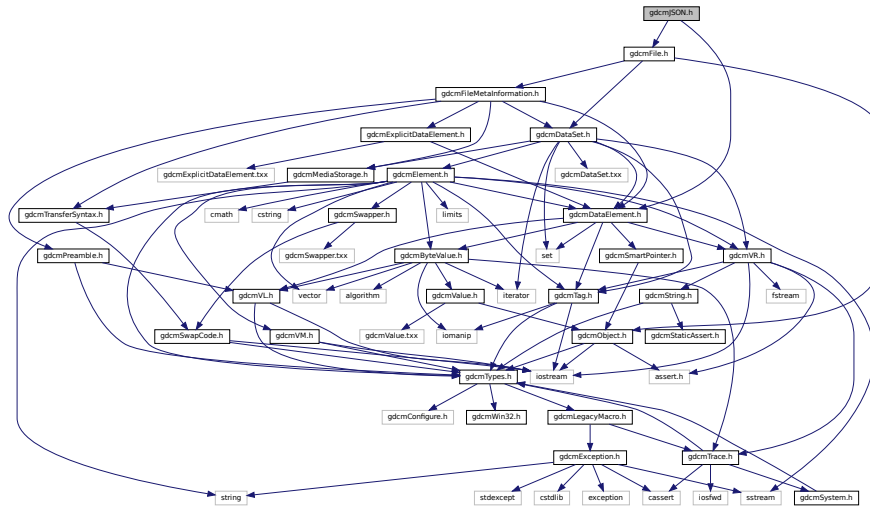

## Classes

- class `gdc::JSON`

## Namespaces

- `gdc`

## 11.135 gdcKAKADUCodec.h File Reference

```
#include "gdcImageCodec.h"
```

Include dependency graph for `gdcKAKADUCodec.h`:

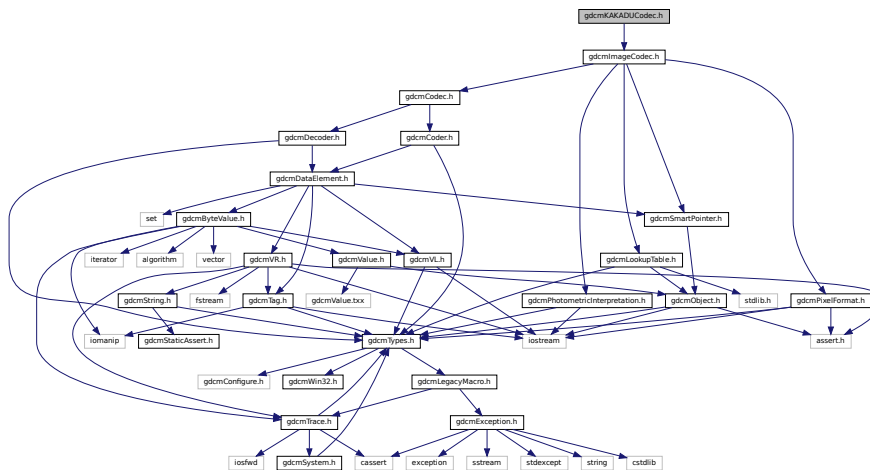



## Classes

- class [gdcm::KAKADUCodec](#)  
*KAKADUCodec.*

## Namespaces

- [gdcm](#)

## 11.136 gdcmLegacyMacro.h File Reference

```
#include "gdcmException.h"
#include "gdcmTrace.h"
Include dependency graph for gdcmLegacyMacro.h:
```

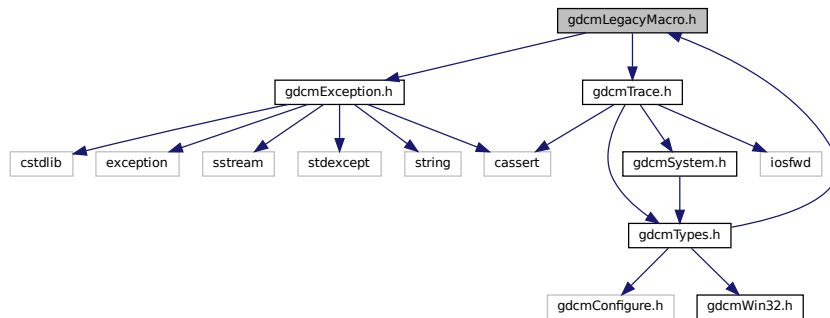

This graph shows which files directly or indirectly include this file:



## Macros

- #define [GDCM\\_LEGACY](#)(method) method;
- #define [GDCM\\_LEGACY\\_BODY](#)(method, version) [gdcmWarningMacro](#)(#method " was deprecated for " version " and will be removed in a future version.")
- #define [GDCM\\_LEGACY\\_REPLACED\\_BODY](#)(method, version, replace) [gdcmWarningMacro](#)(#method " was deprecated for " version " and will be removed in a future version. Use " #replace " instead.")
- #define [GDCM\\_NOOP\\_STATEMENT](#) static\_assert(true, "")

### 11.136.1 Macro Definition Documentation

### 11.136.1.1 GDCM\_LEGACY

```
#define GDCM_LEGACY(  
    method ) method;
```

### 11.136.1.2 GDCM\_LEGACY\_BODY

```
#define GDCM_LEGACY_BODY(  
    method,  
    version ) gdcmWarningMacro(#method " was deprecated for " version " and will be  
removed in a future version.")
```

### 11.136.1.3 GDCM\_LEGACY\_REPLACED\_BODY

```
#define GDCM_LEGACY_REPLACED_BODY(  
    method,  
    version,  
    replace ) gdcmWarningMacro(#method " was deprecated for " version " and will be  
removed in a future version. Use " #replace " instead.")
```

### 11.136.1.4 GDCM\_NOOP\_STATEMENT

```
#define GDCM_NOOP_STATEMENT static_assert(true, "")
```

The `static_assert(true, "")` idiom is commonly employed for C++11 or greater to ensure that it is compile-time only check that can not be part of the binary file. This allows a macro to be used anywhere that a statement is expected, and to enforce consistent use of `;` after a macro. The `static_assert` is a `constexpr` that can be used in places where raw statements (i.e. `'do{} while(0)'`) are not allowed (i.e. after class member function definitions).

## 11.137 gdcmLO.h File Reference

```
#include "gdcmString.h"
```

Include dependency graph for gdcmLO.h:

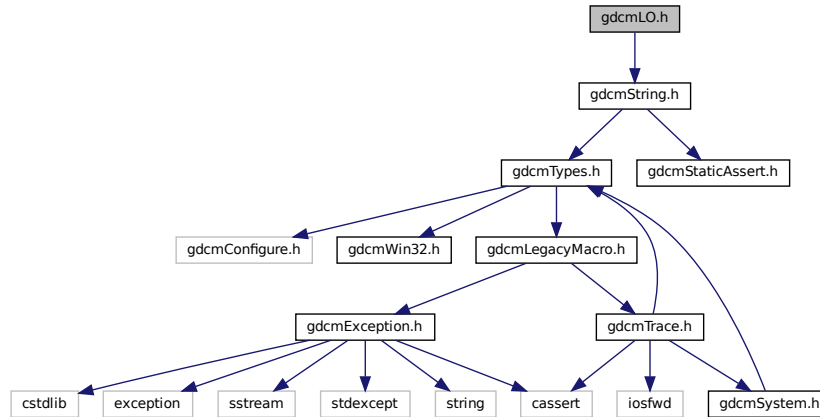

### Classes

- class `gdcm::LO`  
`LO`.

### Namespaces

- `gdcm`

## 11.138 gdcmLookupTable.h File Reference

```
#include "gdcmTypes.h"
```

```
#include "gdcmObject.h"
```

```
#include <stdlib.h>
Include dependency graph for gdcmLookupTable.h:
```

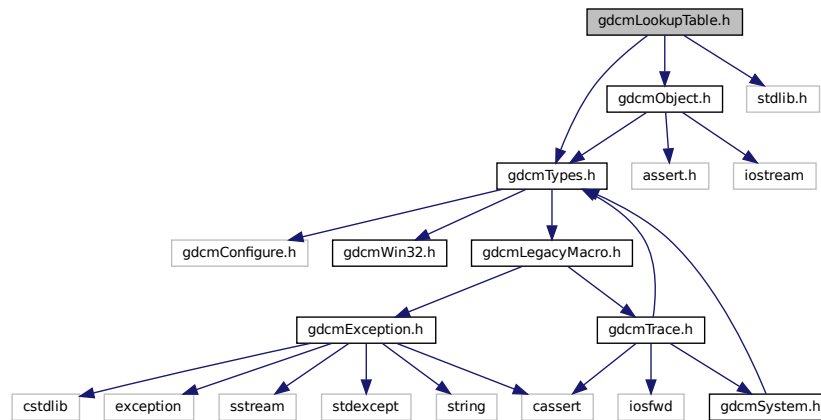

This graph shows which files directly or indirectly include this file:

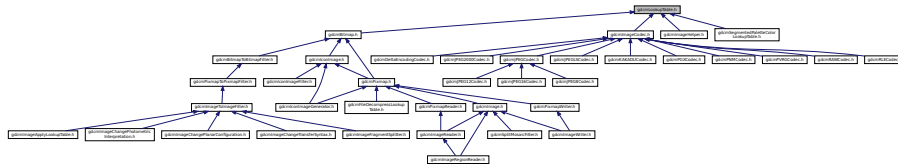

## Classes

- class [gdcm::LookupTable](#)  
*LookupTable class.*

## Namespaces

- [gdcm](#)

## 11.139 gdcmMacro.h File Reference

```
#include "gdcmTypes.h"
#include "gdcmTag.h"
#include "gdcmMacroEntry.h"
#include <map>
```

```
#include <vector>
```

Include dependency graph for gdcmMacro.h:

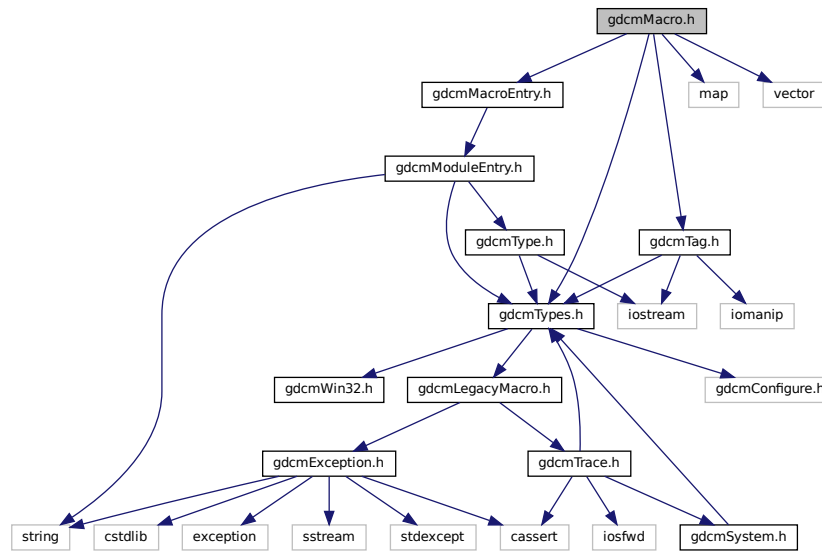

This graph shows which files directly or indirectly include this file:

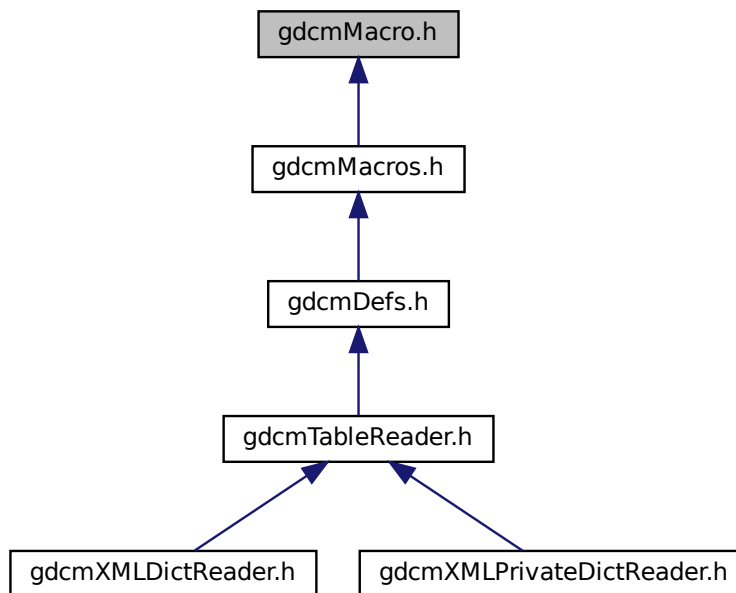

## Classes

- class [gdcM::Macro](#)  
Class for representing a *Macro*.

## Namespaces

- [gdcM](#)

## Functions

- `std::ostream & gdcM::operator<< (std::ostream &_os, const Macro &_val)`

## 11.140 gdcMMacroEntry.h File Reference

```
#include "gdcMModuleEntry.h"
```

Include dependency graph for `gdcMMacroEntry.h`:

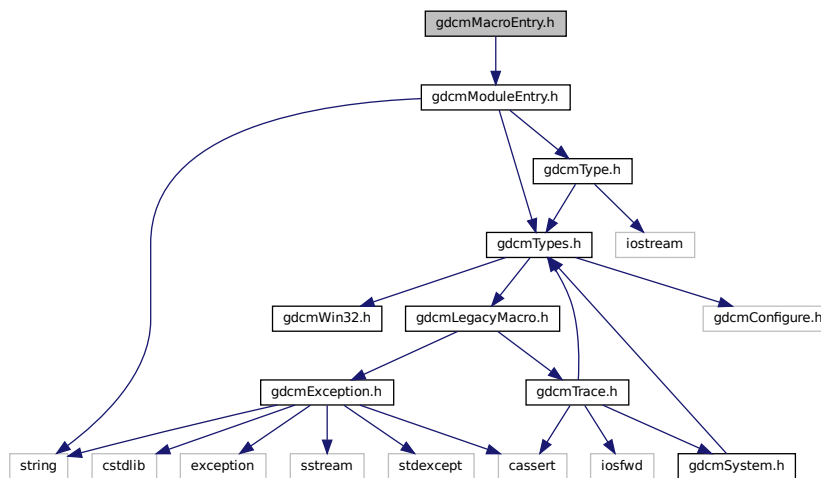

This graph shows which files directly or indirectly include this file:

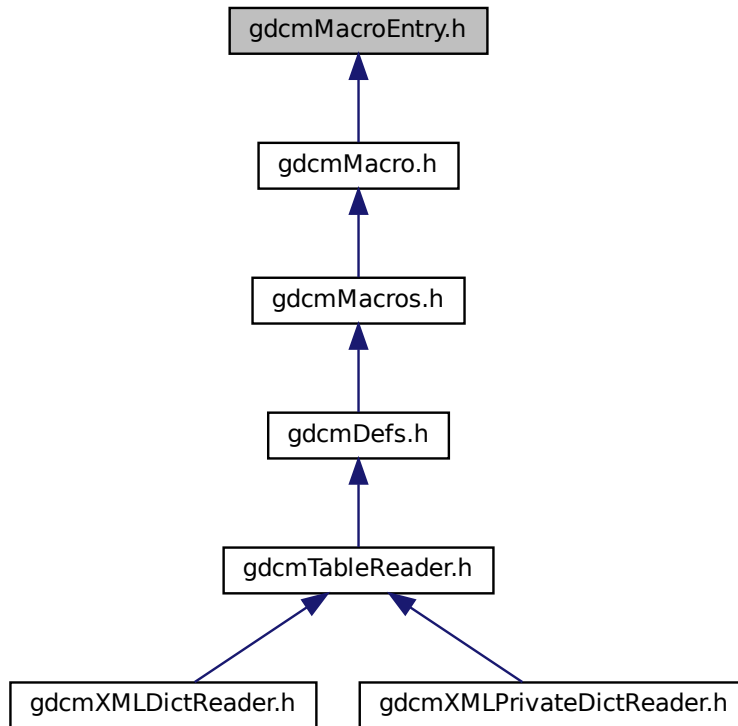

## Macros

- #define [GDCMMACROENTRY\\_H](#)

### 11.140.1 Macro Definition Documentation

#### 11.140.1.1 GDCMMACROENTRY\_H

```
#define GDCMMACROENTRY_H
```

## 11.141 gdcmMacros.h File Reference

```
#include "gdcmTypes.h"
#include "gdcmMacro.h"
#include <map>
```

Include dependency graph for gdcmMacros.h:

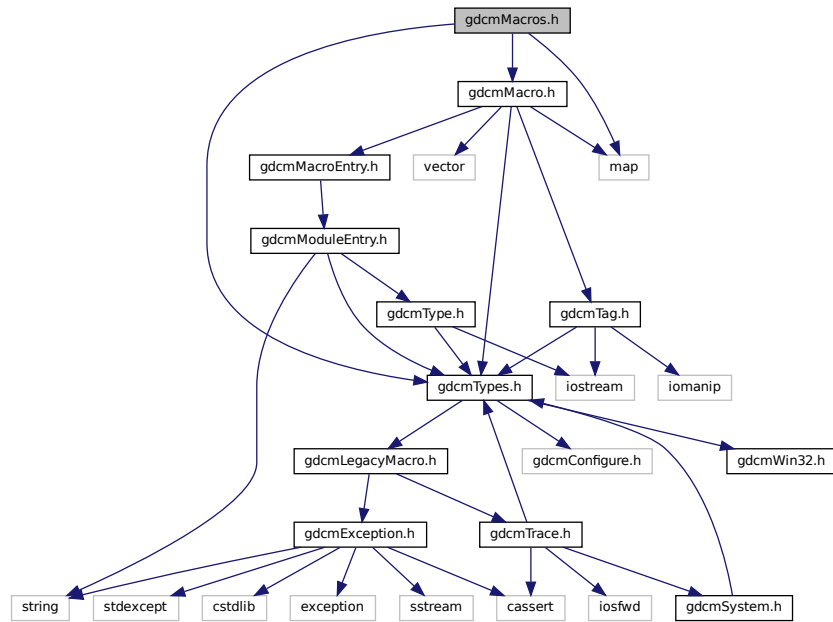



This graph shows which files directly or indirectly include this file:

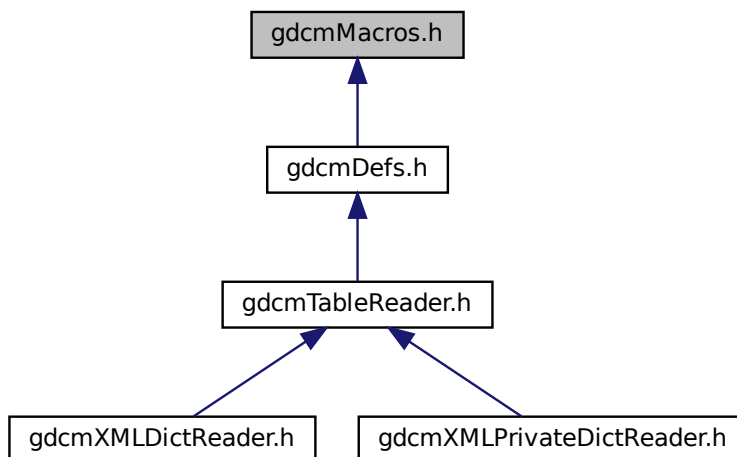

## Classes

- class [gdcm::Macros](#)  
*Class for representing a [Modules](#).*

## Namespaces

- [gdcm](#)

## Functions

- `std::ostream & gdcm::operator<< (std::ostream &_os, const Macros &_val)`

## 11.142 gdcmMaximumLengthSub.h File Reference

```
#include "gdcmTypes.h"
```

Include dependency graph for `gdcMaximumLengthSub.h`:

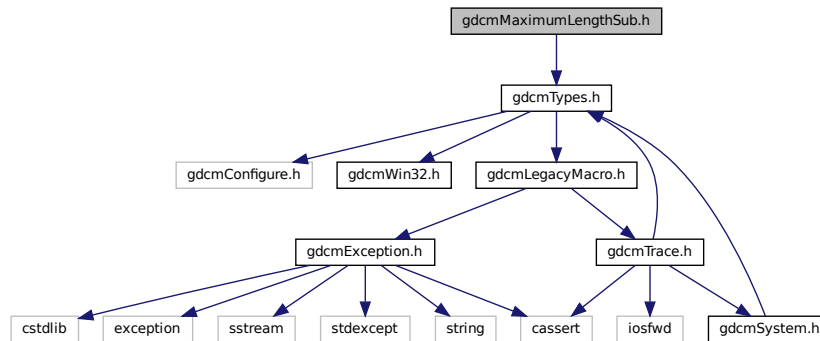

This graph shows which files directly or indirectly include this file:

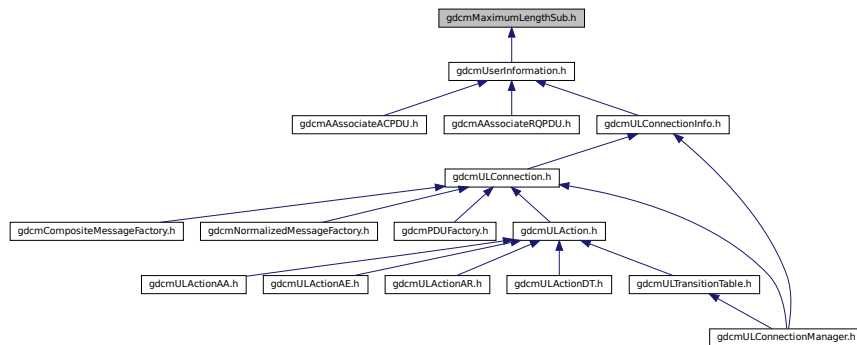

## Classes

- class `gdcm::network::MaximumLengthSub`  
*MaximumLengthSub*.

## Namespaces

- `gdcm`
- `gdcm::network`

## 11.143 gdcMD5.h File Reference

```
#include "gdcTypes.h"
```

Include dependency graph for gdcMD5.h:

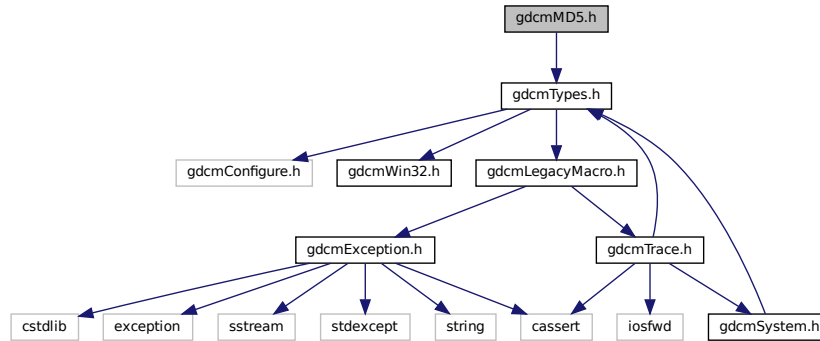

### Classes

- class [gdc::MD5](#)  
*Class for MD5.*

### Namespaces

- [gdc](#)

## 11.144 gdcMediaStorage.h File Reference

```
#include "gdcTransferSyntax.h"
```

Include dependency graph for `gdcMMediaStorage.h`:

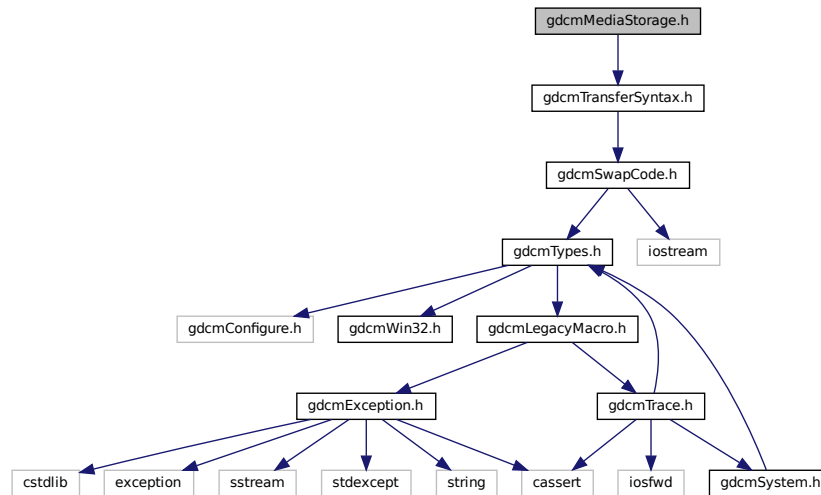

This graph shows which files directly or indirectly include this file:

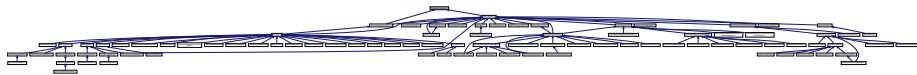

## Classes

- class `gdcM::MediaStorage`  
*MediaStorage.*

## Namespaces

- `gdcM`

## Functions

- `std::ostream & gdcM::operator<< (std::ostream &_os, const MediaStorage &ms)`

## 11.145 gdcMeshPrimitive.h File Reference

```
#include <gdcObject.h>
```

```
#include <gdcDataElement.h>
```

Include dependency graph for gdcMeshPrimitive.h:

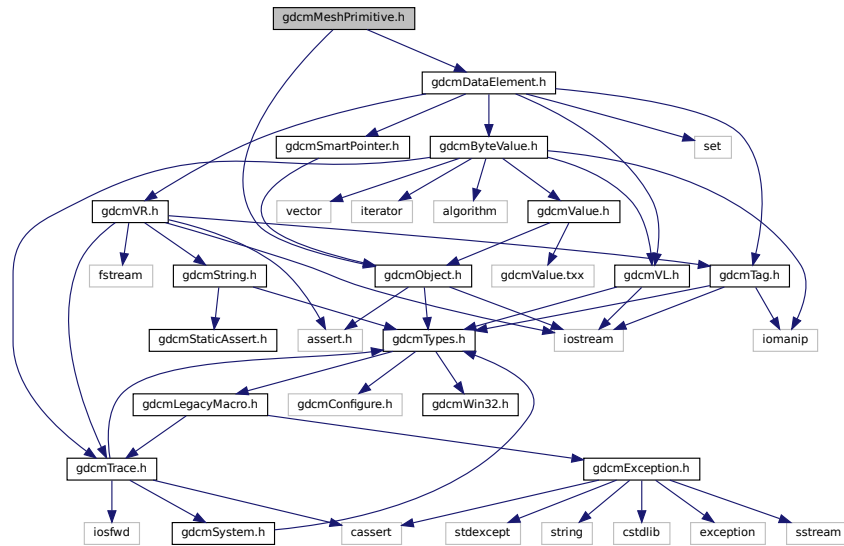

This graph shows which files directly or indirectly include this file:

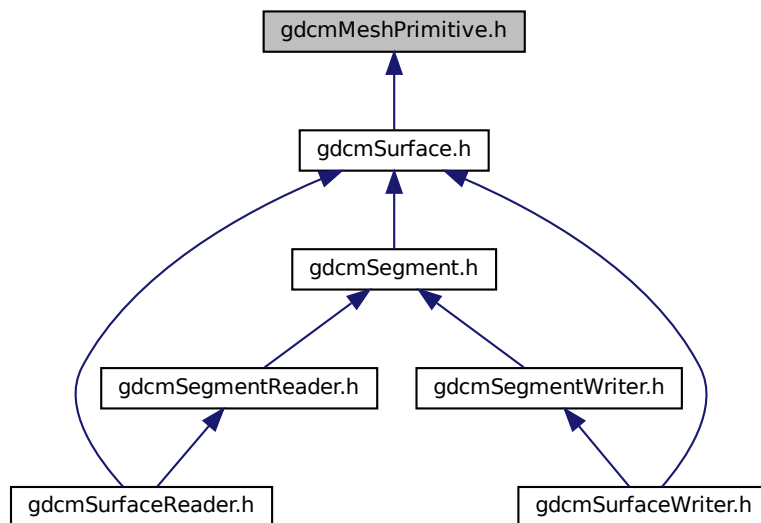



## 11.147 `gdcmModalityPerformedProcedureStepSetQuery.h` File Reference

```
#include "gdcmBaseQuery.h"
```

Include dependency graph for `gdcmModalityPerformedProcedureStepSetQuery.h`:

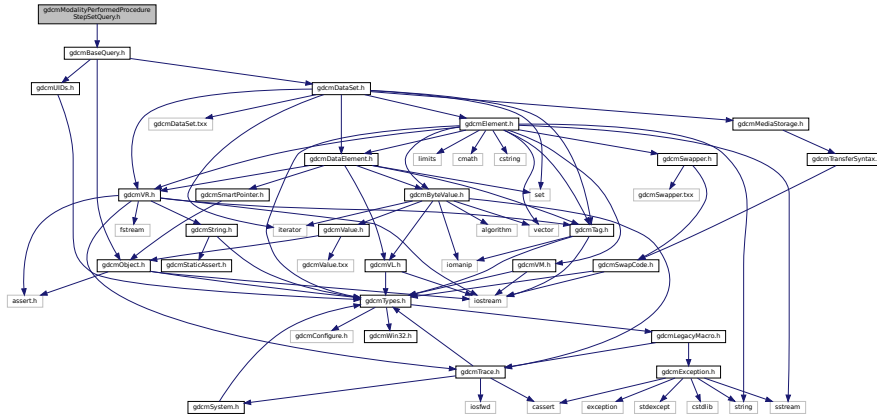

### Classes

- class `gdcm::ModalityPerformedProcedureStepSetQuery`  
*ModalityPerformedProcedureStepSetQuery.*

### Namespaces

- `gdcm`

## 11.148 `gdcmModule.h` File Reference

```
#include "gdcmTypes.h"
#include "gdcmTag.h"
#include "gdcmModuleEntry.h"
#include <map>
```

```
#include <vector>
```

Include dependency graph for gdcmModule.h:

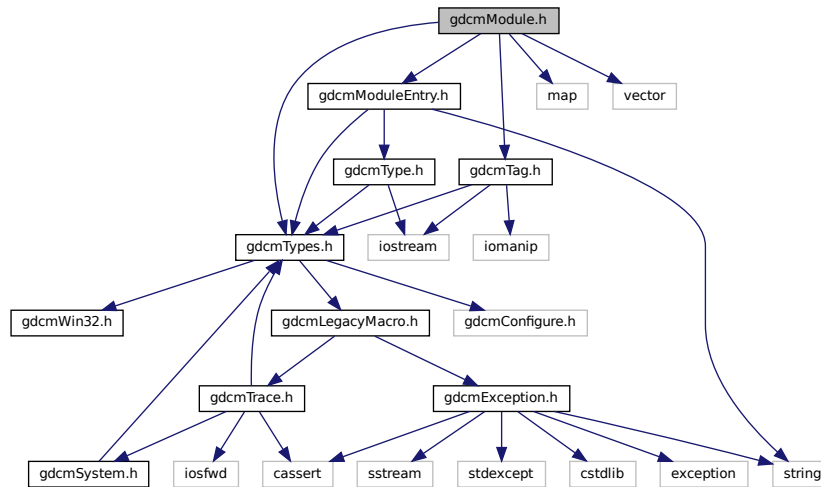

This graph shows which files directly or indirectly include this file:

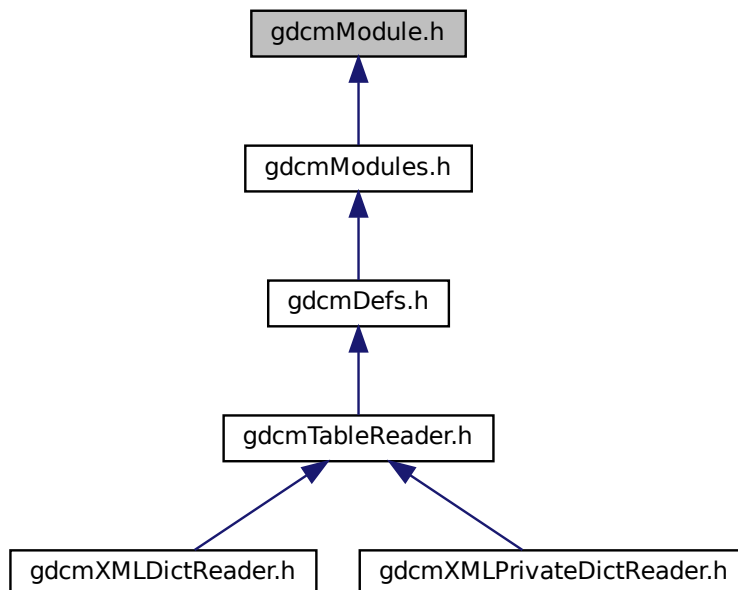



## Classes

- class [gdcm::Module](#)  
Class for representing a *Module*.

## Namespaces

- [gdcm](#)

## Functions

- std::ostream & [gdcm::operator<<](#) (std::ostream &\_os, const Module &\_val)

## 11.149 gdcmModuleEntry.h File Reference

```
#include "gdcmTypes.h"
#include "gdcmType.h"
#include <string>
Include dependency graph for gdcmModuleEntry.h:
```

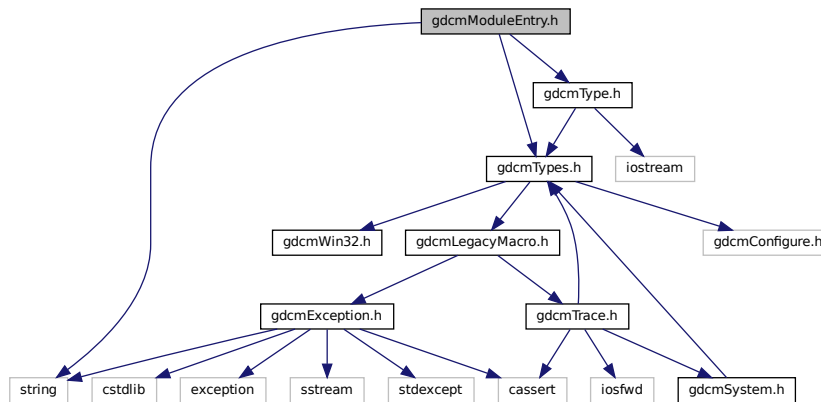

This graph shows which files directly or indirectly include this file:

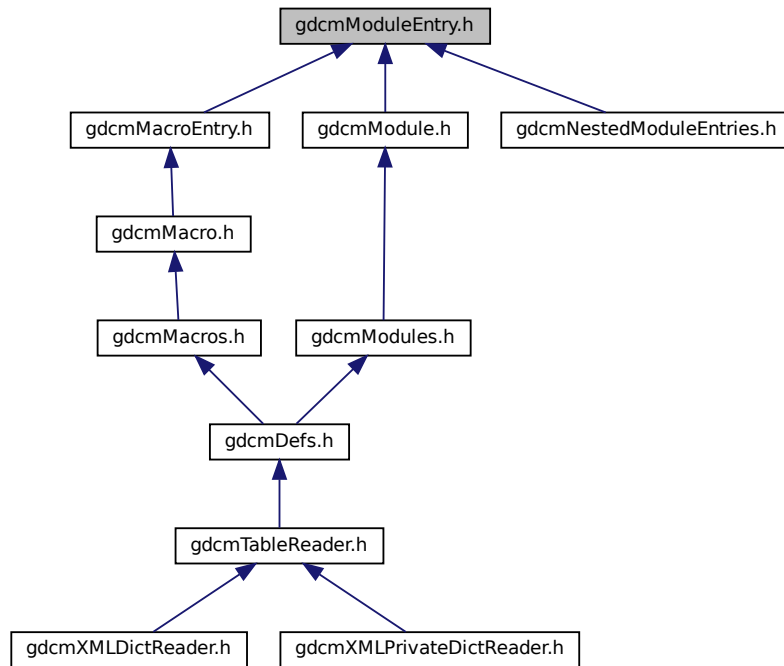

## Classes

- class [gdcm::ModuleEntry](#)  
Class for representing a *ModuleEntry*.

## Namespaces

- [gdcm](#)

## Typedefs

- typedef ModuleEntry [gdcm::MacroEntry](#)

## Functions

- `std::ostream & gdcm::operator<< (std::ostream &_os, const ModuleEntry &_val)`

## 11.150 gdcModules.h File Reference

```
#include "gdcTypes.h"
#include "gdcModule.h"
#include <map>
```

Include dependency graph for gdcModules.h:

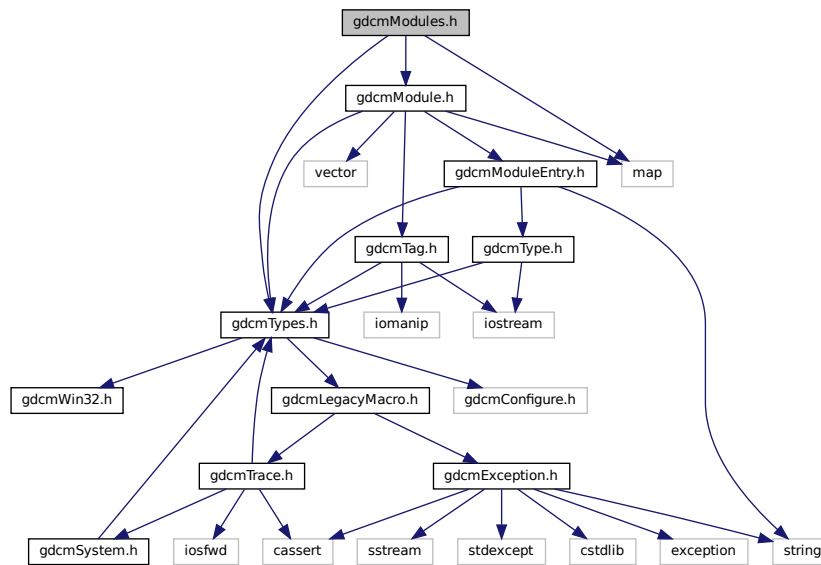

This graph shows which files directly or indirectly include this file:

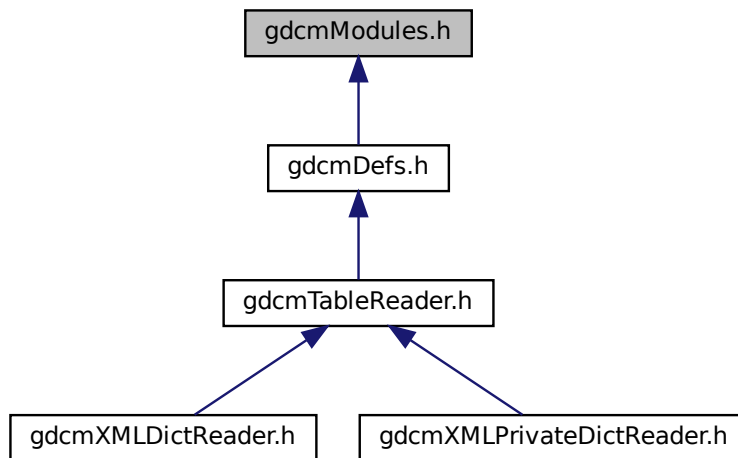

## Classes

- class [gdcM::Modules](#)  
Class for representing a *Modules*.

## Namespaces

- [gdcM](#)

## Functions

- std::ostream & [gdcM::operator<<](#) (std::ostream &\_os, const Modules &\_val)

## 11.151 gdcMMovePatientRootQuery.h File Reference

```
#include "gdcMFindPatientRootQuery.h"
```

Include dependency graph for gdcMMovePatientRootQuery.h:

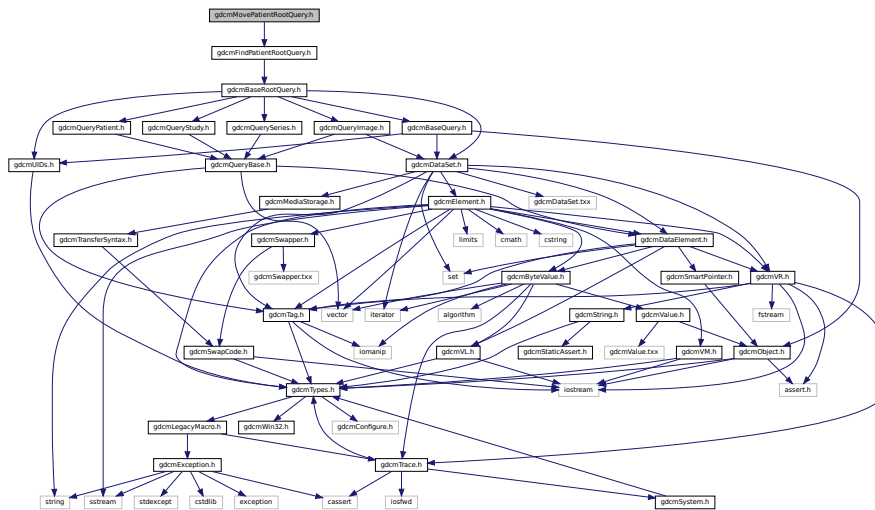

## Classes

- class [gdcM::MovePatientRootQuery](#)  
*MovePatientRootQuery*.

## Namespaces

- [gdcM](#)

## 11.152 gdcMMoveStudyRootQuery.h File Reference

```
#include "gdcMBaseRootQuery.h"
```

Include dependency graph for gdcMMoveStudyRootQuery.h:

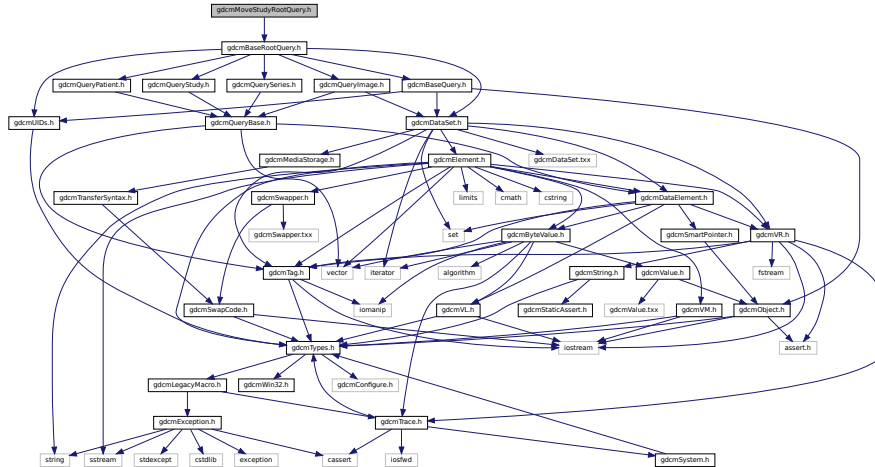

### Classes

- class [gdcM::MoveStudyRootQuery](#)  
*MoveStudyRootQuery.*

### Namespaces

- [gdcM](#)

## 11.153 gdcMMrProtocol.h File Reference

```
#include "gdcMTypes.h"
```

```
#include "gdcMDataSet.h"
```

Include dependency graph for `gdcmMrProtocol.h`:

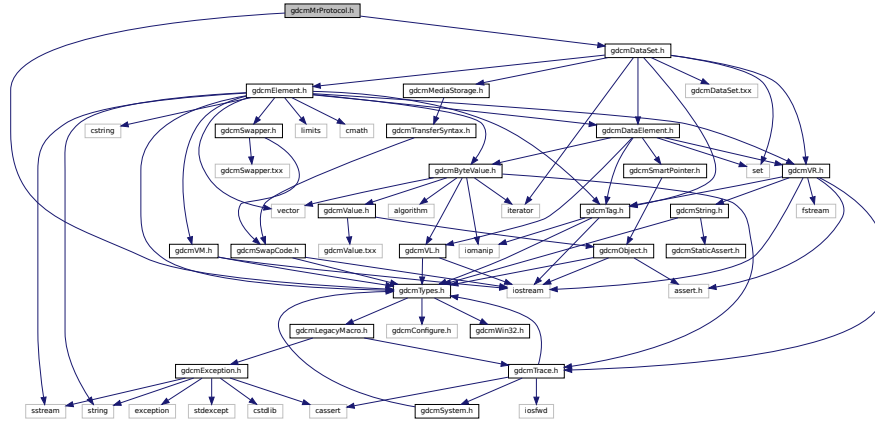

This graph shows which files directly or indirectly include this file:

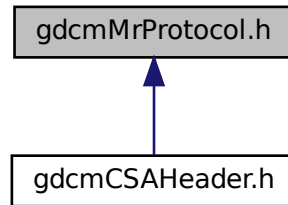

## Classes

- class [gdcm::MrProtocol](#)  
*Class for [MrProtocol](#).*
- struct [gdcm::MrProtocol::Slice](#)
- struct [gdcm::MrProtocol::SliceArray](#)
- struct [gdcm::MrProtocol::Vector3](#)

## Namespaces

- [gdcm](#)

## Functions

- `std::ostream & gdcm::operator<< (std::ostream &os, const MrProtocol &d)`



Include dependency graph for `gdcnNCreateMessages.h`:

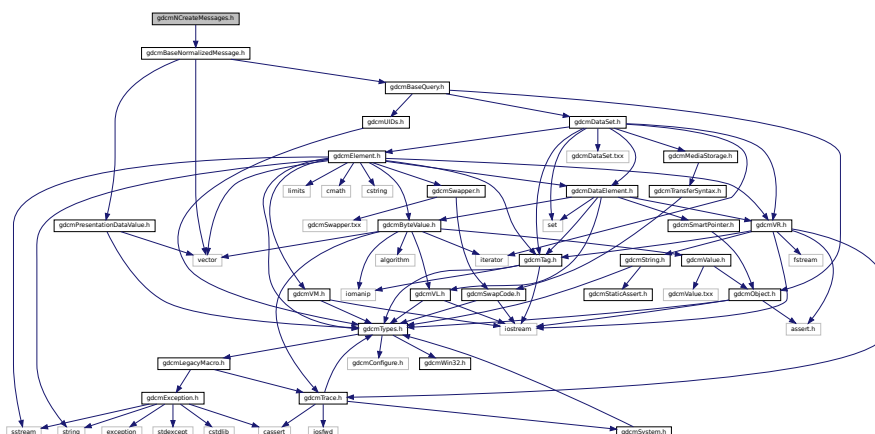

## Classes

- class `gdcn::network::NCreateRQ`  
*NCreateRQ.*
- class `gdcn::network::NCreateRSP`  
*NCreateRSP* this file defines the messages for the *ncreate* action.

## Namespaces

- `gdcn`
- `gdcn::network`

## 11.156 gdcnNDeleteMessages.h File Reference

```
#include "gdcnBaseNormalizedMessage.h"
```

Include dependency graph for `gdcnNDeleteMessages.h`:

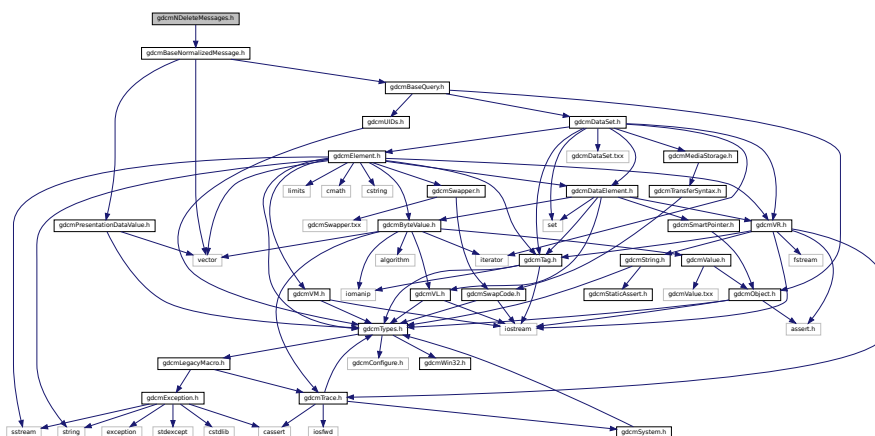



## Classes

- class [gdcn::network::NDeleteRQ](#)  
*NDeleteRQ.*
- class [gdcn::network::NDeleteRSP](#)  
*NDeleteRSP* this file defines the messages for the *ndelete* action.

## Namespaces

- [gdcn](#)
- [gdcn::network](#)

## 11.157 gdcnNestedModuleEntries.h File Reference

```
#include "gdcnModuleEntry.h"
#include <vector>
```

Include dependency graph for `gdcnNestedModuleEntries.h`:

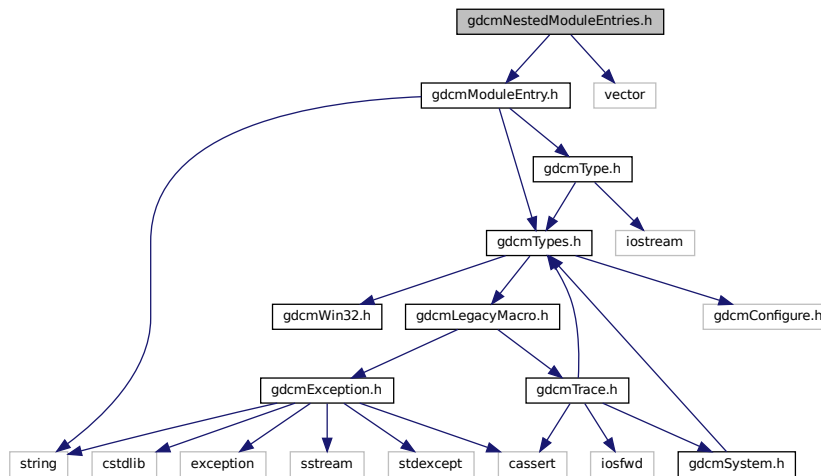

## Classes

- class [gdcn::NestedModuleEntries](#)  
*Class for representing a [NestedModuleEntries](#).*

## Namespaces

- [gdcn](#)

## Typedefs

- typedef NestedModuleEntries [gdcmm::NestedMacroEntries](#)

## Functions

- `std::ostream & gdcmm::operator<< (std::ostream &_os, const NestedModuleEntries &_val)`

## 11.158 gdcmmNetworkEvents.h File Reference

This graph shows which files directly or indirectly include this file:

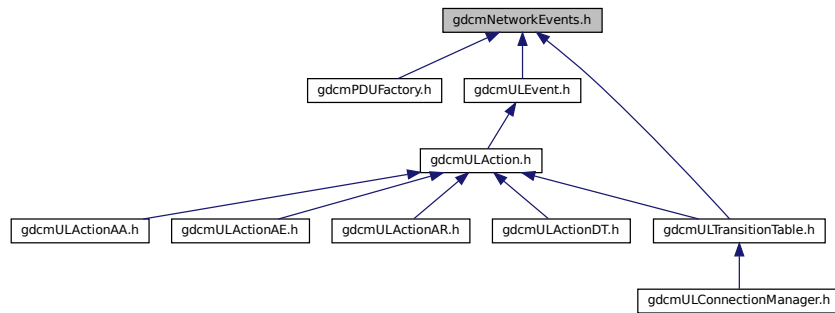

## Namespaces

- [gdcmm](#)
- [gdcmm::network](#)

## Enumerations

- enum [gdcmm::network::EEventID](#) {  
[gdcmm::network::eAASSOCIATERequestLocalUser](#) = 0 ,  
[gdcmm::network::eTransportConnConfirmLocal](#) ,  
[gdcmm::network::eASSOCIATE\\_ACPDUreceived](#) ,  
[gdcmm::network::eASSOCIATE\\_RJPDUreceived](#) ,  
[gdcmm::network::eTransportConnIndicLocal](#) ,  
[gdcmm::network::eAASSOCIATE\\_RQPDUreceived](#) ,  
[gdcmm::network::eAASSOCIATEResponseAccept](#) ,  
[gdcmm::network::eAASSOCIATEResponseReject](#) ,  
[gdcmm::network::ePDATArequest](#) ,  
[gdcmm::network::ePDATATFPDU](#) ,  
[gdcmm::network::eARELEASERequest](#) ,  
[gdcmm::network::eARELEASE\\_RQPDUReceivedOpen](#) ,  
[gdcmm::network::eARELEASE\\_RPPDUReceived](#) ,

```

gdcNetworkStateID.h:
gdc::network::eARELEASEResponse ,
gdc::network::eAABORTRequest ,
gdc::network::eAABORTPDUReceivedOpen ,
gdc::network::eTransportConnectionClosed ,
gdc::network::eARTIMTimerExpired ,
gdc::network::eUnrecognizedPDUReceived ,
gdc::network::eEventDoesNotExist }

```

## Variables

- const int `gdc::network::cMaxEventID` = eEventDoesNotExist

## 11.159 gdcNetworkStateID.h File Reference

This graph shows which files directly or indirectly include this file:

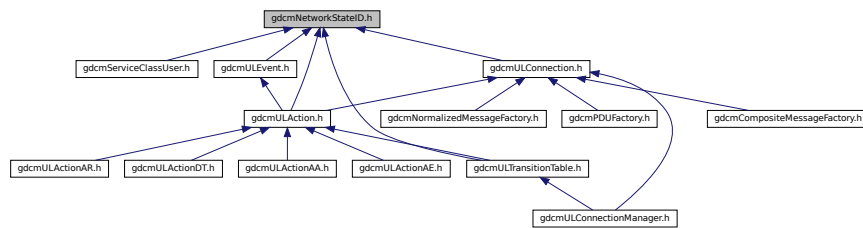

## Namespaces

- `gdc`
- `gdc::network`

## Enumerations

- enum `gdc::network::EStateID` {
  - `gdc::network::eStaDoesNotExist` = 0 ,
  - `gdc::network::eSta1Idle` = 1 ,
  - `gdc::network::eSta2Open` = 2 ,
  - `gdc::network::eSta3WaitLocalAssoc` = 4 ,
  - `gdc::network::eSta4LocalAssocDone` = 8 ,
  - `gdc::network::eSta5WaitRemoteAssoc` = 16 ,
  - `gdc::network::eSta6TransferReady` = 32 ,
  - `gdc::network::eSta7WaitRelease` = 64 ,
  - `gdc::network::eSta8WaitLocalRelease` = 128 ,
  - `gdc::network::eSta9ReleaseCollisionRqLocal` = 256 ,
  - `gdc::network::eSta10ReleaseCollisionAc` = 512 ,
  - `gdc::network::eSta11ReleaseCollisionRq` = 1024 ,
  - `gdc::network::eSta12ReleaseCollisionAcLocal` = 2048 ,
  - `gdc::network::eSta13AwaitingClose` = 4096 }

## Functions

- int [gdcM::network::GetStateIndex](#) (EStateID inState)

## Variables

- const int [gdcM::network::cMaxStateID](#) = 13

## 11.160 gdcMNEventReportMessages.h File Reference

```
#include "gdcMBaseNormalizedMessage.h"  
Include dependency graph for gdcMNEventReportMessages.h:
```

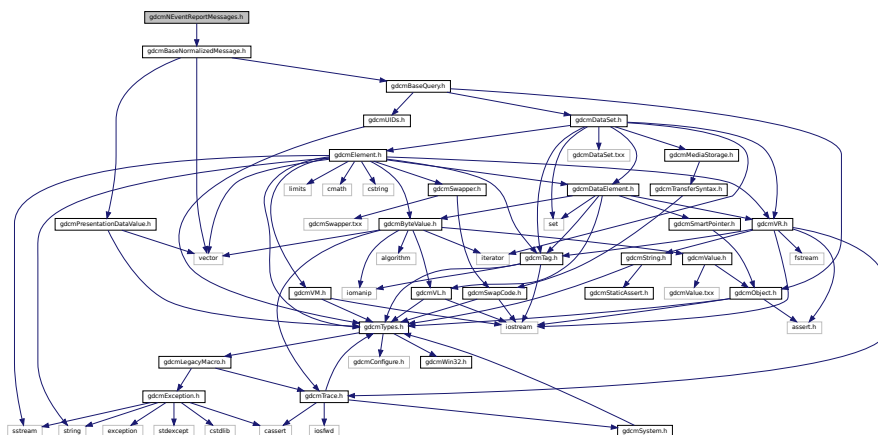

## Classes

- class [gdcM::network::NEventReportRQ](#)  
*NEventReportRQ.*
- class [gdcM::network::NEventReportRSP](#)  
*NEventReportRSP this file defines the messages for the neventreport action.*

## Namespaces

- [gdcM](#)
- [gdcM::network](#)







```
#include <iostream>
```

Include dependency graph for `gdcmObject.h`:

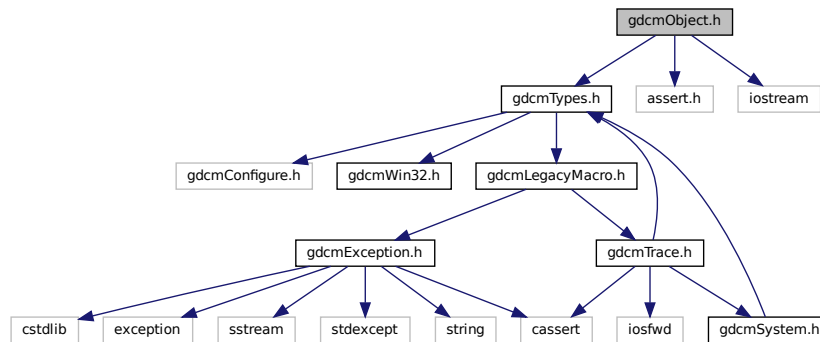

This graph shows which files directly or indirectly include this file:

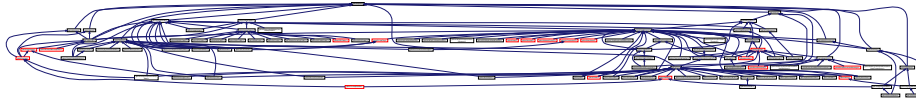

## Classes

- class `gdcm::Object`  
*Object.*

## Namespaces

- `gdcm`

## Functions

- `std::ostream & gdcm::operator<< (std::ostream &os, const Object &obj)`



## 11.166 gdcOpenSSLCryptoFactory.h File Reference

```
#include "gdcCryptoFactory.h"
#include "gdcOpenSSLCryptographicMessageSyntax.h"
Include dependency graph for gdcOpenSSLCryptoFactory.h:
```

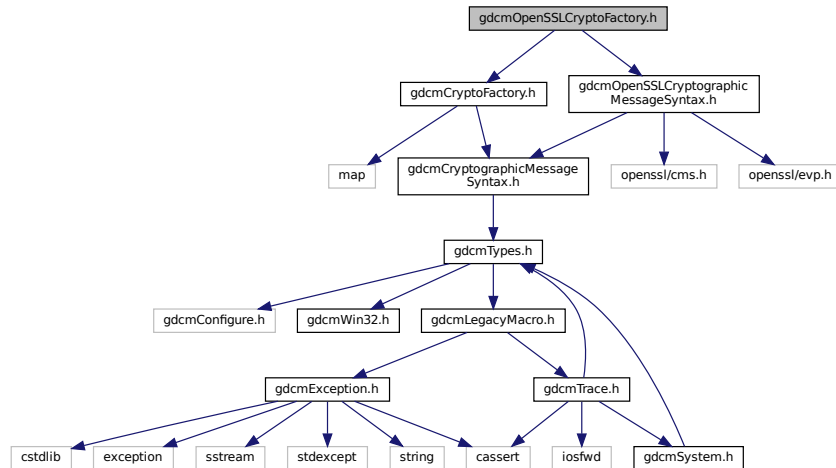

### Classes

- class [gdc::OpenSSLCryptoFactory](#)

### Namespaces

- [gdc](#)

## 11.167 gdcOpenSSLCryptographicMessageSyntax.h File Reference

```
#include "gdcCryptographicMessageSyntax.h"
#include <openssl/cms.h>
```

```
#include <openssl/evp.h>
```

Include dependency graph for `gdcOpenSSLCryptographicMessageSyntax.h`:

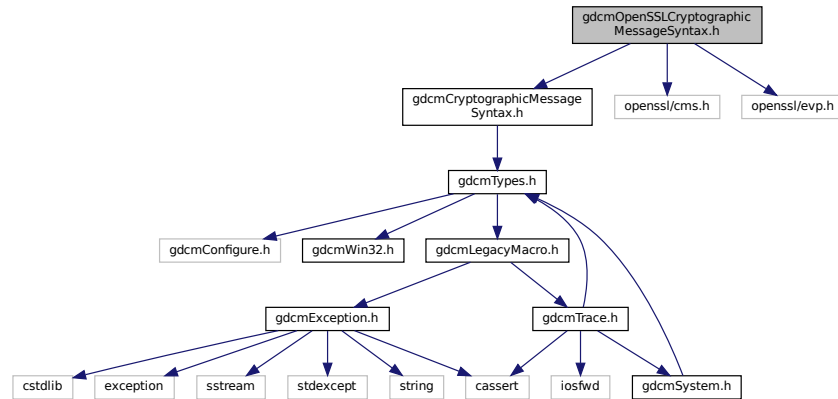

This graph shows which files directly or indirectly include this file:

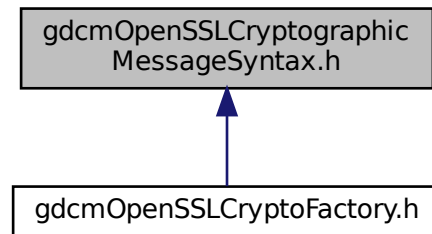

## Classes

- class [gdc::OpenSSLCryptographicMessageSyntax](#)

## Namespaces

- [gdc](#)

## 11.168 gdcOpenSSL7CryptoFactory.h File Reference

```
#include "gdcCryptoFactory.h"
#include "gdcOpenSSL7CryptographicMessageSyntax.h"
Include dependency graph for gdcOpenSSL7CryptoFactory.h:
```

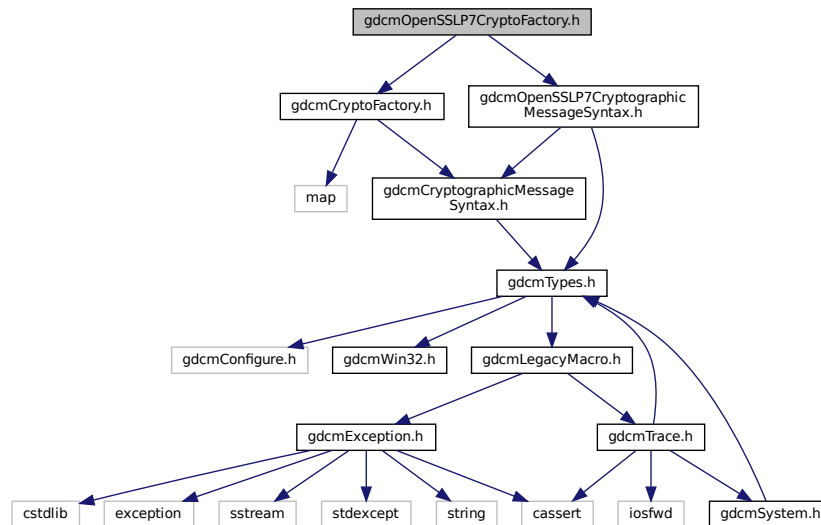

### Classes

- class [gdc::OpenSSL7CryptoFactory](#)

### Namespaces

- [gdc](#)

## 11.169 gdcOpenSSL7CryptographicMessageSyntax.h File Reference

```
#include "gdcCryptographicMessageSyntax.h"
#include "gdcTypes.h"
```

Include dependency graph for `gdcOpenSSL7CryptographicMessageSyntax.h`:

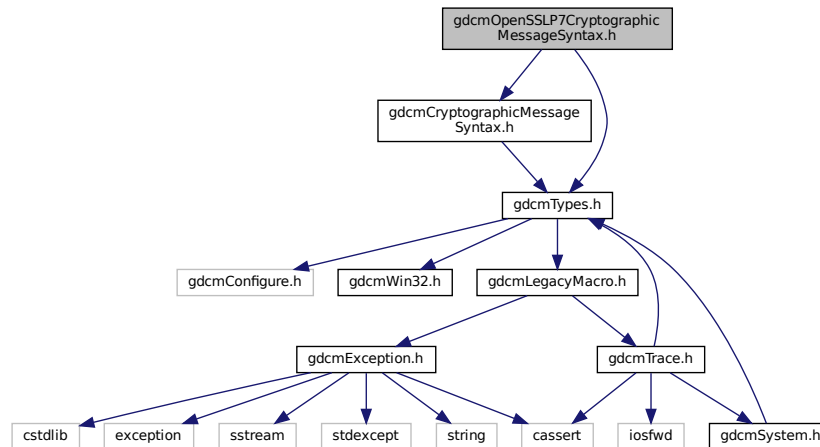

This graph shows which files directly or indirectly include this file:

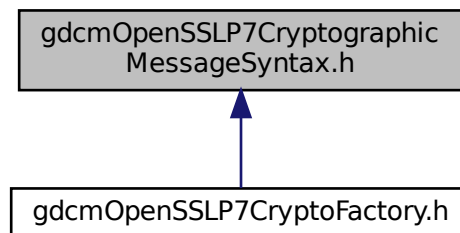

## Classes

- class [gdc::OpenSSL7CryptographicMessageSyntax](#)

## Namespaces

- [gdc](#)

## 11.170 gdcmOrientation.h File Reference

```
#include "gdcmTypes.h"
```

Include dependency graph for gdcmOrientation.h:

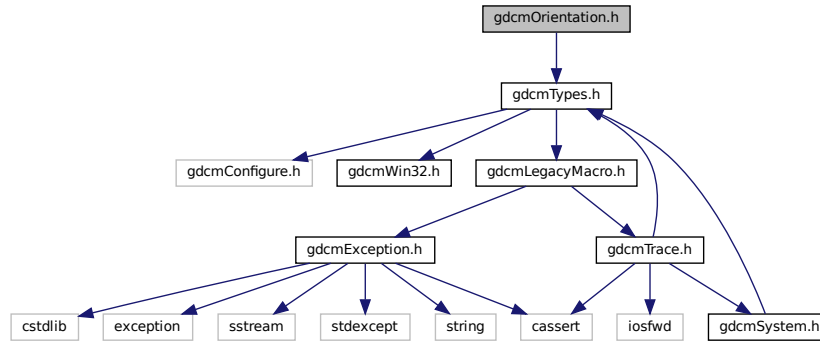

### Classes

- class [gdcm::Orientation](#)  
*class to handle Orientation*

### Namespaces

- [gdcm](#)

### Functions

- `std::ostream & gdcm::operator<< (std::ostream &os, const Orientation &o)`

## 11.171 gdcmOverlay.h File Reference

```
#include "gdcmTypes.h"
```

```
#include "gdcmObject.h"
```

Include dependency graph for `gdcmOverlay.h`:

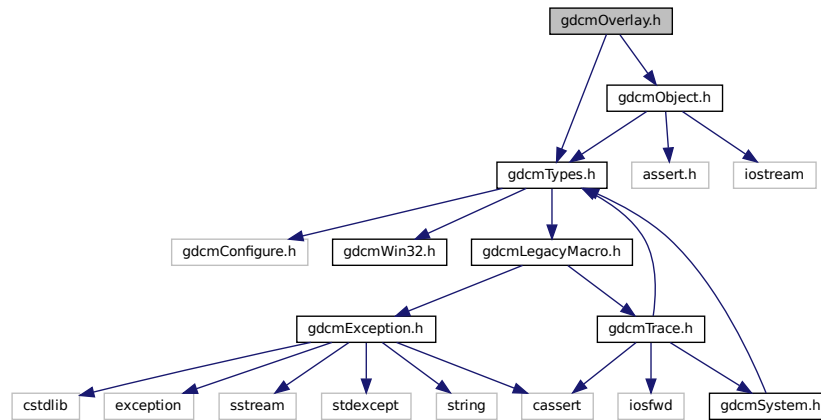

This graph shows which files directly or indirectly include this file:

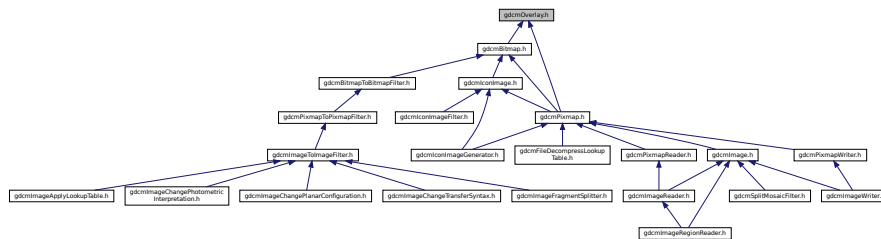

## Classes

- class `gdcm::Overlay`  
*Overlay class.*

## Namespaces

- `gdcm`

## 11.172 `gdcmParseException.h` File Reference

```
#include "gdcmException.h"
#include "gdcmDataElement.h"
```

Include dependency graph for gdcmParseException.h:

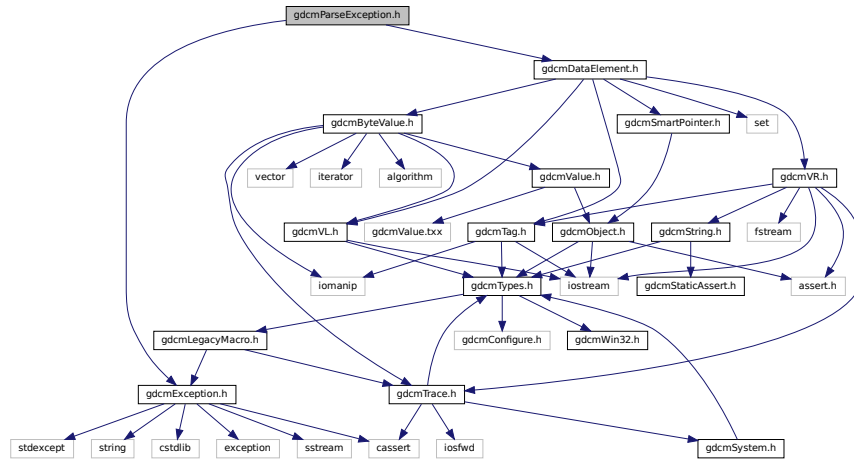

This graph shows which files directly or indirectly include this file:

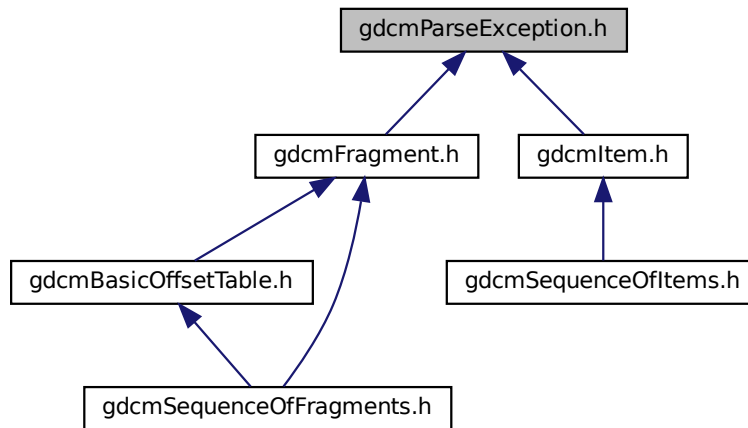

## Classes

- class [gdcm::ParseException](#)  
*ParseException* Standard exception handling object.

## Namespaces

- [gdcm](#)

## 11.173 gdcParser.h File Reference

```
#include "gdcTag.h"
#include "gdcByteBuffer.h"
#include <fstream>
```

Include dependency graph for gdcParser.h:

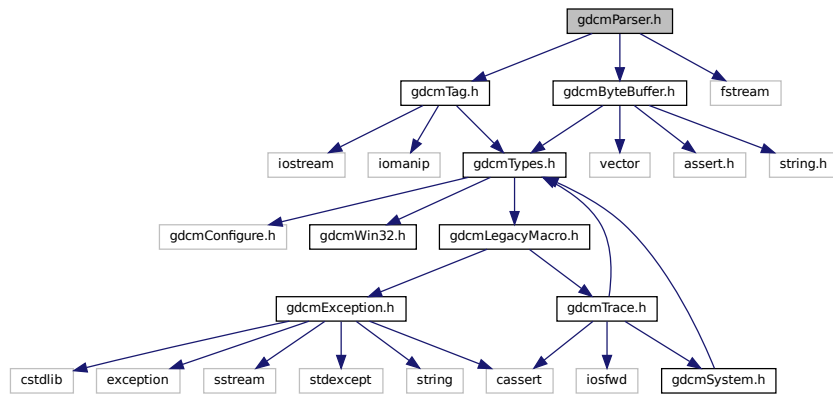

### Classes

- class [gdc::Parser](#)  
*Parser ala XML\_Parser from expat (SAX)*

### Namespaces

- [gdc](#)

## 11.174 gdcPatient.h File Reference

```
#include "gdcTypes.h"
#include "gdcStudy.h"
```



Include dependency graph for gdcMPatient.h:

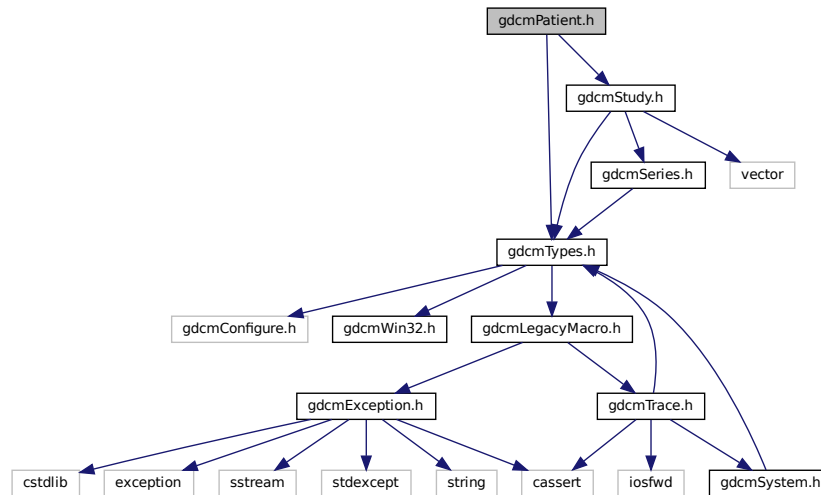

## Classes

- class [gdcM::Patient](#)

*See PS 3.3 - 2007 DICOM MODEL OF THE REAL-WORLD, p 54.*

## Namespaces

- [gdcM](#)

## 11.175 gdcMPDataTFPDU.h File Reference

```

#include "gdcMTypes.h"
#include "gdcMPresentationDataValue.h"
#include "gdcMBasePDU.h"
#include <limits>

```

Include dependency graph for `gdcmPDataTFPDU.h`:

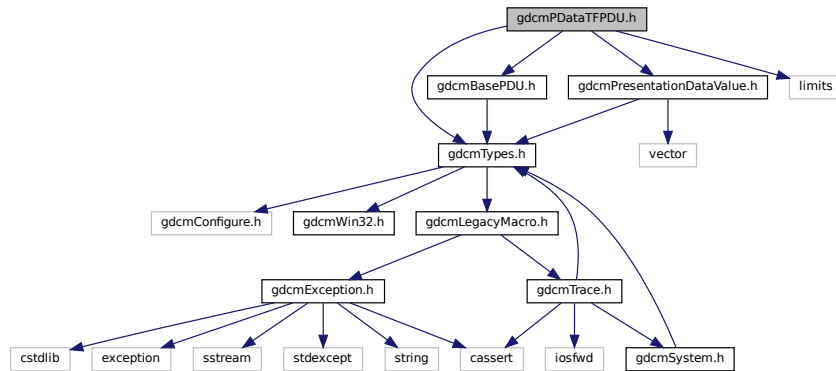

## Classes

- class `gdcm::network::PDataTFPDU`  
*PDataTFPDU*.

## Namespaces

- `gdcm`
- `gdcm::network`

## 11.176 gdcmPDBElement.h File Reference

```

#include "gdcmTag.h"
#include "gdcmVM.h"
#include "gdcmVR.h"
#include "gdcmByteValue.h"
#include "gdcmSmartPointer.h"

```

Include dependency graph for `gdcmPDBElement.h`:

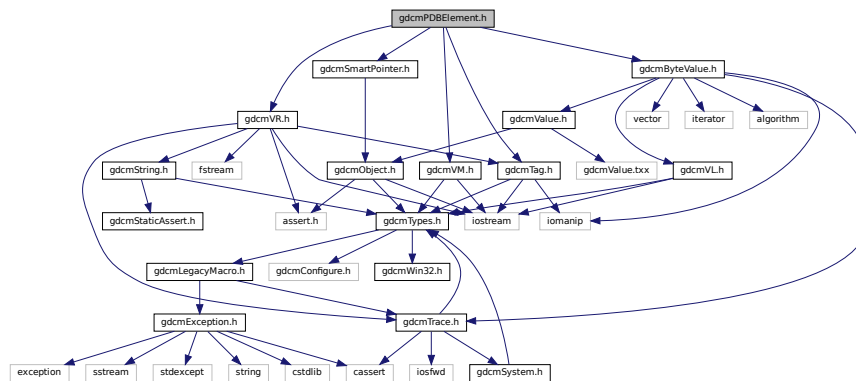

This graph shows which files directly or indirectly include this file:

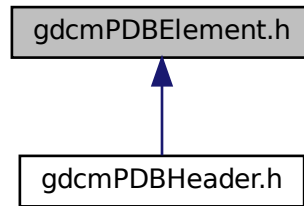

## Classes

- class [gdcnPDBElement](#)  
Class to represent a PDB *Element*.

## Namespaces

- [gdcnP](#)

## Functions

- std::ostream & [gdcnP::operator<<](#) (std::ostream &os, const PDBElement &val)

## 11.177 gdcnPDBHeader.h File Reference

```
#include "gdcnPTypes.h"
#include "gdcnPDataSet.h"
#include "gdcnPDBElement.h"
```

Include dependency graph for gdcnPDBHeader.h:

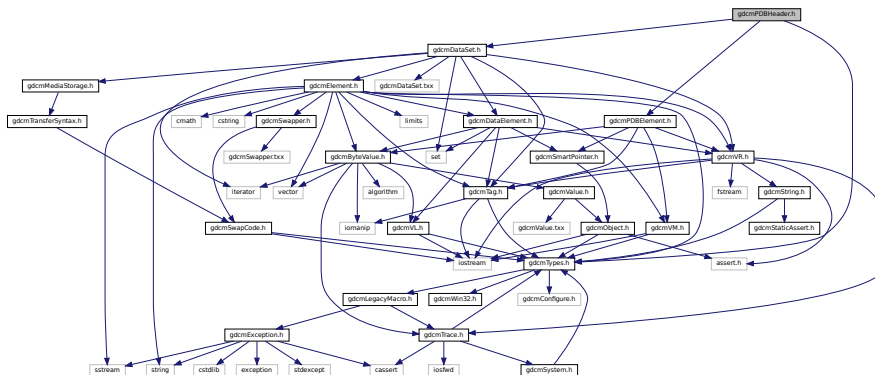

## Classes

- class [gdcm::PDBHeader](#)  
Class for *PDBHeader*.

## Namespaces

- [gdcm](#)

## Functions

- `std::ostream & gdcm::operator<< (std::ostream &os, const PDBHeader &d)`

## 11.178 gdcmPDFCodec.h File Reference

```
#include "gdcmCodec.h"
```

Include dependency graph for `gdcmPDFCodec.h`:

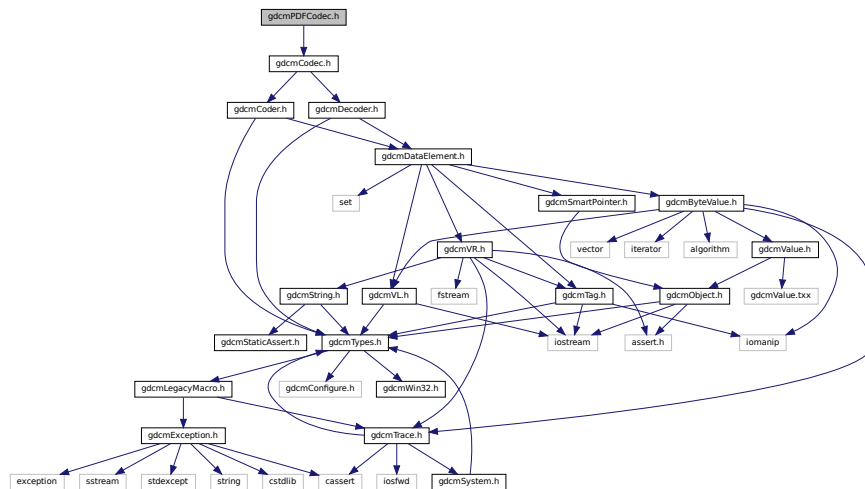

## Classes

- class [gdcm::PDFCodec](#)  
*PDFCodec* class.

## Namespaces

- [gdcm](#)

## 11.179 gdcmPDUFactory.h File Reference

```
#include "gdcmTypes.h"
#include "gdcmNetworkEvents.h"
#include "gdcmULConnection.h"
#include "gdcmPresentationDataValue.h"
```

Include dependency graph for gdcmPDUFactory.h:

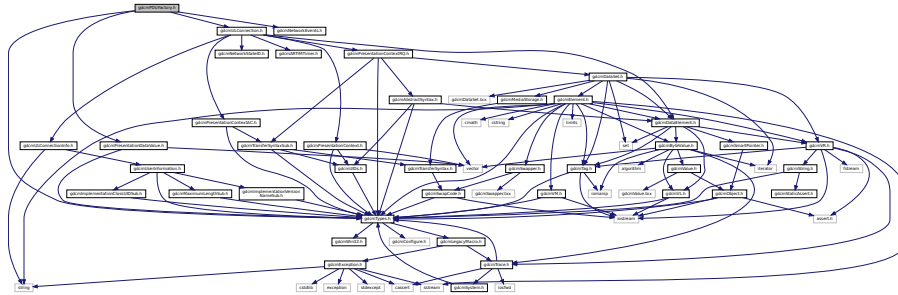

### Classes

- class [gdcm::network::PDUFactory](#)  
*PDUFactory* basically, given an initial byte, construct the.

### Namespaces

- [gdcm](#)
- [gdcm::network](#)

## 11.180 gdcmPersonName.h File Reference

```
#include "gdcmTypes.h"
#include <vector>
#include <algorithm>
#include <string.h>
```

Include dependency graph for gdcmPersonName.h:

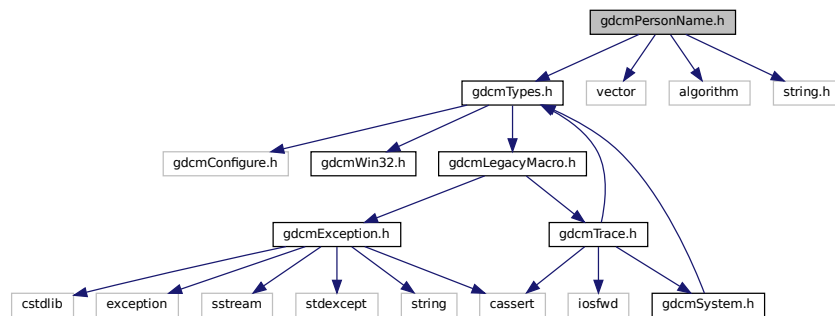

## Classes

- class [gdcm::PersonName](#)  
*PersonName* class.

## Namespaces

- [gdcm](#)

## 11.181 gdcmPGXCodec.h File Reference

```
#include "gdcmImageCodec.h"
```

Include dependency graph for gdcmPGXCodec.h:

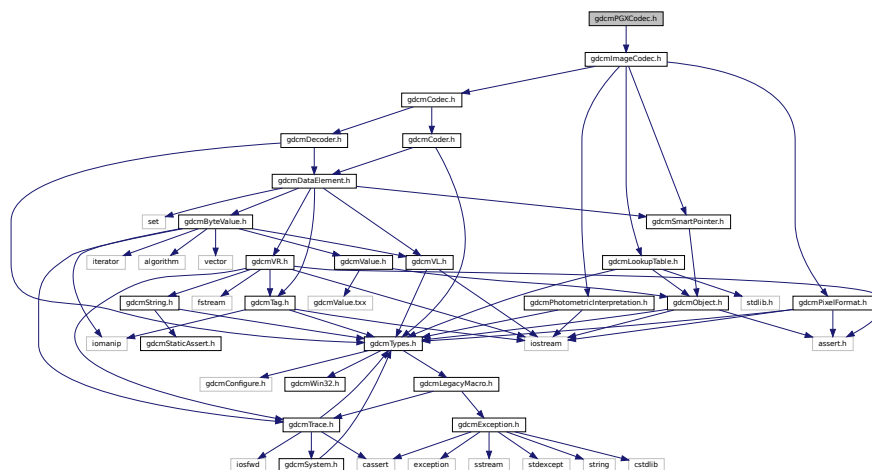

## Classes

- class [gdcm::PGXCodec](#)  
*Class to do PGX.*

## Namespaces

- [gdcm](#)

## 11.182 gdcmPhotometricInterpretation.h File Reference

```
#include "gdcmTypes.h"
```

```
#include <iostream>
```

Include dependency graph for gdcmPhotometricInterpretation.h:

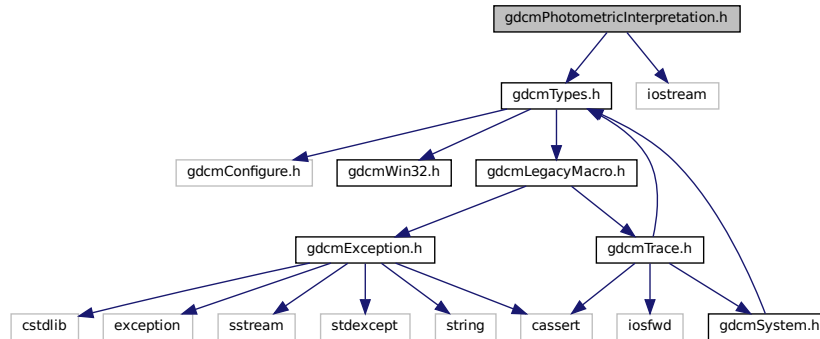

This graph shows which files directly or indirectly include this file:



### Classes

- class [gdcm::PhotometricInterpretation](#)  
Class to represent an *PhotometricInterpretation*.

### Namespaces

- [gdcm](#)

### Functions

- `std::ostream & gdcm::operator<< (std::ostream &os, const PhotometricInterpretation &val)`

## 11.183 gdcmPixelFormat.h File Reference

```
#include "gdcmTypes.h"
```

```
#include <iostream>
```

```
#include <assert.h>
```

Include dependency graph for gdcmPixelFormat.h:

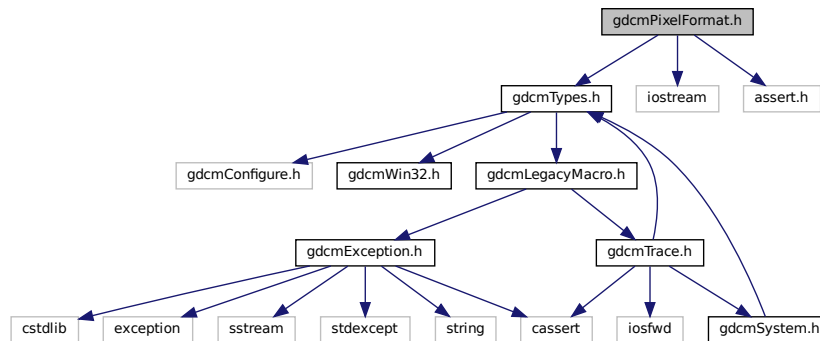

This graph shows which files directly or indirectly include this file:

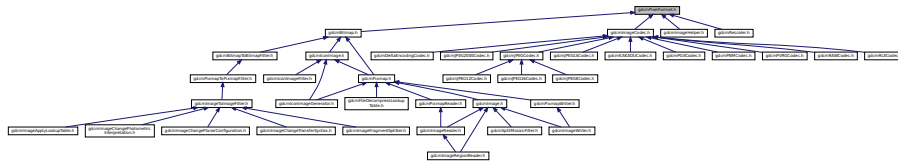

### Classes

- class [gdcm::PixelFormat](#)  
*PixelFormat.*

### Namespaces

- [gdcm](#)

### Functions

- `std::ostream & gdcm::operator<< (std::ostream &os, const PixelFormat &pf)`



## 11.184 gdcmPixmap.h File Reference

```
#include "gdcmBitmap.h"
#include "gdcmCurve.h"
#include "gdcmIconImage.h"
#include "gdcmOverlay.h"
Include dependency graph for gdcmPixmap.h:
```

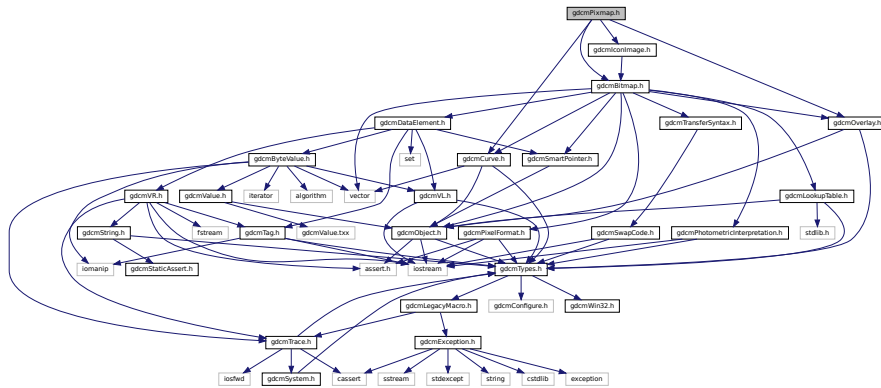

This graph shows which files directly or indirectly include this file:

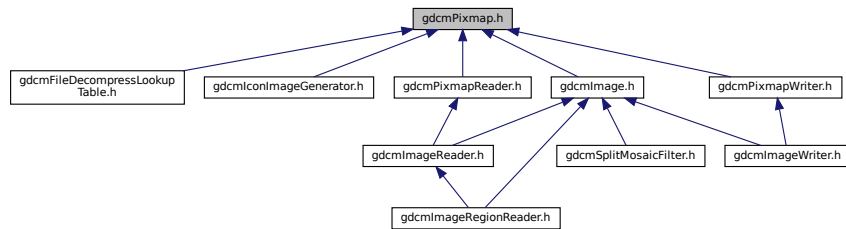

### Classes

- class [gdcm::Pixmap](#)  
*Pixmap* class.

### Namespaces

- [gdcm](#)

### 11.185 gdcmPixmapReader.h File Reference

```
#include "gdcmReader.h"
#include "gdcmPixmap.h"
```

Include dependency graph for gdcmPixmapReader.h:

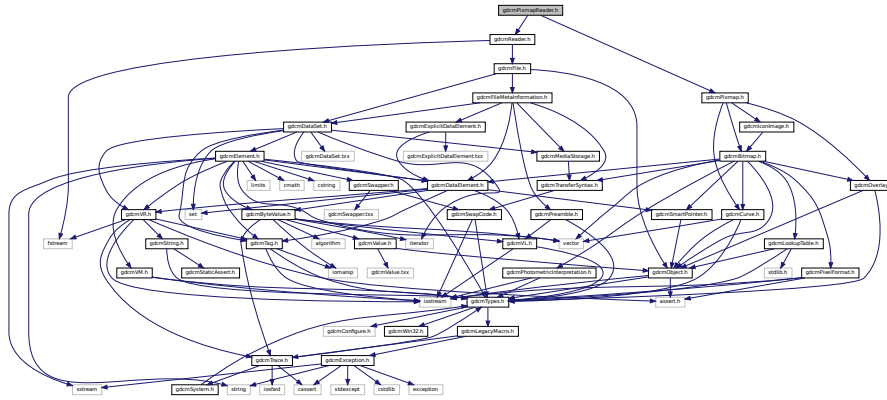

This graph shows which files directly or indirectly include this file:

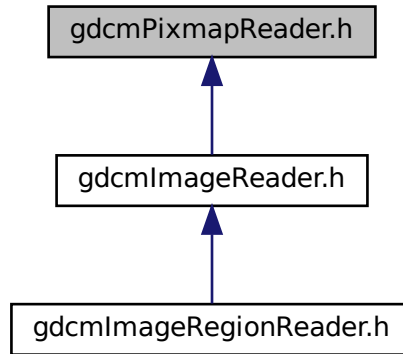

#### Classes

- class [gdcm::PixmapReader](#)  
*PixmapReader.*

#### Namespaces

- [gdcm](#)

## 11.186 gdcmPixmapToPixmapFilter.h File Reference

```
#include "gdcmBitmapToBitmapFilter.h"
```

Include dependency graph for gdcmPixmapToPixmapFilter.h:

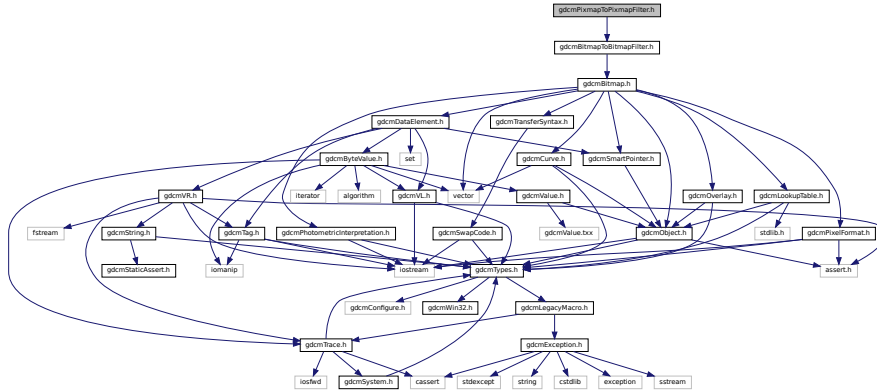

This graph shows which files directly or indirectly include this file:

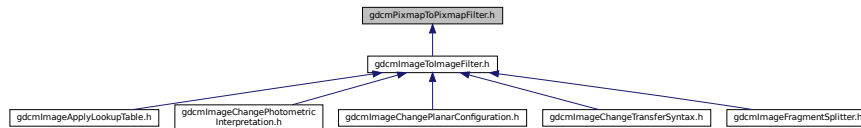

### Classes

- class [gdcm::PixmapToPixmapFilter](#)  
*PixmapToPixmapFilter* class.

### Namespaces

- [gdcm](#)

## 11.187 gdcmPixmapWriter.h File Reference

```
#include "gdcmWriter.h"
```

```
#include "gdcmPixmap.h"
```

Include dependency graph for `gdcmPixmapWriter.h`:

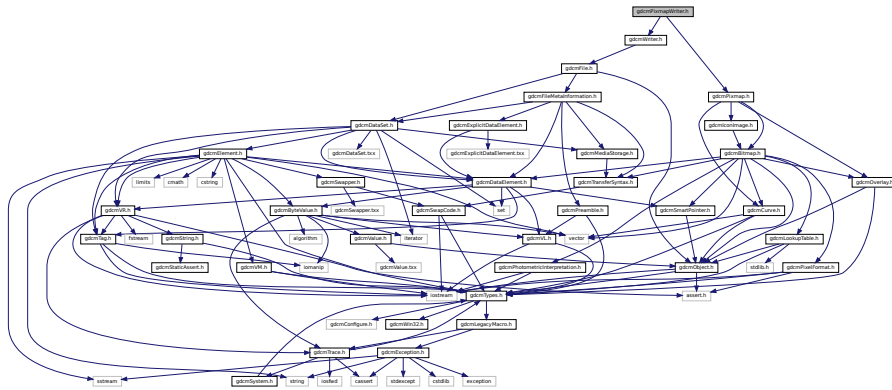

This graph shows which files directly or indirectly include this file:

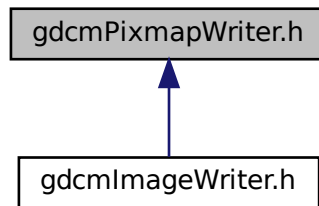

## Classes

- class `gdcm::PixmapWriter`  
*PixmapWriter.*

## Namespaces

- `gdcm`

## 11.188 gdcnPnmCodec.h File Reference

```
#include "gdcmImageCodec.h"
```

Include dependency graph for gdcnPnmCodec.h:

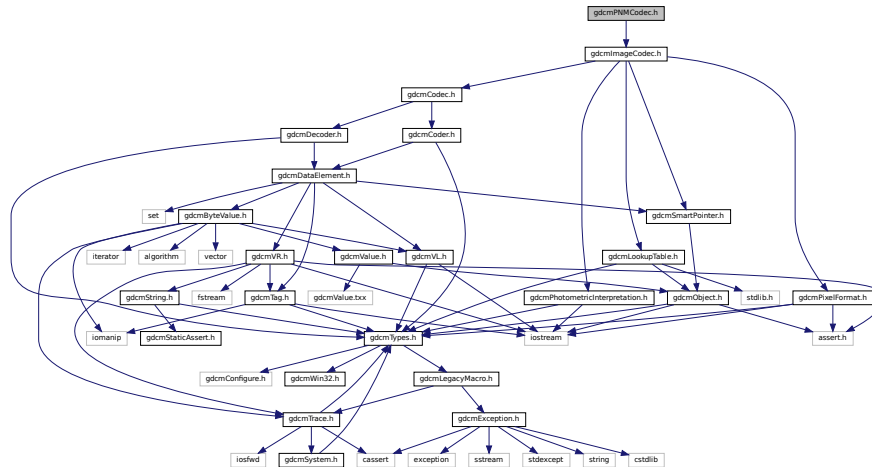

### Classes

- class [gdcm::PnmCodec](#)  
*Class to do PNM.*

### Namespaces

- [gdcm](#)

## 11.189 gdcmPreamble.h File Reference

```
#include "gdcmTypes.h"
```

```
#include "gdcmVL.h"
```

Include dependency graph for `gdcmPreamble.h`:

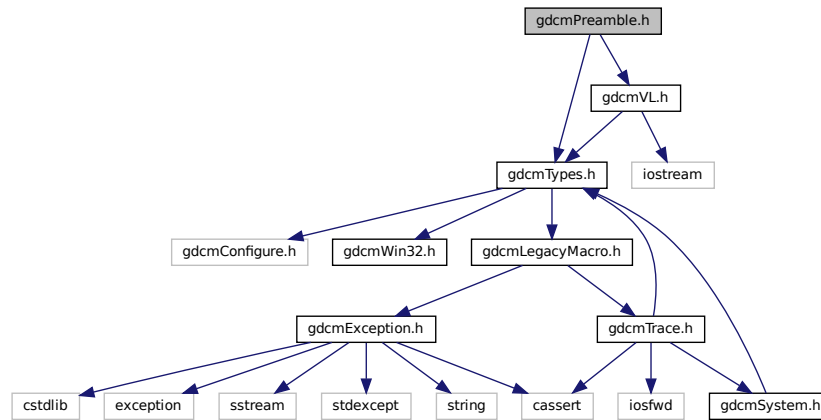

This graph shows which files directly or indirectly include this file:

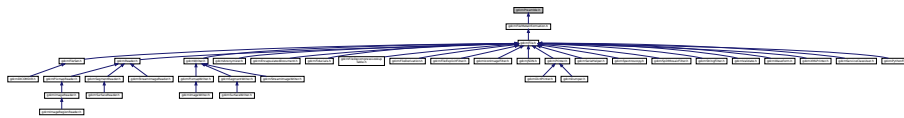

## Classes

- class [gdcm::Preamble](#)  
*DICOM Preamble (Part 10)*

## Namespaces

- [gdcm](#)

## Functions

- `std::ostream & gdcm::operator<< (std::ostream &os, const Preamble &val)`

## 11.190 gdcmPresentationContext.h File Reference

```
#include "gdcmTypes.h"
```

```
#include "gdcmUIDs.h"
```

```
#include <vector>
```

Include dependency graph for gdcmPresentationContext.h:

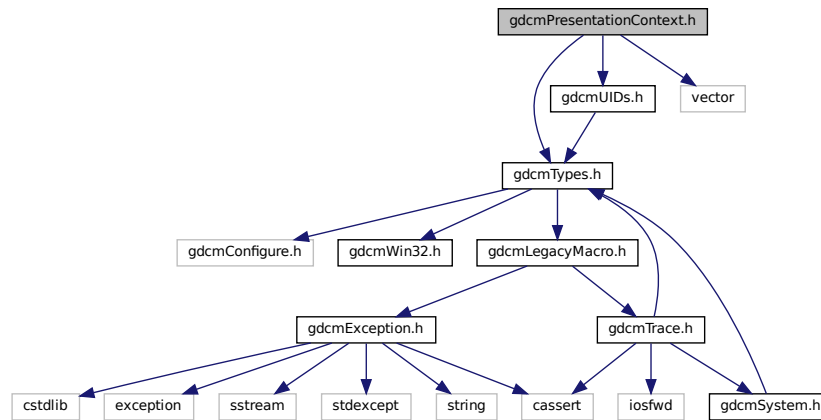

This graph shows which files directly or indirectly include this file:

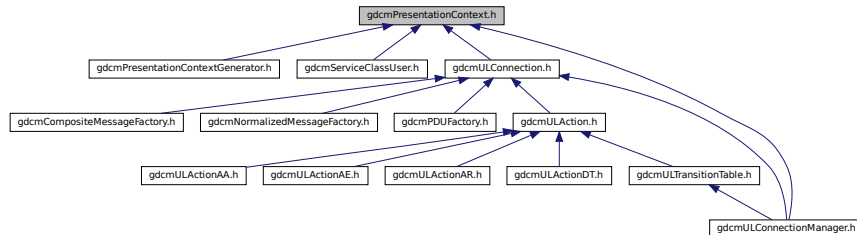

### Classes

- class [gdcm::PresentationContext](#)  
*PresentationContext.*

### Namespaces

- [gdcm](#)

## 11.191 gdcmPresentationContextAC.h File Reference

```
#include "gdcmTypes.h"
#include "gdcmTransferSyntaxSub.h"
Include dependency graph for gdcmPresentationContextAC.h:
```

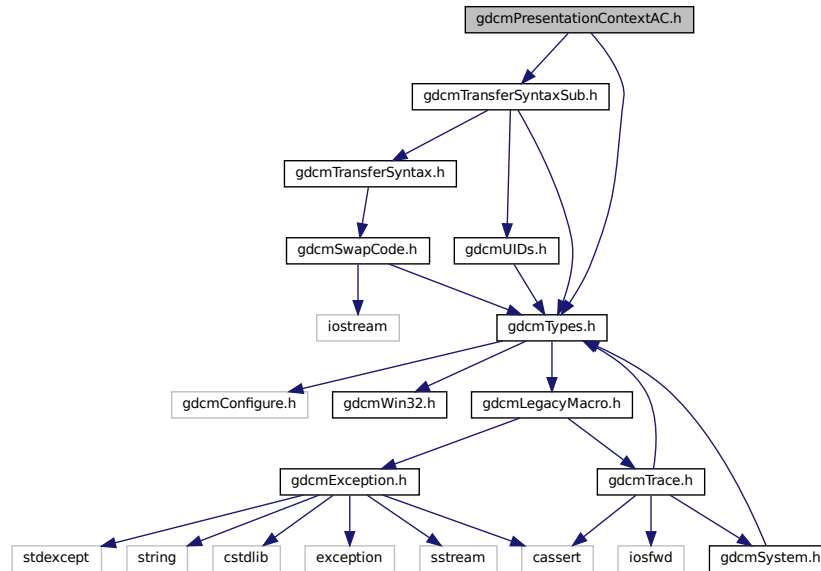

This graph shows which files directly or indirectly include this file:

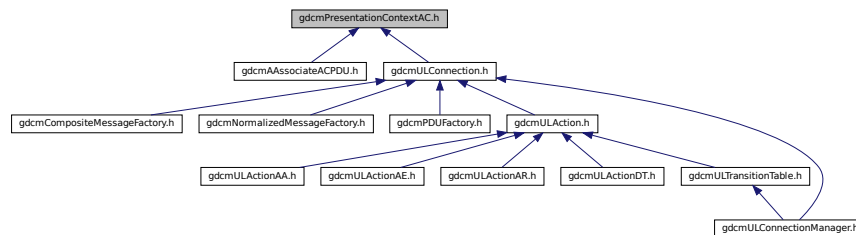

### Classes

- class [gdcm::network::PresentationContextAC](#)  
*PresentationContextAC.*

### Namespaces

- [gdcm](#)
- [gdcm::network](#)



## 11.192 gdcmPresentationContextGenerator.h File Reference

```
#include "gdcmDirectory.h"
#include "gdcmPresentationContext.h"
Include dependency graph for gdcmPresentationContextGenerator.h:
```

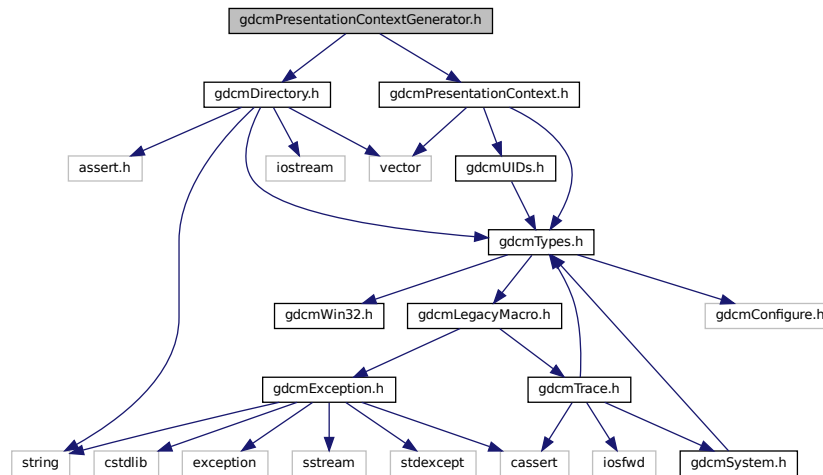

### Classes

- class [gdcm::PresentationContextGenerator](#)  
*PresentationContextGenerator.*

### Namespaces

- [gdcm](#)

## 11.193 gdcmPresentationContextRQ.h File Reference

```
#include "gdcmTypes.h"
#include "gdcmAbstractSyntax.h"
#include "gdcmTransferSyntaxSub.h"
```

```
#include "gdcmDataSet.h"
Include dependency graph for gdcmPresentationContextRQ.h:
```

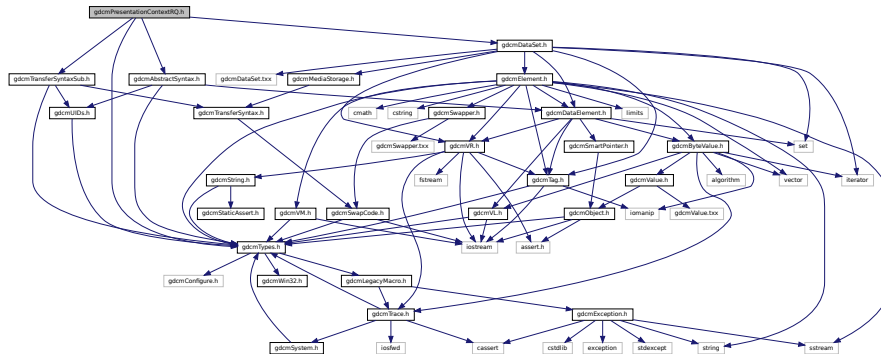

This graph shows which files directly or indirectly include this file:

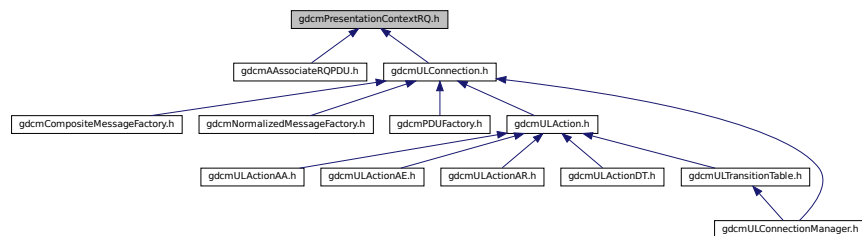

## Classes

- class [gdcm::network::PresentationContextRQ](#)  
*PresentationContextRQ.*

## Namespaces

- [gdcm](#)
- [gdcm::network](#)

## 11.194 gdcmPresentationDataValue.h File Reference

```
#include "gdcmTypes.h"
#include <vector>
```

Include dependency graph for gdcmPresentationDataValue.h:

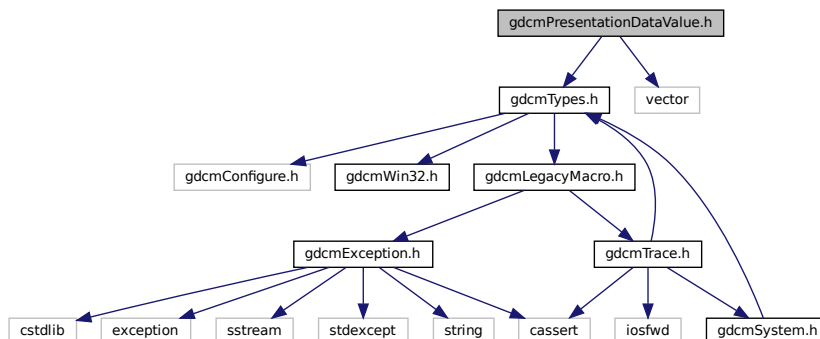

This graph shows which files directly or indirectly include this file:

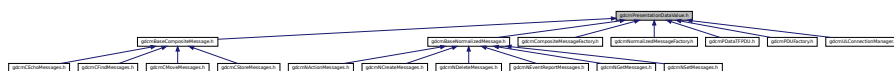

## Classes

- class [gdcm::network::PresentationDataValue](#)  
*PresentationDataValue.*

## Namespaces

- [gdcm](#)
- [gdcm::network](#)

## 11.195 gdcPrinter.h File Reference

```
#include "gdcmFile.h"
#include "gdcmDataElement.h"
```

Include dependency graph for `gdcMPrinter.h`:

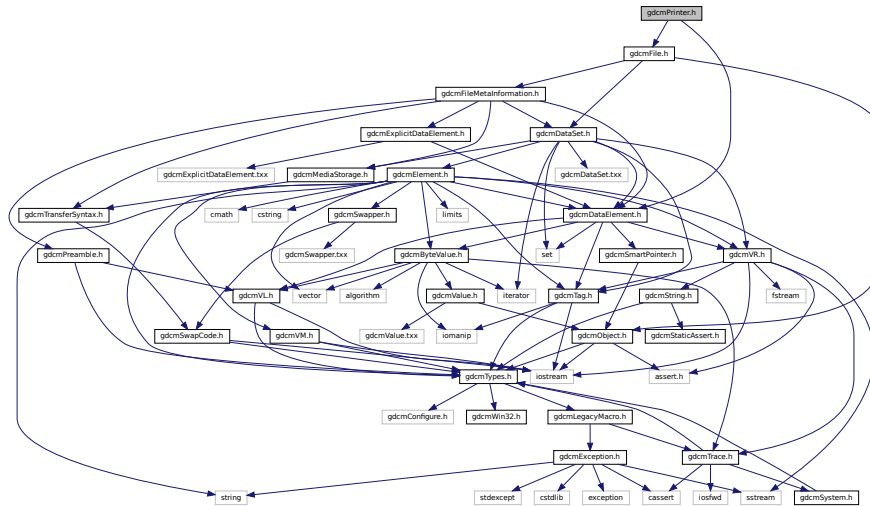

This graph shows which files directly or indirectly include this file:

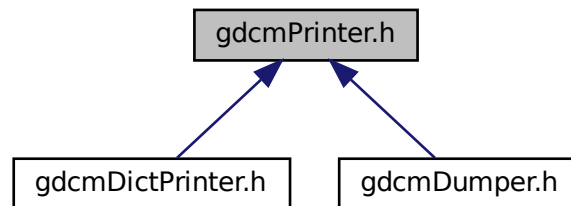

## Classes

- class `gdcM::Printer`  
*Printer* class.

## Namespaces

- `gdcM`

## 11.196 gdcmPrivateTag.h File Reference

```

#include "gdcmTag.h"
#include "gdcmVR.h"
#include "gdcmDataElement.h"
#include <iostream>
#include <iomanip>
#include <string>
#include <algorithm>
#include <string.h>
#include <ctype.h>

```

Include dependency graph for gdcmPrivateTag.h:

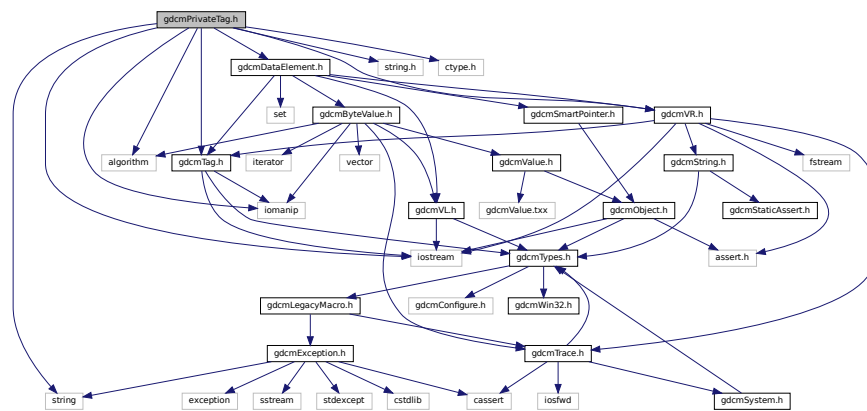

This graph shows which files directly or indirectly include this file:

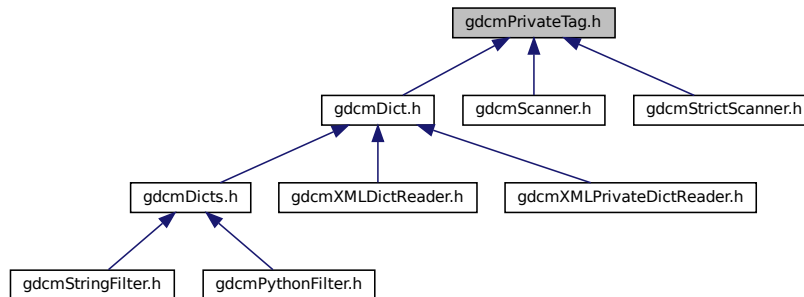

### Classes

- class [gdcm::PrivateTag](#)

*Class to represent a Private DICOM Data [Element](#) ([Attribute](#)) [Tag](#) ([Group](#), [Element](#), [Owner](#))*

## Namespaces

- [gdc](#)

## Functions

- `std::ostream & gdc::operator<< (std::ostream &os, const PrivateTag &val)`

## 11.197 gdcmProgressEvent.h File Reference

```
#include "gdcmEvent.h"
```

```
#include "gdcmTag.h"
```

Include dependency graph for gdcmProgressEvent.h:

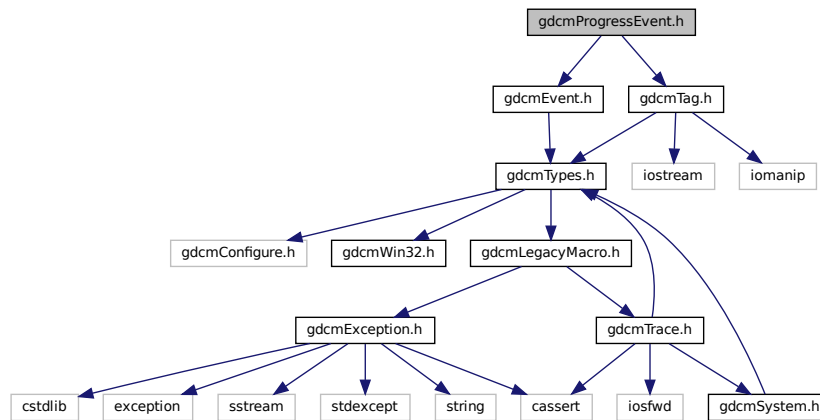

## Classes

- class [gdc::ProgressEvent](#)  
*ProgressEvent.*

## Namespaces

- [gdc](#)

## 11.198 gdcmPVRGCodec.h File Reference

```
#include "gdcmImageCodec.h"
```

Include dependency graph for gdcmPVRGCodec.h:

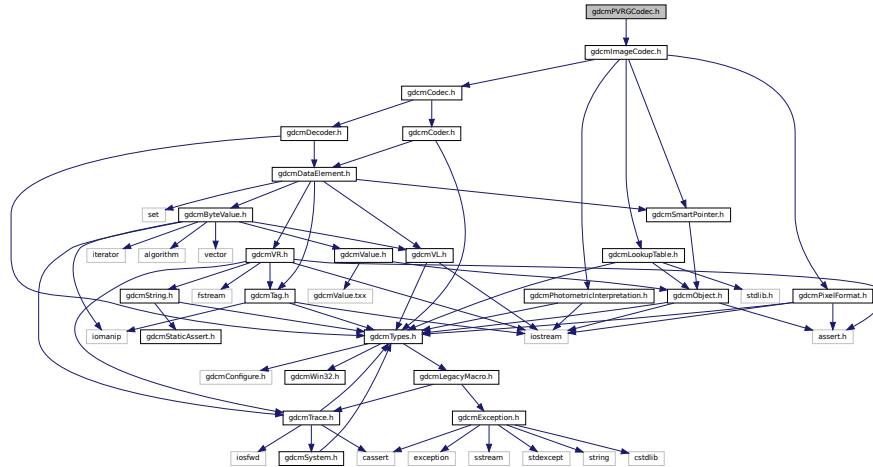

### Classes

- class [gdcm::PVRGCodec](#)  
*PVRGCodec.*

### Namespaces

- [gdcm](#)

## 11.199 gdcmPythonFilter.h File Reference

```
#include <Python.h>
```

```
#include "gdcmDataElement.h"
```

```
#include "gdcmDicts.h"
```

```
#include "gdcmFile.h"
```

Include dependency graph for gdcmPythonFilter.h:

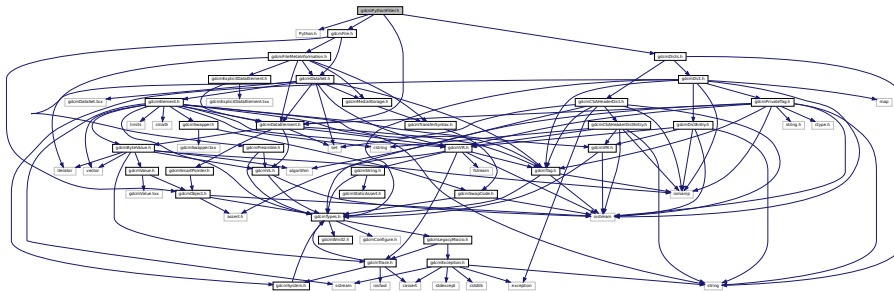

## Classes

- class [gdcmm::PythonFilter](#)

*PythonFilter PythonFilter* is the class that make *gdcmm2.x* looks more like *gdcmm1* and transform the binary blob contained in a *DataElement* into a string, typically this is a nice feature to have for wrapped language.

## Namespaces

- [gdcmm](#)

## 11.200 gdcmmQueryBase.h File Reference

```
#include "gdcmmTag.h"
#include "gdcmmDataElement.h"
#include <vector>
```

Include dependency graph for `gdcmmQueryBase.h`:

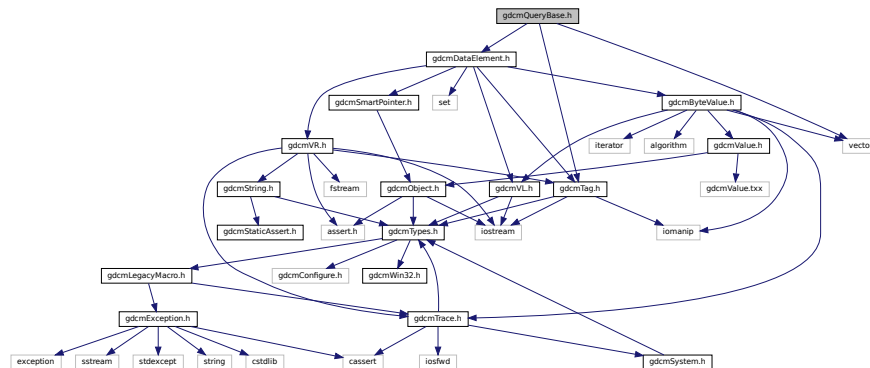

This graph shows which files directly or indirectly include this file:

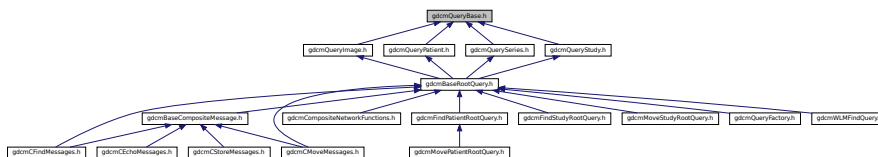

## Classes

- class [gdcmm::QueryBase](#)  
*QueryBase.*



## Namespaces

- [gdcM](#)

## Enumerations

- enum [gdcM::ERootType](#) {  
[gdcM::ePatientRootType](#) ,  
[gdcM::eStudyRootType](#) }

## 11.201 gdcMQueryFactory.h File Reference

```
#include "gdcMBaseRootQuery.h"
Include dependency graph for gdcMQueryFactory.h:
```

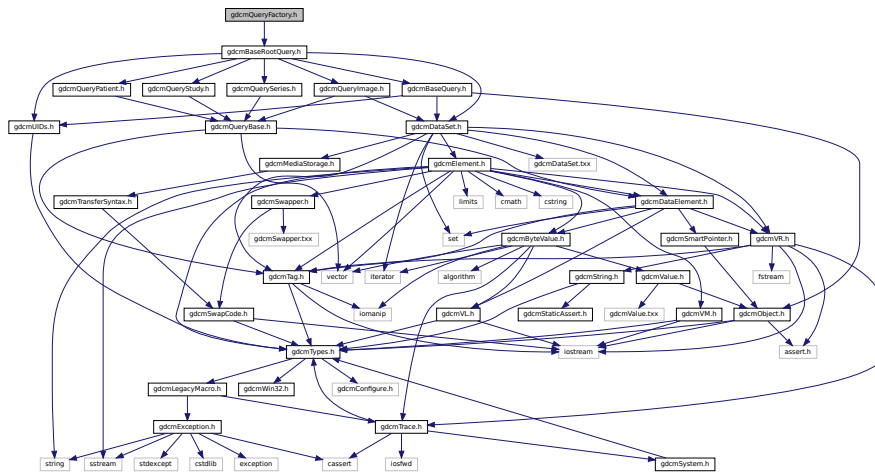

## Classes

- class [gdcM::QueryFactory](#)  
*QueryFactory.h.*

## Namespaces

- [gdcM](#)

## Enumerations

- enum `gdcM::ECharSet` {
  - `gdcM::eLatin1 = 0`,
  - `gdcM::eLatin2`,
  - `gdcM::eLatin3`,
  - `gdcM::eLatin4`,
  - `gdcM::eCyrillic`,
  - `gdcM::eArabic`,
  - `gdcM::eGreek`,
  - `gdcM::eHebrew`,
  - `gdcM::eLatin5`,
  - `gdcM::eJapanese`,
  - `gdcM::eThai`,
  - `gdcM::eJapaneseKanjiMultibyte`,
  - `gdcM::eJapaneseSupplementaryKanjiMultibyte`,
  - `gdcM::eKoreanHangulHanjaMultibyte`,
  - `gdcM::eUTF8`,
  - `gdcM::eGB18030`

## 11.202 gdcMQueryImage.h File Reference

```
#include "gdcMQueryBase.h"
```

```
#include "gdcMDataSet.h"
```

Include dependency graph for `gdcMQueryImage.h`:

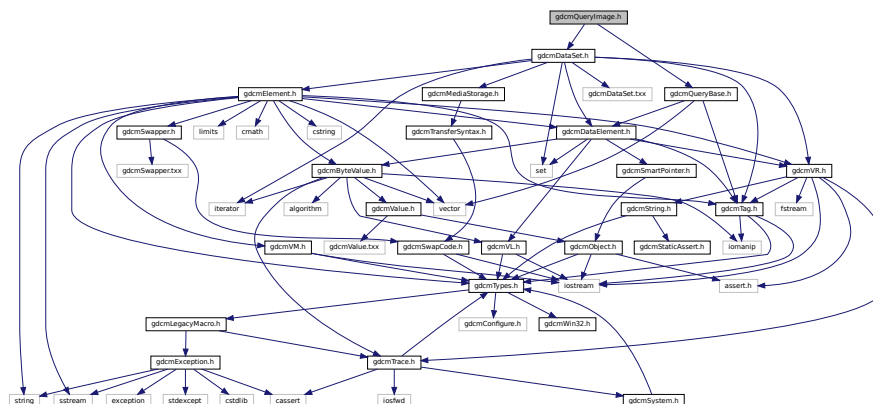

This graph shows which files directly or indirectly include this file:



## Classes

- class [gdcM::QueryImage](#)  
*QueryImage.*

## Namespaces

- [gdcM](#)

## 11.203 gdcMQueryPatient.h File Reference

```
#include "gdcMQueryBase.h"
```

Include dependency graph for gdcMQueryPatient.h:

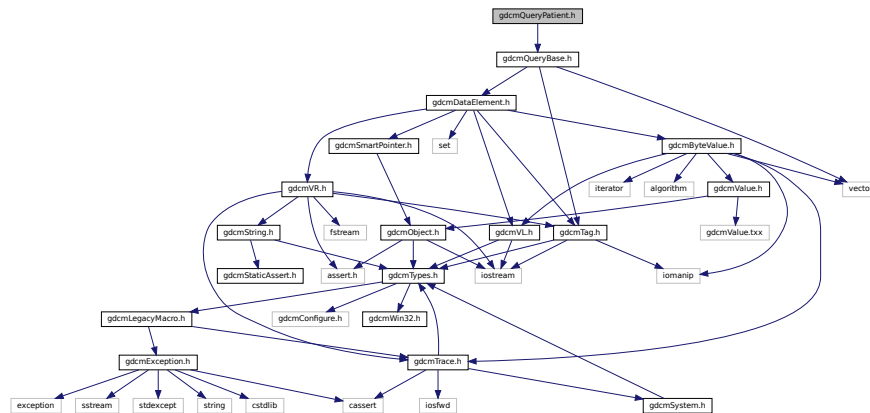

This graph shows which files directly or indirectly include this file:



## Classes

- class [gdcM::QueryPatient](#)  
*QueryPatient.*

## Namespaces

- [gdcM](#)

## 11.204 gdcMQuerySeries.h File Reference

```
#include "gdcMQueryBase.h"
```

Include dependency graph for gdcMQuerySeries.h:

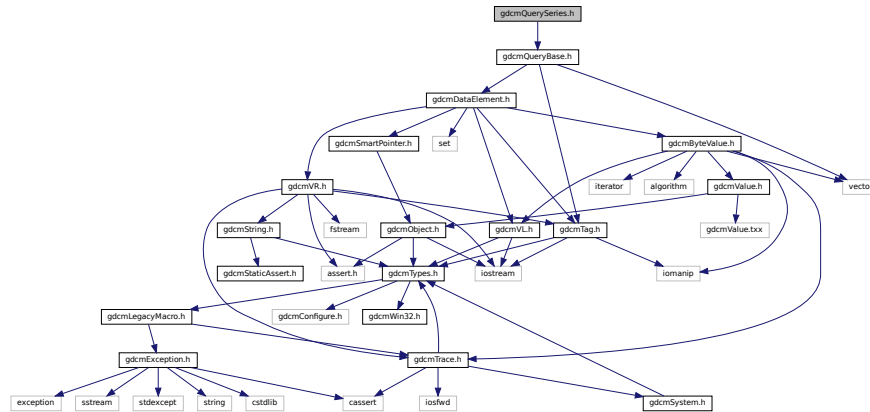

This graph shows which files directly or indirectly include this file:



### Classes

- class [gdcM::QuerySeries](#)  
*QuerySeries.*

### Namespaces

- [gdcM](#)

## 11.205 gdcQueryStudy.h File Reference

```
#include "gdcQueryBase.h"
```

Include dependency graph for gdcQueryStudy.h:

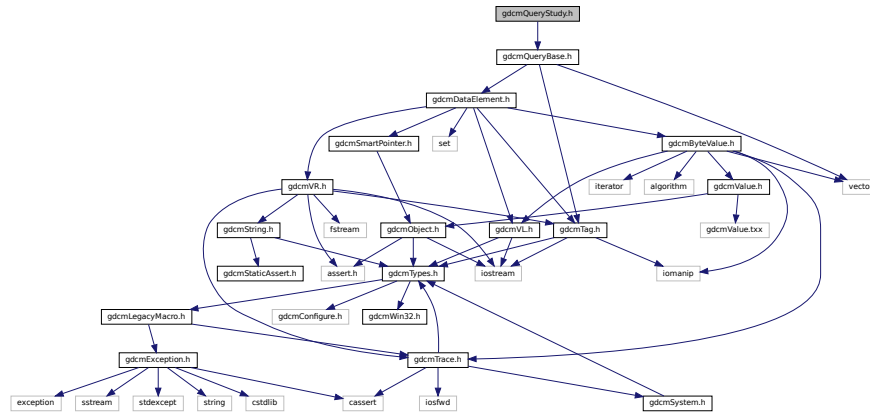

This graph shows which files directly or indirectly include this file:



### Classes

- class [gdcm::QueryStudy](#)  
*QueryStudy.h*

### Namespaces

- [gdcm](#)

## 11.206 gdcmlRAWCodec.h File Reference

```
#include "gdcmlImageCodec.h"
```

Include dependency graph for gdcmlRAWCodec.h:

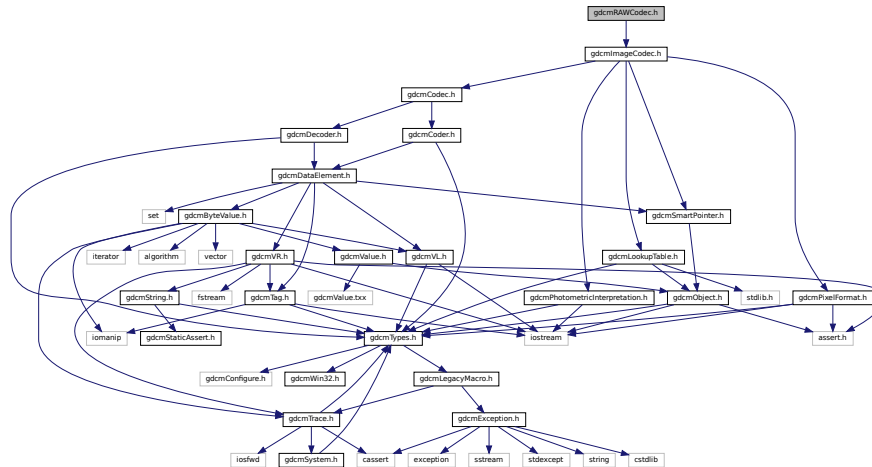

### Classes

- class [gdcm::RAWCodec](#)  
*RAWCodec* class.

### Namespaces

- [gdcm](#)

## 11.207 gdcmReader.h File Reference

```
#include "gdcmFile.h"
```

```
#include <fstream>
```

Include dependency graph for gdcmReader.h:

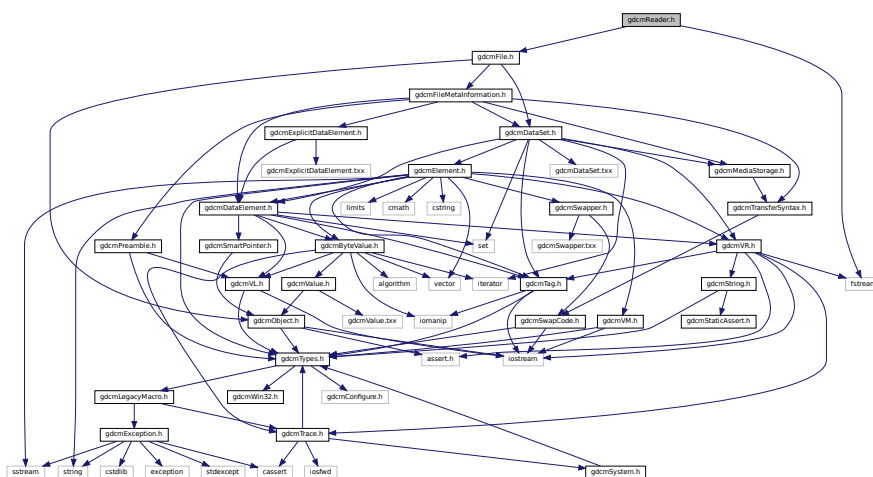

This graph shows which files directly or indirectly include this file:

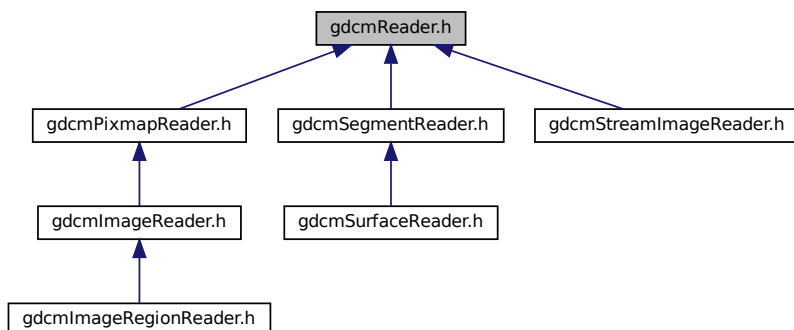

## Classes

- class [gdcm::Reader](#)  
*Reader ala DOM (Document Object Model)*

## Namespaces

- [gdcm](#)

## 11.208 gdcmRegion.h File Reference

```
#include "gdcmTypes.h"
```

```
#include <vector>
```

```
#include <iostream>
```

Include dependency graph for gdcmRegion.h:

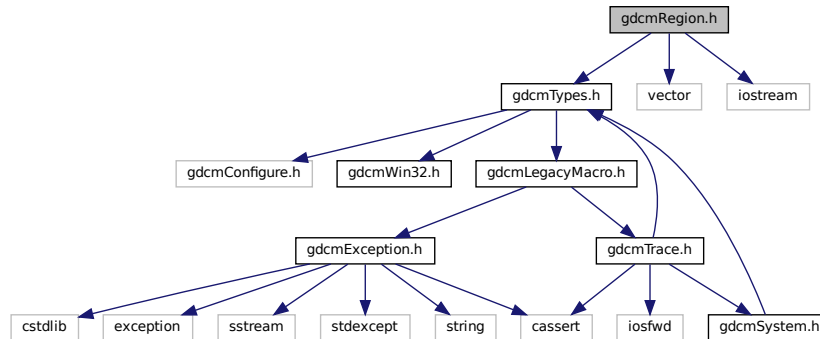

This graph shows which files directly or indirectly include this file:

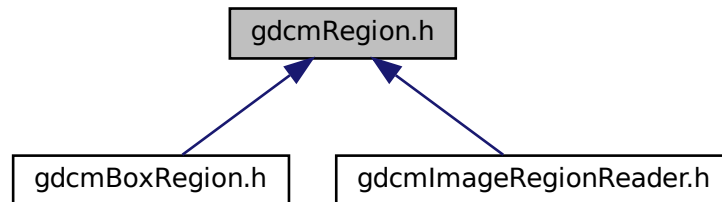

### Classes

- class [gdcm::Region](#)  
*Class for manipulation region.*

### Namespaces

- [gdcm](#)



## Functions

- `std::ostream & gdcM::operator<<` (`std::ostream &os`, `const Region &r`)

## 11.209 gdcMRescaler.h File Reference

```
#include "gdcMTypes.h"
```

```
#include "gdcMPixelFormat.h"
```

Include dependency graph for `gdcMRescaler.h`:

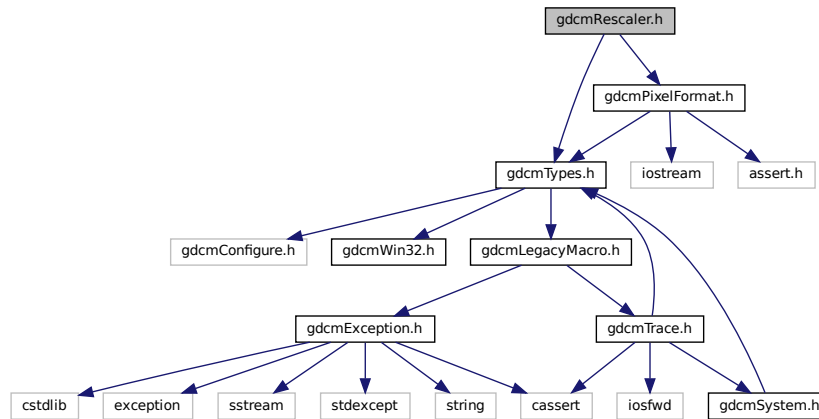

## Classes

- class `gdcM::Rescaler`  
*Rescale class.*

## Namespaces

- `gdcM`

## 11.210 gdcmlRLECodec.h File Reference

```
#include "gdcmlImageCodec.h"
```

Include dependency graph for gdcmlRLECodec.h:

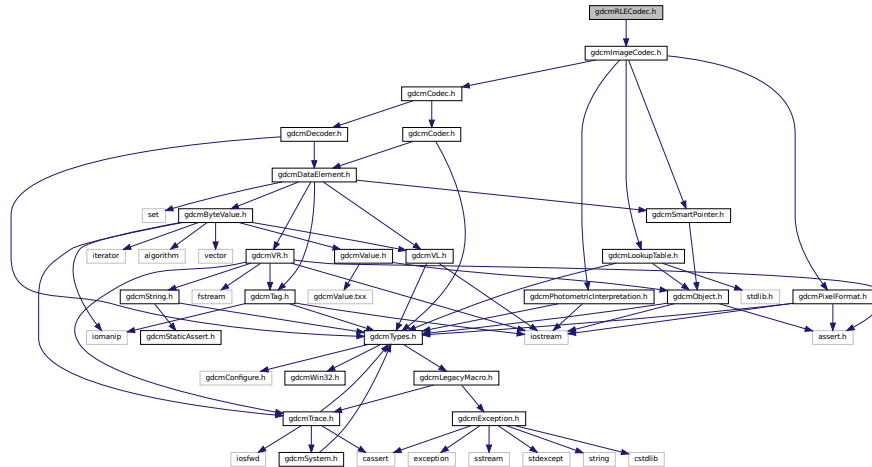

### Classes

- class [gdcml::RLECodec](#)  
*Class to do RLE.*

### Namespaces

- [gdcml](#)

## 11.211 gdcmlRoleSelectionSub.h File Reference

```
#include "gdcmlTypes.h"
```

Include dependency graph for gdcmlRoleSelectionSub.h:

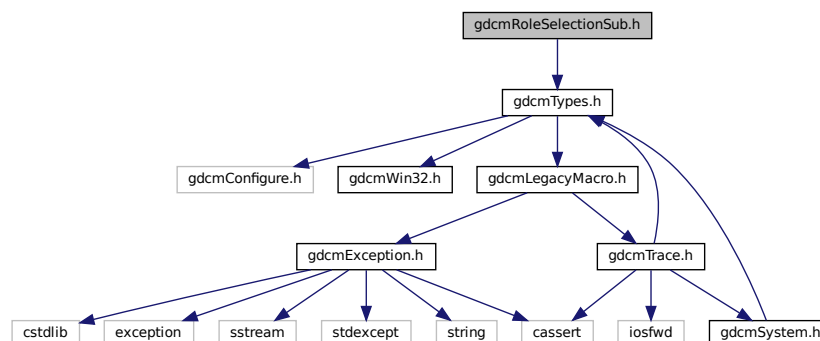

**Classes**

- class [gdcm::network::RoleSelectionSub](#)  
*RoleSelectionSub.*

**Namespaces**

- [gdcm](#)
- [gdcm::network](#)

**11.212 gdcmScanner.h File Reference**

```
#include "gdcmDirectory.h"
#include "gdcmSubject.h"
#include "gdcmTag.h"
#include "gdcmPrivateTag.h"
#include "gdcmSmartPointer.h"
#include <map>
#include <set>
#include <string>
#include <string.h>
Include dependency graph for gdcmScanner.h:
```

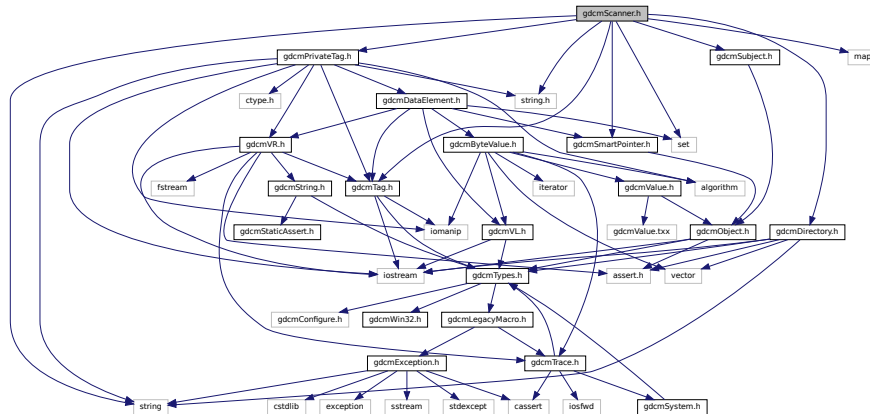

**Classes**

- struct [gdcm::Scanner::ltstr](#)
- class [gdcm::Scanner](#)  
*Scanner.*

**Namespaces**

- [gdcm](#)

## Functions

- `std::ostream & gdcmm::operator<< (std::ostream &os, const Scanner &s)`

### 11.213 gdcmmSegment.h File Reference

```
#include <vector>
#include <gdcmmObject.h>
#include <gdcmmSurface.h>
#include "gdcmmSegmentHelper.h"
Include dependency graph for gdcmmSegment.h:
```

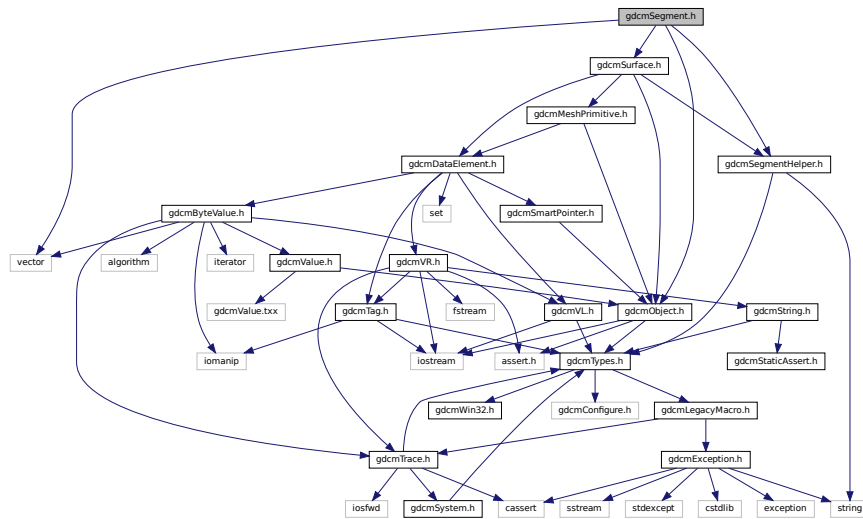

This graph shows which files directly or indirectly include this file:

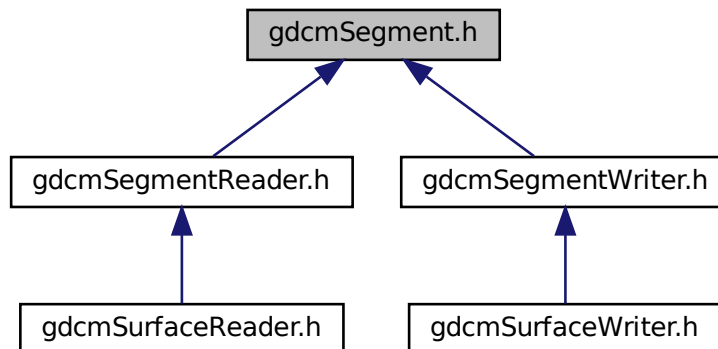

## Classes

- class [gdcm::Segment](#)  
*This class defines a segment.*

## Namespaces

- [gdcm](#)

## 11.214 gdcSegmentedPaletteColorLookupTable.h File Reference

```
#include "gdcmLookupTable.h"
```

Include dependency graph for gdcSegmentedPaletteColorLookupTable.h:

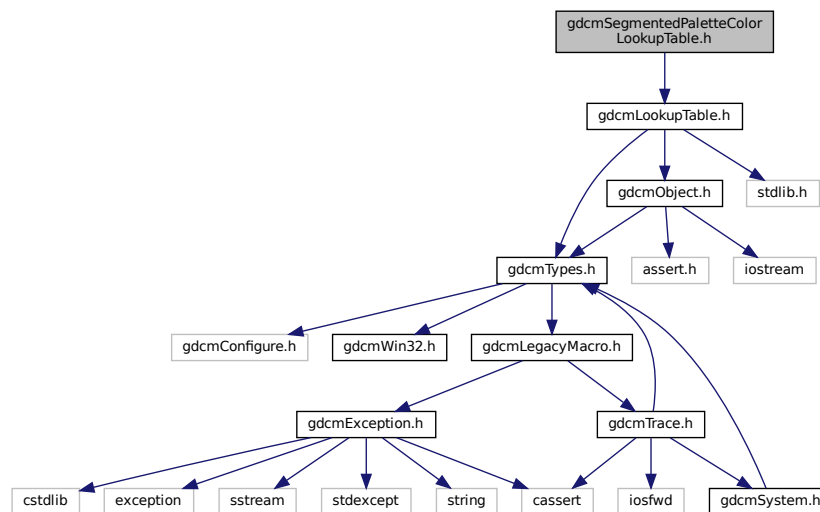

## Classes

- class [gdcm::SegmentedPaletteColorLookupTable](#)  
*SegmentedPaletteColorLookupTable class.*

## Namespaces

- [gdcm](#)

## 11.215 gdcmSegmentHelper.h File Reference

```
#include "gdcmTypes.h"
```

```
#include <string>
```

Include dependency graph for gdcmSegmentHelper.h:

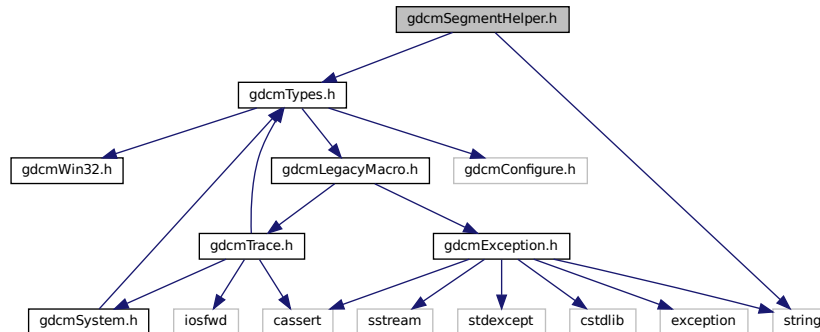

This graph shows which files directly or indirectly include this file:

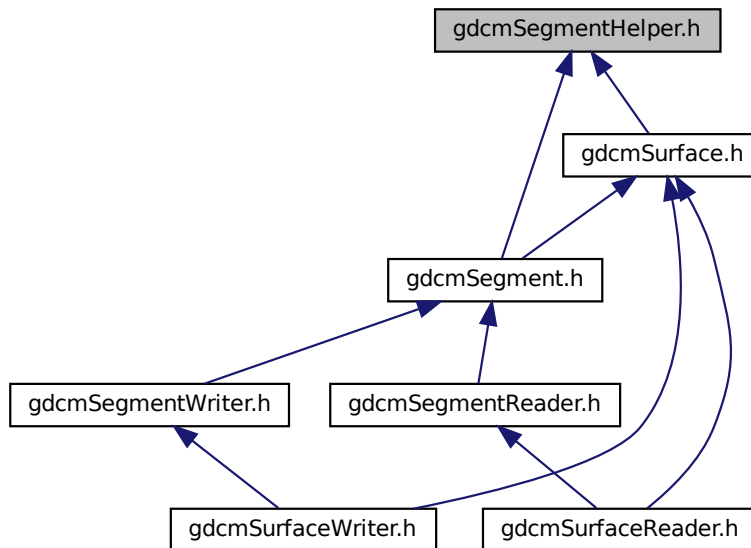

### Classes

- struct [gdcm::SegmentHelper::BasicCodedEntry](#)

*This structure defines a basic coded entry with all of its attributes.*

### Namespaces

- gdcm
- gdcm::SegmentHelper

## 11.216 gdcmSegmentReader.h File Reference

```

#include <map>
#include <gdcmReader.h>
#include <gdcmSegment.h>

```

Include dependency graph for gdcmSegmentReader.h:

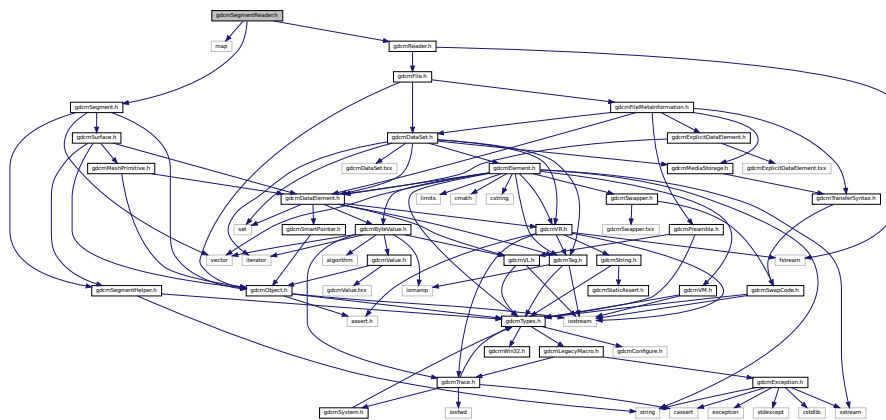

This graph shows which files directly or indirectly include this file:

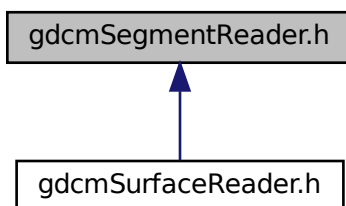

### Classes

- class [gdcm::SegmentReader](#)  
*This class defines a segment reader.*

## Namespaces

- [gdcm](#)

## 11.217 gdcmSegmentWriter.h File Reference

```
#include <gdcmWriter.h>
#include <gdcmSegment.h>
```

Include dependency graph for gdcmSegmentWriter.h:

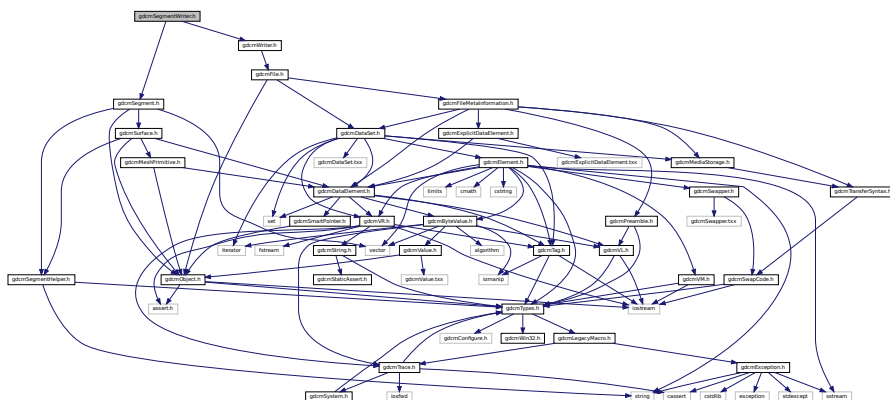

This graph shows which files directly or indirectly include this file:

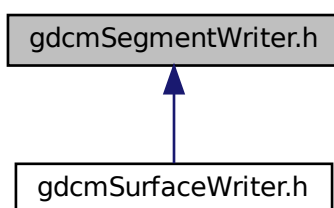

## Classes

- class [gdcm::SegmentWriter](#)  
*This class defines a segment writer.*



## Namespaces

- [gdcm](#)

## 11.218 gdcmSequenceOfFragments.h File Reference

```
#include "gdcmValue.h"
#include "gdcmVL.h"
#include "gdcmFragment.h"
#include "gdcmBasicOffsetTable.h"
```

Include dependency graph for gdcmSequenceOfFragments.h:

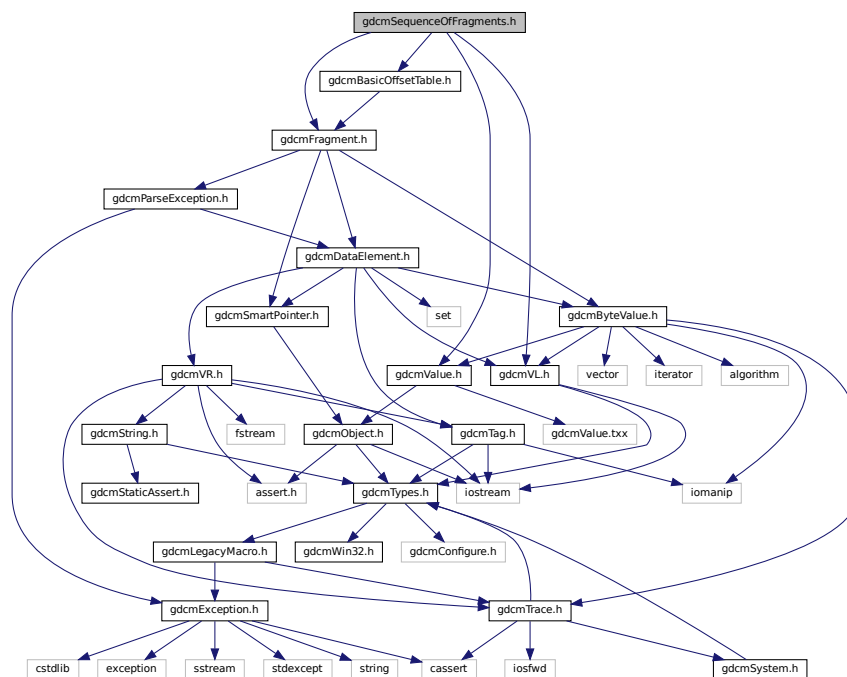

## Classes

- class [gdcm::SequenceOfFragments](#)  
Class to represent a Sequence Of Fragments.

## Namespaces

- [gdcm](#)

## 11.219 gdcmSequenceOfItems.h File Reference

```
#include "gdcmValue.h"
#include "gdcmItem.h"
#include <vector>
#include <cstring>
#include "gdcmSequenceOfItems.txx"
Include dependency graph for gdcmSequenceOfItems.h:
```

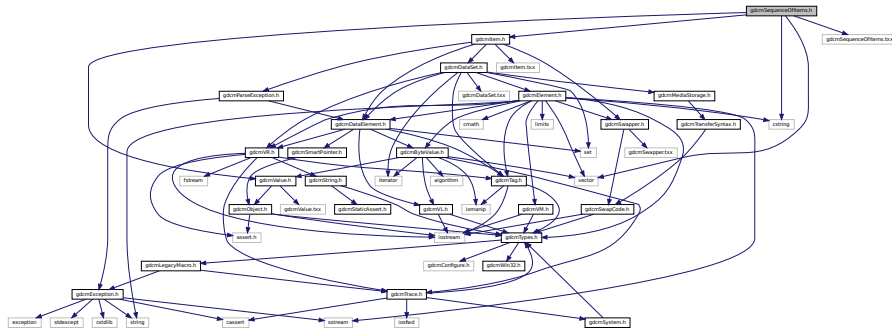

### Classes

- class [gdcm::SequenceOfItems](#)  
Class to represent a Sequence Of Items.

### Namespaces

- [gdcm](#)

## 11.220 gdcmSerieHelper.h File Reference

```
#include "gdcmTag.h"
#include "gdcmSmartPointer.h"
#include "gdcmFile.h"
#include <vector>
#include <string>
```



## 11.221 gdcSeries.h File Reference

```
#include "gdcTypes.h"
```

Include dependency graph for gdcSeries.h:

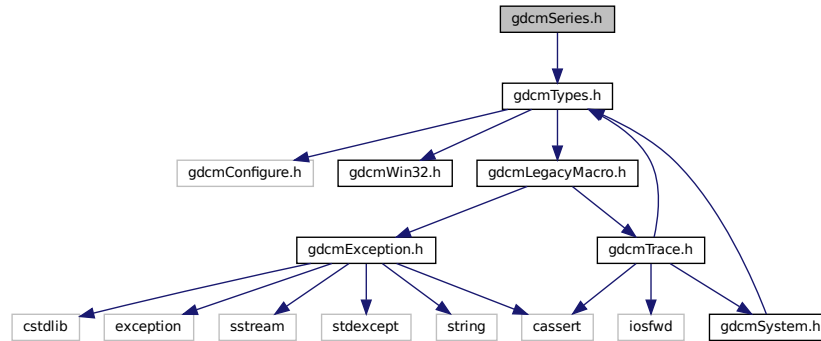

This graph shows which files directly or indirectly include this file:

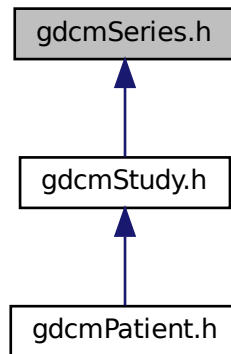

### Classes

- class [gdc::Series](#)  
*Series.*

### Namespaces

- [gdc](#)

## 11.222 gdcmServiceClassApplicationInformation.h File Reference

```
#include "gdcmTypes.h"
```

Include dependency graph for gdcmServiceClassApplicationInformation.h:

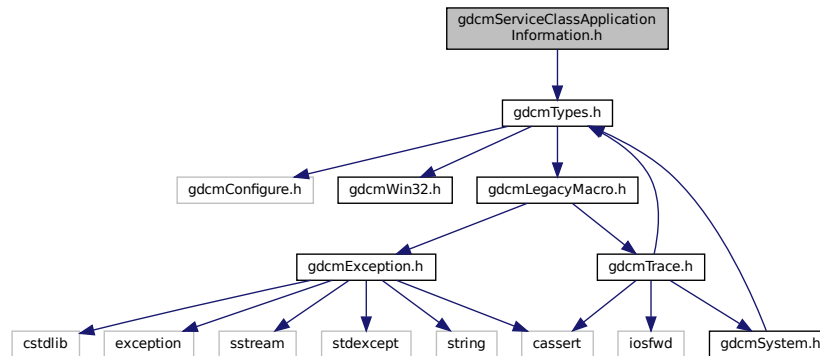

This graph shows which files directly or indirectly include this file:

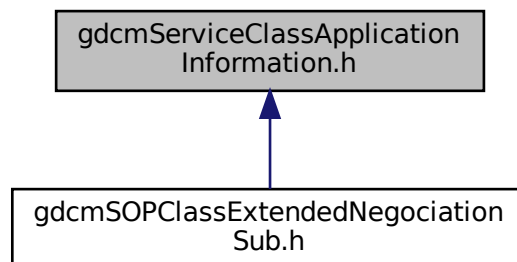

### Classes

- class [gdcm::network::ServiceClassApplicationInformation](#)

### Namespaces

- [gdcm](#)
- [gdcm::network](#)



Include dependency graph for gdcmSHA1.h:

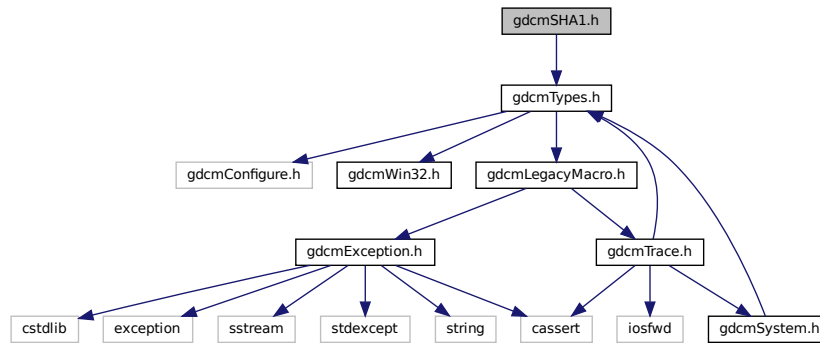

## Classes

- class [gdcm::SHA1](#)  
Class for *SHA1*.

## Namespaces

- [gdcm](#)

## 11.225 gdcmSimpleSubjectWatcher.h File Reference

```

#include "gdcmSubject.h"
#include "gdcmCommand.h"
#include "gdcmSmartPointer.h"
#include "gdcmAnonymizeEvent.h"
#include "gdcmDataEvent.h"

```





Include dependency graph for gdcmSmartPointer.h:

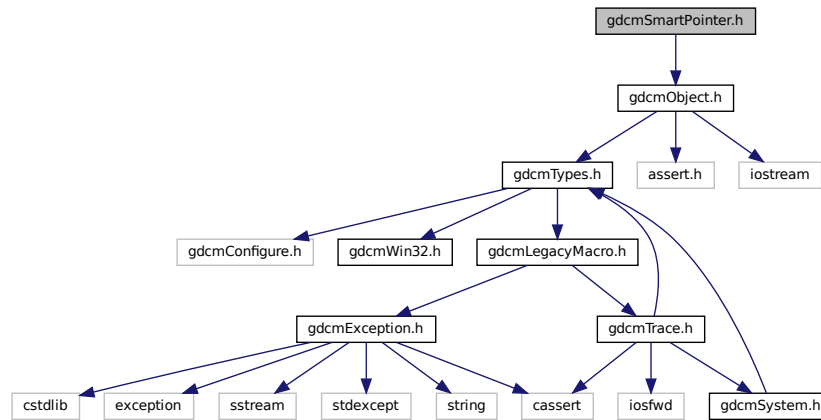

This graph shows which files directly or indirectly include this file:

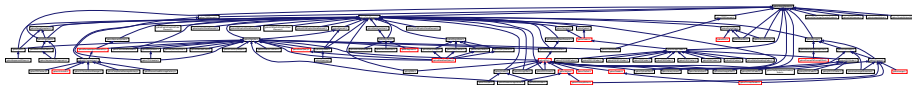

## Classes

- class [gdcm::SmartPointer< ObjectType >](#)  
*Class for Smart Pointer.*

## Namespaces

- [gdcm](#)

## 11.227 gdcmSOPClassExtendedNegociationSub.h File Reference

```
#include "gdcmServiceClassApplicationInformation.h"
```

Include dependency graph for `gdcmSOPClassExtendedNegociationSub.h`:

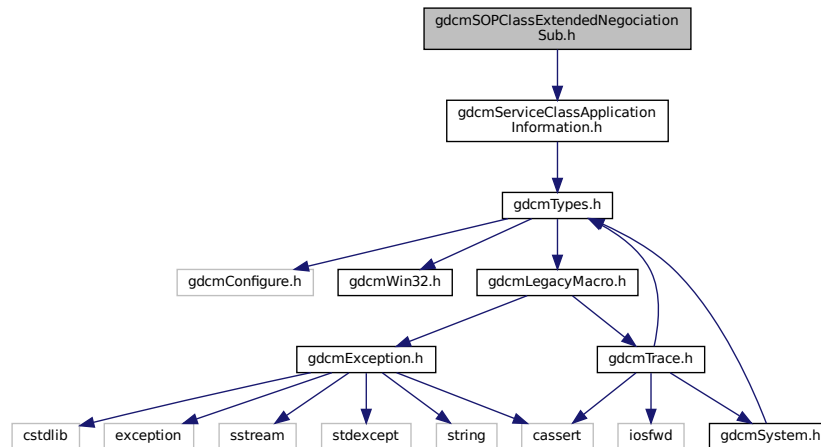

## Classes

- class `gdcm::network::SOPClassExtendedNegociationSub`  
*SOPClassExtendedNegociationSub.*

## Namespaces

- `gdcm`
- `gdcm::network`

## 11.228 gdcmSOPClassUIDToIOD.h File Reference

```
#include "gdcmUIDs.h"
```

Include dependency graph for gdcmSOPClassUIDToIOD.h:

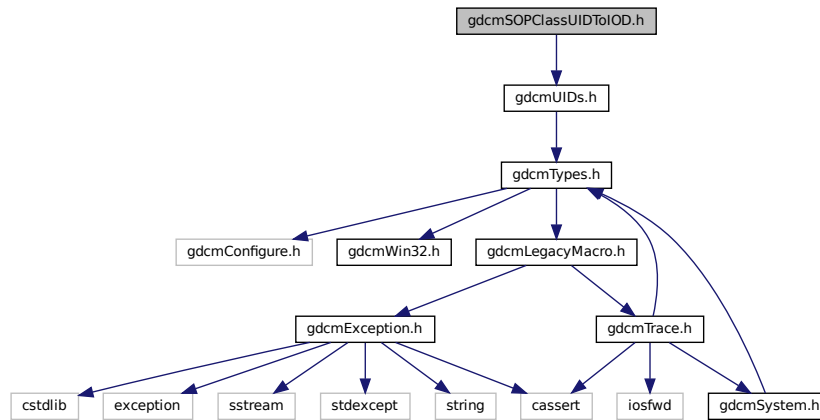

## Classes

- class [gdcm::SOPClassUIDToIOD](#)  
Class convert a class SOP Class UID into *IOD*.

## Namespaces

- [gdcm](#)

## 11.229 gdcmSorter.h File Reference

```

#include "gdcmDirectory.h"
#include "gdcmTag.h"
#include <vector>
#include <string>
#include <map>
#include <set>

```

Include dependency graph for `gdcmsorter.h`:

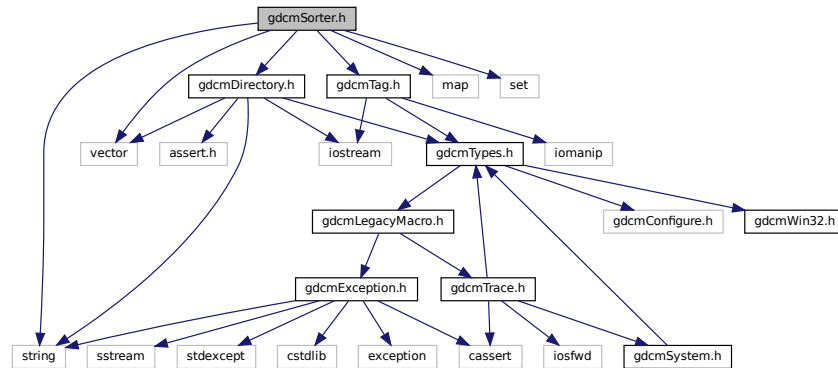

This graph shows which files directly or indirectly include this file:

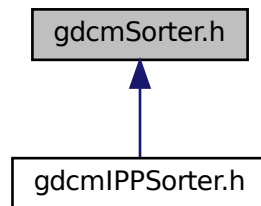

## Classes

- class `gdcmsorter::Sorter`  
*Sorter.*

## Namespaces

- `gdcmsorter`

## Functions

- `std::ostream & gdcmsorter::operator<< (std::ostream &os, const Sorter &s)`



Include dependency graph for `gdcmSpectroscopy.h`:

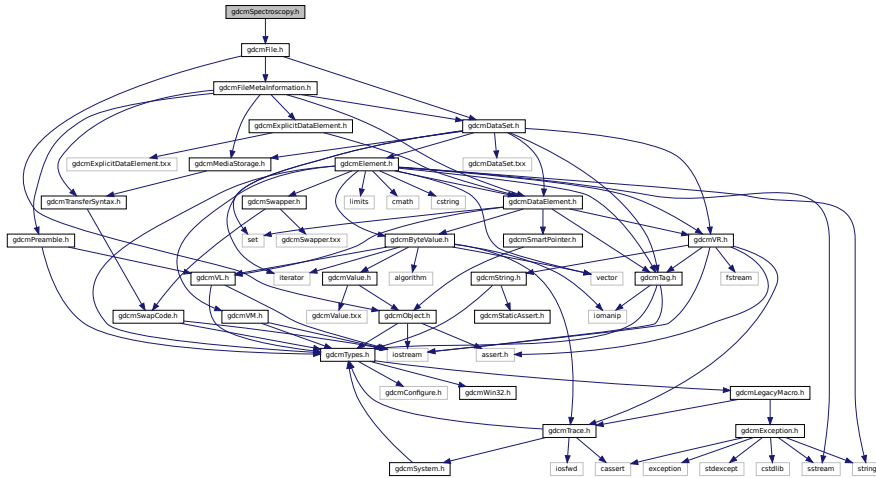

### Classes

- class `gdcm::Spectroscopy`  
*Spectroscopy class.*

### Namespaces

- `gdcm`

## 11.232 `gdcmSplitMosaicFilter.h` File Reference

```
#include "gdcmFile.h"
#include "gdcmImage.h"
```

Include dependency graph for `gdcmSplitMosaicFilter.h`:

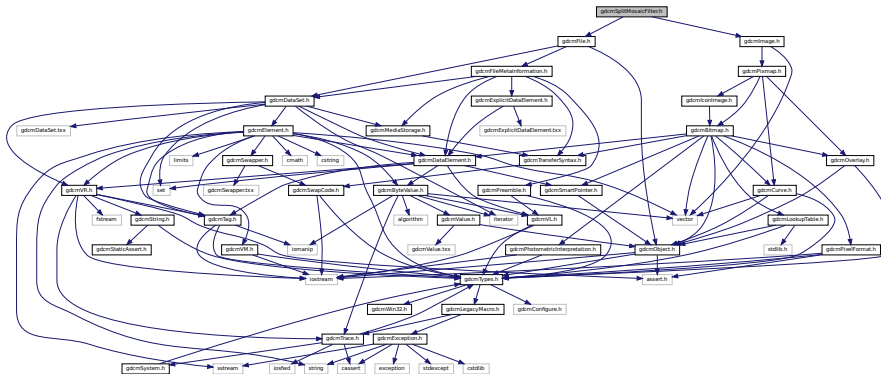

## Classes

- class [gdcM::SplitMosaicFilter](#)  
*SplitMosaicFilter* class.

## Namespaces

- [gdcM](#)

## 11.233 gdcMStaticAssert.h File Reference

This graph shows which files directly or indirectly include this file:

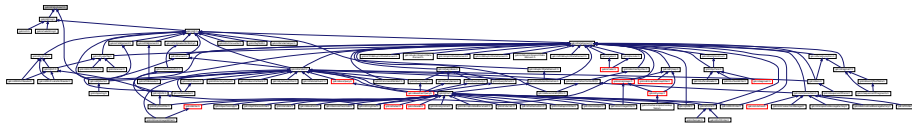

## Classes

- struct [gdcM::static\\_assert\\_test< x >](#)
- struct [gdcM::STATIC\\_ASSERTION\\_FAILURE< true >](#)

## Namespaces

- [gdcM](#)

## Macros

- #define [GDCM\\_DO\\_JOIN\(X, Y\) GDCM\\_DO\\_JOIN2\(X,Y\)](#)
- #define [GDCM\\_DO\\_JOIN2\(X, Y\) X##Y](#)
- #define [GDCM\\_JOIN\(X, Y\) GDCM\\_DO\\_JOIN\( X, Y \)](#)
- #define [GDCM\\_STATIC\\_ASSERT\(B\)](#)

*The GDCM\_JOIN + **LINE** is needed to create a uniq identifier.*

### 11.233.1 Macro Definition Documentation

### 11.233.1.1 GDCM\_DO\_JOIN

```
#define GDCM_DO_JOIN(  
    X,  
    Y ) GDCM_DO_JOIN2 (X, Y)
```

### 11.233.1.2 GDCM\_DO\_JOIN2

```
#define GDCM_DO_JOIN2(  
    X,  
    Y ) X##Y
```

### 11.233.1.3 GDCM\_JOIN

```
#define GDCM_JOIN(  
    X,  
    Y ) GDCM_DO_JOIN ( X, Y )
```

### 11.233.1.4 GDCM\_STATIC\_ASSERT

```
#define GDCM_STATIC_ASSERT(  
    B )
```

**Value:**

```
typedef ::gdcm::static_assert_test<\n    sizeof(::gdcm::STATIC_ASSERTION_FAILURE< (bool) ( B ) >>\  
    GDCM_JOIN(gdcm_static_assert_typedef_, __LINE__)
```

The GDCM\_JOIN + **LINE** is needed to create a uniq identifier.





```
#include "gdcmDataSet.h"
Include dependency graph for gdcmStreamImageWriter.h:
```

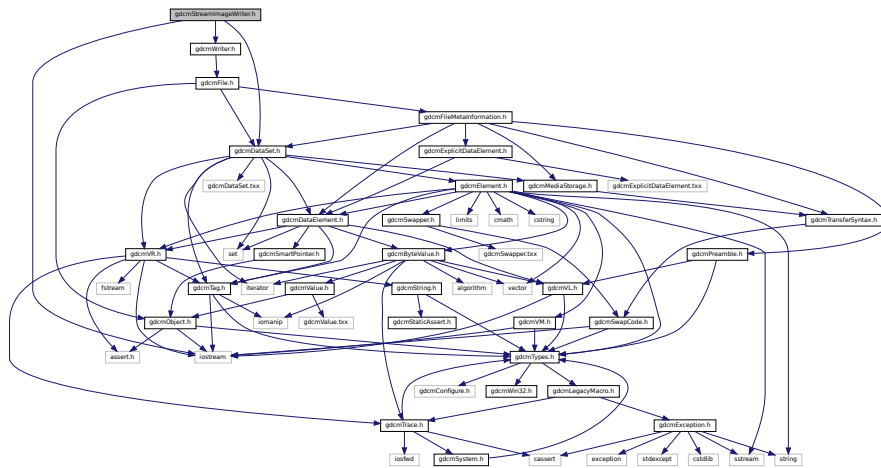

## Classes

- class [gdcm::StreamImageWriter](#)  
*StreamImageReader.*

## Namespaces

- [gdcm](#)

## 11.236 gdcmStrictScanner.h File Reference

```
#include "gdcmDirectory.h"
#include "gdcmSubject.h"
#include "gdcmTag.h"
#include "gdcmPrivateTag.h"
#include "gdcmSmartPointer.h"
#include <map>
#include <set>
#include <string>
```

```
#include <string.h>
```

Include dependency graph for gdcmStrictScanner.h:

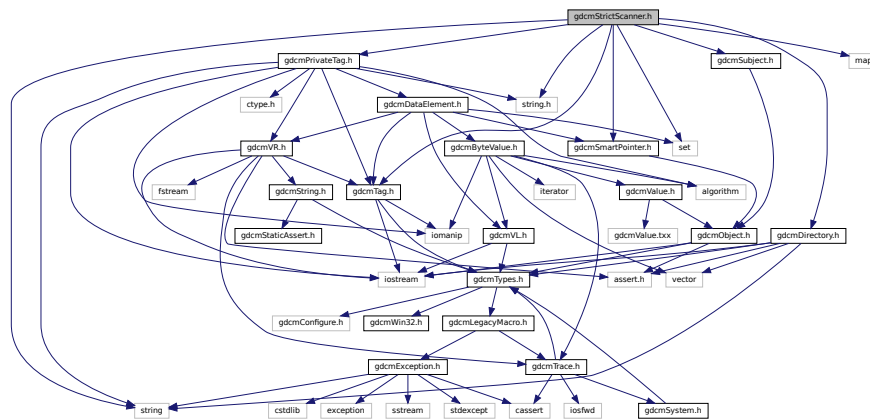

## Classes

- struct [gdcm::StrictScanner::ltstr](#)
- class [gdcm::StrictScanner](#)  
*StrictScanner.*

## Namespaces

- [gdcm](#)

## Functions

- `std::ostream & gdcm::operator<< (std::ostream &os, const StrictScanner &s)`

## 11.237 gdcmString.h File Reference

```
#include "gdcmTypes.h"
```

```
#include "gdcmStaticAssert.h"
```

Include dependency graph for `gdcmString.h`:

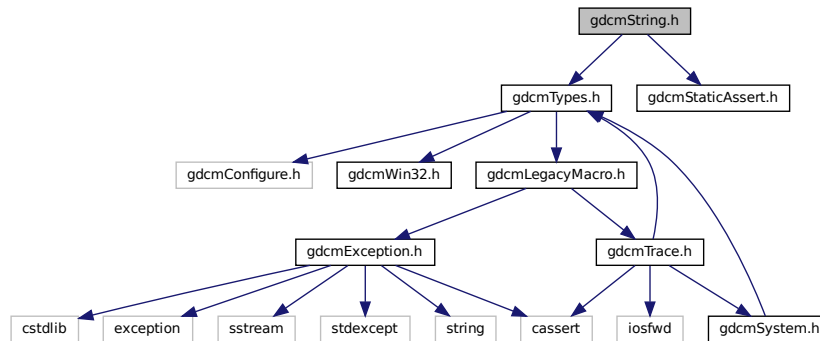

This graph shows which files directly or indirectly include this file:



## Classes

- class `gdcm::String< TDelimiter, TMaxLength, TPadChar >`  
*String.*

## Namespaces

- `gdcm`

## Functions

- `template<char TDelimiter, unsigned int TMaxLength, char TPadChar>`  
`std::istream & gdcm::operator>> (std::istream &is, String< TDelimiter, TMaxLength, TPadChar > &ms)`

## 11.238 gdcmStringFilter.h File Reference

```
#include "gdcmDataElement.h"
#include "gdcmDicts.h"
```

```
#include "gdcmFile.h"
```

Include dependency graph for gdcmStringFilter.h:

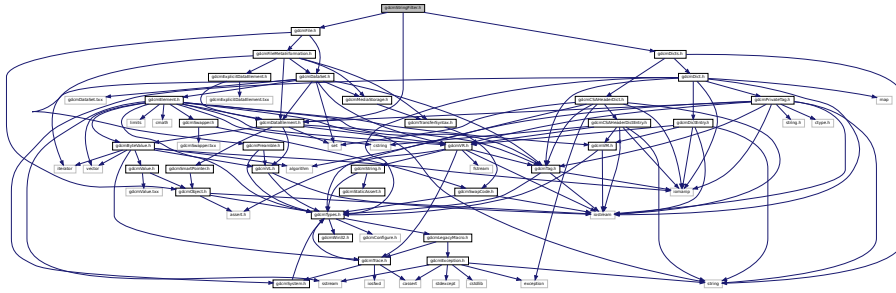

## Classes

- class `gdcm::StringFilter`  
*StringFilter.*

## Namespaces

- `gdcm`

## 11.239 gdcStudy.h File Reference

```
#include "gdcmTypes.h"
```

```
#include "gdcmSeries.h"
```

```
#include <vector>
```

Include dependency graph for gdcStudy.h:

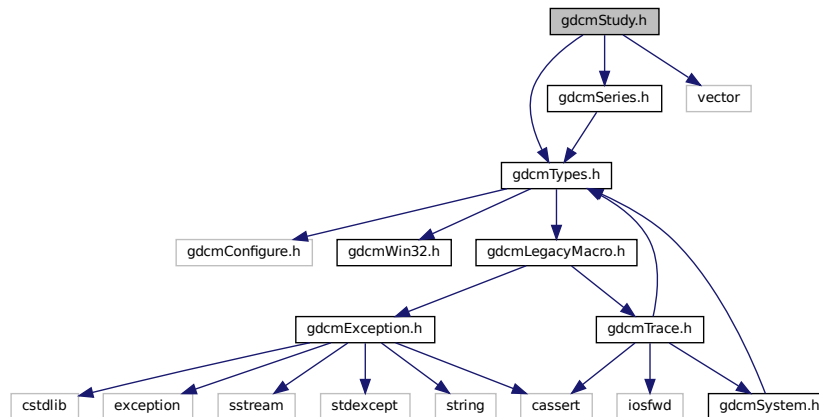

This graph shows which files directly or indirectly include this file:

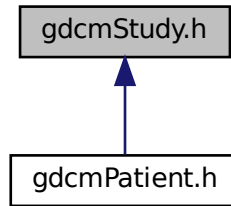

## Classes

- class [gdcm::Study](#)  
*Study.*

## Namespaces

- [gdcm](#)

## 11.240 gdcmSubject.h File Reference

```
#include "gdcmObject.h"
```

Include dependency graph for gdcmSubject.h:

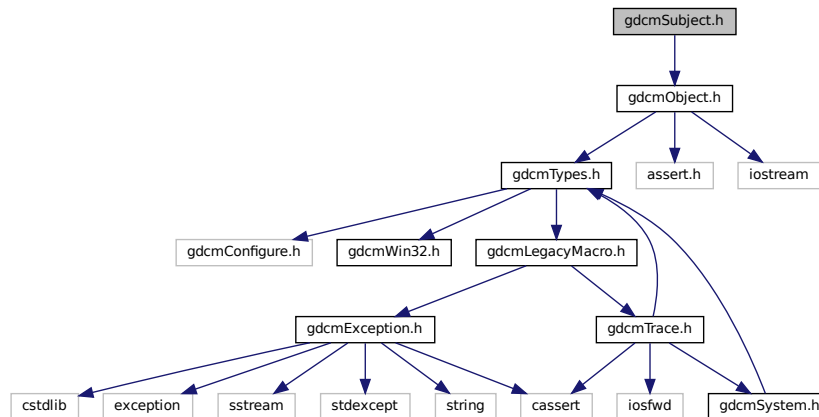



This graph shows which files directly or indirectly include this file:

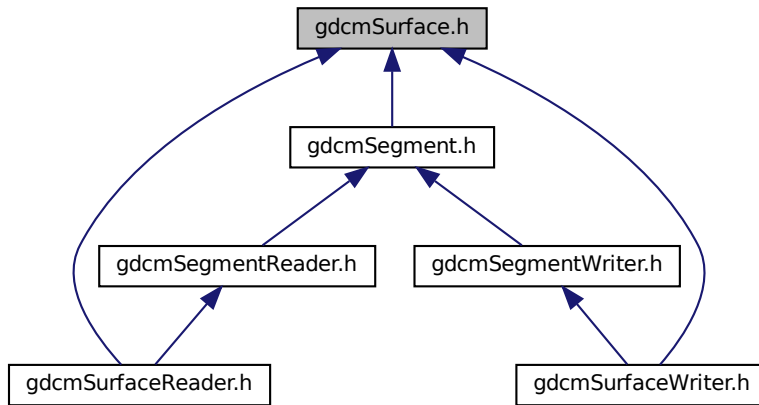

## Classes

- class [gdcm::Surface](#)  
*This class defines a SURFACE IE.*

## Namespaces

- [gdcm](#)

## 11.242 gdcmsurfacehelper.h File Reference

```
#include "gdcmTypes.h"
#include <vector>
#include <iostream>
```

Include dependency graph for gdcmsurfacehelper.h:

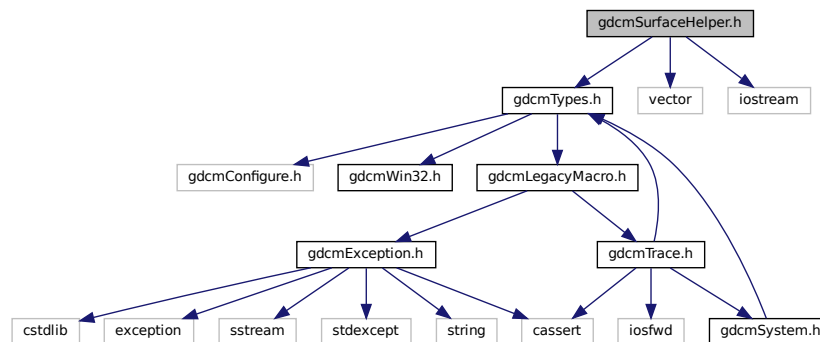



## Classes

- class [gdcmsurfaceReader::SurfaceHelper](#)  
*SurfaceHelper.*

## Namespaces

- [gdcmsurfaceReader](#)

## 11.243 gdcmsurfaceReader.h File Reference

```
#include <gdcmsurfaceSegmentReader.h>
```

```
#include <gdcmsurface.h>
```

Include dependency graph for gdcmsurfaceReader.h:

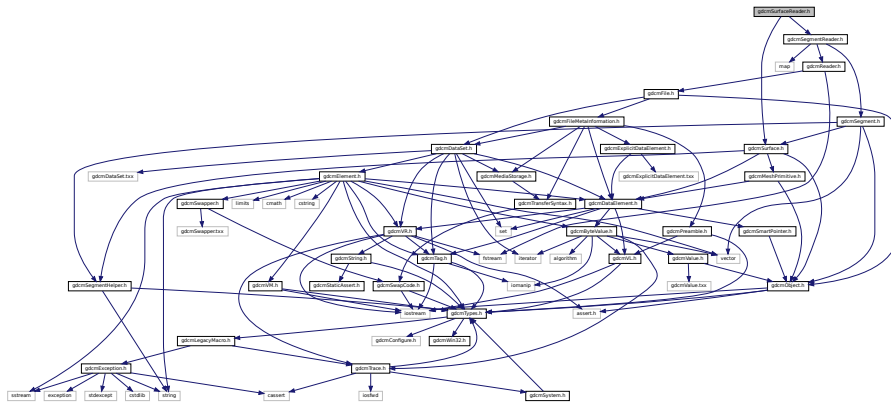

## Classes

- class [gdcmsurfaceReader::SurfaceReader](#)  
*This class defines a SURFACE IE reader.*

## Namespaces

- [gdcmsurfaceReader](#)



Include dependency graph for gdcmSwapCode.h:

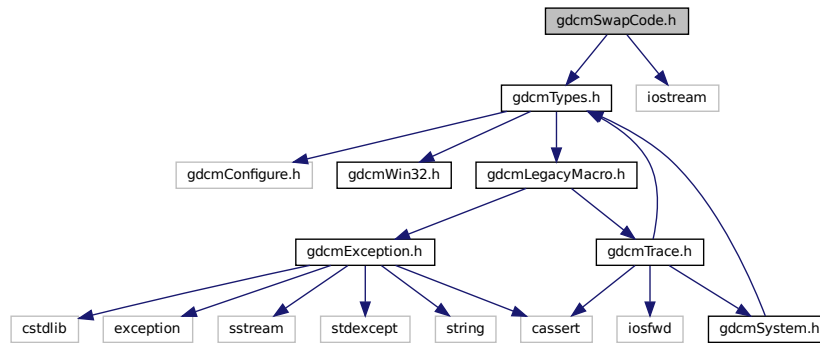

This graph shows which files directly or indirectly include this file:

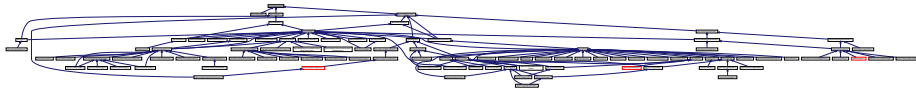

## Classes

- class [gdcm::SwapCode](#)  
*SwapCode* representation.

## Namespaces

- [gdcm](#)

## Functions

- `std::ostream & gdcm::operator<< (std::ostream &os, const SwapCode &sc)`

## 11.246 gdcmswapper.h File Reference

```
#include "gdcmswapCode.h"
#include "gdcmswapper.txx"
```

Include dependency graph for gdcmswapper.h:

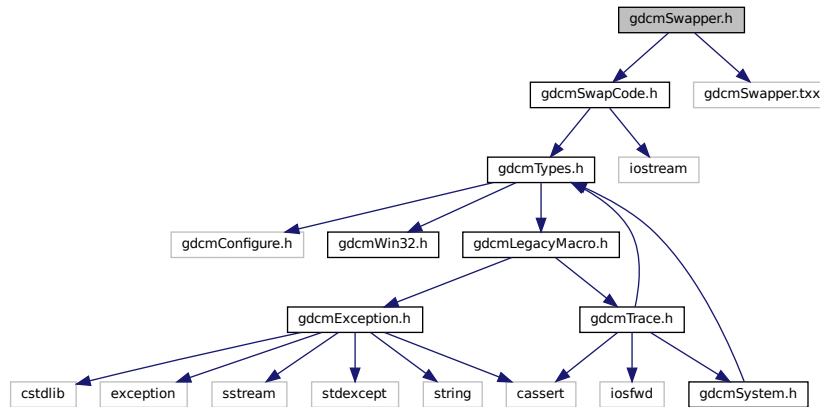

This graph shows which files directly or indirectly include this file:

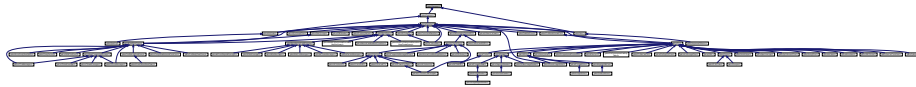

### Classes

- class [gdcmswapper::SwapperDoOp](#)
- class [gdcmswapper::SwapperNoOp](#)

### Namespaces

- [gdcmswapper](#)

## 11.247 gdcmSystem.h File Reference

```
#include "gdcmTypes.h"
```

Include dependency graph for gdcmSystem.h:

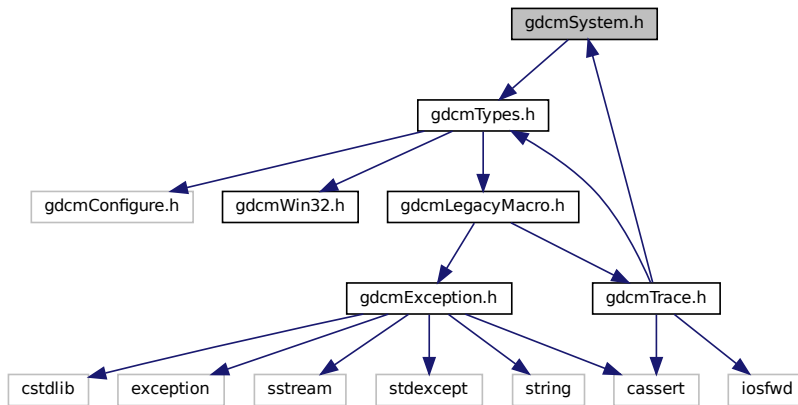

This graph shows which files directly or indirectly include this file:

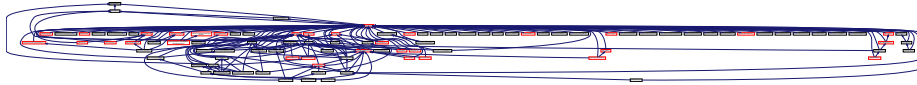

### Classes

- class [gdcm::System](#)  
*Class to do system operation.*

### Namespaces

- [gdcm](#)

## 11.248 gdcmTable.h File Reference

```
#include "gdcmTableEntry.h"
```

```
#include "gdcmTag.h"
```

```
#include <map>
```

Include dependency graph for `gdcTable.h`:

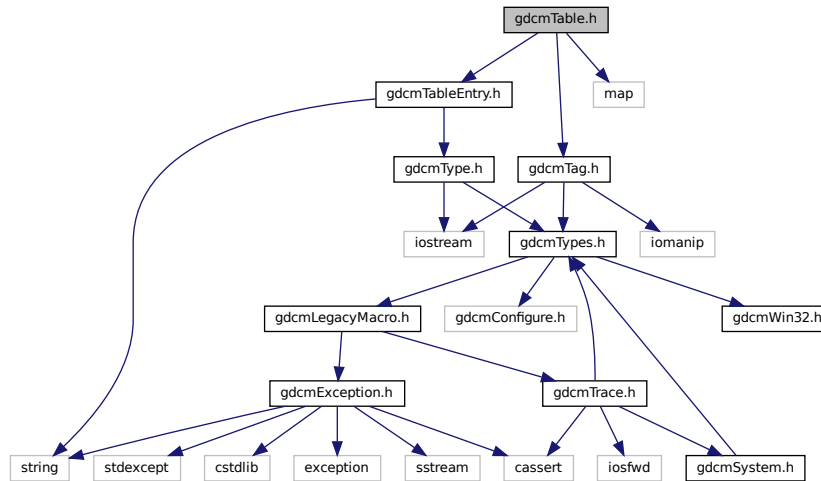

## Classes

- class [gdcm::Table](#)  
*Table.*

## Namespaces

- [gdcm](#)

## 11.249 gdcmTableEntry.h File Reference

```
#include "gdcmType.h"
#include <string>
```

Include dependency graph for gdcmTableEntry.h:

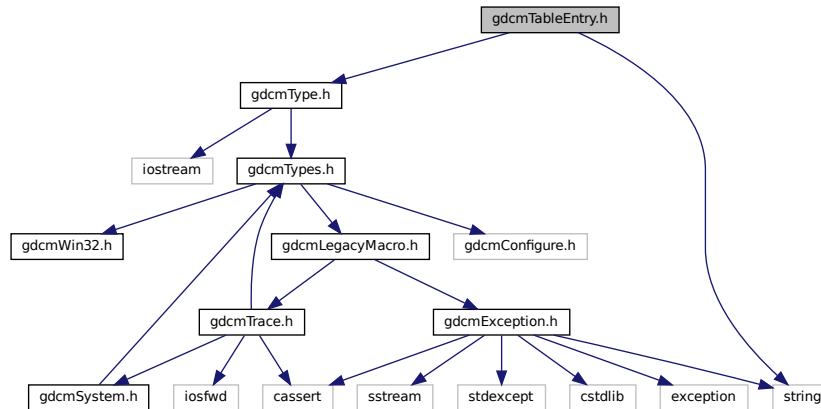

This graph shows which files directly or indirectly include this file:

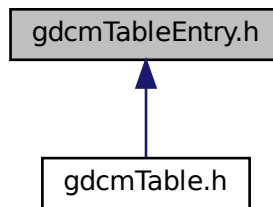

## Classes

- class [gdcm::TableEntry](#)  
*TableEntry*.

## Namespaces

- [gdcm](#)

## 11.250 gdcmTableReader.h File Reference

```
#include "gdcmTypes.h"
#include "gdcmDefs.h"
#include <string>
#include <vector>
#include <map>
```

Include dependency graph for gdcmTableReader.h:

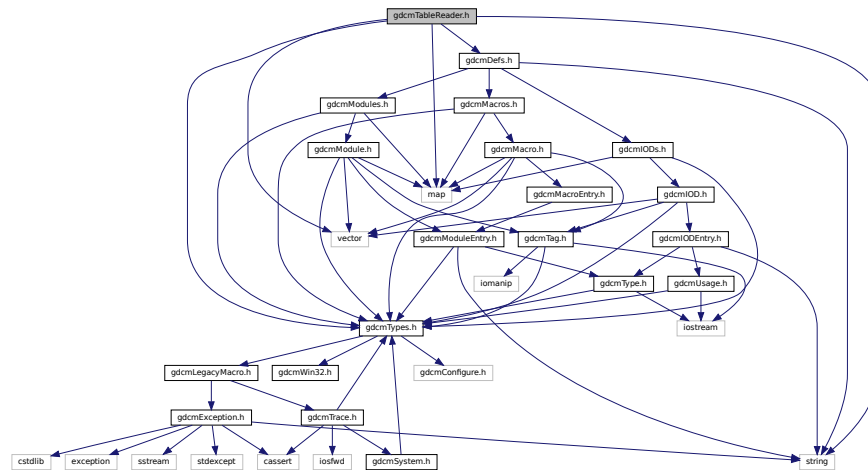

This graph shows which files directly or indirectly include this file:

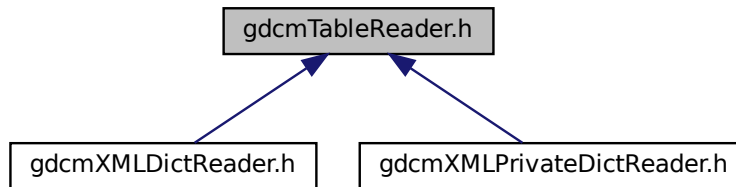

### Classes

- class [gdcm::TableReader](#)  
Class for representing a [TableReader](#).

### Namespaces

- [gdcm](#)



## 11.251 gdcmtag.h File Reference

```
#include "gdcmTypes.h"
```

```
#include <iostream>
```

```
#include <iomanip>
```

Include dependency graph for gdcmtag.h:

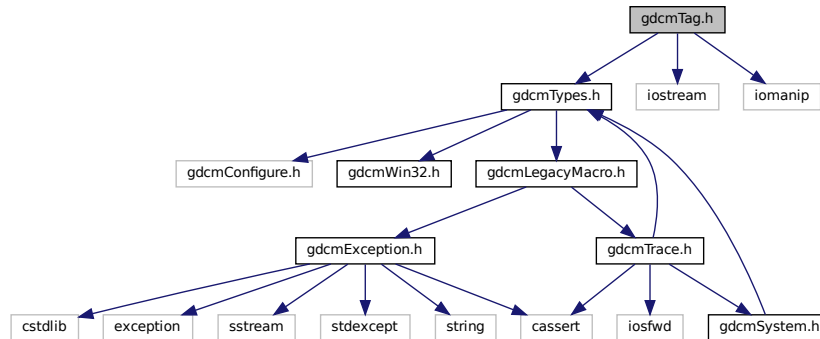

This graph shows which files directly or indirectly include this file:

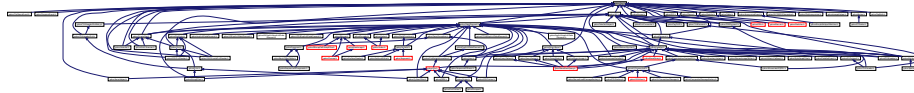

### Classes

- class [gdcm::Tag](#)

*Class to represent a DICOM Data [Element \(Attribute\) Tag \(Group, Element\)](#).*

### Namespaces

- [gdcm](#)

### Functions

- `std::ostream & gdcm::operator<< (std::ostream &_os, const Tag &_val)`
- `std::istream & gdcm::operator>> (std::istream &_is, Tag &_val)`

## 11.252 gdcmTagPath.h File Reference

```
#include "gdcmTag.h"
```

```
#include <vector>
```

Include dependency graph for gdcmTagPath.h:

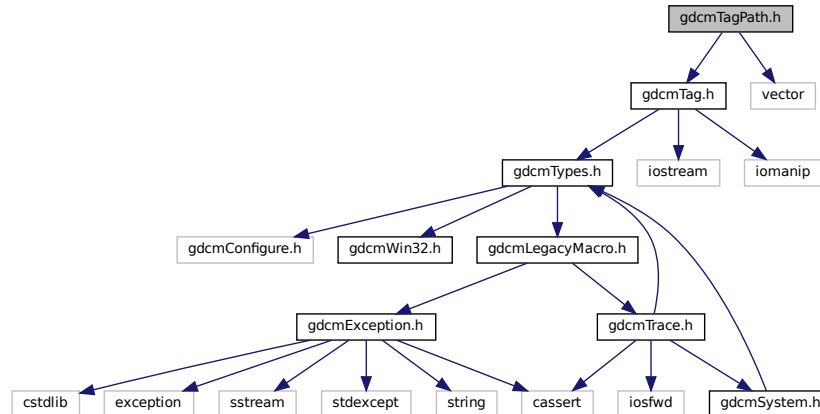

### Classes

- class [gdcm::TagPath](#)  
*class to handle a path of tag.*

### Namespaces

- [gdcm](#)

## 11.253 gdcmTagToVR.h File Reference

```
#include "gdcmVR.h"
```

Include dependency graph for gdcmTagToVR.h:

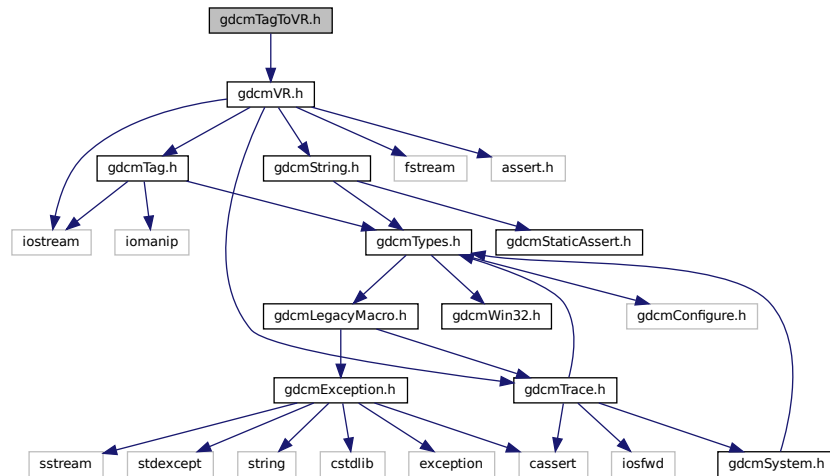

## Namespaces

- [gdcm](#)

## Functions

- VR::VRType [gdcm::GetVRFromTag](#) (Tag const &tag)

## 11.254 gdcmTerminal.h File Reference

```
#include "gdcmTypes.h"
```

Include dependency graph for gdcmTerminal.h:

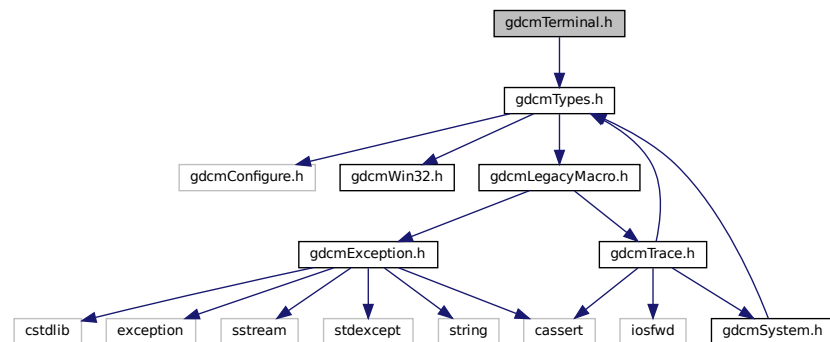

## Namespaces

- [gdc](#)
- [gdc::terminal](#)

*Class for Terminal.*

## Enumerations

- enum [gdc::terminal::Attribute](#) {  
  [gdc::terminal::reset](#) = 0 ,  
  [gdc::terminal::bright](#) = 1 ,  
  [gdc::terminal::dim](#) = 2 ,  
  [gdc::terminal::underline](#) = 3 ,  
  [gdc::terminal::blink](#) = 5 ,  
  [gdc::terminal::reverse](#) = 7 ,  
  [gdc::terminal::hidden](#) = 8 }
- enum [gdc::terminal::Color](#) {  
  [gdc::terminal::black](#) = 0 ,  
  [gdc::terminal::red](#) ,  
  [gdc::terminal::green](#) ,  
  [gdc::terminal::yellow](#) ,  
  [gdc::terminal::blue](#) ,  
  [gdc::terminal::magenta](#) ,  
  [gdc::terminal::cyan](#) ,  
  [gdc::terminal::white](#) }
- enum [gdc::terminal::Mode](#) {  
  [gdc::terminal::CONSOLE](#) = 0 ,  
  [gdc::terminal::VT100](#) }

## Functions

- [GDCM\\_EXPORT](#) std::string [gdc::terminal::setattribute](#) (Attribute att)
- [GDCM\\_EXPORT](#) std::string [gdc::terminal::setbgcolor](#) (Color c)
- [GDCM\\_EXPORT](#) std::string [gdc::terminal::setfgcolor](#) (Color c)
- [GDCM\\_EXPORT](#) void [gdc::terminal::setmode](#) (Mode m)

## 11.255 gdcTestDriver.h File Reference

```
#include <locale>  
#include <locale>
```

Include dependency graph for gdcmTestDriver.h:

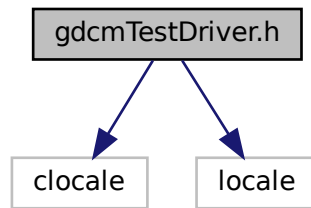

## 11.256 gdcmTesting.h File Reference

```
#include "gdcmTypes.h"
```

```
#include <iostream>
```

Include dependency graph for gdcmTesting.h:

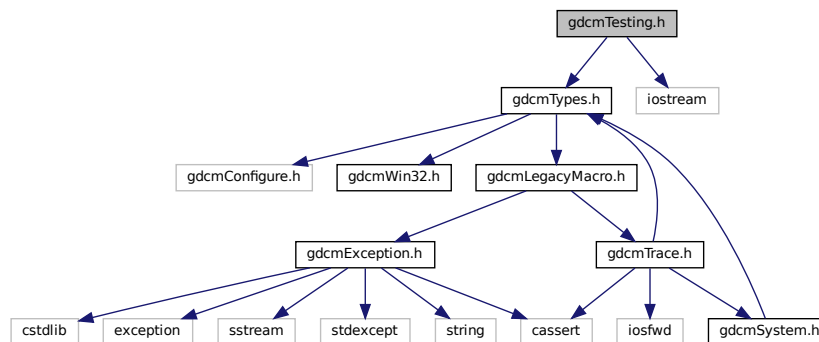

### Classes

- class [gdcm::Testing](#)  
*class for testing*

### Namespaces

- [gdcm](#)

## 11.257 gdcmTrace.h File Reference

```
#include "gdcmTypes.h"
#include "gdcmSystem.h"
#include <iosfwd>
#include <cassert>
```

Include dependency graph for gdcmTrace.h:

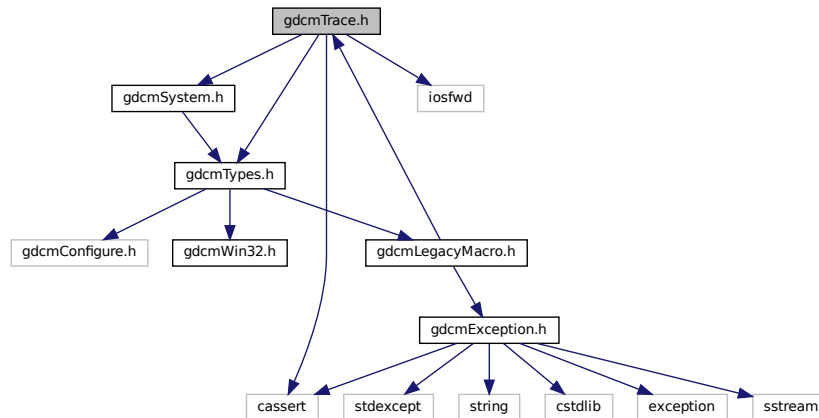

This graph shows which files directly or indirectly include this file:



### Classes

- class [gdcm::Trace](#)  
*Trace.*

### Namespaces

- [gdcm](#)

### Macros

- #define [GDCM\\_FUNCTION](#) "<unknown>"
- #define [gdcmAssertAlwaysMacro](#)(arg) [gdcmAssertMacro](#)(arg)  
*AssertAlways.*
- #define [gdcmAssertMacro](#)(arg)

- Assert.*

  - #define `gdcmDebugMacro`(msg)
- Debug.*

  - #define `gdcmErrorMacro`(msg)

*Error this is pretty bad, more than just warning It could mean lost of data, something not handle...*
- #define `gdcmWarningMacro`(msg)

*Warning.*

## 11.257.1 Macro Definition Documentation

### 11.257.1.1 GDCM\_FUNCTION

```
#define GDCM_FUNCTION "<unknown>"
```

### 11.257.1.2 gdcmAssertAlwaysMacro

```
#define gdcmAssertAlwaysMacro(  
    arg ) gdcmAssertMacro(arg)
```

AssertAlways.

Parameters

<i>arg</i>	argument to test An easy solution to pass also a message is to do: <code>gdcmAssertMacro( "my message" &amp;&amp; 2 &lt; 3 )</code>
------------	---

### 11.257.1.3 gdcmAssertMacro

```
#define gdcmAssertMacro(  
    arg )
```

**Value:**

```
{  
    if( !(arg) )  
    {  
        std::ostringstream osmacro;  
        osmacro << "Assert: In " << __FILE__ " ", line " << __LINE__  
            << ", function " << GDCM_FUNCTION  
            << "\n\n";  
        std::ostream &_os = gdcm::Trace::GetErrorStream();  
        _os << osmacro.str() << std::endl;  
        assert ( arg );  
    }  
}
```

```

    }
}
GDCM_NOOP_STATEMENT

```

Assert.

#### Parameters

<i>arg</i>	argument to test An easy solution to pass also a message is to do: <code>gdcmAssertMacro( "my message" &amp;&amp; 2 &lt; 3 )</code>
------------	---

### 11.257.1.4 gdcmDebugMacro

```

#define gdcmDebugMacro(
    msg )

```

#### Value:

```

{
    if( gdcm::Trace::GetDebugFlag() )
    {
        std::ostringstream osmacro;
        osmacro << "Debug: In " __FILE__ ", line " << __LINE__
            << ", function " << GDCM_FUNCTION << '\n'
            << "Last system error was: "
            << gdcm::System::GetLastSystemError() << '\n' << msg;
        std::ostream &_os = gdcm::Trace::GetDebugStream();
        _os << osmacro.str() << "\n\n" << std::endl;
    }
}
GDCM_NOOP_STATEMENT

```

Debug.

#### Parameters

<i>msg</i>	message part
------------	--------------

### 11.257.1.5 gdcmErrorMacro

```

#define gdcmErrorMacro(
    msg )

```

#### Value:

```

{
    if( gdcm::Trace::GetErrorFlag() )
    {
        std::ostringstream osmacro;
        osmacro << "Error: In " __FILE__ ", line " << __LINE__
            << ", function " << GDCM_FUNCTION << '\n'
            << msg << "\n\n";
        std::ostream &_os = gdcm::Trace::GetErrorStream();
        _os << osmacro.str() << std::endl;
    }
}

```



```
}  
GDCM_NOOP_STATEMENT
```

Error this is pretty bad, more than just warning It could mean lost of data, something not handle...

## Parameters

<i>msg</i>	second message part
------------	---------------------

11.257.1.6 `gdcWarningMacro`

```
#define gdcWarningMacro(
    msg )
```

## Value:

```
{
    if( gdc::Trace::GetWarningFlag() )
    {
        std::ostringstream osmacro;
        osmacro << "Warning: In " << __FILE__ " , line " << __LINE__
            << " , function " << GDCM_FUNCTION << "\n"
            << msg << "\n\n";
        std::ostream &_os = gdc::Trace::GetWarningStream();
        _os << osmacro.str() << std::endl;
    }
}
GDCM_NOOP_STATEMENT
```

Warning.

## Parameters

<i>msg</i>	message part
------------	--------------

11.258 `gdcTransferSyntax.h` File Reference

```
#include "gdcSwapCode.h"
```

Include dependency graph for gdcmTransferSyntax.h:

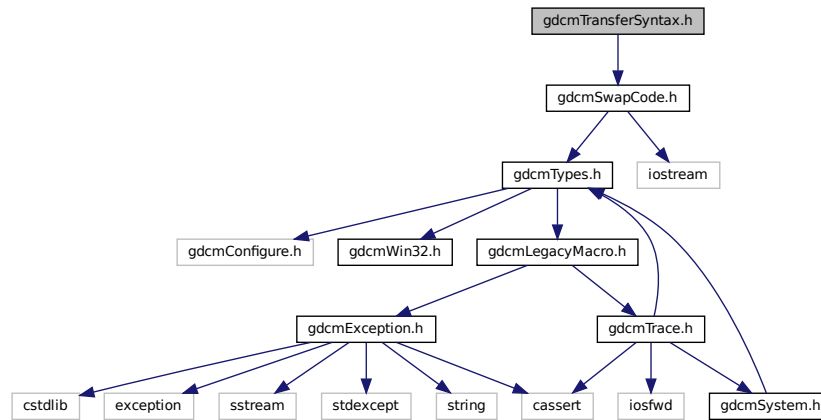

This graph shows which files directly or indirectly include this file:

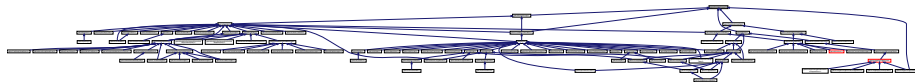

## Classes

- class [gdcm::TransferSyntax](#)  
*Class to manipulate Transfer Syntax.*

## Namespaces

- [gdcm](#)

## Functions

- `std::ostream & gdcm::operator<< (std::ostream &_os, const TransferSyntax &ts)`

## 11.259 gdcmTransferSyntaxSub.h File Reference

```
#include "gdcmTypes.h"
#include "gdcmTransferSyntax.h"
#include "gdcmUIDs.h"
Include dependency graph for gdcmTransferSyntaxSub.h:
```

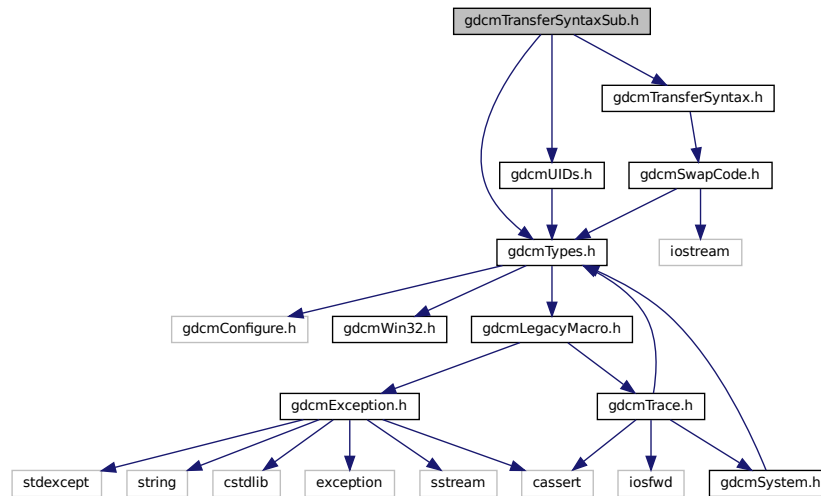

This graph shows which files directly or indirectly include this file:

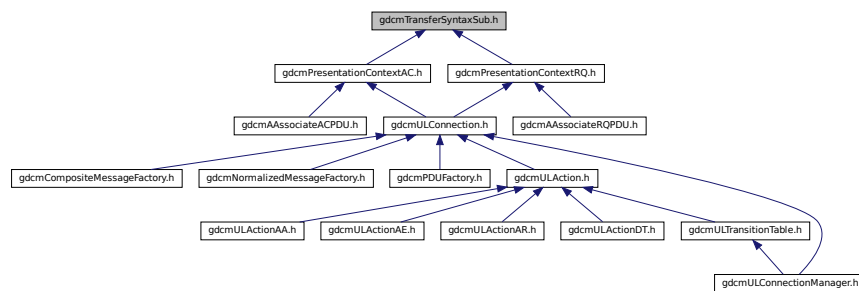

### Classes

- class [gdcm::network::TransferSyntaxSub](#)  
*TransferSyntaxSub.*

### Namespaces

- [gdcm](#)
- [gdcm::network](#)

## 11.260 gdcType.h File Reference

```
#include "gdcTypes.h"
```

```
#include <iostream>
```

Include dependency graph for gdcType.h:

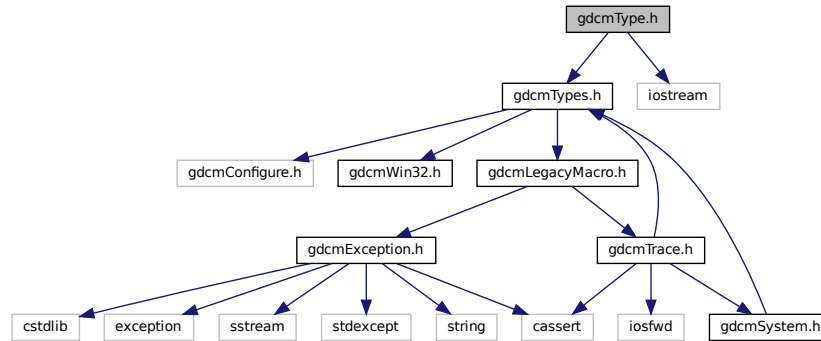

This graph shows which files directly or indirectly include this file:

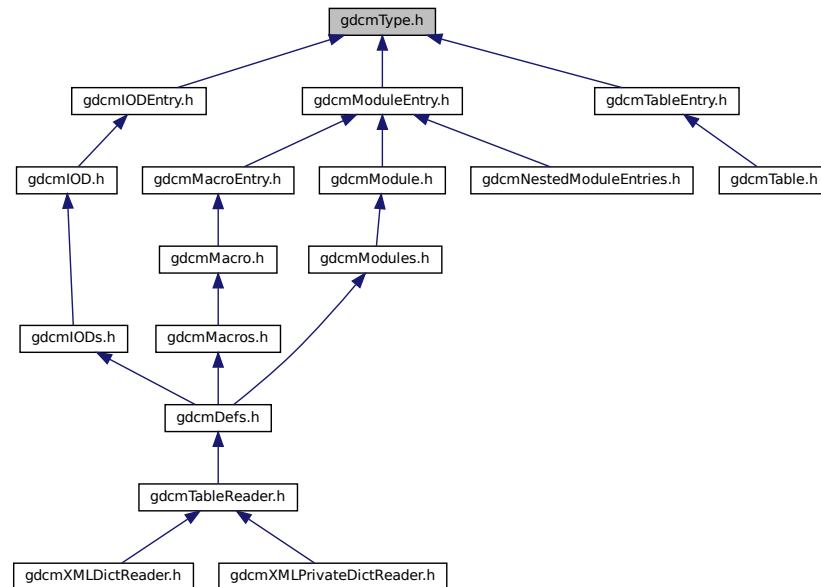

### Classes

- class [gdc::Type](#)  
*Type*.

## Namespaces

- [gdc](#)

## Functions

- `std::ostream & gdc::operator<< (std::ostream &_os, const Type &val)`

## 11.261 gdcTypes.h File Reference

```
#include "gdcmConfigure.h"
#include "gdcmWin32.h"
#include "gdcmLegacyMacro.h"
Include dependency graph for gdcTypes.h:
```

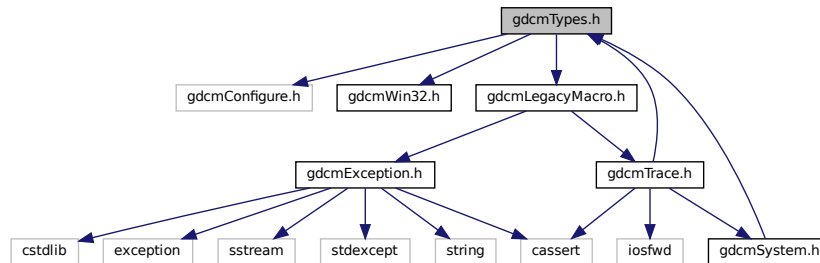

## 11.262 gdcUIDGenerator.h File Reference

```
#include "gdcTypes.h"
Include dependency graph for gdcUIDGenerator.h:
```

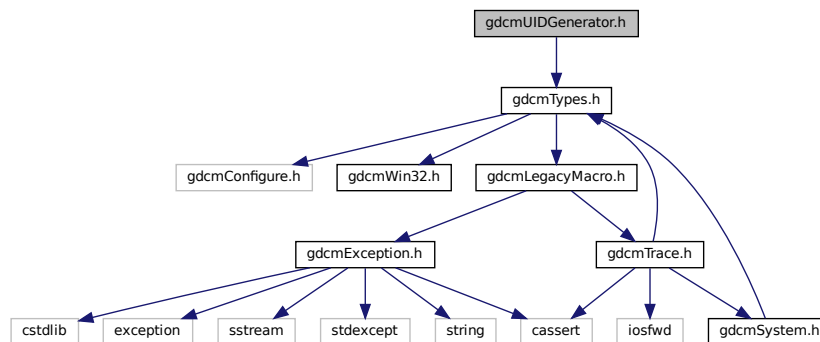

## Classes

- class [gdc::UIDGenerator](#)  
*Class for generating unique UID.*

## Namespaces

- [gdc](#)

## 11.263 gdcUIDs.h File Reference

```
#include "gdcTypes.h"
```

Include dependency graph for gdcUIDs.h:

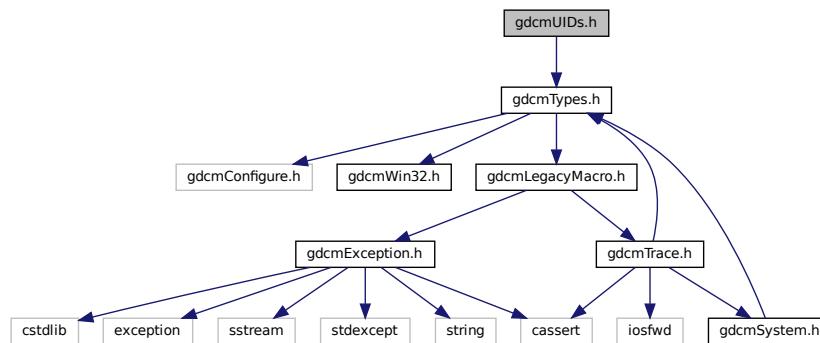

This graph shows which files directly or indirectly include this file:

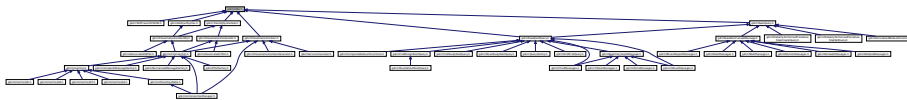

## Classes

- class [gdc::UIDs](#)  
*all known uids*

## Namespaces

- [gdc](#)

## Functions

- `std::ostream & gdcmm::operator<<` (`std::ostream &_os, const UIDs &uid`)

## 11.264 gdcmmULAction.h File Reference

```
#include "gdcmmNetworkStateID.h"
#include "gdcmmULEvent.h"
#include "gdcmmULConnection.h"
Include dependency graph for gdcmmULAction.h:
```

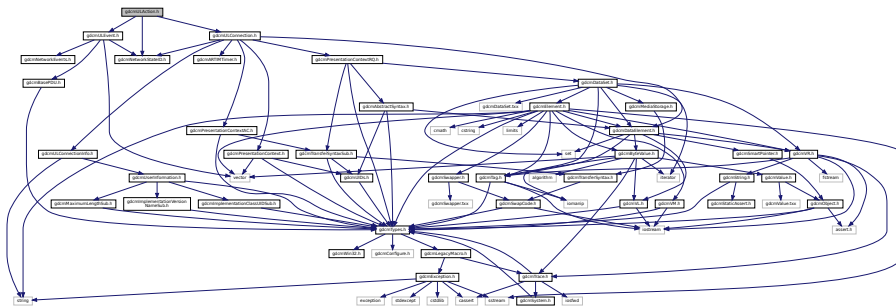

This graph shows which files directly or indirectly include this file:

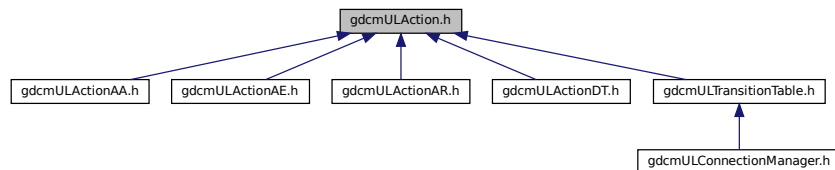

## Classes

- class `gdcmm::network::ULAction`  
*ULAction.*

## Namespaces

- `gdcmm`
- `gdcmm::network`



## 11.265 gdcmULActionAA.h File Reference

```
#include "gdcmULAction.h"
```

Include dependency graph for gdcmULActionAA.h:

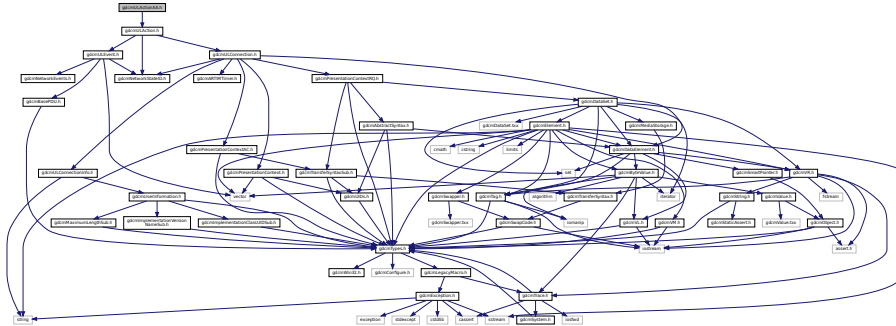

### Classes

- class [gdcm::network::ULActionAA1](#)
- class [gdcm::network::ULActionAA2](#)
- class [gdcm::network::ULActionAA3](#)
- class [gdcm::network::ULActionAA4](#)
- class [gdcm::network::ULActionAA5](#)
- class [gdcm::network::ULActionAA6](#)
- class [gdcm::network::ULActionAA7](#)
- class [gdcm::network::ULActionAA8](#)

### Namespaces

- [gdcm](#)
- [gdcm::network](#)

## 11.266 gdcmULActionAE.h File Reference

```
#include "gdcmULAction.h"
```

Include dependency graph for gdcmULActionAE.h:

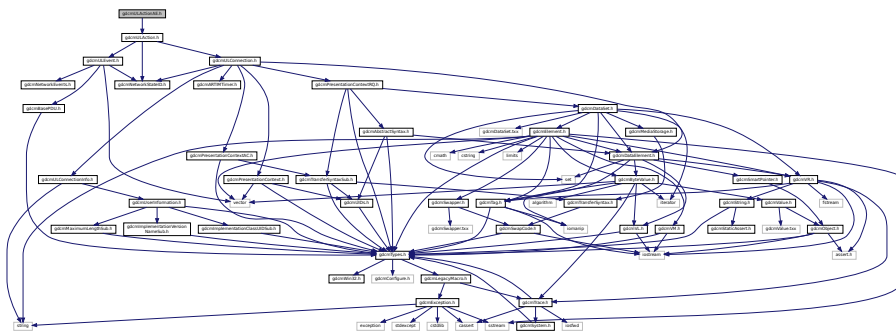

## Classes

- class [gdcmm::network::ULActionAE1](#)
- class [gdcmm::network::ULActionAE2](#)
- class [gdcmm::network::ULActionAE3](#)
- class [gdcmm::network::ULActionAE4](#)
- class [gdcmm::network::ULActionAE5](#)
- class [gdcmm::network::ULActionAE6](#)
- class [gdcmm::network::ULActionAE7](#)
- class [gdcmm::network::ULActionAE8](#)

## Namespaces

- [gdcmm](#)
- [gdcmm::network](#)

## 11.267 gdcmmULActionAR.h File Reference

```
#include "gdcmmULAction.h"
```

Include dependency graph for gdcmmULActionAR.h:

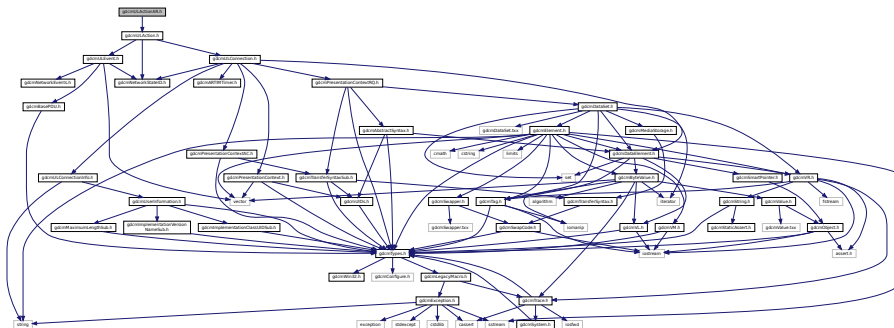

## Classes

- class [gdcmm::network::ULActionAR1](#)
- class [gdcmm::network::ULActionAR10](#)
- class [gdcmm::network::ULActionAR2](#)
- class [gdcmm::network::ULActionAR3](#)
- class [gdcmm::network::ULActionAR4](#)
- class [gdcmm::network::ULActionAR5](#)
- class [gdcmm::network::ULActionAR6](#)
- class [gdcmm::network::ULActionAR7](#)
- class [gdcmm::network::ULActionAR8](#)
- class [gdcmm::network::ULActionAR9](#)

## Namespaces

- [gdcm](#)
- [gdcm::network](#)

## 11.268 gdcmULActionDT.h File Reference

```
#include "gdcmULAction.h"
```

Include dependency graph for gdcmULActionDT.h:

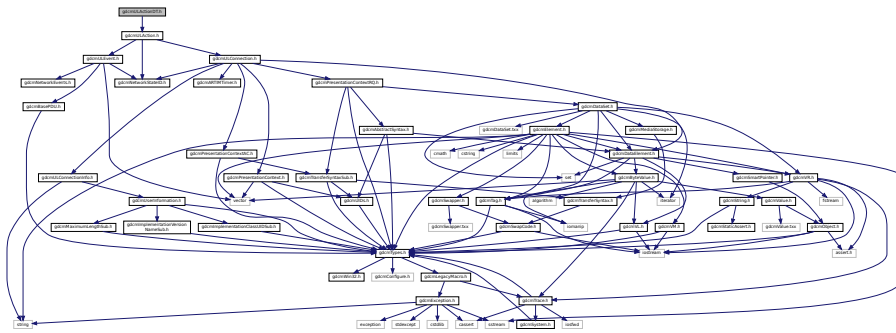

## Classes

- class [gdcm::network::ULActionDT1](#)
- class [gdcm::network::ULActionDT2](#)

## Namespaces

- [gdcm](#)
- [gdcm::network](#)

## 11.269 gdcmULBasicCallback.h File Reference

```
#include "gdcmULConnectionCallback.h"
```

```
#include "gdcmDataSet.h"
```

```
#include <vector>
```

Include dependency graph for `gdcmULBasicCallback.h`:

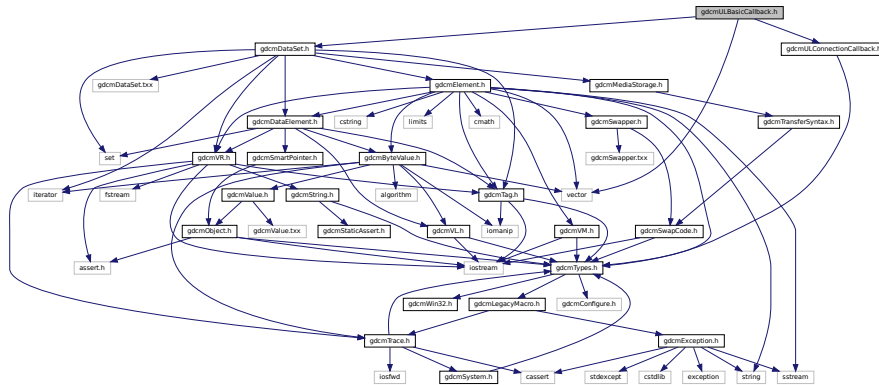

## Classes

- class `gdcm::network::ULBasicCallback`  
*ULBasicCallback.*

## Namespaces

- `gdcm`
- `gdcm::network`

## 11.270 gdcmULConnection.h File Reference

```
#include "gdcmNetworkStateID.h"
#include "gdcmARTIMTimer.h"
#include "gdcmULConnectionInfo.h"
#include "gdcmPresentationContextRQ.h"
#include "gdcmDataElement.h"
#include "gdcmPresentationContextAC.h"
#include "gdcmPresentationContext.h"
```

Include dependency graph for `gdcmULConnection.h`:

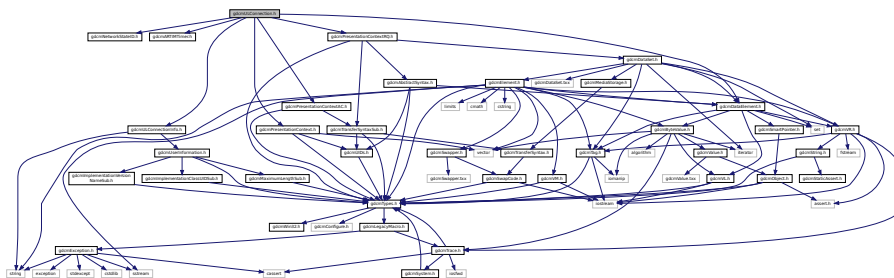

This graph shows which files directly or indirectly include this file:

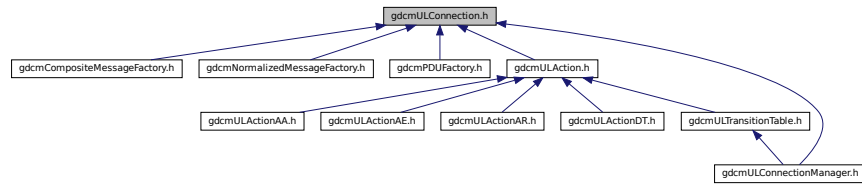

## Classes

- class [gdcm::network::ULConnection](#)  
*ULConnection.*

## Namespaces

- [gdcm](#)
- [gdcm::network](#)

## 11.271 gdcmULConnectionCallback.h File Reference

```
#include "gdcmTypes.h"
```

Include dependency graph for gdcmULConnectionCallback.h:

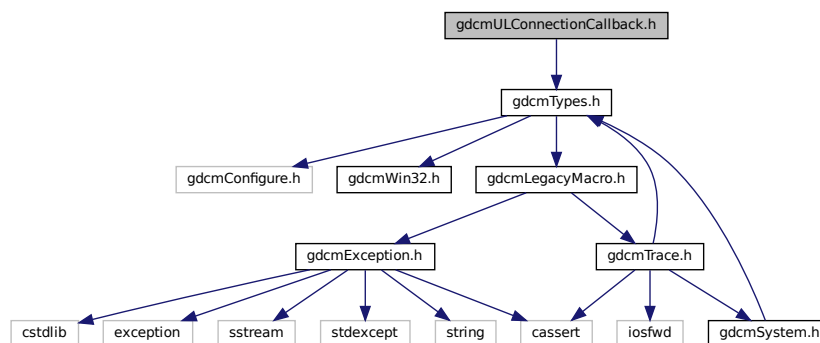

This graph shows which files directly or indirectly include this file:

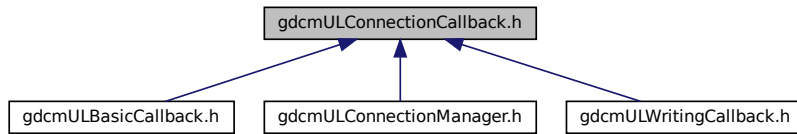

## Classes

- class [gdcm::network::ULConnectionCallback](#)

## Namespaces

- [gdcm](#)
- [gdcm::network](#)

## 11.272 gdcmULConnectionInfo.h File Reference

```
#include "gdcmUserInformation.h"
```

```
#include <string>
```

Include dependency graph for `gdcmULConnectionInfo.h`:

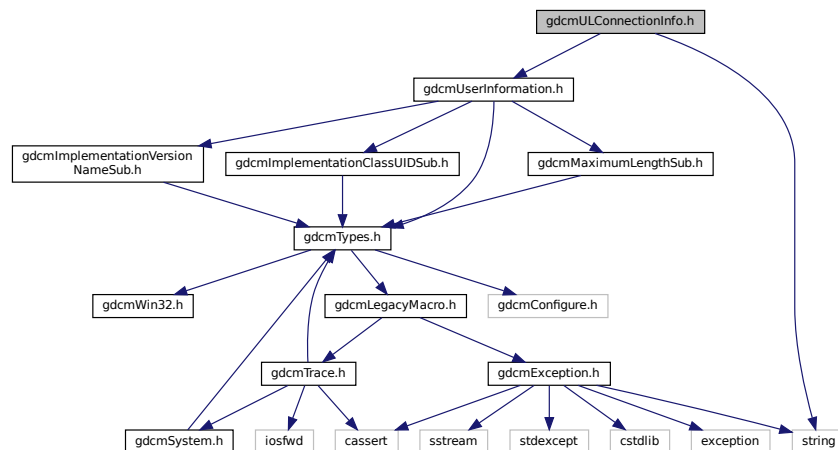

This graph shows which files directly or indirectly include this file:

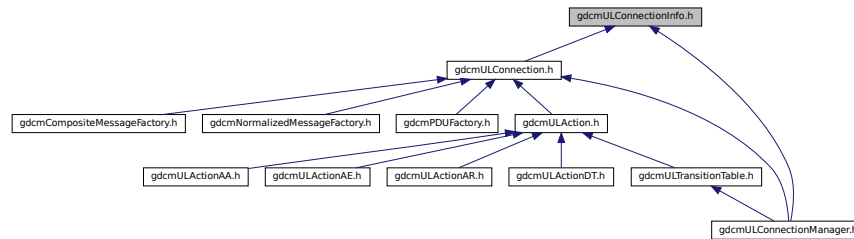

## Classes

- class `gdcm::network::ULConnectionInfo`  
*ULConnectionInfo.*

## Namespaces

- `gdcm`
- `gdcm::network`

## 11.273 gdcmULConnectionManager.h File Reference

```

#include "gdcmULTransitionTable.h"
#include "gdcmULConnection.h"
#include "gdcmULConnectionInfo.h"
#include "gdcmPresentationDataValue.h"
#include "gdcmULConnectionCallback.h"
#include "gdcmSubject.h"
#include "gdcmPresentationContext.h"

```

Include dependency graph for `gdcmULConnectionManager.h`:

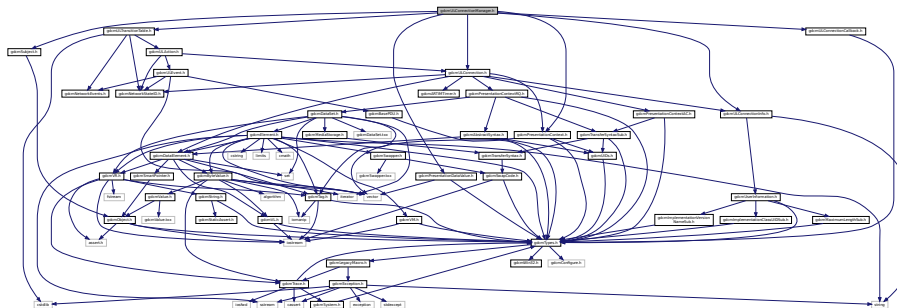

## Classes

- class [gdcmm::network::ULConnectionManager](#)  
*ULConnectionManager.*

## Namespaces

- [gdcmm](#)
- [gdcmm::network](#)

## 11.274 gdcmmULEvent.h File Reference

```
#include "gdcmmNetworkStateID.h"
#include "gdcmmNetworkEvents.h"
#include "gdcmmBasePDU.h"
#include <vector>
```

Include dependency graph for gdcmmULEvent.h:

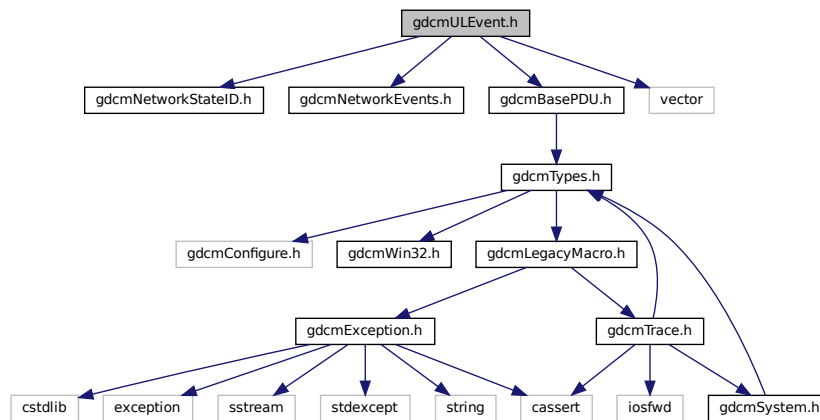

This graph shows which files directly or indirectly include this file:

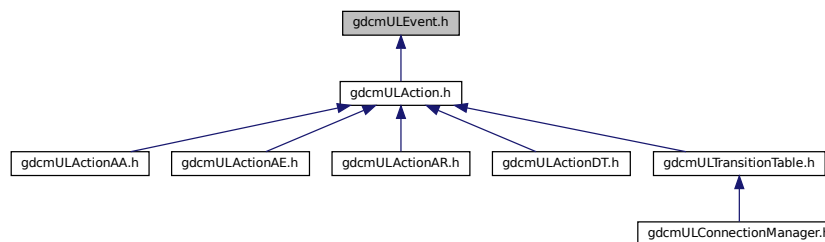



## Classes

- class [gdcml::network::ULEvent](#)  
*ULEvent.*

## Namespaces

- [gdcml](#)
- [gdcml::network](#)

## 11.275 gdcmlTransitionTable.h File Reference

```
#include "gdcmlNetworkStateID.h"
#include "gdcmlNetworkEvents.h"
#include "gdcmlULAction.h"
#include <cstdlib>
```

Include dependency graph for gdcmlTransitionTable.h:

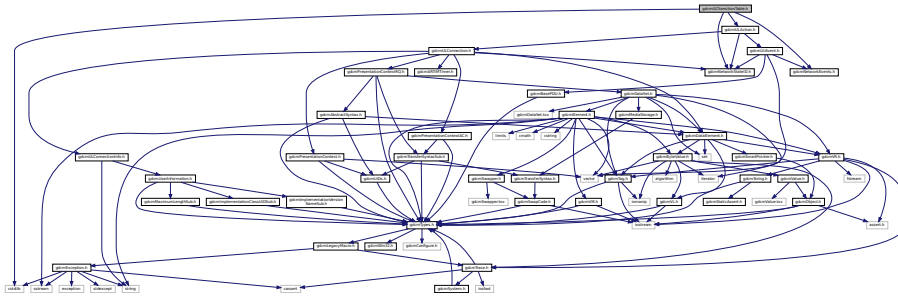

This graph shows which files directly or indirectly include this file:

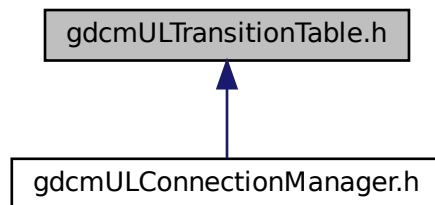

## Classes

- class [gdcm::network::TableRow](#)
- struct [gdcm::network::Transition](#)
- class [gdcm::network::ULTransitionTable](#)

*ULTransitionTable* The transition table of all the ULEvents, new ULActions, and ULStates.

## Namespaces

- [gdcm](#)
- [gdcm::network](#)

## 11.276 gdcmULWritingCallback.h File Reference

```
#include "gdcmULConnectionCallback.h"
```

Include dependency graph for gdcmULWritingCallback.h:

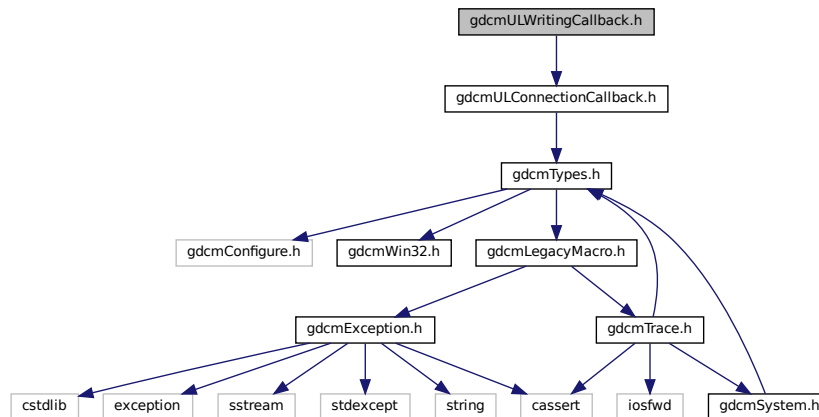

## Classes

- class [gdcm::network::ULWritingCallback](#)

## Namespaces

- [gdcm](#)
- [gdcm::network](#)

## 11.277 gdcmUNExplicitDataElement.h File Reference

```
#include "gdcmDataElement.h"
#include "gdcmUNExplicitDataElement.txx"
Include dependency graph for gdcmUNExplicitDataElement.h:
```

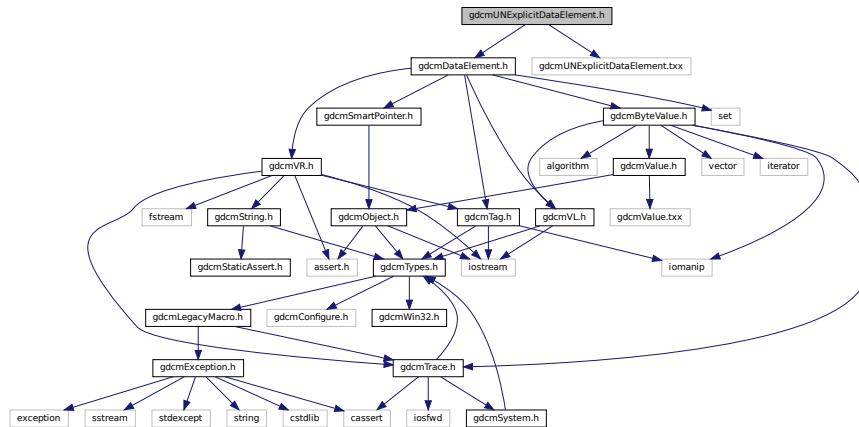

### Classes

- class [gdcm::UNExplicitDataElement](#)  
Class to read/write a *DataElement* as *UNExplicit Data Element*.

### Namespaces

- [gdcm](#)

## 11.278 gdcmUNExplicitImplicitDataElement.h File Reference

```
#include "gdcmDataElement.h"
#include "gdcmUNExplicitImplicitDataElement.txx"
```

Include dependency graph for `gdcмUNExplicitImplicitDataElement.h`:

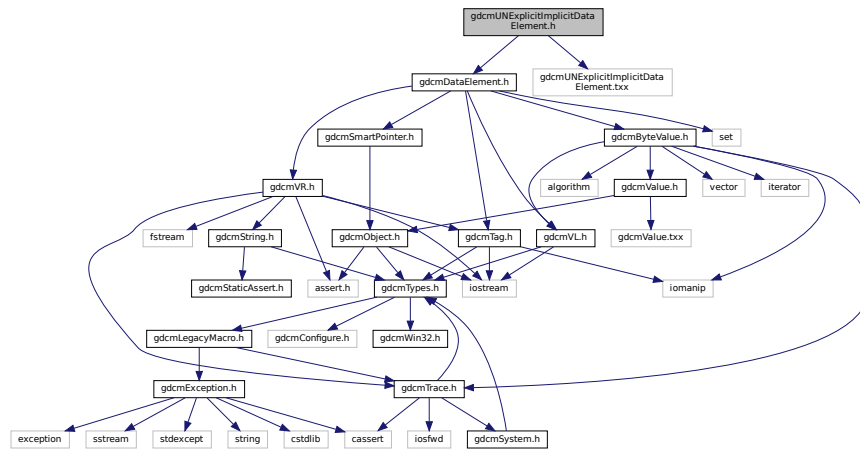

## Classes

- class `gdcм::UNExplicitImplicitDataElement`  
*Class to read/write a `DataElement` as `ExplicitImplicit Data Element`.*

## Namespaces

- `gdcм`

## 11.279 gdcмUnpacker12Bits.h File Reference

```
#include "gdcмTypes.h"
```

Include dependency graph for `gdcмUnpacker12Bits.h`:

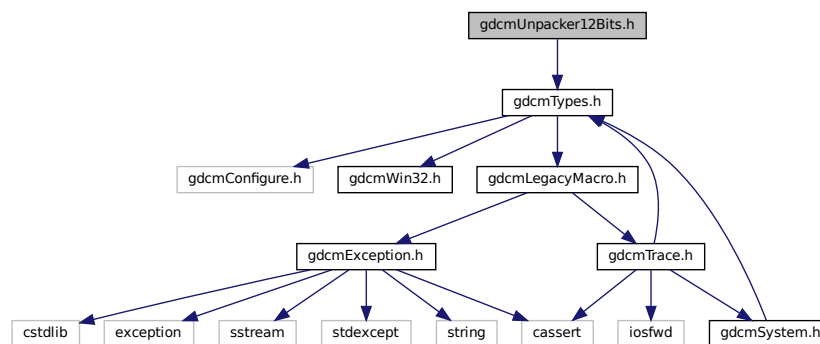

## Classes

- class [gdc::Unpacker12Bits](#)  
*Pack/Unpack 12 bits pixel into 16bits.*

## Namespaces

- [gdc](#)

## 11.280 gdcUsage.h File Reference

```
#include "gdcTypes.h"
```

```
#include <iostream>
```

Include dependency graph for gdcUsage.h:

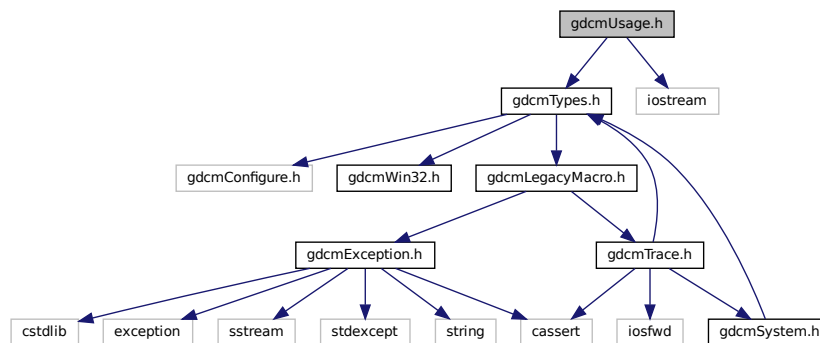

This graph shows which files directly or indirectly include this file:

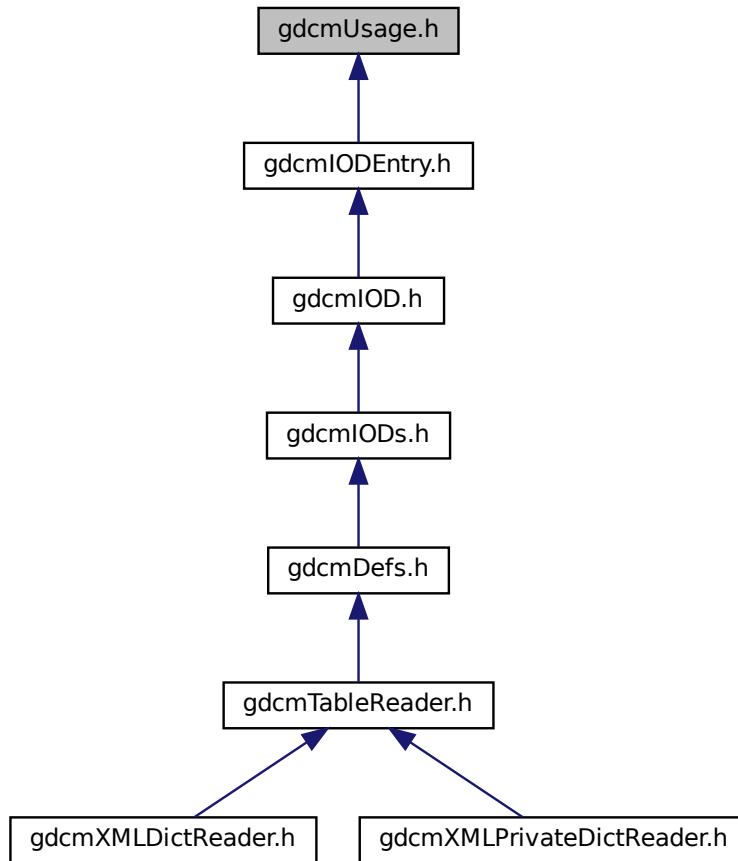

## Classes

- class [gdcml::Usage](#)  
*Usage.*

## Namespaces

- [gdcml](#)

## Functions

- `std::ostream & gdcml::operator<< (std::ostream &_os, const Usage &val)`

## 11.281 gdcmUserInformation.h File Reference

```
#include "gdcmTypes.h"
#include "gdcmMaximumLengthSub.h"
#include "gdcmImplementationVersionNameSub.h"
#include "gdcmImplementationClassUIDSub.h"
```

Include dependency graph for gdcmUserInformation.h:

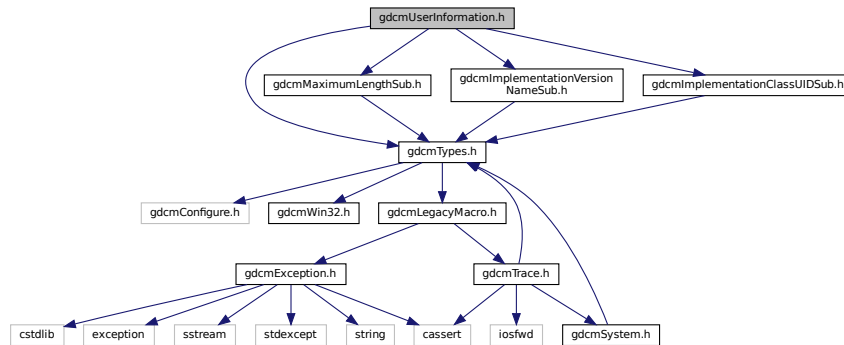

This graph shows which files directly or indirectly include this file:

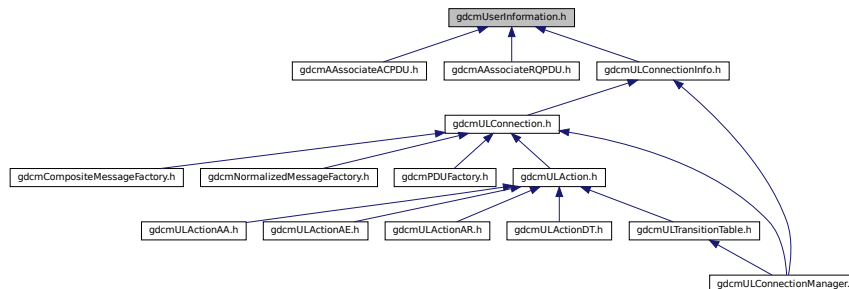

### Classes

- class [gdcm::network::UserInformation](#)  
*UserInformation.*

### Namespaces

- [gdcm](#)
- [gdcm::network](#)





## Classes

- class [gdcm::Validate](#)  
*Validate* class.

## Namespaces

- [gdcm](#)

## 11.284 gdcValue.h File Reference

```
#include "gdcObject.h"
#include "gdcValue.txx"
Include dependency graph for gdcValue.h:
```

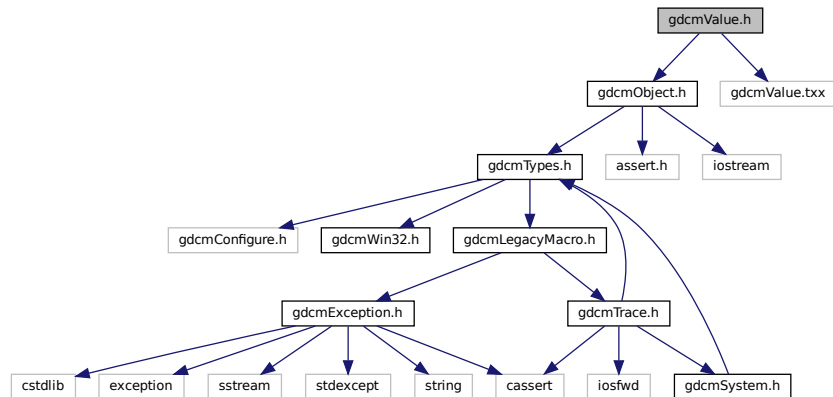

This graph shows which files directly or indirectly include this file:

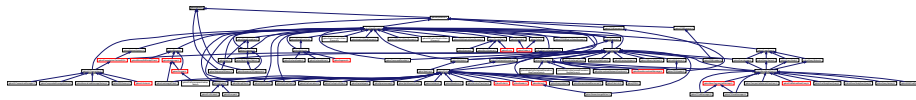

## Classes

- class [gdcm::Value](#)  
*Class to represent the value of a Data [Element](#).*

## Namespaces

- [gdcm](#)

## 11.285 gdcmValueIO.h File Reference

```
#include "gdcmTypes.h"
#include "gdcmValueIO.txx"
Include dependency graph for gdcmValueIO.h:
```

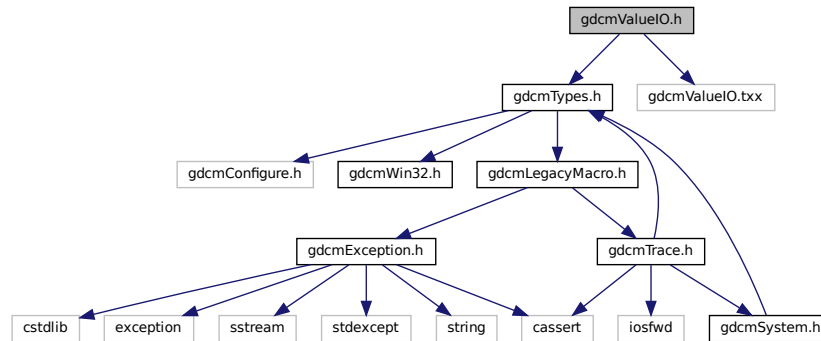

### Classes

- class [gdcm::ValueIO< TDE, TSwap, TType >](#)  
*Class to dispatch template calls.*

### Namespaces

- [gdcm](#)

## 11.286 gdcmVersion.h File Reference

```
#include "gdcmTypes.h"
#include <iostream>
Include dependency graph for gdcmVersion.h:
```

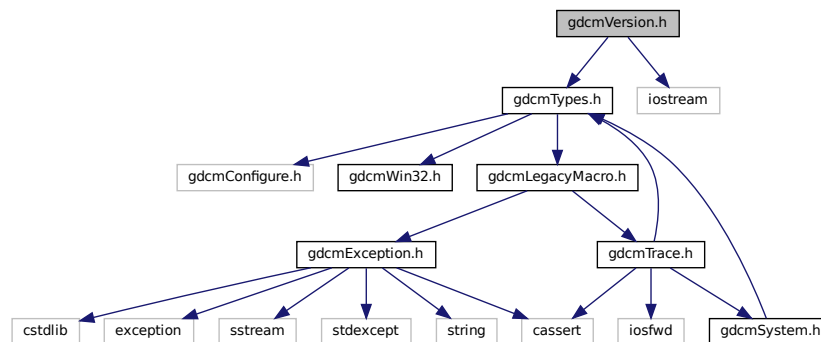

## Classes

- class [gdc::Version](#)  
major/minor and build version

## Namespaces

- [gdc](#)

## Functions

- std::ostream & [gdc::operator<<](#) (std::ostream &os, const Version &v)

## 11.287 gdcVL.h File Reference

```
#include "gdcTypes.h"
#include <iostream>
Include dependency graph for gdcVL.h:
```

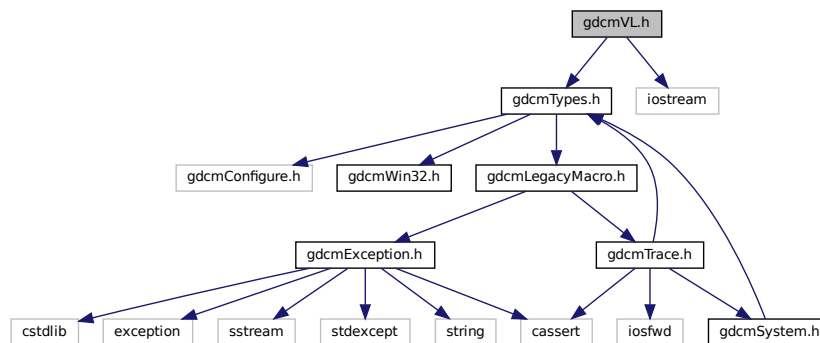

This graph shows which files directly or indirectly include this file:

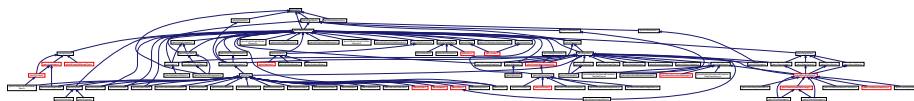

## Classes

- class [gdc::VL](#)  
*Value Length.*

## Namespaces

- [gdcm](#)

## Functions

- `std::ostream & gdcm::operator<< (std::ostream &os, const VL &val)`

## 11.288 gdcmVM.h File Reference

```
#include "gdcmTypes.h"
```

```
#include <iostream>
```

Include dependency graph for gdcmVM.h:

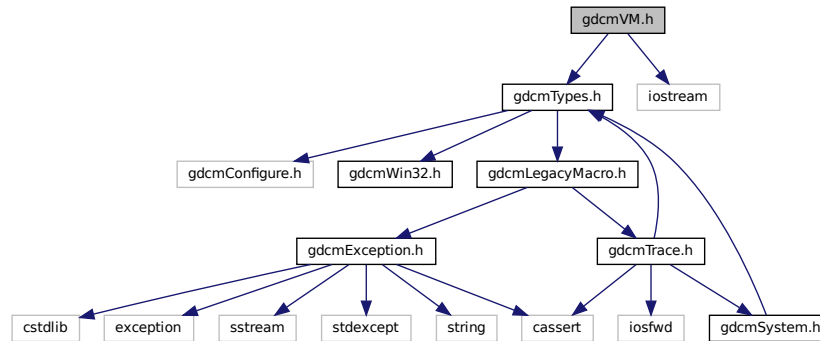

This graph shows which files directly or indirectly include this file:



## Classes

- class [gdcm::VM](#)

*Value Multiplicity Looking at the DICOMV3 dict only there is very few cases: 1 2 3 4 5 6 8 16 24 1-2 1-3 1-8 1-32 1-99 1-n 2-2n 2-n 3-3n 3-n.*

## Namespaces

- [gdcm](#)

## Macros

- #define `TYPETOLENGTH`(type, length)

## Functions

- `std::ostream & gdc::operator<<` (std::ostream &\_os, const VM &\_val)

### 11.288.1 Macro Definition Documentation

#### 11.288.1.1 TYPETOLENGTH

```
#define TYPETOLENGTH(
    type,
    length )
```

#### Value:

```
template<> struct VMToLength<VM::type> \
{ enum { Length = length }; };
```

## 11.289 gdc VR.h File Reference

```
#include "gdcTag.h"
#include "gdcTrace.h"
#include "gdcString.h"
#include <iostream>
#include <fstream>
#include <assert.h>
```

Include dependency graph for gdc VR.h:

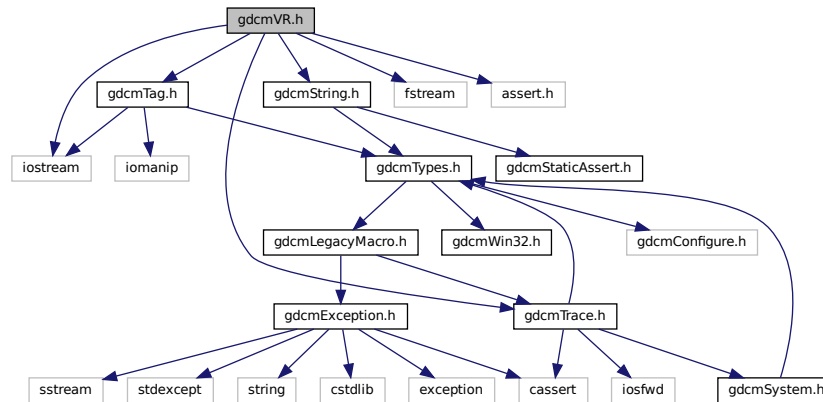

This graph shows which files directly or indirectly include this file:

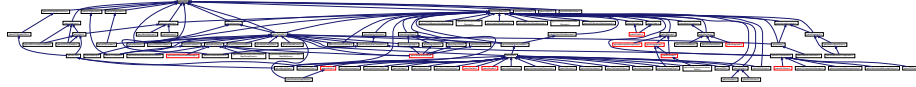

## Classes

- struct [gdcm::UI](#)
- class [gdcm::VR](#)  
*VR class.*

## Namespaces

- [gdcm](#)

## Macros

- #define [TYPETOENCODING](#)(type, rep, rtype)
- #define [VRTypeTemplateCase](#)(type)

## Typedefs

- typedef String<'\', 16 > [gdcm::AECComp](#)
- typedef String<'\', 64 > [gdcm::ASComp](#)
- typedef String<'\', 16 > [gdcm::CSCComp](#)
- typedef String<'\', 64 > [gdcm::DAComp](#)
- typedef String<'\', 64 > [gdcm::DTComp](#)
- typedef String<'\', 64 > [gdcm::LOComp](#)
- typedef String<'\', 64 > [gdcm::LTComp](#)
- typedef String<'\', 64 > [gdcm::PNComp](#)
- typedef String<'\', 64 > [gdcm::SHComp](#)
- typedef String<'\', 64 > [gdcm::STComp](#)
- typedef String<'\', 16 > [gdcm::TMComp](#)
- typedef String<'\', 4294967294 > [gdcm::UCComp](#)
- typedef String<'\', 64, 0 > [gdcm::UIComp](#)
- typedef String<'\', 4294967294 > [gdcm::URComp](#)
- typedef String<'\', 64 > [gdcm::UTComp](#)

## Functions

- std::ostream & [gdcm::operator<<](#) (std::ostream &\_os, const UI &\_val)
- std::ostream & [gdcm::operator<<](#) (std::ostream &\_os, const VR &val)
- [gdcm::TYPETOENCODING](#) (SQ, VRBINARY, unsigned char) TYPETOENCODING(UN

## Variables

- [gdcVR16ExplicitDataElement.h](#): `VRBINARY`

## 11.289.1 Macro Definition Documentation

### 11.289.1.1 TYPETOENCODING

```
#define TYPETOENCODING(
    type,
    rep,
    rtype )
```

#### Value:

```
template<> struct VRToEncoding<VR::type> \
{ enum:long long { Mode = VR::rep }; }; \
template<> struct VRToType<VR::type> \
{ typedef rtype Type; };
```

### 11.289.1.2 VRTypeTemplateCase

```
#define VRTypeTemplateCase(
    type )
```

#### Value:

```
case VR::type: \
return sizeof ( VRToType<VR::type>::Type );
```

## 11.290 gdcVR16ExplicitDataElement.h File Reference

```
#include "gdcDataElement.h"
#include "gdcVR16ExplicitDataElement.txx"
Include dependency graph for gdcVR16ExplicitDataElement.h:
```

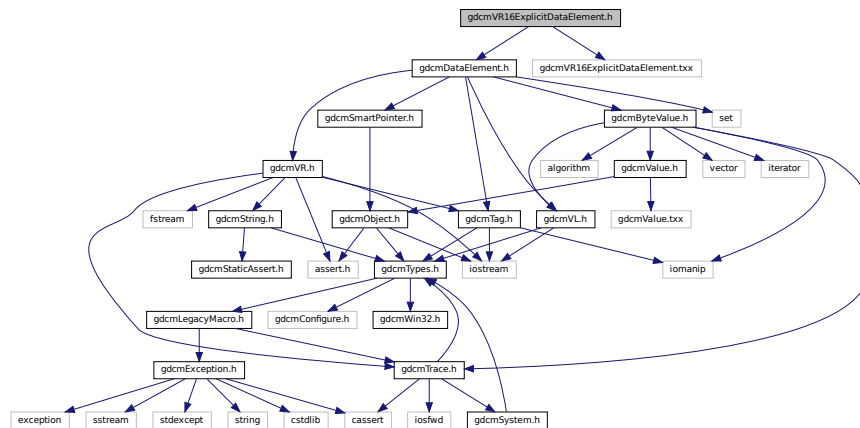

## Classes

- class [gdcm::VR16ExplicitDataElement](#)  
Class to read/write a *DataElement* as *Explicit Data Element*.

## Namespaces

- [gdcm](#)

## 11.291 gdcmWaveform.h File Reference

```
#include "gdcmFile.h"
```

Include dependency graph for gdcmWaveform.h:

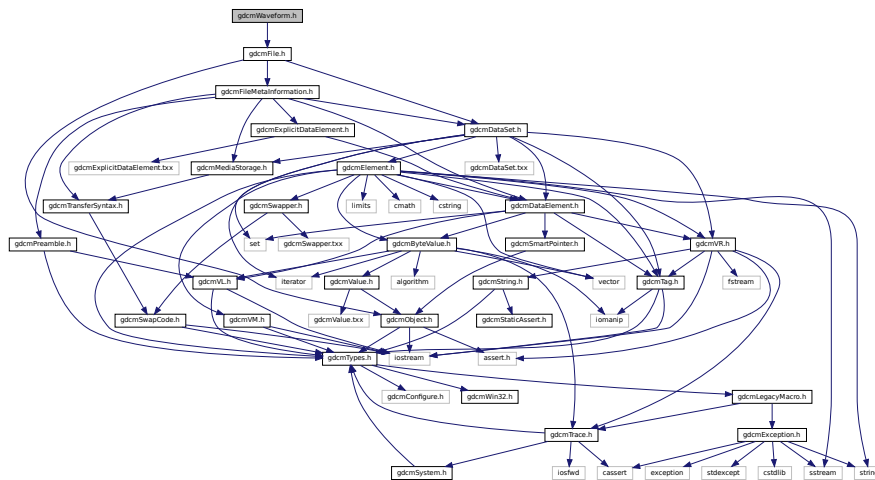

## Classes

- class [gdcm::Waveform](#)  
*Waveform* class.

## Namespaces

- [gdcm](#)

## 11.292 gdcmWin32.h File Reference

This graph shows which files directly or indirectly include this file:





## Macros

- #define [GDCM\\_EXPORT](#)

## 11.292.1 Macro Definition Documentation

### 11.292.1.1 GDCM\_EXPORT

```
#define GDCM_EXPORT
```

## 11.293 gdcmlWLMFindQuery.h File Reference

```
#include "gdcmlBaseRootQuery.h"
```

Include dependency graph for gdcmlWLMFindQuery.h:

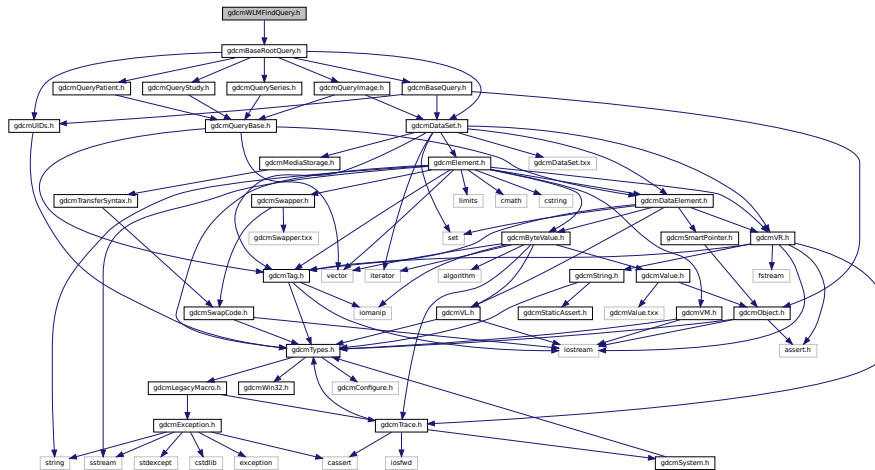

## Classes

- class [gdcml::WLMFindQuery](#)  
*PatientRootQuery.*

## Namespaces

- [gdcml](#)

## 11.294 gdcWriter.h File Reference

```
#include "gdcFile.h"
```

Include dependency graph for gdcWriter.h:

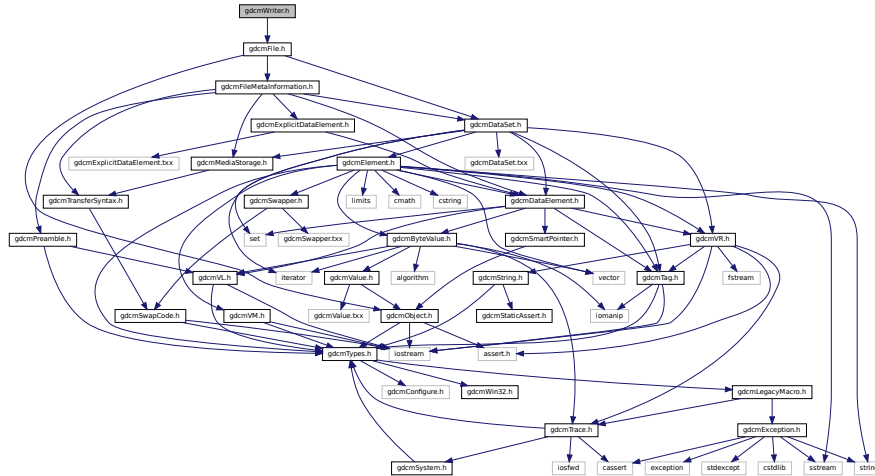

This graph shows which files directly or indirectly include this file:

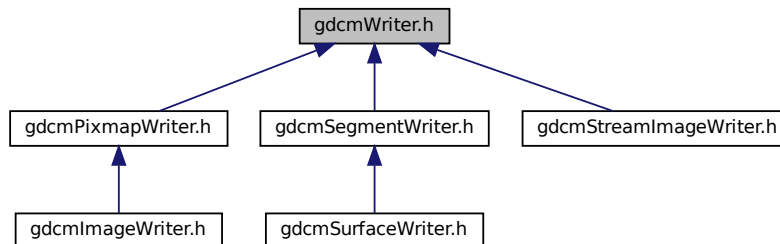

### Classes

- class [gdcm::Writer](#)  
*Writer* *ala* DOM (*Document Object Model*)

### Namespaces

- [gdcm](#)

## 11.295 gdcmXMLDictReader.h File Reference

```
#include "gdcmTableReader.h"
#include "gdcmDict.h"
#include "gdcmDictEntry.h"
#include "gdcmTag.h"
```

Include dependency graph for gdcmXMLDictReader.h:

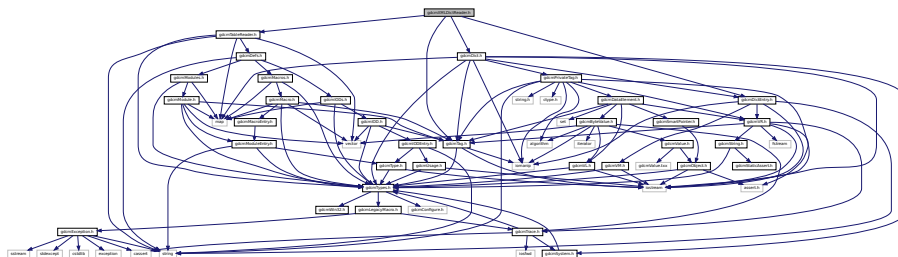

### Classes

- class [gdcm::XMLDictReader](#)  
*Class for representing a [XMLDictReader](#).*

### Namespaces

- [gdcm](#)

## 11.296 gdcmXMLPrinter.h File Reference

```
#include "gdcmFile.h"
#include "gdcmDataElement.h"
```

Include dependency graph for gdcmXMLPrinter.h:

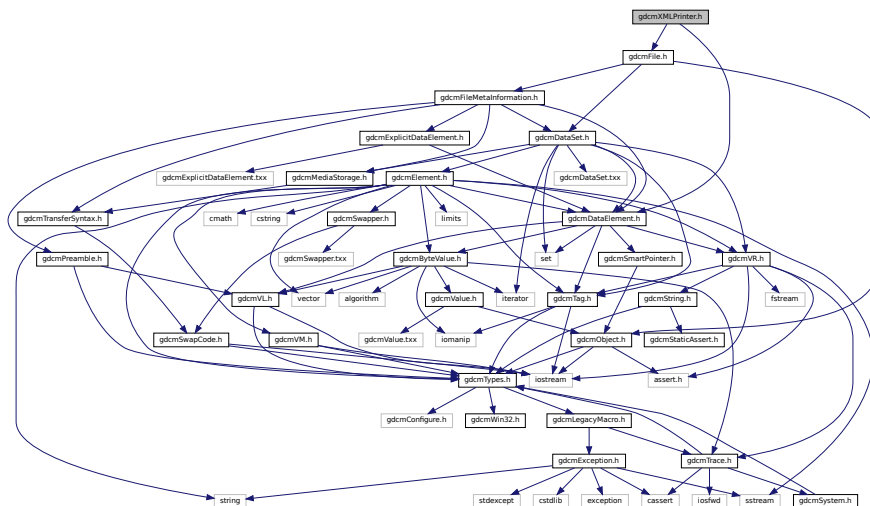

## Classes

- class [gdcm::XMLPrinter](#)

## Namespaces

- [gdcm](#)

## 11.297 gdcmXMLPrivateDictReader.h File Reference

```
#include "gdcmTableReader.h"
#include "gdcmDict.h"
#include "gdcmDictEntry.h"
#include "gdcmTag.h"
```

Include dependency graph for gdcmXMLPrivateDictReader.h:

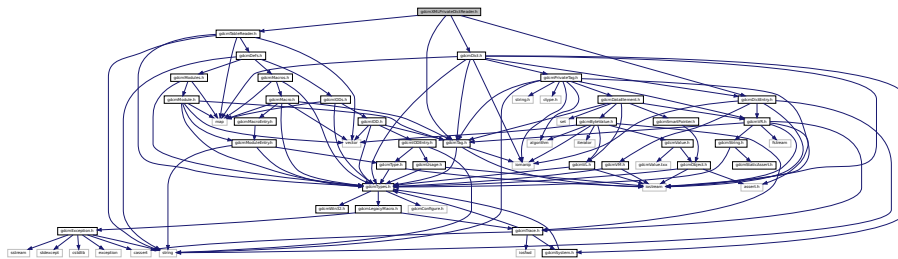

## Classes

- class [gdcm::XMLPrivateDictReader](#)  
*Class for representing a XMLPrivateDictReader.*

## Namespaces

- [gdcm](#)

## 11.298 README.txt File Reference

## 11.299 TestsList.txt File Reference

## 11.300 vtkGDCMImageReader.h File Reference

```
#include "vtkMedicalImageReader2.h"  
#include "vtkImageData.h"  
#include "vtkVersion.h"  
Include dependency graph for vtkGDCMImageReader.h:
```

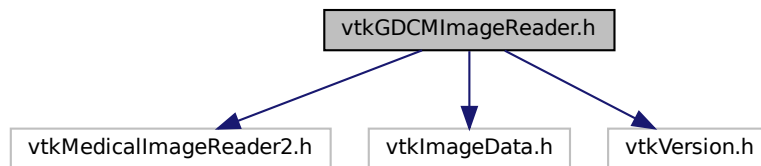

This graph shows which files directly or indirectly include this file:

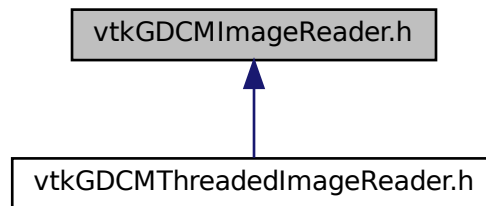

### Classes

- class [vtkGDCMImageReader](#)

### Namespaces

- [gdc](#)

## Macros

- `#define VTK_CMYK 8`
- `#define VTK_INVERSE_LUMINANCE 5`
- `#define VTK_LOOKUP_TABLE 6`
- `#define VTK_YBR 7`

### 11.300.1 Macro Definition Documentation

#### 11.300.1.1 VTK\_CMYK

```
#define VTK_CMYK 8
```

#### 11.300.1.2 VTK\_INVERSE\_LUMINANCE

```
#define VTK_INVERSE_LUMINANCE 5
```

#### 11.300.1.3 VTK\_LOOKUP\_TABLE

```
#define VTK_LOOKUP_TABLE 6
```

#### 11.300.1.4 VTK\_YBR

```
#define VTK_YBR 7
```

## 11.301 vtkGDCMImageReader2.h File Reference

```
#include "vtkMedicalImageReader2.h"  
#include "vtkImageData.h"  
Include dependency graph for vtkGDCMImageReader2.h:
```

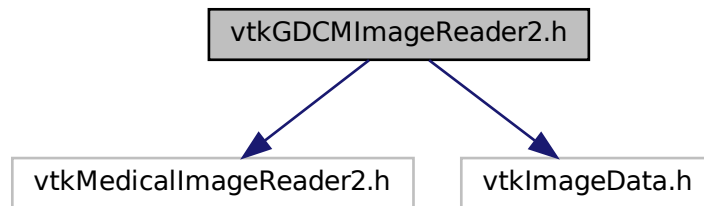

### Classes

- class [vtkGDCMImageReader2](#)

### Namespaces

- [gdc](#)

### Macros

- `#define VTK_CMYK` 8
- `#define VTK_INVERSE_LUMINANCE` 5
- `#define VTK_LOOKUP_TABLE` 6
- `#define VTK_YBR` 7

### 11.301.1 Macro Definition Documentation

#### 11.301.1.1 VTK\_CMYK

```
#define VTK_CMYK 8
```

### 11.301.1.2 VTK\_INVERSE\_LUMINANCE

```
#define VTK_INVERSE_LUMINANCE 5
```

### 11.301.1.3 VTK\_LOOKUP\_TABLE

```
#define VTK_LOOKUP_TABLE 6
```

### 11.301.1.4 VTK\_YBR

```
#define VTK_YBR 7
```

## 11.302 vtkGDCMImageWriter.h File Reference

```
#include "vtkImageWriter.h"
```

```
#include "vtkVersion.h"
```

Include dependency graph for vtkGDCMImageWriter.h:

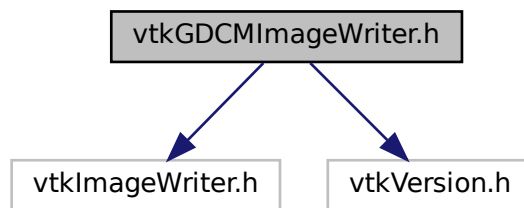

## Classes

- class [vtkGDCMImageWriter](#)



## 11.303 vtkGDCMMedicalImageProperties.h File Reference

```
#include "vtkMedicalImageProperties.h"
```

Include dependency graph for vtkGDCMMedicalImageProperties.h:

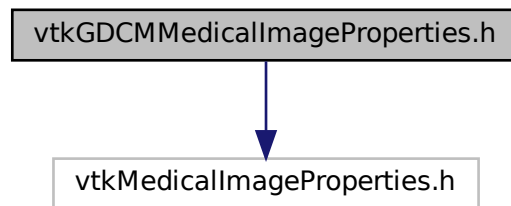

### Classes

- class [vtkGDCMMedicalImageProperties](#)

### Namespaces

- [gdc](#)

## 11.304 vtkGDCMPolyDataReader.h File Reference

```
#include "vtkPolyDataAlgorithm.h"
```

Include dependency graph for vtkGDCMPolyDataReader.h:

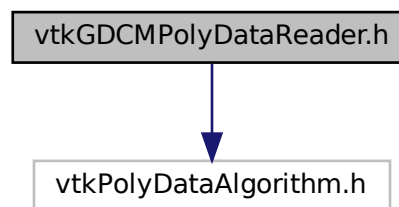

## Classes

- class [vtkGDCMPolyDataReader](#)

## Namespaces

- [gdc](#)

## 11.305 vtkGDCMPolyDataWriter.h File Reference

```
#include "vtkPolyDataWriter.h"  
#include "vtkStringArray.h"  
#include "vtkStdString.h"  
Include dependency graph for vtkGDCMPolyDataWriter.h:
```

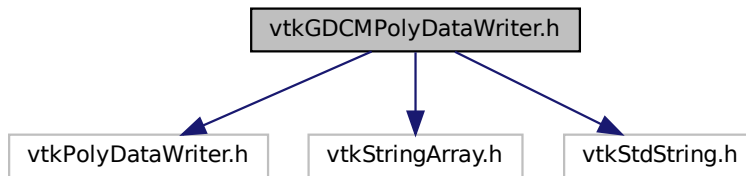

## Classes

- class [vtkGDCMPolyDataWriter](#)

## Namespaces

- [gdc](#)

## 11.306 vtkGDCMTesting.h File Reference

```
#include "vtkObject.h"
```

Include dependency graph for vtkGDCMTesting.h:

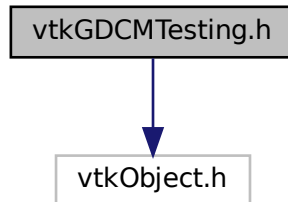

### Classes

- class [vtkGDCMTesting](#)

## 11.307 vtkGDCMThreadedImageReader.h File Reference

```
#include "vtkGDCMImageReader.h"
```

```
#include "vtkVersion.h"
```

Include dependency graph for vtkGDCMThreadedImageReader.h:

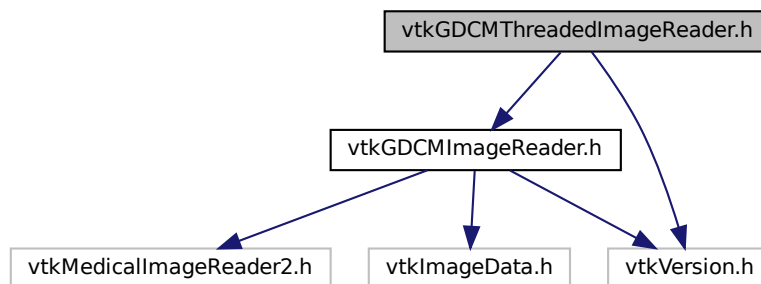

### Classes

- class [vtkGDCMThreadedImageReader](#)

## 11.308 vtkGDCMThreadedImageReader2.h File Reference

```
#include "vtkThreadedImageAlgorithm.h"
```

Include dependency graph for vtkGDCMThreadedImageReader2.h:

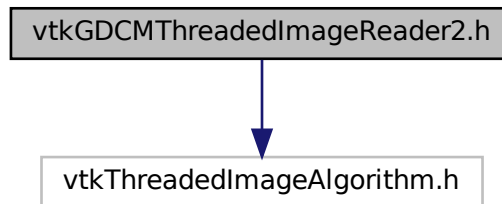

### Classes

- class [vtkGDCMThreadedImageReader2](#)

## 11.309 vtkImageColorViewer.h File Reference

```
#include "vtkObject.h"
```

```
#include "vtkVersion.h"
```

Include dependency graph for vtkImageColorViewer.h:

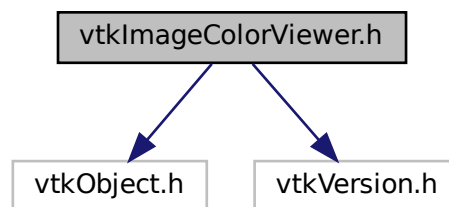

### Classes

- class [vtkImageColorViewer](#)

## 11.310 vtkImageMapToColors16.h File Reference

```
#include "vtkThreadedImageAlgorithm.h"  
Include dependency graph for vtkImageMapToColors16.h:
```

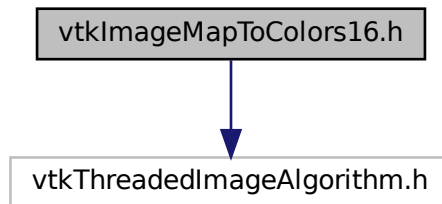

### Classes

- class [vtkImageMapToColors16](#)

## 11.311 vtkImageMapToWindowLevelColors2.h File Reference

```
#include "vtkImageMapToColors.h"  
Include dependency graph for vtkImageMapToWindowLevelColors2.h:
```

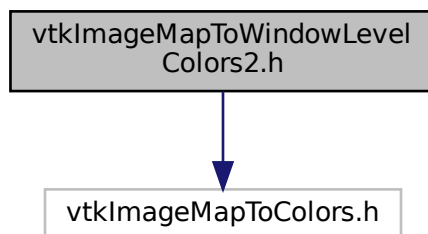

### Classes

- class [vtkImageMapToWindowLevelColors2](#)

## 11.312 vtkImagePlanarComponentsToComponents.h File Reference

```
#include "vtkImageAlgorithm.h"
```

Include dependency graph for vtkImagePlanarComponentsToComponents.h:

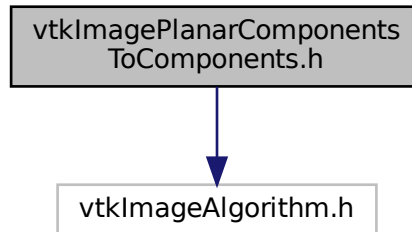

### Classes

- class [vtkImagePlanarComponentsToComponents](#)

## 11.313 vtkImageRGBToYBR.h File Reference

```
#include "vtkThreadedImageAlgorithm.h"
```

Include dependency graph for vtkImageRGBToYBR.h:

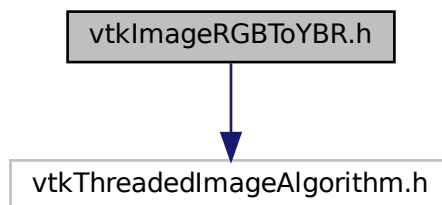

### Classes

- class [vtkImageRGBToYBR](#)

## 11.314 vtkImageYBRToRGB.h File Reference

```
#include "vtkThreadedImageAlgorithm.h"  
Include dependency graph for vtkImageYBRToRGB.h:
```

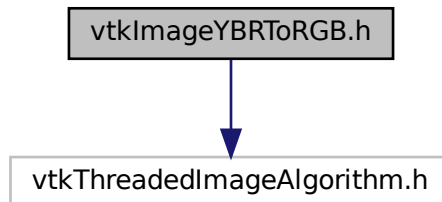

### Classes

- class [vtkImageYBRToRGB](#)

## 11.315 vtkLookupTable16.h File Reference

```
#include "vtkLookupTable.h"  
#include "vtkUnsignedShortArray.h"  
Include dependency graph for vtkLookupTable16.h:
```

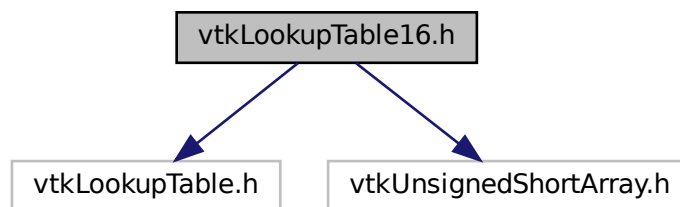

### Classes

- class [vtkLookupTable16](#)

## 11.316 vtkRTStructSetProperties.h File Reference

```
#include "vtkObject.h"
```

Include dependency graph for vtkRTStructSetProperties.h:

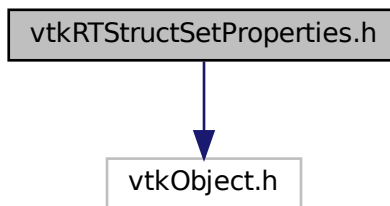

### Classes

- class [vtkRTStructSetProperties](#)



## Chapter 12

# Example Documentation

### 12.1 TestByteSwap.cxx

This is a C++ example on how to use [gdcm::ByteSwap](#)

```
/*=====
Program: GDCM (Grassroots DICOM). A DICOM library

Copyright (c) 2006-2011 Mathieu Malaterre
All rights reserved.
See Copyright.txt or http://gdcm.sourceforge.net/Copyright.html for details.

This software is distributed WITHOUT ANY WARRANTY; without even
the implied warranty of MERCHANTABILITY or FITNESS FOR A PARTICULAR
PURPOSE. See the above copyright notice for more information.

=====*/
#include "gdcmTypes.h"
#include "gdcmSwapCode.h"
#include "gdcmByteSwap.h"
#include <string.h> // memcpy
int myfunc()
{
    char vl_str[4];
    const char raw[] = "\000\000\000\004";
    memcpy(vl_str, raw, 4);
    uint32_t vl;
    gdcm::ByteSwap<uint32_t>::SwapRangeFromSwapCodeIntoSystem((uint32_t*)&vl_str, gdcm::SwapCode::BigEndian, 1);
    memcpy(&vl, vl_str, 4);
    if( vl != 0x00000004 )
    {
        std::cerr << std::hex << "vl: " << vl << std::endl;
        return 1;
    }
    gdcm::ByteSwap<uint32_t>::SwapFromSwapCodeIntoSystem(vl, gdcm::SwapCode::LittleEndian);
    if( vl != 0x00000004 )
    {
        std::cerr << std::hex << "vl: " << vl << std::endl;
        return 1;
    }
    gdcm::ByteSwap<uint32_t>::SwapFromSwapCodeIntoSystem(vl, gdcm::SwapCode::BigEndian);
    if( vl != 0x40000000 )
    {
        std::cerr << std::hex << "vl: " << vl << std::endl;
        return 1;
    }
    return 0;
}
int TestByteSwap(int , char *[])
{
    gdcm::SwapCode sc = gdcm::SwapCode::Unknown;
    if ( gdcm::ByteSwap<uint16_t>::SystemIsBigEndian() )
```

```

    {
        sc = gdc::SwapCode::BigEndian;
    }
else if ( gdc::ByteSwap<uint16_t>::SystemIsLittleEndian() )
    {
        sc = gdc::SwapCode::LittleEndian;
    }
if( sc == gdc::SwapCode::Unknown )
    {
        std::cerr << "unk" << std::endl;
        return 1;
    }
//std::cout << "sc: " << sc << std::endl;
uint16_t t = 0x1234;
gdc::ByteSwap<uint16_t>::SwapFromSwapCodeIntoSystem(t, sc);
if( sc == gdc::SwapCode::BigEndian )
    {
        if( t != 0x3412 )
            {
                std::cerr << std::hex << "t: " << t << std::endl;
                return 1;
            }
        // ok test pass rest value to old one
        t = 0x1234;
    }
else if ( sc == gdc::SwapCode::LittleEndian )
    {
        if( t != 0x1234 )
            {
                std::cerr << std::hex << "t: " << t << std::endl;
                return 1;
            }
    }
union { char n[2]; uint16_t tn; } u16;
memcpy(u16.n, &t, 2 );
gdc::ByteSwap<uint16_t>::SwapRangeFromSwapCodeIntoSystem(&u16.tn, sc, 1);
uint16_t tn = u16.tn;
if( sc == gdc::SwapCode::BigEndian )
    {
        if( tn != 0x3412 )
            {
                std::cerr << std::hex << "tn: " << tn << std::endl;
                return 1;
            }
        // ok test pass rest value to old one
        t = 0x1234;
    }
else if ( sc == gdc::SwapCode::LittleEndian )
    {
        if( tn != 0x1234 )
            {
                std::cerr << std::hex << "tn: " << tn << std::endl;
                return 1;
            }
    }
gdc::ByteSwap<uint16_t>::SwapRangeFromSwapCodeIntoSystem(&u16.tn, gdc::SwapCode::BigEndian, 1);
tn = u16.tn;
if( sc == gdc::SwapCode::LittleEndian )
    {
        if( tn != 0x3412 )
            {
                std::cerr << std::hex << "tn: " << tn << std::endl;
                return 1;
            }
    }
else if ( sc == gdc::SwapCode::BigEndian )
    {
        if( tn != 0x1234 )
            {
                std::cerr << std::hex << "tn: " << tn << std::endl;
                return 1;
            }
    }
}
if( myfunc() )
    {
        return 1;
    }
uint16_t array[] = { 0x1234 };
gdc::ByteSwap<uint16_t>::SwapRangeFromSwapCodeIntoSystem(array,
    gdc::SwapCode::BigEndian,1);
if ( array[0] != 0x3412 )

```

```

    {
        std::cerr << std::hex << "array: " << array[0] << std::endl;
        return 1;
    }
    return 0;
}

```

## 12.2 PatchFile.cxx

This is a C++ example on how to use [gdcm::Attribute](#)

```

/*=====
Program: GDCM (Grassroots DICOM). A DICOM library

Copyright (c) 2006-2011 Mathieu Malaterre
All rights reserved.
See Copyright.txt or http://gdcm.sourceforge.net/Copyright.html for details.

This software is distributed WITHOUT ANY WARRANTY; without even
the implied warranty of MERCHANTABILITY or FITNESS FOR A PARTICULAR
PURPOSE. See the above copyright notice for more information.

=====*/
/*
 * The image was a broken file where the Pixel Data element was 8 times too big
 * Apparently multiplying the BitsAllocated to 4 and multiplying the number of
 * frames by 2 would solve the problem
 *
 * This C++ code can be used to patch the header.
 */
#include "gdcmReader.h"
#include "gdcmImageReader.h"
#include "gdcmWriter.h"
#include "gdcmDataSet.h"
#include "gdcmAttribute.h"
int main(int argc, char *argv[])
{
    if( argc < 3 )
    {
        return 1;
    }
    const char *f = argv[1];
    const char *out = argv[2];
    gdcm::Reader r;
    r.SetFileName( f );
    if( !r.Read() )
    {
        return 1;
    }
    gdcm::File &file = r.GetFile();
    gdcm::DataSet& ds = file.GetDataSet();
    // (0028,0100) US 16 # 2, 1 BitsAllocated
    // (0028,0101) US 16 # 2, 1 BitsStored
    // (0028,0102) US 15 # 2, 1 HighBit
    //
    {
        gdcm::Attribute<0x28,0x100> at;
        at.SetFromDataElement( ds.GetDataElement( at.GetTag() ) );
        if( at.GetValue() != 8 )
        {
            return 1;
        }
        at.SetValue( 32 );
        ds.Replace( at.GetAsDataElement() );
    }
    {
        gdcm::Attribute<0x28,0x101> at;
        at.SetFromDataElement( ds.GetDataElement( at.GetTag() ) );
        if( at.GetValue() != 8 )
        {
            return 1;
        }
        at.SetValue( 32 );
        ds.Replace( at.GetAsDataElement() );
    }
}

```

```

{
    gdcmm::Attribute<0x28,0x102> at;
    at.SetFromDataElement( ds.GetDataElement( at.GetTag() ) );
    if( at.GetValue() != 7 )
    {
        return 1;
    }
    at.SetValue( 31 );
    ds.Replace( at.GetAsDataElement() );
}
// (0028,0008) IS [56] # 2, 1 NumberOfFrames
{
    gdcmm::Attribute<0x28,0x8> at;
    at.SetFromDataElement( ds.GetDataElement( at.GetTag() ) );
    at.SetValue( at.GetValue() * 2 );
    ds.Replace( at.GetAsDataElement() );
}
gdcmm::Writer w;
w.SetFile( file );
w.SetCheckFileMetaInformation( false );
w.SetFileName( out );
if( !w.Write() )
{
    return 1;
}
// Now let's see if we can read it as an image:
gdcmm::ImageReader ir;
ir.SetFileName( out );
if(!ir.Read())
{
    return 1;
}
gdcmm::Image &image = ir.GetImage();
unsigned long len = image.GetBufferLength();
const gdcmm::ByteValue *bv = ir.GetFile().GetDataSet().GetDataElement( gdcmm::Tag(0x7fe0,0x0010)
    ).GetByteValue();
if( !bv || len != bv->GetLength() )
{
    return 1;
}
std::cout << bv->GetLength() << " " << len << std::endl;
std::cout << "Success to rewrite image !" << std::endl;
image.Print( std::cout );
return 0;
}

```

## 12.3 SimplePrint.cs

This is a C# example on how to use gdcmm::SWIGDataSet

```

/*=====
Program: GDCM (Grassroots DICOM). A DICOM library

Copyright (c) 2006-2011 Mathieu Malaterre
All rights reserved.
See Copyright.txt or http://gdcmm.sourceforge.net/Copyright.html for details.

This software is distributed WITHOUT ANY WARRANTY; without even
the implied warranty of MERCHANTABILITY or FITNESS FOR A PARTICULAR
PURPOSE. See the above copyright notice for more information.

=====*/
/*
 * Converter convertor = new Converter();
 * int a = convertor.Convert<int>( some_int_blob );
 * double b = convertor.Convert<double>( some_double_blob );
 */
/*
 * Usage:
 * $ export LD_LIBRARY_PATH=$HOME/Projects/gdcmm/debug-gcc/bin
 * $ mono bin/SimplePrint.exe gdcmmData/012345.002.050.dcm
 */
using System;
using gdcmm;
public class SimplePrint

```

```

{
public static void RecurseDataSet(File f, DataSet ds, string indent)
{
    CSharpDataSet cds = new CSharpDataSet(ds);
    while(!cds.IsAtEnd())
    {
        DataElement de = cds.GetCurrent();
        // Compute VR from the toplevel file, and the currently processed dataset:
        VR vr = DataSetHelper.ComputeVR(f, ds, de.GetTag() );
        if( vr.Compatible( new VR(VR.VRType.SQ) ) )
        {
            uint uvl = (uint)de.GetVL(); // Test cast is ok
            System.Console.WriteLine( indent + de.GetTag().toString() + ":" + uvl ); // why not ?
            //SequenceOfItems sq = de.GetSequenceOfItems();
            // GetValueAsSQ handle more cases than GetSequenceOfItems
            SmartPtrSQ sq = de.GetValueAsSQ();
            uint n = sq.GetNumberOfItems();
            for( uint i = 1; i <= n; i++) // item starts at 1, not 0
            {
                Item item = sq.GetItem( i );
                DataSet nested = item.GetNestedDataSet();
                RecurseDataSet( f, nested, indent + "  " );
            }
        }
        else
        {
            System.Console.WriteLine( indent + de.toString() );
        }
        cds.Next();
    }
}

public static int Main(string[] args)
{
    string filename = args[0];
    Reader reader = new Reader();
    reader.SetFileName( filename );
    bool ret = reader.Read();
    if( !ret )
    {
        return 1;
    }
    File f = reader.GetFile();
    DataSet ds = f.GetDataSet();
    RecurseDataSet( f, ds, "" );
    return 0;
}
}

```

## 12.4 TestReader.cxx

```

/*=====
Program: GDCM (Grassroots DICOM). A DICOM library

Copyright (c) 2006-2011 Mathieu Malaterre
All rights reserved.
See Copyright.txt or http://gdcm.sourceforge.net/Copyright.html for details.

This software is distributed WITHOUT ANY WARRANTY; without even
the implied warranty of MERCHANTABILITY or FITNESS FOR A PARTICULAR
PURPOSE. See the above copyright notice for more information.

=====*/
#include "gdcmReader.h"
#include "gdcmFileMetaInformation.h"
#include "gdcmFile.h"
#include "gdcmTesting.h"
#include "gdcmMediaStorage.h"
int TestRead(const char* filename, bool verbose = false)
{
    if( verbose )
        std::cout << "TestRead: " << filename << std::endl;
    gdcm::Reader reader;
    reader.SetFileName( filename );
    if ( !reader.Read() )
    {
        std::cerr << "TestReadError: Failed to read: " << filename << std::endl;
    }
}

```

```

        return 1;
    }
//commenting out the fmi and ds to avoid warnings
//const gdcm::FileMetaInformation &h = reader.GetFile().GetHeader();
//std::cout << h << std::endl;
//const gdcm::DataSet &ds = reader.GetFile().GetDataSet();
//std::cout << ds << std::endl;
const char *ref = gdcm::Testing::GetMediaStorageFromFile(filename);
gdcm::MediaStorage ms;
ms.SetFromFile( reader.GetFile() );
if( !ref )
{
    std::cerr << "TestReadError: Missing MediaStorage: " << filename << std::endl;
    std::cerr << "It should be: " << ms << std::endl;
    return 1;
}
if( ms.IsUndefined() && ref && *ref != 0 )
{
    std::cerr << "TestReadError: MediaStorage: " << filename << std::endl;
    std::cerr << "It should be instead: " << ref << std::endl;
    return 1;
}
// Make sure it is the right one:
if( ref && *ref != 0 && ms != gdcm::MediaStorage::GetMSType(ref) )
{
    std::cerr << "Error: Found MediaStorage: " << ms << " for " << filename << std::endl;
    std::cerr << "It should be instead: " << ref << std::endl;
    return 1;
}
return 0;
}
int TestReader(int argc, char *argv[])
{
    if( argc == 2 )
    {
        const char *filename = argv[1];
        return TestRead(filename, true);
    }
    // else
    gdcm::Trace::DebugOff();
    gdcm::Trace::WarningOff();
    int r = 0, i = 0;
    const char *filename;
    const char * const *filenames = gdcm::Testing::GetFileNames();
    while( (filename = filenames[i]) )
    {
        r += TestRead( filename );
        ++i;
    }
    return r;
}

```

## 12.5 TestReader.py

This is a C++ example on how to use [gdcm::Reader](#)

```

1
14
15 import os,sys
16 import gdcm
17
18 def TestRead(filename, verbose = False):
19     r = gdcm.Reader()
20     r.SetFileName( filename )
21     success = r.Read()
22     #if verbose: print r.GetFile()
23     if verbose: print (r.GetFile().GetDataSet())
24     return success
25
26 if __name__ == "__main__":
27     success = 0
28     try:
29         filename = os.sys.argv[1]
30         success += TestRead( filename, True )
31     except:
32         # loop over all files:

```

```

33     gdcM.Trace.DebugOff()
34     gdcM.Trace.WarningOff()
35     t = gdcM.Testing()
36     nfiles = t.GetNumberOfFileNames()
37     for i in range(0,nfiles):
38         filename = t.GetFileName(i)
39         success += TestRead( filename )
40
41
42     # Test succeed ?
43     sys.exit(success == 0)

```

## 12.6 DecompressJPEGFile.cs

This is a C# example on how to use `gdcM::SequenceOfFragments`

```

/*=====
Program: GDCM (Grassroots DICOM). A DICOM library

Copyright (c) 2006-2011 Mathieu Malaterre
All rights reserved.
See Copyright.txt or http://gdcM.sourceforge.net/Copyright.html for details.

This software is distributed WITHOUT ANY WARRANTY; without even
the implied warranty of MERCHANTABILITY or FITNESS FOR A PARTICULAR
PURPOSE. See the above copyright notice for more information.

=====*/
/*
 * Usage:
 * $ export LD_LIBRARY_PATH=$HOME/Projects/gdcM/debug-gcc/bin
 * $ mono bin/DecompressJPEGFile.exe somejpegfile.jpg
 */
using System;
using gdcM;
public class DecompressJPEGFile
{
    public static int Main(string[] args)
    {
        string file1 = args[0];
        System.IO.FileStream infile =
            new System.IO.FileStream(file1, System.IO.FileMode.Open, System.IO.FileAccess.Read);
        uint fsize = gdcM.PosixEmulation.FileSize(file1);
        byte[] jstream = new byte[fsize];
        infile.Read(jstream, 0 , jstream.Length);
        Trace.DebugOn();
        Image image = new Image();
        image.SetNumberOfDimensions( 2 ); // important for now
        DataElement pixeldata = new DataElement( new gdcM.Tag(0x7fe0,0x0010) );
        // DO NOT set a ByteValue here, JPEG is a particular kind of encapsulated syntax
        // in which can one cannot use a simple byte array for storage. Instead, see
        // gdcM.SequenceOfFragments
        //pixeldata.SetByteValue( jstream, new gdcM.VL( (uint)jstream.Length ) );
        // Create a new SequenceOfFragments C++ object, store it as a SmartPointer :
        SmartPtrFrag sq = SequenceOfFragments.New();
        Fragment frag = new Fragment();
        frag.SetByteValue( jstream, new gdcM.VL( (uint)jstream.Length) );
        // Single file => single fragment
        sq.AddFragment( frag );
        // Pass by reference:
        pixeldata.SetValue( sq.__ref__() );
        // insert:
        image.SetDataElement( pixeldata );
        // JPEG use YBR to achieve better compression ratio by default (not RGB)
        // FIXME hardcoded:
        PhotometricInterpretation pi = new PhotometricInterpretation( PhotometricInterpretation.PIType.YBR_FULL );
        image.SetPhotometricInterpretation( pi );
        // FIXME hardcoded:
        PixelFormat pixeltype = new PixelFormat(3,8,8,7);
        image.SetPixelFormat( pixeltype );
        // FIXME hardcoded:
        image.SetTransferSyntax( new TransferSyntax( TransferSyntax.TSType.JPEGLosslessProcess14_1 ) );
        image.SetDimension(0, 692);
        image.SetDimension(1, 721);
        // Decompress !
    }
}

```

```

byte[] decompressedData = new byte[(int)image.GetBufferLength()];
image.GetBuffer(decompressedData);
// Write out the decompressed bytes
System.Console.WriteLine(image.toString());
using (System.IO.Stream stream =
    System.IO.File.Open(@"tmp/dd.raw",
        System.IO.FileMode.Create))
    {
        System.IO.BinaryWriter writer = new System.IO.BinaryWriter(stream);
        writer.Write(decompressedData);
    }
return 0;
}
}

```

## 12.7 ManipulateFile.cs

```

/*=====
Program: GDCM (Grassroots DICOM). A DICOM library

Copyright (c) 2006-2011 Mathieu Malaterre
All rights reserved.
See Copyright.txt or http://gdcm.sourceforge.net/Copyright.html for details.

This software is distributed WITHOUT ANY WARRANTY; without even
the implied warranty of MERCHANTABILITY or FITNESS FOR A PARTICULAR
PURPOSE. See the above copyright notice for more information.

=====*/
/*
 * Usage:
 * $ export LD_LIBRARY_PATH=$HOME/Projects/gdcm/debug-gcc/bin
 * $ mono bin/ManipulateFile.exe gdcmData/012345.002.050.dcm out.dcm
 */
using System;
using gdcm;
public class ManipulateFile
{
    public static int Main(string[] args)
    {
        string file1 = args[0];
        string file2 = args[1];
        Reader reader = new Reader();
        reader.SetFileName( file1 );
        bool ret = reader.Read();
        if( !ret )
        {
            return 1;
        }
        Anonymizer ano = new Anonymizer();
        ano.SetFile( reader.GetFile() );
        ano.RemovePrivateTags();
        ano.RemoveGroupLength();
        Tag t = new Tag(0x10,0x10);
        ano.Replace( t, "GDCM^Csharp^Test^Hello^World" );
        UIDGenerator g = new UIDGenerator();
        ano.Replace( new Tag(0x0008,0x0018), g.Generate() );
        ano.Replace( new Tag(0x0020,0x000d), g.Generate() );
        ano.Replace( new Tag(0x0020,0x000e), g.Generate() );
        ano.Replace( new Tag(0x0020,0x0052), g.Generate() );
        Writer writer = new Writer();
        writer.SetFileName( file2 );
        writer.SetFile( ano.GetFile() );
        ret = writer.Write();
        if( !ret )
        {
            return 1;
        }
        return 0;
    }
}

```



## 12.8 ClinicalTrialIdentificationWorkflow.cs

This is a C# example on how to use Anonymizer

```

/*=====
Program: GDCM (Grassroots DICOM). A DICOM library

Copyright (c) 2006-2011 Mathieu Malaterre
All rights reserved.
See Copyright.txt or http://gdcms.sourceforge.net/Copyright.html for details.

This software is distributed WITHOUT ANY WARRANTY; without even
the implied warranty of MERCHANTABILITY or FITNESS FOR A PARTICULAR
PURPOSE. See the above copyright notice for more information.

=====*/
/*
 * Typical usage on UNIX:
 * $ export LD_LIBRARY_PATH=$HOME/Projects/gdcm/debug-gcc/bin
 * $ mono bin/ClinicalTrialIdentificationWorkflow.exe input_dir output_dir
 */
using System;
using gdcm;
public class MyWatcher : SimpleSubjectWatcher
{
    public MyWatcher(Subject s):base(s,"Override String"){
    protected override void StartFilter() {
        System.Console.WriteLine( "This is my start" );
    }
    protected override void EndFilter(){
        System.Console.WriteLine( "This is my end" );
    }
    protected override void ShowProgress(Subject caller, Event evt){
        ProgressEvent pe = ProgressEvent.Cast(evt);
        System.Console.WriteLine( "This is my progress: " + pe.GetProgress() );
    }
    protected override void ShowIteration(){
        System.Console.WriteLine( "This is my iteration" );
    }
    protected override void ShowAnonymization(Subject caller, Event evt){
/*
 * A couple of explanation are necessary here to understand how SWIG work
 * http://www.swig.org/Doc1.3/Java.html#adding_downcasts
 *
 * System.Console.WriteLine( "This is my Anonymization. Type: " + evt.GetEventName() );
 * System.Type type = evt.GetType();
 * System.Console.WriteLine( "This is my Anonymization. System.Type: " + type.ToString() );
 * System.Console.WriteLine( "This is my Anonymization. CheckEvent: " + ae.CheckEvent( evt ) );
 * System.Console.WriteLine( "This is my Anonymization. Processing Tag #" + ae.GetTag().toString() );
 */
        AnonymizeEvent ae = AnonymizeEvent.Cast(evt);
        if( ae != null )
        {
            Tag t = ae.GetTag();
            System.Console.WriteLine( "This is my Anonymization. Processing Tag #" + t.toString() );
        }
        else
        {
            System.Console.WriteLine( "This is my Anonymization. Unhandled Event type: " + evt.GetEventName() );
        }
    }
    protected override void ShowAbort(){
        System.Console.WriteLine( "This is my abort" );
    }
}
public class ClinicalTrialIdentificationWorkflow
{
    public static bool ProcessOneFile( gdcm.Anonymizer ano , string filename, string outfilename )
    {
        Reader reader = new Reader();
        reader.SetFileName( filename );
        bool ret = reader.Read();
        if( !ret )
        {
            return false;
        }
        // Pass in the file:
        ano.SetFile( reader.GetFile() );
        // First step, let's protect all Patient information as per

```

```

// PS 3.15 / E.1 / Basic Application Level Confidentiality Profile
if( !ano.BasicApplicationLevelConfidentialityProfile() )
{
    return false;
}
// Now let's pass in all Clinical Trial fields
// PS 3.3 - 2008 / C.7.1.3 Clinical Trial Subject Module
/*
Clinical Trial Sponsor Name (0012,0010) 1 The name of the clinical trial sponsor. See C.7.1.3.1.1.
Clinical Trial Protocol ID (0012,0020) 1 Identifier for the noted protocol. See C.7.1.3.1.2.
Clinical Trial Protocol Name (0012,0021) 2 The name of the clinical trial protocol. See C.7.1.3.1.3.
Clinical Trial Site ID (0012,0030) 2 The identifier of the site responsible for submitting clinical trial
    data. See C.7.1.3.1.4.
Clinical Trial Site Name (0012,0031) 2 Name of the site responsible for submitting clinical trial data. See
    C.7.1.3.1.5
Clinical Trial Subject ID (0012,0040) 1C The assigned identifier for the clinical trial subject. See
    C.7.1.3.1.6. Shall be present if Clinical Trial Subject Reading ID (0012,0042) is absent. May be present
    otherwise.
Clinical Trial Subject Reading ID (0012,0042) 1C Identifies the subject for blinded evaluations. Shall be
    present if Clinical Trial Subject ID (0012,0040) is absent. May be present otherwise. See C.7.1.3.1.7.
*/
ano.Replace( new gdcM.Tag(0x0012,0x0010), "MySponsorName");
ano.Replace( new gdcM.Tag(0x0012,0x0020), "MyProtocolID");
ano.Replace( new gdcM.Tag(0x0012,0x0021), "MyProtocolName");
ano.Replace( new gdcM.Tag(0x0012,0x0030), "MySiteId");
ano.Replace( new gdcM.Tag(0x0012,0x0031), "MySiteName");
ano.Replace( new gdcM.Tag(0x0012,0x0040), "MySponsorId");
ano.Replace( new gdcM.Tag(0x0012,0x0050), "MyTPId");
ano.Replace( new gdcM.Tag(0x0012,0x0051), "MyTPDescription");
// The following two are not required as they are guaranteed to be filled in by the
// Basic Application Level Confidentiality Profile. Only override if you understand what
// you are doing
//ano.Replace( new gdcM.Tag(0x0012,0x0062), "YES");
//ano.Replace( new gdcM.Tag(0x0012,0x0063), "My Super Duper Anonymization Overload");
// We might be generating a subdirectory. Let's make sure the subdir exist:
gdcM.FileName fn = new gdcM.FileName( outfileName );
string subdir = fn.GetPath();
if( !gdcM.PosixEmulation.MakeDirectory( subdir ) )
{
    return false;
}
gdcM.FileMetaInformation fmi = ano.GetFile().GetHeader();
// The following three lines make sure to regenerate any value:
fmi.Remove( new gdcM.Tag(0x0002,0x0012) );
fmi.Remove( new gdcM.Tag(0x0002,0x0013) );
fmi.Remove( new gdcM.Tag(0x0002,0x0016) );
Writer writer = new Writer();
writer.SetFileName( outfileName );
writer.SetFile( ano.GetFile() );
ret = writer.Write();
if( !ret )
{
    return false;
}
return true;
}
public static int Main(string[] args)
{
    gdcM.FileMetaInformation.SetSourceApplicationEntityTitle( "My ClinicalTrial App" );
    // http://www.oid-info.com/get/1.3.6.1.4.17434
    string THERALYS_ORG_ROOT = "1.3.6.1.4.17434";
    gdcM.UIDGenerator.SetRoot( THERALYS_ORG_ROOT );
    System.Console.WriteLine( "Root dir is now: " + gdcM.UIDGenerator.GetRoot() );
    gdcM.Global global = gdcM.Global.GetInstance();
    if( !global.LoadResourcesFiles() )
    {
        System.Console.WriteLine( "Could not LoadResourcesFiles" );
        return 1;
    }
    if( args.Length != 2 )
    {
        System.Console.WriteLine( "Usage:" );
        System.Console.WriteLine( "ClinicalTrialIdentificationWorkflow input_dir output_dir" );
        return 1;
    }
    string dir1 = args[0];
    string dir2 = args[1];
    // Check input is valid:
    if( !gdcM.PosixEmulation.FileIsDirectory(dir1) )
    {
        System.Console.WriteLine( "Input directory: " + dir1 + " does not exist. Sorry" );
    }
}

```

```

        return 1;
    }
}
if( !gdcm.PosixEmulation.FileIsDirectory(dir2) )
{
    System.Console.WriteLine( "Output directory: " + dir2 + " does not exist. Sorry" );
    return 1;
}
// Recursively search all file within this toplevel directory:
Directory d = new Directory();
uint nfiles = d.Load( dir1, true );
if(nfiles == 0) return 1;
// Let's use the pre-shipped certificate of GDCM.
string certpath = gdcm.Filename.Join(gdcm.Testing.GetSourceDirectory(),
    "/Testing/Source/Data/certificate.pem" );
gdcm.CryptoFactory fact = gdcm.CryptoFactory.GetFactoryInstance();
gdcm.CryptographicMessageSyntax cms = fact.CreateCMSProvider();
if( !cms.ParseCertificateFile( certpath ) )
{
    System.Console.WriteLine( "PEM Certificate : " + certpath + " could not be read. Sorry" );
    return 1;
}
//Anonymizer ano = new Anonymizer();
// A reference to an actual C++ instance is required here:
SmartPtrAno sano = Anonymizer.New();
Anonymizer ano = sano.__ref__();
//SimpleSubjectWatcher watcher = new SimpleSubjectWatcher(ano, "Anonymizer");
MyWatcher watcher = new MyWatcher(ano);
// Explicitly specify the Cryptographic Message Syntax to use:
ano.SetCryptographicMessageSyntax( cms );
// Process all filenames:
FilenamesType filenames = d.GetFilesNames();
for( uint i = 0; i < nfiles; ++i )
{
    string filename = filenames[ (int)i ];
    string outfilename = filename.Replace( dir1, dir2 );
    System.Console.WriteLine( "Filename: " + filename );
    System.Console.WriteLine( "Out Filename: " + outfilename );
    if( !ProcessOneFile( ano , filename, outfilename ) )
    {
        System.Console.WriteLine( "Could not process filename: " + filename );
        return 1;
    }
}
return 0;
}
}
}

```

## 12.9 GenerateDICOMDIR.cs

This is a C# example on how to use DICOMDIRGenerator

```

/*-----
Program: GDCM (Grassroots DICOM). A DICOM library

Copyright (c) 2006-2011 Mathieu Malaterre
All rights reserved.
See Copyright.txt or http://gdcm.sourceforge.net/Copyright.html for details.

This software is distributed WITHOUT ANY WARRANTY; without even
the implied warranty of MERCHANTABILITY or FITNESS FOR A PARTICULAR
PURPOSE. See the above copyright notice for more information.

-----*/
/*
 * Simple C# example to show how to use DICOMDIRGenerator
 *
 * Usage:
 * $ export LD_LIBRARY_PATH=$HOME/Projects/gdcm/debug-gcc/bin
 * $ mono bin/GenerateDICOMDIR.exe path output_filename
 */
using System;
using gdcm;
public class GenerateDICOMDIR
{
    public static int Main(string[] args)

```

```

{
string directory = args[0];
string outfilename = args[1];
Directory d = new Directory();
uint nfiles = d.Load( directory, true );
if(nfiles == 0) return 1;
//System.Console.WriteLine( "Files:\n" + d.toString() );
// Implement fast path ?
// Scanner s = new Scanner();
string descriptor = "My_Descriptor";
FileNamesType filenames = d.GetFilesNames();
gdcm.DICOMDIRGenerator gen = new DICOMDIRGenerator();
gen.SetFilenames( filenames );
gen.SetDescriptor( descriptor );
if( !gen.Generate() )
{
return 1;
}
gdcm.FileMetaInformation.SetSourceApplicationEntityTitle( "GenerateDICOMDIR" );
gdcm.Writer writer = new Writer();
writer.SetFile( gen.GetFile() );
writer.SetFileName( outfilename );
if( !writer.Write() )
{
return 1;
}
return 0;
}
}

```

## 12.10 GenFakelImage.cxx

```

/*=====
Program: GDCM (Grassroots DICOM). A DICOM library

Copyright (c) 2006-2011 Mathieu Malaterre
All rights reserved.
See Copyright.txt or http://gdcm.sourceforge.net/Copyright.html for details.

This software is distributed WITHOUT ANY WARRANTY; without even
the implied warranty of MERCHANTABILITY or FITNESS FOR A PARTICULAR
PURPOSE. See the above copyright notice for more information.

=====*/
#include "gdcmImage.h"
#include "gdcmImageWriter.h"
#include "gdcmFileDerivation.h"
#include "gdcmUIDGenerator.h"
//#include "gdcmImageChangePhotometricInterpretation.h"
/*
 * This example shows two things:
 * 1. How to create an image ex-nihilo
 * 2. How to use the gdcm.FileDerivation filter. This filter is meant to create "DERIVED" image
 * object. FileDerivation has a simple API where you can reference *all* the input image that have been
 * used to generate the image. The API also allows user to specify the purpose of reference (see CID 7202,
 * PS 3.16 - 2008), and the image derivation type (CID 7203, PS 3.16 - 2008).
 */
int main(int, char *[])
{
// Step 1: Fake Image
gdcm::SmartPointer<gdcm::Image> im = new gdcm::Image;
char * buffer = new char[ 256 * 256 * 3];
char * p = buffer;
int b = 128;
//int ybr[3];
int ybr2[3];
//int rgb[3];
for(int r = 0; r < 256; ++r)
for(int g = 0; g < 256; ++g)
for(int b = 0; b < 256; ++b)
{
//rgb[0] = r;
//rgb[1] = g;
//rgb[1] = 128;
//rgb[2] = b;
//ybr[0] = r;

```

```

        //ybr[1] = g;
        //ybr[1] = 128;
        //ybr[2] = b;
        ybr2[0] = r;
        ybr2[1] = g;
        ybr2[1] = 128;
        ybr2[2] = b;
        //gdcm::ImageChangePhotometricInterpretation::YBR2RGB(rgb, ybr);
        //gdcm::ImageChangePhotometricInterpretation::RGB2YBR(ybr2, rgb);
        *p++ = (char)ybr2[0];
        *p++ = (char)ybr2[1];
        *p++ = (char)ybr2[2];
    }
    im->SetNumberOfDimensions( 2 );
    im->SetDimension(0, 256 );
    im->SetDimension(1, 256 );
    im->GetPixelFormat().SetSamplesPerPixel(3);
    //im->SetPhotometricInterpretation( gdcm::PhotometricInterpretation::RGB );
    im->SetPhotometricInterpretation( gdcm::PhotometricInterpretation::YBR_FULL );
    unsigned long l = im->GetBufferLength();
    if( l != 256 * 256 * 3 )
    {
        return 1;
    }
    gdcm::DataElement pixeldata( gdcm::Tag(0x7fe0,0x0010) );
    pixeldata.SetByteValue( buffer, (uint32_t)l );
    delete[] buffer;
    im->SetDataElement( pixeldata );
    gdcm::UIDGenerator uid; // helper for uid generation
    gdcm::SmartPointer<gdcm::File> file = new gdcm::File; // empty file
    // Step 2: DERIVED object
    gdcm::FileDerivation fd;
    // For the purpose of this exercise we will pretend that this image is referencing
    // two source image (we need to generate fake UID for that).
    const char ReferencedSOPClassUID[] = "1.2.840.10008.5.1.4.1.1.7"; // Secondary Capture
    fd.AddReference( ReferencedSOPClassUID, uid.Generate() );
    fd.AddReference( ReferencedSOPClassUID, uid.Generate() );
    // Again for the purpose of the exercise we will pretend that the image is a
    // multiplanar reformat (MPR):
    // CID 7202 Source Image Purposes of Reference
    // {"DCM",121322,"Source image for image processing operation"},
    fd.SetPurposeOfReferenceCodeSequenceCodeValue( 121322 );
    // CID 7203 Image Derivation
    // {"DCM",113072,"Multiplanar reformatting" },
    fd.SetDerivationCodeSequenceCodeValue( 113072 );
    fd.SetFile( *file );
    // If all Code Value are ok the filter will execute properly
    if( !fd.Derive() )
    {
        std::cerr << "Sorry could not derive using input info" << std::endl;
        return 1;
    }
    // We pass both :
    // 1. the fake generated image
    // 2. the 'DERIVED' dataset object
    // to the writer.
    gdcm::ImageWriter w;
    w.SetImage( *im );
    w.SetFile( fd.GetFile() );
    // Set the filename:
    w.SetFileName( "ybr2.dcm" );
    if( !w.Write() )
    {
        return 1;
    }
    return 0;
}

```

## 12.11 ReformatFile.cs

This is a C++ example on how to use FileDerivation

/\*=====

Program: GDCM (Grassroots DICOM). A DICOM library

Copyright (c) 2006-2011 Mathieu Malaterre  
 All rights reserved.  
 See Copyright.txt or <http://gdcm.sourceforge.net/Copyright.html> for details.

This software is distributed WITHOUT ANY WARRANTY; without even  
 the implied warranty of MERCHANTABILITY or FITNESS FOR A PARTICULAR  
 PURPOSE. See the above copyright notice for more information.

```

=====*/
/*
 * Simple C# example
 *
 * Usage:
 * $ export LD_LIBRARY_PATH=$HOME/Projects/gdcm/debug-gcc/bin
 * $ mono bin/ReformatFile.exe input.dcm output.dcm
 */
using System;
using gdcm;
public class ReformatFile
{
    public static int Main(string[] args)
    {
        gdcm.FileMetaInformation.SetSourceApplicationEntityTitle( "My Reformat App" );
        // http://www.oid-info.com/get/1.3.6.1.4.17434
        string THERALYS_ORG_ROOT = "1.3.6.1.4.17434";
        gdcm.UIDGenerator.SetRoot( THERALYS_ORG_ROOT );
        System.Console.WriteLine( "Root dir is now: " + gdcm.UIDGenerator.GetRoot() );
        string filename = args[0];
        string outfilename = args[1];
        Reader reader = new Reader();
        reader.SetFileName( filename );
        if( !reader.Read() )
        {
            System.Console.WriteLine( "Could not read: " + filename );
            return 1;
        }
        UIDGenerator uid = new UIDGenerator(); // helper for uid generation
        FileDerivation fd = new FileDerivation();
        // For the puse of this exercise we will pretend that this image is referencing
        // two source image (we need to generate fake UID for that).
        string ReferencedSOPClassUID = "1.2.840.10008.5.1.4.1.1.7"; // Secondary Capture
        fd.AddReference( ReferencedSOPClassUID, uid.Generate() );
        fd.AddReference( ReferencedSOPClassUID, uid.Generate() );
        // Again for the purpose of the exercise we will pretend that the image is a
        // multiplanar reformat (MPR):
        // CID 7202 Source Image Purposes of Reference
        // { "DCM",121322,"Source image for image processing operation"},
        fd.SetPurposeOfReferenceCodeSequenceCodeValue( 121322 );
        // CID 7203 Image Derivation
        // { "DCM",113072,"Multiplanar reformatting" },
        fd.SetDerivationCodeSequenceCodeValue( 113072 );
        fd.SetFile( reader.GetFile() );
        // If all Code Value are ok the filter will execute properly
        if( !fd.Derive() )
        {
            return 1;
        }
        gdcm.FileMetaInformation fmi = reader.GetFile().GetHeader();
        // The following three lines make sure to regenerate any value:
        fmi.Remove( new gdcm.Tag(0x0002,0x0012) );
        fmi.Remove( new gdcm.Tag(0x0002,0x0013) );
        fmi.Remove( new gdcm.Tag(0x0002,0x0016) );
        Writer writer = new Writer();
        writer.SetFileName( outfilename );
        writer.SetFile( fd.GetFile() );
        if( !writer.Write() )
        {
            System.Console.WriteLine( "Could not write: " + outfilename );
            return 1;
        }
        return 0;
    }
}

```

## 12.12 DecompressImage.cs

This is a C# example on how to use Image

```

/*=====
Program: GDCM (Grassroots DICOM). A DICOM library

Copyright (c) 2006-2011 Mathieu Malaterre
All rights reserved.
See Copyright.txt or http://gdcm.sourceforge.net/Copyright.html for details.

This software is distributed WITHOUT ANY WARRANTY; without even
the implied warranty of MERCHANTABILITY or FITNESS FOR A PARTICULAR
PURPOSE. See the above copyright notice for more information.

=====*/
/*
 * Usage:
 * $ export LD_LIBRARY_PATH=$HOME/Projects/gdcm/debug-gcc/bin
 * $ mono bin/DecompressImage.exe gdcmData/012345.002.050.dcm decompress.dcm
 */
using System;
using gdcm;
public class DecompressImage
{
    public static int Main(string[] args)
    {
        string file1 = args[0];
        string file2 = args[1];
        ImageReader reader = new ImageReader();
        reader.SetFileName( file1 );
        bool ret = reader.Read();
        if( !ret )
        {
            return 1;
        }
        // check that one can access a Fragment from C#:
        var de = reader.GetFile().GetDataSet().GetDataElement( new Tag(0x7fe0, 0x0010) );
        var sq = de.GetSequenceOfFragments();
        sq.GetFragment(0);
        Image image = new Image();
        Image ir = reader.GetImage();
        image.SetNumberOfDimensions( ir.GetNumberOfDimensions() );
        //Just for fun:
        //int dircos = ir.GetDirectionCosines();
        //t = gdcm.Orientation.GetType(dircos);
        //int l = gdcm.Orientation.GetLabel(t);
        //System.Console.WriteLine( "Orientation label:" + l );
        // Set the dimensions,
        // 1. either one at a time
        //image.SetDimension(0, ir.GetDimension(0) );
        //image.SetDimension(1, ir.GetDimension(1) );
        // 2. the array at once
        uint[] dims = {0, 0};
        // Just for fun let's invert the dimensions:
        dims[0] = ir.GetDimension(1);
        dims[1] = ir.GetDimension(0);
        ir.SetDimensions( dims );
        PixelFormat pixeltype = ir.GetPixelFormat();
        image.SetPixelFormat( pixeltype );
        PhotometricInterpretation pi = ir.GetPhotometricInterpretation();
        image.SetPhotometricInterpretation( pi );
        DataElement pixeldata = new DataElement( new Tag(0x7fe0,0x0010) );
        byte[] str1 = new byte[ ir.GetBufferLength()];
        ir.GetBuffer( str1 );
        //System.Console.WriteLine( ir.GetBufferLength() );
        pixeldata.SetByteValue( str1, new VL( (uint)str1.Length ) );
        //image.SetDataElement( pixeldata );
        ir.SetDataElement( pixeldata );
        ImageWriter writer = new ImageWriter();
        writer.SetFileName( file2 );
        writer.SetFile( reader.GetFile() );
        writer.SetImage( ir );
        ret = writer.Write();
        if( !ret )
        {
            return 1;
        }
        return 0;
    }
}

```

## 12.13 StandardizeFiles.cs

This is a C++ example on how to use ImageChangeTransferSyntax

```

/*=====
Program: GDCM (Grassroots DICOM). A DICOM library

Copyright (c) 2006-2011 Mathieu Malaterre
All rights reserved.
See Copyright.txt or http://gdcm.sourceforge.net/Copyright.html for details.

This software is distributed WITHOUT ANY WARRANTY; without even
the implied warranty of MERCHANTABILITY or FITNESS FOR A PARTICULAR
PURPOSE. See the above copyright notice for more information.

=====*/
/*
 * Simple C# example to show how one would 'Standardize' a DICOM File-Set
 *
 * Usage:
 * $ export LD_LIBRARY_PATH=$HOME/Projects/gdcm/debug-gcc/bin
 * $ mono bin/StandardizeFiles.exe input_path output_path
 */
using System;
using gdcm;
public class StandardizeFiles
{
    public static bool ProcessOneFile( string filename, string outfilename )
    {
        PixmapReader reader = new PixmapReader();
        reader.SetFileName( filename );
        if( !reader.Read() )
        {
            System.Console.WriteLine( "Could not read: " + filename );
            return false;
        }
        ImageChangeTransferSyntax change = new ImageChangeTransferSyntax();
        change.SetForce( false ); // do we really want to recompress when input is already compressed in same alg ?
        change.SetCompressIconImage( false ); // Keep it simple
        change.SetTransferSyntax( new TransferSyntax( TransferSyntax.TSType.JPEG2000Lossless ) );
        change.SetInput( reader.GetPixmap() );
        if( !change.Change() )
        {
            System.Console.WriteLine( "Could not change: " + filename );
            return false;
        }
        gdcm.FileMetaInformation fmi = reader.GetFile().GetHeader();
        // The following three lines make sure to regenerate any value:
        fmi.Remove( new gdcm.Tag(0x0002,0x0012) );
        fmi.Remove( new gdcm.Tag(0x0002,0x0013) );
        fmi.Remove( new gdcm.Tag(0x0002,0x0016) );
        PixmapWriter writer = new PixmapWriter();
        writer.SetFileName( outfilename );
        writer.SetFile( reader.GetFile() );
        gdcm.Pixmap pixout = ((PixmapToPixmapFilter)change).GetOutput();
        writer.SetPixmap( pixout );
        if( !writer.Write() )
        {
            System.Console.WriteLine( "Could not write: " + outfilename );
            return false;
        }
        return true;
    }
    public static int Main(string[] args)
    {
        gdcm.FileMetaInformation.SetSourceApplicationEntityTitle( "My Standardize App" );
        // http://www.oid-info.com/get/1.3.6.1.4.17434
        string THERALYS_ORG_ROOT = "1.3.6.1.4.17434";
        gdcm.UIDGenerator.SetRoot( THERALYS_ORG_ROOT );
        System.Console.WriteLine( "Root dir is now: " + gdcm.UIDGenerator.GetRoot() );
        string dir1 = args[0];
        string dir2 = args[1];
        // Check input is valid:
        if( !gdcm.PosixEmulation.FileIsDirectory( dir1 ) )
        {
            System.Console.WriteLine( "Input directory: " + dir1 + " does not exist. Sorry" );
            return 1;
        }
        if( !gdcm.PosixEmulation.FileIsDirectory( dir2 ) )

```



```

    {
        System.Console.WriteLine( "Output directory: " + dir2 + " does not exist. Sorry" );
        return 1;
    }
    Directory d = new Directory();
    uint nfiles = d.Load( dir1, true );
    if(nfiles == 0) return 1;
    // Process all filenames:
    FilenamesType filenames = d.GetFilesNames();
    for( uint i = 0; i < nfiles; ++i )
    {
        string filename = filenames[ (int)i ];
        string outfilename = filename.Replace( dir1, dir2 );
        System.Console.WriteLine( "Filename: " + filename );
        System.Console.WriteLine( "Out Filename: " + outfilename );
        if( !ProcessOneFile( filename, outfilename ) )
        {
            System.Console.WriteLine( "Could not process filename: " + filename );
            //return 1;
        }
    }
    return 0;
}
}

```

## 12.14 ScanDirectory.cs

This is a C# example on how to use Scanner

```

/*=====
Program: GDCM (Grassroots DICOM). A DICOM library

Copyright (c) 2006-2011 Mathieu Malaterre
All rights reserved.
See Copyright.txt or http://gdcm.sourceforge.net/Copyright.html for details.

This software is distributed WITHOUT ANY WARRANTY; without even
the implied warranty of MERCHANTABILITY or FITNESS FOR A PARTICULAR
PURPOSE. See the above copyright notice for more information.

=====*/
/*
 * Usage:
 * $ bin/ScanDirectory.exe /path/to/gdcmData/
 */
using System;
using gdcm;
// We will print each filename being processed
public class MyWatcher : SimpleSubjectWatcher
{
    public MyWatcher(Subject s):base(s,"Override String"){
    protected override void ShowFileName(Subject caller, Event evt){
        FileNameEvent fne = FileNameEvent.Cast(evt);
        if( fne != null )
        {
            string fn = fne.GetFileName();
            System.Console.WriteLine( "This is my Scanner. Processing FileName: " + fn );
        }
        else
        {
            System.Console.WriteLine( "This is my Anonymization. Unhandled Event type: " + evt.GetEventName() );
        }
    }
}
public class ScanDirectory
{
    public static int Main(string[] args)
    {
        string directory = args[0];
        Tag t = new Tag(0x8,0x80);
        Directory d = new Directory();
        uint nfiles = d.Load( directory );
        if(nfiles == 0) return 1;
        //System.Console.WriteLine( "Files:\n" + d.toString() );
        // Use a StrictScanner, need to use a reference to pass the C++ pointer to

```

```

// MyWatcher implementation
SmartPtrStrictScan sscan = StrictScanner.New();
StrictScanner s = sscan.__ref__();
MyWatcher watcher = new MyWatcher(s);
s.AddTag( t );
bool b = s.Scan( d.GetFileNames() );
if(!b) return 1;
for(int i = 0; i < (int)nfiles; ++i)
{
    if( !s.IsKey( d.GetFileNames()[i] ) )
    {
        System.Console.WriteLine( "File is not DICOM or could not be read: " + d.GetFileNames()[i] );
    }
}
System.Console.WriteLine( "Scan:\n" + s.toString() );
System.Console.WriteLine( "success" );
return 0;
}
}

```

## 12.15 BasicAnonymizer.cs

```

/*=====
Program: GDCM (Grassroots DICOM). A DICOM library

Copyright (c) 2006-2011 Mathieu Malaterre
All rights reserved.
See Copyright.txt or http://gdcms.sourceforge.net/Copyright.html for details.

This software is distributed WITHOUT ANY WARRANTY; without even
the implied warranty of MERCHANTABILITY or FITNESS FOR A PARTICULAR
PURPOSE. See the above copyright notice for more information.

=====*/
/*
 * Usage:
 * $ export LD_LIBRARY_PATH=$HOME/Projects/gdcm/debug-gcc/bin
 * $ mono bin/BasicAnonymizer.exe gdcmData/012345.002.050.dcm out.dcm
 */
using System;
using gdcm;
public class MyWatcher : SimpleSubjectWatcher
{
    public MyWatcher(Subject s):base(s,"Override String"){
        protected override void StartFilter() {
            System.Console.WriteLine( "This is my start" );
        }
        protected override void EndFilter(){
            System.Console.WriteLine( "This is my end" );
        }
        protected override void ShowProgress(Subject caller, Event evt){
            ProgressEvent pe = ProgressEvent.Cast(evt);
            System.Console.WriteLine( "This is my progress: " + pe.GetProgress() );
        }
        protected override void ShowIteration(){
            System.Console.WriteLine( "This is my iteration" );
        }
        protected override void ShowAnonymization(Subject caller, Event evt){
/*
 * A couple of explanation are necessary here to understand how SWIG work
 * http://www.swig.org/Doc1.3/Java.html#adding_downcasts
 *
 * System.Console.WriteLine( "This is my Anonymization. Type: " + evt.GetEventName() );
 * System.Type type = evt.GetType();
 * System.Console.WriteLine( "This is my Anonymization. System.Type: " + type.ToString() );
 * System.Console.WriteLine( "This is my Anonymization. CheckEvent: " + ae.CheckEvent( evt ) );
 * System.Console.WriteLine( "This is my Anonymization. Processing Tag #" + ae.GetTag().toString() );
 */
            AnonymizeEvent ae = AnonymizeEvent.Cast(evt);
            if( ae != null )
            {
                Tag t = ae.GetTag();
                System.Console.WriteLine( "This is my Anonymization. Processing Tag #" + t.toString() );
            }
            else
            {

```

```

        System.Console.WriteLine( "This is my Anonymization. Unhandled Event type: " + evt.GetEventName() );
    }
}
protected override void ShowAbort(){
    System.Console.WriteLine( "This is my abort" );
}
}
public class BasicAnonymizer
{
    public static int Main(string[] args)
    {
        {
            gdcM.Global global = gdcM.Global.GetInstance();
            if( !global.LoadResourcesFiles() )
            {
                System.Console.WriteLine( "Could not LoadResourcesFiles" );
                return 1;
            }
            string file1 = args[0];
            string file2 = args[1];
            Reader reader = new Reader();
            reader.SetFileName( file1 );
            bool ret = reader.Read();
            if( !ret )
            {
                return 1;
            }
            string certpath = gdcM.FileName.Join(gdcM.Testing.GetSourceDirectory(),
                "/Testing/Source/Data/certificate.pem" );
            gdcM.CryptoFactory fact = gdcM.CryptoFactory.GetFactoryInstance();
            gdcM.CryptographicMessageSyntax cms = fact.CreateCMSProvider();
            if( !cms.ParseCertificateFile( certpath ) )
            {
                return 1;
            }
            //Anonymizer ano = new Anonymizer();
            SmartPtrAno sano = Anonymizer.New();
            Anonymizer ano = sano.__ref__();
            //SimpleSubjectWatcher watcher = new SimpleSubjectWatcher(ano, "Anonymizer");
            MyWatcher watcher = new MyWatcher(ano);
            ano.SetFile( reader.GetFile() );
            ano.SetCryptographicMessageSyntax( cms );
            if( !ano.BasicApplicationLevelConfidentialityProfile() )
            {
                return 1;
            }
            Writer writer = new Writer();
            writer.SetFileName( file2 );
            writer.SetFile( ano.GetFile() );
            ret = writer.Write();
            if( !ret )
            {
                return 1;
            }
            return 0;
        }
    }
}

```

## 12.16 BasicImageAnonymizer.cs

```

/*=====
Program: GDCM (Grassroots DICOM). A DICOM library

Copyright (c) 2006-2011 Mathieu Malaterre
All rights reserved.
See Copyright.txt or http://gdcM.sourceforge.net/Copyright.html for details.

This software is distributed WITHOUT ANY WARRANTY; without even
the implied warranty of MERCHANTABILITY or FITNESS FOR A PARTICULAR
PURPOSE. See the above copyright notice for more information.

=====*/
/*
*/
using System;
using gdcM;
public class BasicImageAnonymizer

```

```

{
    public static int Main(string[] args)
    {
        string filename = args[0];
        // instantiate the reader:
        gdcm.ImageReader reader = new gdcm.ImageReader();
        reader.SetFileName( filename );
        if (!reader.Read()) return 1;
        Image ir = reader.GetImage();
        uint[] dims = {0, 0, 0};
        dims[0] = ir.GetDimension(0);
        dims[1] = ir.GetDimension(1);
        dims[2] = ir.GetDimension(2);
        System.Console.WriteLine( "Dim:" + dims[0] );
        System.Console.WriteLine( "Dim:" + dims[1] );
        System.Console.WriteLine( "Dim:" + dims[2] );
        // buffer to get the pixels
        byte[] buffer = new byte[ ir.GetBufferLength()];
        System.Console.WriteLine( "Dim:" + ir.GetBufferLength() );
        ir.GetBuffer( buffer );
        for (uint z = 0; z < dims[2]; z++)
        {
            for (uint y = 0; y < dims[1] / 2; y++) // only half Y
            {
                for (uint x = 0; x < dims[0] / 2; x++) // only half X
                {
                    buffer[ (z * dims[1] + y) * dims[0] + x ] = 0; // works when pixel type == UINT8
                }
            }
        }
        DataElement pixeldata = new DataElement( new Tag(0x7fe0,0x0010) );
        pixeldata.SetByteValue( buffer, new VL( (uint)buffer.Length ) );
        ir.SetDataElement( pixeldata );
        ir.SetTransferSyntax( new TransferSyntax( TransferSyntax.TSType.ExplicitVRLittleEndian ) );
        ImageChangeTransferSyntax change = new ImageChangeTransferSyntax();
        change.SetTransferSyntax( new TransferSyntax( TransferSyntax.TSType.JPEGLSLossless ) );
        change.SetInput( ir );
        if( !change.Change() )
        {
            System.Console.WriteLine( "Could not change: " + filename );
            return 1;
        }
        ImageWriter writer = new ImageWriter();
        writer.SetFileName( "out.dcm" );
        writer.SetFile( reader.GetFile() );
        writer.SetImage( change.GetOutput() );
        bool ret = writer.Write();
        if( !ret )
        {
            return 1;
        }
        return 0;
    }
}

```

## 12.17 CompressLossyJPEG.cs

```

/*=====
Program: GDCM (Grassroots DICOM). A DICOM library

Copyright (c) 2006-2011 Mathieu Malaterre
All rights reserved.
See Copyright.txt or http://gdcm.sourceforge.net/Copyright.html for details.

This software is distributed WITHOUT ANY WARRANTY; without even
the implied warranty of MERCHANTABILITY or FITNESS FOR A PARTICULAR
PURPOSE. See the above copyright notice for more information.

=====*/
/*
 * Usage:
 * $ export LD_LIBRARY_PATH=$HOME/Perso/gdcm/debug-gcc/bin
 * $ mono bin/CompressLossyJPEG.exe input.dcm output.dcm
 */
using System;
using gdcm;

```

```

public class CompressLossyJPEG
{
    public static int Main(string[] args)
    {
        if( args.Length < 2 )
        {
            System.Console.WriteLine( " input.dcm output.dcm" );
            return 1;
        }
        string filename = args[0];
        string outfilename = args[1];
        ImageReader reader = new ImageReader();
        reader.SetFileName( filename );
        if( !reader.Read() )
        {
            System.Console.WriteLine( "Could not read: " + filename );
            return 1;
        }
        // The output of gdcm::Reader is a gdcm::File
        File file = reader.GetFile();
        // the dataset is the the set of element we are interested in:
        DataSet ds = file.GetDataSet();
        Image image = reader.GetImage();
        //image.Print( cout );
        ImageChangeTransferSyntax change = new ImageChangeTransferSyntax();
        TransferSyntax targetts = new TransferSyntax( TransferSyntax.TSType.JPEGBaselineProcess1 );
        change.SetTransferSyntax( targetts );
        // Setup our JPEGCodec, warning it should be compatible with JPEGBaselineProcess1
        JPEGCodec jpegcodec = new JPEGCodec();
        if( !jpegcodec.CanCode( targetts ) )
        {
            System.Console.WriteLine( "Something went really wrong, JPEGCodec cannot handle JPEGBaselineProcess1" );
            return 1;
        }
        jpegcodec.SetLossless( false );
        jpegcodec.SetQuality( 50 ); // poor quality !
        change.SetUserCodec( jpegcodec ); // specify the codec to use to the ImageChangeTransferSyntax
        change.SetInput( image );
        bool b = change.Change();
        if( !b )
        {
            System.Console.WriteLine( "Could not change the Transfer Syntax" );
            return 1;
        }
        ImageWriter writer = new ImageWriter();
        writer.SetImage( (gdcm.Image)change.GetOutput() );
        writer.SetFile( reader.GetFile() );
        writer.SetFileName( outfilename );
        if( !writer.Write() )
        {
            System.Console.WriteLine( "Could not write: " + outfilename );
            return 1;
        }
        return 0;
    }
}

```

## 12.18 DecompressImageMultiframe.cs

```

/*=====
Program: GDCM (Grassroots DICOM). A DICOM library

Copyright (c) 2006-2011 Mathieu Malaterre
All rights reserved.
See Copyright.txt or http://gdcm.sourceforge.net/Copyright.html for details.

This software is distributed WITHOUT ANY WARRANTY; without even
the implied warranty of MERCHANTABILITY or FITNESS FOR A PARTICULAR
PURPOSE. See the above copyright notice for more information.

=====*/
/*
$ gdcminfo ~/Desktop/angiogram-06.dcm
MediaStorage is 1.2.840.10008.5.1.4.1.1.12.1 [X-Ray Angiographic Image Storage]
TransferSyntax is 1.2.840.10008.1.2.4.50 [JPEG Baseline (Process 1): Default Transfer Syntax for Lossy JPEG 8
Bit Image Compression]

```

```

NumberOfDimensions: 3
Dimensions: (512,512,355)
Origin: (0,0,0)
Spacing: (1,1,40)
DirectionCosines: (1,0,0,0,1,0)
Rescale Intercept/Slope: (0,1)
SamplesPerPixel      :1
BitsAllocated        :8
BitsStored           :8
HighBit              :7
PixelRepresentation:0
ScalarType found     :UINT8
PhotometricInterpretation: MONOCHROME2
PlanarConfiguration: 0
TransferSyntax: 1.2.840.10008.1.2.4.50
Orientation Label: AXIAL
*/
/*
 * Description:
 *
 * Assume we have a file angiogram-06.dcm as described above.
 * the following program will decompress directly from the extracted jpeg stream.
 *
 * First step extract the jpeg stream (but not the Basic Offset Table):
 *
 * $ gdcmmraw -i angiogram-06.dcm -o /tmp/output/chris --split-frags --pattern %d.jpg
 *
 * Check that indeed there are 355 files, while there are 356 fragments in the original DICOM file, since
 * gdcmmraw always skip the first fragment (Basic Offset Table).
 *
 * Now from those individual jpeg stream, recreate a fake gdcm.DataElement...
 *
 * Usage:
 *
 * $ export LD_LIBRARY_PATH=$HOME/Projects/gdcm/debug-gcc/bin
 * $ mono ./bin/DecompressImageMultiframe.exe /tmp/output
 */
using System;
using gdcm;
public class DecompressImageMultiframe
{
    public static int Main(string[] args)
    {
        string directory = args[0];
        gdcm.Directory dir = new gdcm.Directory();
        uint nfiles = dir.Load(directory);
        //System.Console.WriteLine(dir.toString());
        gdcm.FilenamesType filenames = dir.GetFilesNames();
        Image image = new Image();
        image.SetNumberOfDimensions( 3 ); // important for now
        DataElement pixeldata = new DataElement( new gdcm.Tag(0x7fe0,0x0010) );
        // Create a new SequenceOfFragments C++ object, store it as a SmartPointer :
        SmartPtrFrag sq = SequenceOfFragments.New();
        // Yeah, the file are not guarantee to be in order, please adapt...
        for(uint i = 0; i < nfiles; ++i)
        {
            System.Console.WriteLine( filenames[(int)i] );
            string file = filenames[(int)i];
            System.IO.FileStream infile =
                new System.IO.FileStream(file, System.IO.FileMode.Open, System.IO.FileAccess.Read);
            uint fsize = gdcm.PosixEmulation.FileSize(file);
            byte[] jstream = new byte[fsize];
            infile.Read(jstream, 0 , jstream.Length);
            Fragment frag = new Fragment();
            frag.SetByteValue( jstream, new gdcm.VL( (uint)jstream.Length) );
            sq.AddFragment( frag );
        }
        // Pass by reference:
        pixeldata.SetValue( sq.__ref__() );
        // insert:
        image.SetDataElement( pixeldata );
        // JPEG use YBR to achieve better compression ratio by default (not RGB)
        // FIXME hardcoded:
        PhotometricInterpretation pi = new PhotometricInterpretation( PhotometricInterpretation.PIType.MONOCHROME2
        );
        image.SetPhotometricInterpretation( pi );
        // FIXME hardcoded:
        PixelFormat pixeltype = new PixelFormat(1,8,8,7);
        image.SetPixelFormat( pixeltype );
        // FIXME hardcoded:
        image.SetTransferSyntax( new TransferSyntax( TransferSyntax.TSType.JPEGLosslessProcess14_1 ) );
    }
}

```

```

        image.SetDimension(0, 512);
        image.SetDimension(1, 512);
        image.SetDimension(2, 355);
        // Decompress !
        byte[] decompressedData = new byte[(int)image.GetBufferLength()];
        image.GetBuffer(decompressedData);
        // Write out the decompressed bytes
        System.Console.WriteLine(image.toString());
        using (System.IO.Stream stream =
            System.IO.File.Open(@"tmp/dd.raw",
                System.IO.FileMode.Create))
        {
            System.IO.BinaryWriter writer = new System.IO.BinaryWriter(stream);
            writer.Write(decompressedData);
        }
        return 0;
    }
}

```

## 12.19 DumpCSA.cs

```

/*=====
Program: GDCM (Grassroots DICOM). A DICOM library

Copyright (c) 2006-2011 Mathieu Malaterre
All rights reserved.
See Copyright.txt or http://gdcm.sourceforge.net/Copyright.html for details.

This software is distributed WITHOUT ANY WARRANTY; without even
the implied warranty of MERCHANTABILITY or FITNESS FOR A PARTICULAR
PURPOSE. See the above copyright notice for more information.

=====*/
/*
 * Usage:
 * $ bin/DumpCSA.exe input.dcm
 */
using System;
using gdcm;
public class DumpCSA
{
    public static int Main(string[] args)
    {
        string filename = args[0];
        gdcm.Reader reader = new gdcm.Reader();
        reader.SetFileName( filename );
        if (!reader.Read()) return 1;
        gdcm.File f = reader.GetFile();
        gdcm.DataSet ds = f.GetDataSet();
        string[] expectedSiemensTags = new string[] { "B_value", "AcquisitionMatrixText" };
        using (PrivateTag gtag = CSAHeader.GetCSAImageHeaderInfoTag())
        {
            if (ds.FindDataElement(gtag))
            {
                using (DataElement de = ds.GetDataElement(gtag))
                {
                    if (de != null && !de.IsEmpty())
                    {
                        using (CSAHeader csa = new CSAHeader())
                        {
                            if (csa.LoadFromDataElement(de))
                            {
                                foreach (string str in expectedSiemensTags)
                                {
                                    if (csa.FindCSAElementByName(str))
                                    {
                                        using (CSAElement elem = csa.GetCSAElementByName(str))
                                        {
                                            if (elem != null)
                                            {
                                                System.Console.WriteLine( elem.toString() );
                                            }
                                        }
                                    }
                                }
                            }
                        }
                    }
                }
            }
        }
    }
}

```

```

    }
    }
}
return 0;
}
}

```

## 12.20 ExtractEncapsulatedFile.cs

```

/*=====
Program: GDCM (Grassroots DICOM). A DICOM library

Copyright (c) 2006-2011 Mathieu Malaterre
All rights reserved.
See Copyright.txt or http://gdcm.sourceforge.net/Copyright.html for details.

This software is distributed WITHOUT ANY WARRANTY; without even
the implied warranty of MERCHANTABILITY or FITNESS FOR A PARTICULAR
PURPOSE. See the above copyright notice for more information.
=====*/
/*
 * This example shows how one from C# context can extract a binary blob
 * and write out as a file.
 * This example is meant for pdf encapsulated file, but can be adapted for other type
 * of binary blob.
 *
 * DICOM file is:
 * ...
 * (0042,0010) ST (no value available) # 0, 0 DocumentTitle
 * (0042,0011) OB 25\50\44\46\2d\31\2e\32\20\0d\25\e2\e3\cf\d3\20\0d\31\30\20\30\20... # 40718, 1
 * EncapsulatedDocument
 * (0042,0012) LO [application/pdf] # 16, 1 MIMETypeOfEncapsulatedDocument
 * ...
 *
 * Usage:
 * $ export LD_LIBRARY_PATH=$HOME/Projects/gdcm/debug-gcc/bin
 * $ mono bin/ExtractEncapsulatedFile.exe some_pdf_encapsulated.dcm
 */
using System;
using gdcm;
public class ExtractEncapsulatedFile
{
    public static int Main(string[] args)
    {
        string file = args[0];
        Reader reader = new Reader();
        reader.SetFileName( file );
        bool ret = reader.Read();
        if( !ret )
        {
            return 1;
        }
        File f = reader.GetFile();
        DataSet ds = f.GetDataSet();
        Tag tencapsulated_stream = new Tag(0x0042,0x0011); // Encapsulated Document
        if( !ds.FindElement( tencapsulated_stream ) )
        {
            return 1;
        }
        // else
        DataElement de = ds.GetDataElement( tencapsulated_stream );
        ByteValue bv = de.GetByteValue();
        uint len = bv.GetLength();
        byte[] encapsulated_stream = new byte[len];
        bv.GetBuffer( encapsulated_stream, len );
        // Write out the decompressed bytes
        //System.Console.WriteLine(image.toString());
        using (System.IO.Stream stream =
            System.IO.File.Open(@"tmp/dd.pdf",
                System.IO.FileMode.Create))
        {
            System.IO.BinaryWriter writer = new System.IO.BinaryWriter(stream);
            writer.Write( encapsulated_stream );
        }
    }
}

```



```

    }
    return 0;
}

```

## 12.21 ExtractImageRegion.cs

```

/*=====
Program: GDCM (Grassroots DICOM). A DICOM library

Copyright (c) 2006-2011 Mathieu Malaterre
All rights reserved.
See Copyright.txt or http://gdcm.sourceforge.net/Copyright.html for details.

This software is distributed WITHOUT ANY WARRANTY; without even
the implied warranty of MERCHANTABILITY or FITNESS FOR A PARTICULAR
PURPOSE. See the above copyright notice for more information.
=====*/
/*
 * This small code shows how to use the gdcm.ImageRegionReader API
 * In this example we are taking each frame by frame and dump them to
 * /tmp/frame.raw.
 *
 * Usage:
 * $ bin/ExtractImageRegion.exe input.dcm
 *
 * Example:
 * $ bin/ExtractImageRegion.exe gdcmData/012345.002.050.dcm
 * $ md5sum /tmp/frame.raw
 * d594a5e2fde12f32b6633ca859b4d4a6 /tmp/frame.raw
 * $ gdcmInfo --md5sum gdcmData/012345.002.050.dcm
 * [...]
 * md5sum: d594a5e2fde12f32b6633ca859b4d4a6
 */
using System;
using gdcm;
public class ExtractImageRegion
{
    public static int Main(string[] args)
    {
        string filename = args[0];
        uint file_size = gdcm.PosixEmulation.FileSize(filename);
        // instantiate the reader:
        gdcm.ImageRegionReader reader = new gdcm.ImageRegionReader();
        reader.SetFileName( filename );
        // pull DICOM info:
        if (!reader.ReadInformation()) return 1;
        // store current offset:
        uint cur_pos = reader.GetStreamCurrentPosition();
        uint remaining = file_size - cur_pos;
        Console.WriteLine("Remaining bytes to read (Pixel Data): " + remaining.ToString() );
        // Get file infos
        gdcm.File f = reader.GetFile();
        // get some info about image
        UIntArrayType dims = ImageHelper.GetDimensionsValue(f);
        PixelFormat pf = ImageHelper.GetPixelFormatValue( f);
        int pixelsize = pf.GetPixelFormatSize();
        PhotometricInterpretation pi = ImageHelper.GetPhotometricInterpretationValue(f);
        Console.WriteLine( pi.ToString() );
        // buffer to get the pixels
        byte[] buffer = new byte[ dims[0] * dims[1] * pixelsize ];
        // define a simple box region.
        BoxRegion box = new BoxRegion();
        for (uint z = 0; z < dims[2]; z++)
        {
            // Define that I want the image 0, full size (dimx x dimy pixels)
            // and do that for each z:
            box.SetDomain(0, dims[0] - 1, 0, dims[1] - 1, z, z);
            //System.Console.WriteLine( box.ToString() );
            reader.SetRegion( box );
            // reader will try to load the uncompressed image region into buffer.
            // the call returns an error when buffer.Length is too small. For instance
            // one can call:
            // uint buf_len = reader.ComputeBufferLength(); // take into account pixel size
            // to get the exact size of minimum buffer

```

```

    if (reader.ReadIntoBuffer(buffer, (uint)buffer.Length))
    {
        using (System.IO.Stream stream =
            System.IO.File.Open(@"tmp/frame.raw",
                System.IO.FileMode.Create))
        {
            System.IO.BinaryWriter writer = new System.IO.BinaryWriter(stream);
            writer.Write(buffer);
        }
    }
    else
    {
        throw new Exception("can't read pixels error");
    }
}
return 0;
}
}

```

## 12.22 ExtractImageRegionWithLUT.cs

```

/*=====
Program: GDCM (Grassroots DICOM). A DICOM library

Copyright (c) 2006-2011 Mathieu Malaterre
All rights reserved.
See Copyright.txt or http://gdcm.sourceforge.net/Copyright.html for details.

This software is distributed WITHOUT ANY WARRANTY; without even
the implied warranty of MERCHANTABILITY or FITNESS FOR A PARTICULAR
PURPOSE. See the above copyright notice for more information.

=====*/
/*
* This small code shows how to use the gdcm.ImageRegionReader API
* In this example we are taking each frame by frame and dump them to
* /tmp/frame.raw.
* Furthermore we are applying the LUT on this image.
* Special care should be taken in case the image is not PALETTE COLOR
*
* Usage:
* $ bin/ExtractImageRegionWithLUT.exe input.dcm
*
* Example:
* $ bin/ExtractImageRegionWithLUT.exe gdcmData/rle16lo0.dcm
* $ md5sum /tmp/frame_rgb.raw
* 73bf61325fdb6e2830244a2b7b0c4ae2 /tmp/frame_rgb.raw
* $ gdcming --depth 16 --spp 3 --size 600,430 /tmp/frame_rgb.raw rgb.dcm
* $ gdcviewer rgb.dcm
*/
using System;
using gdcm;
public class ExtractImageRegion
{
    public static int Main(string[] args)
    {
        string filename = args[0];
        // instantiate the reader:
        gdcm.ImageRegionReader reader = new gdcm.ImageRegionReader();
        reader.SetFileName( filename );
        // pull DICOM info:
        if (!reader.ReadInformation()) return 1;
        // Get file infos
        gdcm.File f = reader.GetFile();
        gdcm.LookupTable lut = reader.GetImage().GetLUT();
        // get some info about image
        UIntArrayType dims = ImageHelper.GetDimensionsValue(f);
        PixelFormat pf = ImageHelper.GetPixelFormatValue(f);
        int pixelsize = pf.GetPixelSize();
        // buffer to get the pixels
        byte[] buffer = new byte[ dims[0] * dims[1] * pixelsize ];
        // output buffer for the RGB decoded image:
        byte[] buffer2 = new byte[ dims[0] * dims[1] * pixelsize * 3 ];
        // define a simple box region.
        BoxRegion box = new BoxRegion();
        for (uint z = 0; z < dims[2]; z++)
    }
}

```

```

    {
        // Define that I want the image 0, full size (dimx x dimy pixels)
        // and do that for each z:
        box.SetDomain(0, dims[0] - 1, 0, dims[1] - 1, z, z);
        //System.Console.WriteLine( box.ToString() );
        reader.SetRegion( box );
        // reader will try to load the uncompressed image region into buffer.
        // the call returns an error when buffer.Length is too small. For instance
        // one can call:
        // uint buf_len = reader.ComputeBufferLength(); // take into account pixel size
        // to get the exact size of minimum buffer
        if (reader.ReadIntoBuffer(buffer, (uint)buffer.Length))
        {
            if( !lut.Decode( buffer2, (uint)buffer2.Length, buffer, (uint)buffer.Length ) )
            {
                throw new Exception("can't decode");
            }
            using (System.IO.Stream stream =
                System.IO.File.Open(@"tmp/frame_rgb.raw",
                    System.IO.FileMode.Create))
            {
                System.IO.BinaryWriter writer = new System.IO.BinaryWriter(stream);
                writer.Write(buffer2);
            }
        }
        else
        {
            throw new Exception("can't read pixels error");
        }
    }
    return 0;
}
}

```

## 12.23 ExtractOneFrame.cs

```

/*=====
Program: GDCM (Grassroots DICOM). A DICOM library

Copyright (c) 2006-2011 Mathieu Malaterre
All rights reserved.
See Copyright.txt or http://gdcm.sourceforge.net/Copyright.html for details.

This software is distributed WITHOUT ANY WARRANTY; without even
the implied warranty of MERCHANTABILITY or FITNESS FOR A PARTICULAR
PURPOSE. See the above copyright notice for more information.
=====*/
/*
* This small code shows how to use the gdcm.StreamImageReader API
* to read a single (whole) frame at a time
* The API allow extracting a smaller extent of the frame of course.
* It will write out the extracted frame in /tmp/frame.raw
*
* Usage:
* $ bin/ExtractOneFrame.exe input.dcm
*/
using System;
using gdcm;
public class ExtractOneFrame
{
    public static int Main(string[] args)
    {
        string filename = args[0];
        gdcm.StreamImageReader reader = new gdcm.StreamImageReader();
        reader.SetFileName( filename );
        if (!reader.ReadImageInformation()) return 1;
        // Get file infos
        gdcm.File f = reader.GetFile();
        // get some info about image
        UIntArrayType extent = ImageHelper.GetDimensionsValue(f);
        //System.Console.WriteLine( extent[0] );
        uint dimx = extent[0];
        //System.Console.WriteLine( extent[1] );
        uint dimy = extent[1];
        //System.Console.WriteLine( extent[2] );
    }
}

```

```

uint dimz = extent[2];
PixelFormat pf = ImageHelper.GetPixelFormatValue (f);
int pixelsize = pf.GetPixelFormatSize();
//System.Console.WriteLine( pixelsize );
// buffer to get the pixels
byte[] buffer = new byte[ dimx * dimy * pixelsize ];
for (int i = 0; i < dimz; i++)
{
    // Define that I want the image 0, full size (dimx x dimy pixels)
    reader.DefinePixelExtent(0, (ushort)dimx, 0, (ushort)dimy, (ushort)i, (ushort)(i+1));
    uint buf_len = reader.DefineProperBufferLength(); // take into account pixel size
    //System.Console.WriteLine( buf_len );
    if( buf_len > buffer.Length )
    {
        throw new Exception("buffer is too small for target");
    }
    if (reader.Read(buffer, (uint)buffer.Length))
    {
        using (System.IO.Stream stream =
            System.IO.File.Open(@"tmp/frame.raw",
                System.IO.FileMode.Create))
        {
            System.IO.BinaryWriter writer = new System.IO.BinaryWriter(stream);
            writer.Write(buffer);
        }
    }
    else
    {
        throw new Exception("can't read pixels error");
    }
}
return 0;
}
}

```

## 12.24 FileAnonymize.cs

```

/*-----
Program: GDCM (Grassroots DICOM). A DICOM library

Copyright (c) 2006-2011 Mathieu Malaterre
All rights reserved.
See Copyright.txt or http://gdcm.sourceforge.net/Copyright.html for details.

This software is distributed WITHOUT ANY WARRANTY; without even
the implied warranty of MERCHANTABILITY or FITNESS FOR A PARTICULAR
PURPOSE. See the above copyright notice for more information.

-----*/
/*
 * Simple C# example
 *
 * Usage:
 * $ mono bin/FileAnonymize.exe input.dcm output.dcm
 */
using System;
using gdcm;
public class FileAnonymize
{
    public static int Main(string[] args)
    {
        string filename = args[0];
        string outfilename = args[1];
        gdcm.FileAnonymizer fa = new gdcm.FileAnonymizer();
        fa.SetInputFileName( filename );
        fa.SetOutputFileName( outfilename );
        // Empty Operations
        // It will create elements, since those tags are non-registered public elements (2011):
        fa.Empty( new Tag(0x0008,0x1313) );
        fa.Empty( new Tag(0x0008,0x1317) );
        // Remove Operations
        // The following Tag are actually carefully chosen, since they refer to SQ:
        fa.Remove( new Tag(0x0008,0x2112) );
        fa.Remove( new Tag(0x0008,0x9215) );
        // Replace Operations
        // do not call replace operation on SQ attribute !
    }
}

```

```

fa.Replace( new Tag(0x0018,0x5100), "MYVALUE " );
fa.Replace( new Tag(0x0008,0x1160), "MYOTHERVAL" );
if( !fa.Write() )
{
    System.Console.WriteLine( "Could not write" );
    return 1;
}
return 0;
}
}

```

## 12.25 FileChangeTS.cs

```

/*=====
Program: GDCM (Grassroots DICOM). A DICOM library

Copyright (c) 2006-2011 Mathieu Malaterre
All rights reserved.
See Copyright.txt or http://gdcm.sourceforge.net/Copyright.html for details.

This software is distributed WITHOUT ANY WARRANTY; without even
the implied warranty of MERCHANTABILITY or FITNESS FOR A PARTICULAR
PURPOSE. See the above copyright notice for more information.

=====*/
/*
* Simple C# example
*
* Shows multiple steps:
* Steps 1.
* Create a fake (dummy) DICOM file, with size 512 x 512 x 2 We use a small
* image to be able to create the volume in memory Of course you can use any
* existing DICOM instead
*
* Step 2.
* Hack the DICOM file to pretend the number of frames is 1000 (instead of 2)
* At this point in time this makes the DICOM file invalid (truncated). But the
* next step will fix this.
*
* Step 3.
* Use C# to create a binary data which will represent our source object for
* image.
*
* Step 4.
* We use gdcm.FileStreamer to merge the template DICOM file from Step 2, with
* the binary data from Step 3. We decide to read a scanline at a time, but
* this can be read with any number of bytes. AppendToDataElement() will always
* do the proper computation.
*
* Step 5.
* We compress this gigantic file, into [JPEG Lossless, Non-Hierarchical,
* First-Order Prediction (Process 14 [Selection Value 1])]
*
* Usage:
* $ mono bin/FileChangeTS.exe small.dcm big.dcm raw.data merge.dcm jpeg.dcm
*/
using System;
using System.IO;
using gdcm;
public class FileChangeTS
{
    public static byte[] StrToByteArray(string str)
    {
        System.Text.ASCIIEncoding encoding=new System.Text.ASCIIEncoding();
        return encoding.GetBytes(str);
    }
    // Create a 256 x 256 Secondary Capture Image Storage
    static private void CreateSmallDICOM(string fileName)
    {
        using( var writer = new gdcm.PixmapWriter() )
        {
            gdcm.Pixmap img = writer.GetImage();
            img.SetNumberOfDimensions( 3 );
            img.SetDimension(0, 512 );
            img.SetDimension(1, 512 );
            img.SetDimension(2, 2 ); // fake a 3d volume
        }
    }
}

```

```

PhotometricInterpretation pi = new PhotometricInterpretation( PhotometricInterpretation.PIType.MONOCHROME2
);
img.SetPhotometricInterpretation( pi );
gdcm.DataElement pixeldata = new gdcm.DataElement( new gdcm.Tag(0x7fe0,0x0010) );
byte[] buffer = new byte[ 512 * 512 * 2 ];
pixeldata.SetByteValue( buffer, new gdcm.VL((uint)buffer.Length) );
img.SetDataElement( pixeldata );
gdcm.File file = writer.GetFile();
gdcm.DataSet ds = file.GetDataSet();
gdcm.DataElement ms = new gdcm.DataElement(new gdcm.Tag(0x0008,0x0016));
string mediastorage = "1.2.840.10008.5.1.4.1.1.7.2"; // Multi-frame Grayscale Byte Secondary Capture Image
Storage
byte[] val = StrToByteArray(mediastorage);
ms.SetByteValue( val, new gdcm.VL( (uint)val.Length) );
ds.Insert( ms );
writer.SetFileName( fileName );
writer.Write();
}
}
static private void CreateBigDICOM(string fileName, string outfilename)
{
using( var ano = new gdcm.FileAnonymizer() )
{
// The following is somewhat dangerous, do not try at home:
string nframes = "1000";
ano.Replace( new gdcm.Tag(0x0028,0x0008), nframes );
ano.SetInputFileName(fileName);
ano.SetOutputFileName(outfilename);
ano.Write(); // at this point the DICOM is invalid !
}
}
static private void CreateDummyFile(string fileName, long length)
{
using (var fileStream = new FileStream(fileName, FileMode.Create, FileAccess.Write, FileShare.None))
{
// Looks like C# always init to 0 (fallocate ?)
// For the purpose of the test we could add some random noise
fileStream.SetLength(length);
}
}
static private void ReadBytesIntoArray( byte[] array, FileStream source )
{
int numBytesToRead = array.Length;
int numBytesRead = 0;
while (numBytesToRead > 0)
{
// According to spec: Read() may return anything from 0 to numBytesToRead.
int n = source.Read(array, numBytesRead, numBytesToRead);
// Break when the end of the file is reached.
if (n == 0)
break;
numBytesRead += n;
numBytesToRead -= n;
}
}
static private void AssembleDICOMAndRaw(string dicomfn, string rawdata, string outfn)
{
using ( var fs = new gdcm.FileStreamer() )
{
fs.SetTemplateFileName(dicomfn);
fs.SetOutputFileName(outfn);
gdcm.Tag pixeldata = new gdcm.Tag(0x7fe0, 0x0010);
// FileStreamer support automatic checking of pixel data length
// based on DICOM attributes, only if we say so:
fs.CheckDataElement( pixeldata );
// Declare we are working on Pixel Data attribute:
fs.StartDataElement( pixeldata );
using (FileStream rawSource = new FileStream(rawdata,
FileMode.Open, FileAccess.Read))
{
byte[] bytes = new byte[512];
// Only read one scanline at a time
// We could have been reading more at once, if this is more efficient,
// AppendToDataElement will do the logic in all cases.
for( int i = 0; i < 512 * 1000; ++i )
{
// Read the source file into a byte array.
ReadBytesIntoArray( bytes, rawSource );
fs.AppendToDataElement( pixeldata, bytes, (uint)bytes.Length );
}
}
}
}

```

```

        if( !fs.StopDataElement( pixeldata ) )
        {
            // Most likely an issue with Pixel Data Length computation:
            throw new Exception("StopDataElement failed");
        }
    }
}
static private void CompressIntoJPEG(string rawdicom, string jpegdicom)
{
    using( var sfcts = FileChangeTransferSyntax.New() )
    {
        // Need to retrieve the actual C++ reference, to pass to
        // SimpleSubjectWatcher:
        FileChangeTransferSyntax fcts = sfcts.__ref__();
        SimpleSubjectWatcher watcher = new SimpleSubjectWatcher(fcts, "FileChangeTransferSyntax");
        gdcm.TransferSyntax ts = new TransferSyntax( TransferSyntax.TType.JPEGLosslessProcess14_1 );
        fcts.SetTransferSyntax( ts );
        fcts.SetInputFileName( rawdicom );
        fcts.SetOutputFileName( jpegdicom );
        fcts.Change();
    }
}
public static int Main(string[] args)
{
    string filename = args[0];
    string outfilename = args[1];
    string rawfilename = args[2];
    string mergefn = args[3];
    string jpegfn = args[4];
    CreateSmallDICOM(filename);
    CreateBigDICOM(filename, outfilename);
    CreateDummyFile(rawfilename, 512 * 512 * 1000 );
    AssembleDICOMAndRaw(outfilename, rawfilename, mergefn);
    CompressIntoJPEG(mergefn, jpegfn);
    return 0;
}
}

```

## 12.26 FileChangeTSLossy.cs

```

/*=====
Program: GDCM (Grassroots DICOM). A DICOM library

Copyright (c) 2006-2011 Mathieu Malaterre
All rights reserved.
See Copyright.txt or http://gdcm.sourceforge.net/Copyright.html for details.

This software is distributed WITHOUT ANY WARRANTY; without even
the implied warranty of MERCHANTABILITY or FITNESS FOR A PARTICULAR
PURPOSE. See the above copyright notice for more information.

=====*/
/*
 * Simple C# example
 *
 * Shows multiple steps:
 * Steps 1.
 * Create a fake (dummy) DICOM file, with size 512 x 512 x 2 We use a small
 * image to be able to create the volume in memory Of course you can use any
 * existing DICOM instead
 *
 * Step 2.
 * Hack the DICOM file to pretend the number of frames is 1000 (instead of 2)
 * At this point in time this makes the DICOM file invalid (truncated). But the
 * next step will fix this.
 *
 * Step 3.
 * Use C# to create a binary data which will represent our source object for
 * image.
 *
 * Step 4.
 * We use gdcm.FileStreamer to merge the template DICOM file from Step 2, with
 * the binary data from Step 3. We decide to read a scanline at a time, but
 * this can be read with any number of bytes. AppendToDataElement() will always
 * do the proper computation.
 *
 */

```

```

* Step 5.
* We compress this gigantic file, into [JPEG Baseline (Process 1): Default Transfer Syntax for Lossy JPEG 8 Bit
  Image Compression]
*
* Usage:
* $ bin/FileChangeTSLossy.exe small.dcm big.dcm raw.data merge.dcm jpeg.dcm
*/
using System;
using System.IO;
using gdcm;
public class FileChangeTS
{
    public static byte[] StrToByteArray(string str)
    {
        System.Text.ASCIIEncoding encoding=new System.Text.ASCIIEncoding();
        return encoding.GetBytes(str);
    }
    // Create a 256 x 256 Secondary Capture Image Storage
    static private void CreateSmallDICOM(string fileName)
    {
        using( var writer = new gdcm.PixmapWriter() )
        {
            gdcm.Pixmap img = writer.GetImage();
            img.SetNumberOfDimensions( 3 );
            img.SetDimension(0, 512 );
            img.SetDimension(1, 512 );
            img.SetDimension(2, 2 ); // fake a 3d volume
            PhotometricInterpretation pi = new PhotometricInterpretation( PhotometricInterpretation.PIType.MONOCHROME2
            );
            img.SetPhotometricInterpretation( pi );
            gdcm.DataElement pixeldata = new gdcm.DataElement( new gdcm.Tag(0x7fe0,0x0010) );
            byte[] buffer = new byte[ 512 * 512 * 2 ];
            pixeldata.SetByteValue( buffer, new gdcm.VL((uint)buffer.Length) );
            img.SetDataElement( pixeldata );
            gdcm.File file = writer.GetFile();
            gdcm.DataSet ds = file.GetDataSet();
            gdcm.DataElement ms = new gdcm.DataElement(new gdcm.Tag(0x0008,0x0016));
            string mediastorage = "1.2.840.10008.5.1.4.1.1.7.2"; // Multi-frame Grayscale Byte Secondary Capture Image
            Storage
            byte[] val = StrToByteArray(mediastorage);
            ms.SetByteValue( val, new gdcm.VL( (uint)val.Length) );
            ds.Insert( ms );
            writer.SetFileName( fileName );
            writer.Write();
        }
    }
    static private void CreateBigDICOM(string fileName, string outfilename)
    {
        using( var ano = new gdcm.FileAnonymizer() )
        {
            // The following is somewhat dangerous, do not try at home:
            string nframes = "1000";
            ano.Replace( new gdcm.Tag(0x0028,0x0008), nframes );
            ano.SetInputFileName( fileName );
            ano.SetOutputFileName( outfilename );
            ano.Write(); // at this point the DICOM is invalid !
        }
    }
    static private void CreateDummyFile(string fileName, long length)
    {
        using (var fileStream = new FileStream(fileName, FileMode.Create, FileAccess.Write, FileShare.None))
        {
            // Looks like C# always init to 0 (fallocate ?)
            // For the purpose of the test we could add some random noise
            fileStream.SetLength(length);
        }
    }
    static private void ReadBytesIntoArray( byte[] array, FileStream source )
    {
        int numBytesToRead = array.Length;
        int numBytesRead = 0;
        while (numBytesToRead > 0)
        {
            // According to spec: Read() may return anything from 0 to numBytesToRead.
            int n = source.Read(array, numBytesRead, numBytesToRead);
            // Break when the end of the file is reached.
            if (n == 0)
                break;
            numBytesRead += n;
            numBytesToRead -= n;
        }
    }
}

```



```

    }
    static private void AssembleDICOMAndRaw(string dicomfn, string rawdata, string outfn)
    {
        using ( var fs = new gdcm.FileStreamer() )
        {
            fs.SetTemplateFileName(dicomfn);
            fs.SetOutputFileName(outfn);
            gdcm.Tag pixeldata = new gdcm.Tag(0x7fe0, 0x0010);
            // FileStreamer support automatic checking of pixel data length
            // based on DICOM attributes, only if we say so:
            fs.CheckDataElement( pixeldata );
            // Declare we are working on Pixel Data attribute:
            fs.StartDataElement( pixeldata );
            using (FileStream rawSource = new FileStream(rawdata,
                FileMode.Open, FileAccess.Read))
            {
                byte[] bytes = new byte[512];
                // Only read one scanline at a time
                // We could have been reading more at once, if this is more efficient,
                // AppendToDataElement will do the logic in all cases.
                for( int i = 0; i < 512 * 1000; ++i )
                {
                    // Read the source file into a byte array.
                    ReadBytesIntoArray( bytes, rawSource );
                    fs.AppendToDataElement( pixeldata, bytes, (uint)bytes.Length );
                }
            }
            if ( !fs.StopDataElement( pixeldata ) )
            {
                // Most likely an issue with Pixel Data Length computation:
                throw new Exception("StopDataElement failed");
            }
        }
    }
    static private void CompressIntoJPEG(string rawdicom, string jpegdicom)
    {
        using( var sfcts = FileChangeTransferSyntax.New() )
        {
            // Need to retrieve the actual C++ reference, to pass to
            // SimpleSubjectWatcher:
            FileChangeTransferSyntax fcts = sfcts.__ref__();
            SimpleSubjectWatcher watcher = new SimpleSubjectWatcher(fcts, "FileChangeTransferSyntax");
            gdcm.TransferSyntax ts = new TransferSyntax( TransferSyntax.TType.JPEGBaselineProcess1 );
            fcts.SetTransferSyntax( ts );
            ImageCodec ic = fcts.GetCodec();
            JPEGCodec jpeg = JPEGCodec.Cast( ic );
            jpeg.SetLossless( false );
            jpeg.SetQuality( 50 ); // poor quality !
            fcts.SetInputFileName( rawdicom );
            fcts.SetOutputFileName( jpegdicom );
            fcts.Change();
        }
    }
    public static int Main(string[] args)
    {
        string filename = args[0];
        string outfilename = args[1];
        string rawfilename = args[2];
        string mergefn = args[3];
        string jpegfn = args[4];
        CreateSmallDICOM(filename);
        CreateBigDICOM(filename, outfilename);
        CreateDummyFile(rawfilename, 512 * 512 * 1000 );
        AssembleDICOMAndRaw(outfilename, rawfilename, mergefn);
        CompressIntoJPEG(mergefn, jpegfn);
        return 0;
    }
}

```

## 12.27 FileStreaming.cs

```

/*=====
Program: GDCM (Grassroots DICOM). A DICOM library

Copyright (c) 2006-2011 Mathieu Malaterre
All rights reserved.

```

See Copyright.txt or <http://gdc.sourceforge.net/Copyright.html> for details.

This software is distributed WITHOUT ANY WARRANTY; without even the implied warranty of MERCHANTABILITY or FITNESS FOR A PARTICULAR PURPOSE. See the above copyright notice for more information.

```

=====*/
/*
 * Simple C# example
 *
 * Usage:
 * $ mono bin/FileStreaming.exe gdcData/CT_16b_signed-UsedBits13.dcm output.dcm
 *
 * The class will take care of group handling and will use the first available group:
 * (0009,0012) ?? (LO) [MYTEST] # 6,1 Private Creator
 */
using System;
using gdc;
public class FileStreaming
{
    public static int Main(string[] args)
    {
        string filename = args[0];
        string outfilename = args[1];
        gdc.PrivateTag pt = new gdc.PrivateTag( new gdc.Tag(0x9,0x10), "MYTEST" );
        gdc.FileStreamer fs = new gdc.FileStreamer();
        fs.SetTemplateFileName( filename );
        fs.SetOutputFileName( outfilename );
        byte[] buffer = new byte[ 8192 ];
        uint len = (uint)buffer.Length;
        // In this example, we want that each newly created Private Attribute
        // contains at most 1000 bytes of incoming dataset.
        // We are also calling the function twice to check that appending mode is
        // working from one call to the other. The last element will have a length
        // of (2 * 8192) % 1000 = 384
        if( !fs.StartGroupDataElement( pt, 1000, 1 )
            || !fs.AppendToGroupDataElement( pt, buffer, len )
            || !fs.AppendToGroupDataElement( pt, buffer, len )
            || !fs.StopGroupDataElement( pt ) )
        {
            System.Console.WriteLine( "Could not change private group" );
            return 1;
        }
        return 0;
    }
}

```

## 12.28 GetArray.cs

```

/*=====
Program: GDCM (Grassroots DICOM). A DICOM library

Copyright (c) 2006-2011 Mathieu Malaterre
All rights reserved.
See Copyright.txt or http://gdc.sourceforge.net/Copyright.html for details.

This software is distributed WITHOUT ANY WARRANTY; without even
the implied warranty of MERCHANTABILITY or FITNESS FOR A PARTICULAR
PURPOSE. See the above copyright notice for more information.

=====*/
/*
 * Usage:
 * $ export LD_LIBRARY_PATH=$HOME/Projects/gdc/debug-gcc/bin
 * $ mono bin/GetArray.exe gdcData/012345.002.050.dcm
 */
using System;
using gdc;
public class GetArray
{
    public static int Main(string[] args)
    {
        string file1 = args[0];
        ImageReader reader = new ImageReader();
        reader.SetFileName( file1 );
        bool ret = reader.Read();
    }
}

```

```

if( !ret )
{
    return 1;
}
Image image = reader.GetImage();
PixelFormat pixeltype = image.GetPixelFormat();
if( image.GetNumberOfDimensions() != 2 )
{
    // For the purpose of the test, exit early on
    return 1;
}
uint dimx = image.GetDimension(0);
uint dimy = image.GetDimension(1);
uint npixels = dimx * dimy;
//LookupTable lut = image.GetLUT();
//uint rl = lut.GetLUTLength( LookupTable.LookupTableType.RED );
//byte[] rbuf = new byte[ rl ];
//uint rl2 = lut.GetLUT( LookupTable.LookupTableType.RED, rbuf );
//assert rl == rl2;
//byte[] str1 = new byte[ image.GetBufferLength()];
//image.GetBuffer( str1 );
if( pixeltype.GetScalarType() == PixelFormat.ScalarType.UINT8 )
{
    System.Console.WriteLine( "Processing UINT8 image type" );
    byte[] str1 = new byte[ npixels ];
    image.GetArray( str1 );
}
else if( pixeltype.GetScalarType() == PixelFormat.ScalarType.INT16 )
{
    System.Console.WriteLine( "Processing INT16 image type" );
    short[] str1 = new short[ npixels ];
    image.GetArray( str1 );
}
else if( pixeltype.GetScalarType() == PixelFormat.ScalarType.UINT16 )
{
    System.Console.WriteLine( "Processing UINT16 image type" );
    ushort[] str1 = new ushort[ npixels ];
    image.GetArray( str1 );
}
else
{
    //System.Console.WriteLine( "Default (unhandled pixel format): " + pixeltype.toString() );
    System.Console.WriteLine( "Default (unhandled pixel format): " + pixeltype.GetScalarTypeAsString() );
    // Get bytes
    byte[] str1 = new byte[ image.GetBufferLength()];
    image.GetBuffer( str1 );
}
return 0;
}
}

```

## 12.29 MpegVideoInfo.cs

```

/*=====
Program: GDCM (Grassroots DICOM). A DICOM library

Copyright (c) 2006-2011 Mathieu Malaterre
All rights reserved.
See Copyright.txt or http://gdcm.sourceforge.net/Copyright.html for details.

This software is distributed WITHOUT ANY WARRANTY; without even
the implied warranty of MERCHANTABILITY or FITNESS FOR A PARTICULAR
PURPOSE. See the above copyright notice for more information.

=====*/
/*
* This examples takes in a MPEG2 and write out a Video Endoscopic Image Storage
* encoded using MPEG2 @ Main Profile
* ref: http://chrisa.wordpress.com/2007/11/21/decoding-mpeg2-information/
* See also:
* http://dvd.sourceforge.net/dvdinfo/mpeghdrs.html#gop
* http://cvs.linux.hr/cgi-bin/viewcvs.cgi/mpeg_mod/README.informpeg?view=markup
* http://www.guru-group.fi/~too/sw/m2vmp2cut/mpeg2info.c
*/
/*
* Provides information about an MPEG2 file, including the duration, frame rate, aspect

```

```

* ratio, and resolution. Good information about the MPEG2 file structure that helps
* explain parts of the code can be found here:
* http://dvd.sourceforge.net/dvdinfo/mpeghdrs.html#gop
*
* Copyright (c) 2007 Chris Anderson (chrisa@wordpress.com)
*
* This library is free software; you can redistribute it and/or
* modify it under the terms of the GNU Lesser General Public
* License as published by the Free Software Foundation; either
* version 2 of the License, or (at your option) any later version.
*
* This library is distributed in the hope that it will be useful,
* but WITHOUT ANY WARRANTY; without even the implied warranty of
* MERCHANTABILITY or FITNESS FOR A PARTICULAR PURPOSE. See the GNU
* Lesser General Public License for more details.
*/
using System;
using System.IO;
using gdc;
public class Mpeg2VideoInfo
{
    #region Member Variables
    private TimeSpan m_startTime = TimeSpan.Zero;
    private TimeSpan m_endTime = TimeSpan.Zero;
    private TimeSpan m_duration = TimeSpan.Zero;
    private eAspectRatios m_aspectRatio = eAspectRatios.Invalid;
    private eFrameRates m_frameRate = 0;
    private int m_pictureWidth = 0;
    private int m_pictureHeight = 0;
    #endregion
    #region Constants
    private const byte PADDING_PACKET = 0xBE;
    private const byte VIDEO_PACKET = 0xE0;
    private const byte AUDIO_PACKET = 0xC0;
    private const byte SYSTEM_PACKET = 0xBB;
    private const byte TIMESTAMP_PACKET = 0xB8;
    private const byte HEADER_PACKET = 0xB3;
    private const int BUFFER_SIZE = 8162; // 8K buffer
    private readonly static TimeSpan EMPTY_TIMESPAN = new TimeSpan(0, 0, -1);
    #endregion
    #region Enumerations
    public enum eFrameRates
    {
        Invalid,
        PulldownNTSC, // 24000d/1001d = 23.976 Hz
        Film, // 24 Hz
        PAL, // 25 Hz
        NTSC, // 30000d/1001d = 29.97 Hz
        DropFrameNTSC, // 30 Hz
        DoubleRatePAL, // 50 Hz
        DoubleRateNTSC, // 59.97 Hz
        DoubleRateDropFrameNTSC // 60 Hz
    }
    public enum eAspectRatios
    {
        Invalid,
        VGA, // 1/1
        StandardTV, // 4/3
        LargeTV, // 16/9
        Cinema // 2.21/1
    }
    #endregion
    #region Constructor
    public Mpeg2VideoInfo(string file)
    {
        ParseMpeg(file);
    }
    #endregion
    #region Public Properties
    public TimeSpan StartTime
    {
        get { return m_startTime; }
    }
    public TimeSpan EndTime
    {
        get { return m_endTime; }
    }
    public TimeSpan Duration
    {
        get { return m_duration; }
    }
}

```

```

public eAspectRatios AspectRatio
{
    get { return m_aspectRatio; }
}
public eFrameRates FrameRate
{
    get { return m_frameRate; }
}
public int PictureWidth
{
    get { return m_pictureWidth; }
}
public int PictureHeight
{
    get { return m_pictureHeight; }
}
#endregion
#region Private Functions
private void ParseMpeg(string file)
{
    FileStream fs = new FileStream(file, FileMode.Open, FileAccess.Read, FileShare.ReadWrite);
    BinaryReader br = new BinaryReader(fs);
    m_startTime = GetStartTimeStampInfo(br);
    m_endTime = GetEndTimeStampInfo(br);
    m_duration = m_endTime.Subtract(m_startTime);
    GetHeaderInfo(br);
    br.Close();
    fs.Close();
}
private TimeSpan GetStartTimeStampInfo(BinaryReader br)
{
    TimeSpan startTime = EMPTY_TIMESPAN;
    byte[] buffer = new byte[BUFFER_SIZE];
    br.BaseStream.Seek(0, SeekOrigin.Begin);
    while (startTime == EMPTY_TIMESPAN && br.BaseStream.Position < br.BaseStream.Length)
    {
        int readBytes = br.Read(buffer, 0, BUFFER_SIZE);
        for (int offset = 0; offset < readBytes - 8; offset++)
        {
            if (IsStreamMarker(ref buffer, offset, TIMESTAMP_PACKET))
            {
                offset += 4; // Move to the data position which follows the stream header
                uint timeStampEncoded = GetData(ref buffer, offset);
                startTime = DecodeTimeStamp(timeStampEncoded);
                if (startTime != EMPTY_TIMESPAN)
                    break;
            }
        }
    }
    return startTime;
}
private TimeSpan GetEndTimeStampInfo(BinaryReader br)
{
    TimeSpan endTime = EMPTY_TIMESPAN;
    byte[] buffer = new byte[BUFFER_SIZE];
    br.BaseStream.Seek(-BUFFER_SIZE, SeekOrigin.End);
    while (endTime == EMPTY_TIMESPAN && br.BaseStream.Position > BUFFER_SIZE)
    {
        int readBytes = br.Read(buffer, 0, BUFFER_SIZE);
        for (int offset = readBytes - 8; offset >= 0; offset--)
        {
            if (IsStreamMarker(ref buffer, offset, TIMESTAMP_PACKET))
            {
                offset += 4; // Move to the data position which follows the stream header
                uint timeStampEncoded = GetData(ref buffer, offset);
                endTime = DecodeTimeStamp(timeStampEncoded);
                if (endTime != EMPTY_TIMESPAN)
                    break;
            }
        }
        br.BaseStream.Seek(-BUFFER_SIZE * 2, SeekOrigin.Current);
    }
    return endTime;
}
private TimeSpan DecodeTimeStamp(uint timeStampEncoded)
{
    TimeSpan timeStamp = EMPTY_TIMESPAN;
    // Mask out the bits containing the property we are after, then
    // shift the data to the right to get its value
    int hour = (int)(timeStampEncoded & 0x7C000000) » 26; // Bits 31 -> 27
    int minute = (int)(timeStampEncoded & 0x03F00000) » 20; // Bits 26 -> 21
}

```

```

    int second = (int)(timeStampEncoded & 0x0007E000) >> 13; // Bits 19 -> 14
    int frame = (int)(timeStampEncoded & 0x00001F80) >> 7; // Bits 13 -> 8 - not used, but included for
    completeness
    timeStamp = new TimeSpan(hour, minute, second);
    return timeStamp;
}
private void GetHeaderInfo(BinaryReader br)
{
    byte[] buffer = new byte[BUFFER_SIZE];
    br.BaseStream.Seek(0, SeekOrigin.Begin);
    br.Read(buffer, 0, BUFFER_SIZE);
    for (int offset = 0; offset < buffer.Length - 4; offset++)
    {
        if (IsStreamMarker(ref buffer, offset, HEADER_PACKET))
        {
            offset += 4; // Move to the data position which follows the stream header
            uint headerData = GetData(ref buffer, offset);
            // Mask out the bits containing the property we are after, then
            // shift the data to the right to get its value
            m_pictureWidth = (int)(headerData & 0xFFF00000) >> 20;
            m_pictureHeight = (int)(headerData & 0x000FFF00) >> 8;
            uint aspectRatioIndex = (headerData & 0x000000F0) >> 4;
            uint fpsIndex = headerData & 0x0000000F;
            m_aspectRatio = (eAspectRatios)fpsIndex;
            m_frameRate = (eFrameRates)fpsIndex;
            break;
        }
    }
}
private uint GetData(ref byte[] buffer, int offset)
{
    return (uint) ((buffer[offset] << 24) |
                  (buffer[offset + 1] << 16) |
                  (buffer[offset + 2] << 8) |
                  (buffer[offset + 3]));
}
private bool IsStreamMarker(ref byte[] buffer, int offset, byte markerType)
{
    return (buffer[offset] == 0x00 &&
            buffer[offset + 1] == 0x00 &&
            buffer[offset + 2] == 0x01 &&
            buffer[offset + 3] == markerType);
}
#endregion
public static int Main(string[] args)
{
    string file1 = args[0];
    Mpeg2VideoInfo info = new Mpeg2VideoInfo(file1);
    System.Console.WriteLine( info.StartTime );
    System.Console.WriteLine( info.EndTime );
    System.Console.WriteLine( info.Duration );
    System.Console.WriteLine( info.AspectRatio );
    System.Console.WriteLine( info.FrameRate );
    System.Console.WriteLine( info.PictureWidth );
    System.Console.WriteLine( info.PictureHeight );
    ImageReader r = new ImageReader();
    //Image image = new Image();
    Image image = r.GetImage();
    image.SetNumberOfDimensions( 3 );
    DataElement pixeldata = new DataElement( new gdcm.Tag(0x7fe0,0x0010) );
    System.IO.FileStream infile =
        new System.IO.FileStream(file1, System.IO.FileMode.Open, System.IO.FileAccess.Read);
    uint fsize = gdcm.PosixEmulation.FileSize(file1);
    byte[] jstream = new byte[fsize];
    infile.Read(jstream, 0, jstream.Length);
    SmartPtrFrag sq = SequenceOfFragments.New();
    Fragment frag = new Fragment();
    frag.SetByteValue( jstream, new gdcm.VL( (uint)jstream.Length) );
    sq.AddFragment( frag );
    pixeldata.SetValue( sq.__ref__() );
    // insert:
    image.SetDataElement( pixeldata );
    PhotometricInterpretation pi = new PhotometricInterpretation(
        PhotometricInterpretation.PIType.YBR_PARTIAL_420 );
    image.SetPhotometricInterpretation( pi );
    // FIXME hardcoded:
    PixelFormat pixeltype = new PixelFormat(3,8,8,7);
    image.SetPixelFormat( pixeltype );
    // FIXME hardcoded:
    TransferSyntax ts = new TransferSyntax( TransferSyntax.TSType.MPEG2MainProfile);
    image.SetTransferSyntax( ts );
}

```

```

image.SetDimension(0, (uint)info.PictureWidth);
image.SetDimension(1, (uint)info.PictureHeight);
image.SetDimension(2, 721);
ImageWriter writer = new ImageWriter();
gdcm.File file = writer.GetFile();
file.GetHeader().SetDataSetTransferSyntax( ts );
Anonymizer anon = new Anonymizer();
anon.SetFile( file );
MediaStorage ms = new MediaStorage( MediaStorage.MSType.VideoEndoscopicImageStorage);
UIDGenerator gen = new UIDGenerator();
anon.Replace( new Tag(0x0008,0x16), ms.GetString() );
anon.Replace( new Tag(0x0018,0x40), "25" );
anon.Replace( new Tag(0x0018,0x1063), "40.000000" );
anon.Replace( new Tag(0x0028,0x34), "4\\3" );
anon.Replace( new Tag(0x0028,0x2110), "01" );
writer.SetImage( image );
writer.SetFileName( "dummy.dcm" );
if( !writer.Write() )
{
    System.Console.WriteLine( "Could not write" );
    return 1;
}
return 0;
}
}

```

## 12.30 NewSequence.cs

```

/*=====
Program: GDCM (Grassroots DICOM). A DICOM library

Copyright (c) 2006-2011 Mathieu Malaterre
All rights reserved.
See Copyright.txt or http://gdcm.sourceforge.net/Copyright.html for details.

This software is distributed WITHOUT ANY WARRANTY; without even
the implied warranty of MERCHANTABILITY or FITNESS FOR A PARTICULAR
PURPOSE. See the above copyright notice for more information.

=====*/
/*
 * Usage:
 * $ export LD_LIBRARY_PATH=$HOME/Projects/gdcm/debug-gcc/bin
 * $ mono bin/NewSequence.exe gdcmData/012345.002.050.dcm out.dcm
 */
using System;
//using gdcm;
public class NewSequence
{
    public static byte[] StrToByteArray(string str)
    {
        System.Text.ASCIIEncoding encoding=new System.Text.ASCIIEncoding();
        return encoding.GetBytes(str);
    }
    public static int Main(string[] argv)
    {
        string file1 = argv[0];
        string file2 = argv[1];
        gdcm.Reader r = new gdcm.Reader();
        r.SetFileName( file1 );
        if ( ! r.Read() )
        {
            return 1;
        }
        gdcm.File f = r.GetFile();
        gdcm.DataSet ds = f.GetDataSet();
        // tsis = gdcm.Tag(0x0008,0x2112) # SourceImageSequence
        // Create a dataelement
        gdcm.DataElement de = new gdcm.DataElement(new gdcm.Tag(0x0010, 0x2180));
        string occ = "Occupation";
        de.SetByteValue( StrToByteArray(occ), new gdcm.VL((uint)occ.Length));
        de.SetVR(new gdcm.VR(gdcm.VR.VRType.SH));
        // Create an item
        gdcm.Item it = new gdcm.Item();
        it.SetVLToUndefined(); // Needed to not popup error message
        //it.InsertDataElement(de)

```

```

gdcM.DataSet nds = it.GetNestedDataSet();
nds.Insert(de);
// Create a Sequence
gdcM.SmartPtrSQ sq = gdcM.SequenceOfItems.New();
sq.SetLengthToUndefined();
sq.AddItem(it);
// Insert sequence into data set
gdcM.DataElement des = new gdcM.DataElement(new gdcM.Tag(0x0400,0x0550));
des.SetVR(new gdcM.VR(gdcM.VR.VRType.SQ));
des.SetValue(sq.__ref__());
des.SetVLToUndefined();
ds.Insert(des);
gdcM.Writer w = new gdcM.Writer();
w.SetFile( f );
w.SetFileName( file2 );
if ( !w.Write() )
    return 1;
return 0;
}
}

```

## 12.31 RescaleImage.cs

```

/*=====
Program: GDCM (Grassroots DICOM). A DICOM library

Copyright (c) 2006-2011 Mathieu Malaterre
All rights reserved.
See Copyright.txt or http://gdcM.sourceforge.net/Copyright.html for details.

This software is distributed WITHOUT ANY WARRANTY; without even
the implied warranty of MERCHANTABILITY or FITNESS FOR A PARTICULAR
PURPOSE. See the above copyright notice for more information.

=====*/
/*
 * Usage:
 * $ export LD_LIBRARY_PATH=$HOME/Projects/gdcM/debug-gcc/bin
 * $ mono bin/DecompressImage.exe gdcMData/012345.002.050.dcm rescaled.dcm
 */
using System;
using gdcM;
public class DecompressImage
{
    public static int Main(string[] args)
    {
        string file1 = args[0];
        ImageReader reader = new ImageReader();
        reader.SetFileName( file1 );
        bool ret = reader.Read();
        if( !ret )
        {
            return 1;
        }
        Image image = reader.GetImage();
        PixelFormat pixeltype = image.GetPixelFormat();
        Rescaler r = new Rescaler();
        r.SetIntercept( 0 );
        r.SetSlope( 1.2 );
        r.SetPixelFormat( pixeltype );
        PixelFormat outputpt = new PixelFormat( r.ComputeInterceptSlopePixelFormat() );
        System.Console.WriteLine( "pixeltype" );
        System.Console.WriteLine( pixeltype.ToString() );
        System.Console.WriteLine( "outputpt" );
        System.Console.WriteLine( outputpt.ToString() );
        uint len = image.GetBufferLength();
        short[] input = new short[ len / 2 ]; // sizeof(short) == 2
        image.GetArray( input );
        double[] output = new double[ len / 2 ];
        r.Rescale( output, input, len );
        // First Pixel is:
        System.Console.WriteLine( "Input:" );
        System.Console.WriteLine( input[0] );
        System.Console.WriteLine( "Output:" );
        System.Console.WriteLine( output[0] );
        return 0;
    }
}

```



```

    }
}

```

## 12.32 SendFileSCU.cs

```

/*=====
Program: GDCM (Grassroots DICOM). A DICOM library

Copyright (c) 2006-2011 Mathieu Malaterre
All rights reserved.
See Copyright.txt or http://gdcm.sourceforge.net/Copyright.html for details.

This software is distributed WITHOUT ANY WARRANTY; without even
the implied warranty of MERCHANTABILITY or FITNESS FOR A PARTICULAR
PURPOSE. See the above copyright notice for more information.

=====*/
/*
 * Usage:
 * $ export LD_LIBRARY_PATH=$HOME/Perso/gdcm-gcc/bin
 * $ mono bin/SendFileSCU.exe server port input.dcm
 */
using System;
using gdcm;
public class SendFileSCU
{
    public static int Main(string[] args)
    {
        string server = args[0];
        ushort port = ushort.Parse(args[1]);
        string filename = args[2];
        bool b = CompositeNetworkFunctions.CEcho( server, port );
        if( !b ) return 1;
        FilenamesType files = new FilenamesType();
        files.Add( filename );
        b = CompositeNetworkFunctions.CStore( server, port, files );
        if( !b ) return 1;
        return 0;
    }
}

```

## 12.33 SimplePrintPatientName.cs

```

/*=====
Program: GDCM (Grassroots DICOM). A DICOM library

Copyright (c) 2006-2011 Mathieu Malaterre
All rights reserved.
See Copyright.txt or http://gdcm.sourceforge.net/Copyright.html for details.

This software is distributed WITHOUT ANY WARRANTY; without even
the implied warranty of MERCHANTABILITY or FITNESS FOR A PARTICULAR
PURPOSE. See the above copyright notice for more information.

=====*/
/*
 * Usage:
 * $ export LD_LIBRARY_PATH=$HOME/Perso/gdcm/debug-gcc/bin
 * $ mono bin/SimplePrintPatientName.exe gdcmData/012345.002.050.dcm
 */
/*
This example was provided by Jonathan Morra /jonmorra gmail com/
on the gdcm mailing list (Fri, 28 May 2010)
*/
using System;
using gdcm;
namespace GDCMTest
{
    class SimplePrintPatientName
    {
        static int Main(string[] args)

```

```

    {
    if (args.Length != 1)
    {
        Console.WriteLine("This program prints the patient name of a dicom file with gdcM");
        Console.WriteLine("Usage: [input.dcm]");
        return 1;
    }
    gdcM.Reader reader = new gdcM.Reader();
    reader.SetFileName(args[0]);
    bool ret = reader.Read();
    //TagSetType tst = new TagSetType();
    //tst.Add( new Tag(0x7fe0,0x10) );
    //bool ret = reader.ReadUpToTag( new Tag(0x88,0x200), tst );
    if( !ret )
    {
        return 1;
    }
    gdcM.File file = reader.GetFile();
    gdcM.StringFilter filter = new gdcM.StringFilter();
    filter.SetFile(file);
    string value = filter.ToString(new gdcM.Tag(0x0010, 0x0010));
    Console.WriteLine("Patient Name: " + value);
    return 0;
    }
}

```

## 12.34 SortImage2.cs

```

/*=====
Program: GDCM (Grassroots DICOM). A DICOM library

Copyright (c) 2006-2011 Mathieu Malaterre
All rights reserved.
See Copyright.txt or http://gdcM.sourceforge.net/Copyright.html for details.

This software is distributed WITHOUT ANY WARRANTY; without even
the implied warranty of MERCHANTABILITY or FITNESS FOR A PARTICULAR
PURPOSE. See the above copyright notice for more information.

=====*/
/*
 * Usage:
 * $ export LD_LIBRARY_PATH=$HOME/Projects/gdcM/debug-gcc/bin
 * $ mono bin/SortImage.exe gdcMData/012345.002.050.dcm out.dcm
 */
using System;
using gdcM;
public class SortImage2
{
    bool mysort(DataSet ds1, DataSet ds2)
    {
        return false;
    }
    public static int Main(string[] args)
    {
        Sorter sorter = new Sorter();
        sorter.SetSortFunction( mysort );
        return 0;
    }
}

```

## 12.35 CStoreQtProgress.cxx

```

/*=====
Program: GDCM (Grassroots DICOM). A DICOM library

Copyright (c) 2006-2011 Mathieu Malaterre
All rights reserved.
See Copyright.txt or http://gdcM.sourceforge.net/Copyright.html for details.

```

This software is distributed WITHOUT ANY WARRANTY; without even the implied warranty of MERCHANTABILITY or FITNESS FOR A PARTICULAR PURPOSE. See the above copyright notice for more information.

```

=====*/
/*
 * This small example show how one can use the virtual function
 * mechanism of the SimpleSubjectWatcher class to redirect progress
 * report to a custom Qt classes
 *
 * http://doc.qt.nokia.com/latest/qprogressdialog.html
 *
 * Usage:
 * CStoreQtProgress dicom.example.com 11112 gdcData/MR_Spectroscopy_SIEMENS_OF.dcm
 *
 */
#include "gdcServiceClassUser.h"
#include "gdcSimpleSubjectWatcher.h"
#include "gdcProgressEvent.h"
#include "gdcDirectory.h"
#include "gdcPresentationContextGenerator.h"
#include <QApplication>
#include <QProgressDialog>
#include <QVBoxLayout>
namespace gdc {
/*
 * This class is a little more complicated than what this example demonstrate
 * This watcher is capable of handling nested progress. Since the Progress
 * grows from [0 to 1] on a per file basis and we only have one instance of a
 * watcher per association, we need some calculation to compute the global
 * (total) progress
 * In fact we simply divide the per-file progress by the number of files.
 *
 * This QtWatcher class will then update the progress bar according to the
 * progress.
 */
class MyQtWatcher : public SimpleSubjectWatcher
{
    size_t nfiles;
    double progress;
    size_t index;
    double refprogress;
    QWidget* win;
    QProgressDialog* qtprogress;
public:
    MyQtWatcher(Subject * s, const char *comment = "", QWidget *w = NULL, QProgressDialog* p = NULL, size_t n =
        1):
        SimpleSubjectWatcher(s,comment),nfiles(n),progress(0),index(0),refprogress(0),win(w),qtprogress(p) {}
    void ShowIteration()
    {
        index++;
        assert( index <= nfiles );
        // update refprogress (we are moving to the next file)
        refprogress = progress;
    }
    void ShowProgress(Subject *, const Event &evt)
    {
        // Retrieve the ProgressEvent:
        const ProgressEvent &pe = dynamic_cast<const ProgressEvent&>(evt);
        // compute global progress:
        progress = refprogress + (1. / (double)nfiles ) * pe.GetProgress();
        // Print Global and local progress to stdout:
        std::cout << "Global Progress: " << progress << " per file progress " << pe.GetProgress() << std::endl;
        //set progress value in the QtProgress bar
        int i = (int)(progress * 100 + 0.5); // round to next int
        qtprogress->setValue(i);
        win->show();
    }
    virtual void ShowDataSet(Subject *caller, const Event &evt)
    {
        (void)caller;
        (void)evt;
    }
};
} // end namespace gdc
int main(int argc, char *argv[])
{
    if( argc < 4 )
    {
        std::cerr << argv[0] << " remote_server port filename" << std::endl;
        return 1;
    }
}

```

```

    }
    QApplication a(argc, argv);
    std::ostream error_log;
    gdcm::Trace::SetErrorStream( error_log );
    const char *remote = argv[1];
    int portno = atoi(argv[2]);
    const char *filename = argv[3];
    QVBoxLayout* layout = new QVBoxLayout;
    QWidget* win = new QWidget;
    QProgressDialog* progress = new QProgressDialog("Sending data...", "Cancel", 0, 100);
    progress->setWindowModality(Qt::WindowModal);
    layout->addWidget(progress, Qt::AlignCenter);
    win->setLayout(layout);
    gdcm::SmartPointer<gdcm::ServiceClassUser> scup = new gdcm::ServiceClassUser;
    gdcm::ServiceClassUser &scu = *scup;
    //gdcm::SimpleSubjectWatcher w( &scu, "TestServiceClassUser" );
    // let's use a more complicated progress reported in this example
    gdcm::MyQtWatcher w( &scu, "QtWatcher", win, progress );
    scu.SetHostname( remote );
    scu.SetPort( (uint16_t)portno );
    scu.SetTimeout( 1000 );
    scu.SetCalledAETitle( "GDCM_STORE" );
    if( !scu.InitializeConnection() )
    {
        std::cerr << "Could not InitializeConnection" << std::endl;
        return 1;
    }
    gdcm::Directory::FileNamesType filenames;
    filenames.push_back( filename );
    // setup the PC(s) based on the filenames:
    gdcm::PresentationContextGenerator generator;
    if( !generator.GenerateFromFileNames(filenames) )
    {
        std::cerr << "Could not GenerateFromFileNames" << std::endl;
        return 1;
    }
    // Setup PresentationContext(s)
    scu.SetPresentationContexts( generator.GetPresentationContexts() );
    // Start ASSOCIATION
    if( !scu.StartAssociation() )
    {
        std::cerr << "Could not Start" << std::endl;
        return 1;
    }
    // Send C-STORE
    if( !scu.SendStore( filename ) )
    {
        std::cerr << "Could not Store" << std::endl;
        std::cerr << "Error log is:" << std::endl;
        std::cerr << error_log.str() << std::endl;
        return 1;
    }
    // Stop ASSOCIATION
    if( !scu.StopAssociation() )
    {
        std::cerr << "Could not Stop" << std::endl;
        return 1;
    }
    win->show();
    return a.exec();
}

```

## 12.36 ChangePrivateTags.cxx

```

/*=====
Program: GDCM (Grassroots DICOM). A DICOM library

Copyright (c) 2006-2011 Mathieu Malaterre
All rights reserved.
See Copyright.txt or http://gdcm.sourceforge.net/Copyright.html for details.

This software is distributed WITHOUT ANY WARRANTY; without even
the implied warranty of MERCHANTABILITY or FITNESS FOR A PARTICULAR
PURPOSE. See the above copyright notice for more information.

=====*/

```

```

#include "gdcmReader.h"
#include "gdcmWriter.h"
#include "gdcmPrivateTag.h"
int main(int argc, char* argv[] )
{
    if( argc < 3 )
    {
        std::cerr << argv[0] << " path/to/05148044-mr-siemens-avanto-syngo.dcm output.dcm" << std::endl;
        return 1;
    }
    const char *filename = argv[1];
    const char *outfilename = argv[2];
    gdcm::Reader reader;
    reader.SetFileName( filename );
    if (! reader.Read() )
    {
        return 1;
    }
    // (0029,0010) LO [SIEMENS CSA HEADER] # 18,1 Private Creator
    // (0029,0011) LO [SIEMENS MEDCOM HEADER ] # 22,1 Private Creator
    // (0029,0012) LO [SIEMENS MEDCOM HEADER2] # 22,1 Private Creator
    // [...]
    // (0029,1018) CS [MR] # 2,1 CSA Series Header Type
    // (0029,1134) CS [DB TO DICOM ] # 12,1 PMTF Information 4
    // (0029,1260) LO [com ] # 4,1 Series Workflow Status
    gdcm::File &file = reader.GetFile();
    gdcm::DataSet &ds = file.GetDataSet();
    // Declare private tag we need to find:
    gdcm::PrivateTag pt1( 0x29,0x18, "SIEMENS CSA HEADER" );
    gdcm::PrivateTag pt2( 0x29,0x34, "SIEMENS MEDCOM HEADER" );
    gdcm::PrivateTag pt3( 0x29,0x60, "SIEMENS MEDCOM HEADER2" );
    const char str1[] = "GDCM was here 3!";
    if( !ds.FindDataElement( pt1 ) ) return 1;
    gdcm::DataElement de1 = ds.GetDataElement( pt1 ); // Convert Private tag, into actual DataElement
    std::cout << de1 << std::endl;
    de1.SetByteValue( str1, (uint32_t)strlen(str1) );
    ds.Replace( de1 );
    const char str2[] = "GDCM was here 2!";
    if( !ds.FindDataElement( pt2 ) ) return 1;
    gdcm::DataElement de2 = ds.GetDataElement( pt2 );
    std::cout << de2 << std::endl;
    de2.SetByteValue( str2, (uint32_t)strlen(str2) );
    ds.Replace( de2 );
    const char str3[] = "GDCM was here 3!";
    if( !ds.FindDataElement( pt3 ) ) return 1;
    gdcm::DataElement de3 = ds.GetDataElement( pt3 );
    std::cout << de3 << std::endl;
    de3.SetByteValue( str3, (uint32_t)strlen(str3) );
    ds.Replace( de3 );
    gdcm::Writer writer;
    writer.SetFile( file );
    writer.SetFileName( outfile );
    if ( !writer.Write() )
    {
        return 1;
    }
    return 0;
}

```

## 12.37 ChangeSequenceUltrasound.cxx

```

/*=====
Program: GDCM (Grassroots DICOM). A DICOM library

Copyright (c) 2006-2011 Mathieu Malaterre
All rights reserved.
See Copyright.txt or http://gdcm.sourceforge.net/Copyright.html for details.

This software is distributed WITHOUT ANY WARRANTY; without even
the implied warranty of MERCHANTABILITY or FITNESS FOR A PARTICULAR
PURPOSE. See the above copyright notice for more information.

=====*/
#include "gdcmReader.h"
#include "gdcmWriter.h"
#include "gdcmSmartPointer.h"

```

```

#include "gdcmDataSetHelper.h"
/*
./ChangeSequenceUltrasound gdcmData/D_CLUNIE_CT1_J2KI.dcm myoutput.dcm

This is the exact C++ translation of the original python example: ManipulateSequence.py
*/
int main(int argc, char* argv[] )
{
    if( argc < 3 )
    {
        std::cerr << argv[0] << " input.dcm output.dcm" << std::endl;
        return 1;
    }
    const char *filename = argv[1];
    const char *outfilename = argv[2];
    gdcm::Reader reader;
    reader.SetFileName( filename );
    if (! reader.Read() )
    {
        return 1;
    }
    gdcm::File &file = reader.GetFile();
    gdcm::DataSet &ds = file.GetDataSet();
    gdcm::Tag tsis(0x0008,0x2112); // SourceImageSequence
    if ( ds.FindDataElement( tsis ) )
    {
        const gdcm::DataElement &sis = ds.GetDataElement( tsis );
        gdcm::SmartPointer<gdcm::SequenceOfItems> sqsis = sis.GetValueAsSQ();
        if ( sqsis && sqsis->GetNumberOfItems() )
        {
            gdcm::Item &item1 = sqsis->GetItem(1);
            gdcm::DataSet &nestedds = item1.GetNestedDataSet();
            gdcm::Tag tprcs(0x0040,0xa170); // PurposeOfReferenceCodeSequence
            if( nestedds.FindDataElement( tprcs ) )
            {
                const gdcm::DataElement &prcs = nestedds.GetDataElement( tprcs );
                gdcm::SmartPointer<gdcm::SequenceOfItems> sqprcs = prcs.GetValueAsSQ();
                if ( sqprcs && sqprcs->GetNumberOfItems() )
                {
                    gdcm::Item &item2 = sqprcs->GetItem(1);
                    gdcm::DataSet &nestedds2 = item2.GetNestedDataSet();
                    // (0008,0104) LO [Uncompressed predecessor] # 24, 1 CodeMeaning
                    gdcm::Tag tcm(0x0008,0x0104);
                    if( nestedds2.FindDataElement( tcm ) )
                    {
                        gdcm::DataElement cm = nestedds2.GetDataElement( tcm );
                        std::string mystr = "GDCM was here";
                        cm.SetByteValue( mystr.c_str(), (uint32_t)mystr.size() );
                        nestedds2.Replace( cm );
                    }
                }
            }
        }
    }
    gdcm::Writer writer;
    writer.SetFile( file );
    writer.SetFileName( outfile );
    if ( !writer.Write() )
    {
        return 1;
    }
    return 0;
}

```

## 12.38 CheckBigEndianBug.cxx

```

/*=====
Program: GDCM (Grassroots DICOM). A DICOM library

Copyright (c) 2006-2011 Mathieu Malaterre
All rights reserved.
See Copyright.txt or http://gdcm.sourceforge.net/Copyright.html for details.

This software is distributed WITHOUT ANY WARRANTY; without even
the implied warranty of MERCHANTABILITY or FITNESS FOR A PARTICULAR
PURPOSE. See the above copyright notice for more information.
=====

```

```

=====*/
/*
 * WARNING: This is a dev tool, do not use !
 *
 * Usage: after a gdcconv, you would like to know if the conversion process is acceptable
 * sometime a vbindiff is acceptable, sometime it is not. In the case of the famous Philips
 * Little/Big Endian Explicit Transfer Syntax it is not easy to compare two files. However
 * this only impact byte ordering, thus we can compute byte-independant information to still
 * compare the files.
 */
#include "gdcImageReader.h"
#include "gdcImage.h"
#include "gdcWriter.h"
#include "gdcAttribute.h"
#include "gdcSystem.h"
#include <iostream>
#include <fstream>
int main(int argc, char *argv[])
{
    if( argc < 3 )
    {
        std::cerr << argv[0] << " input1.dcm input2.dcm" << std::endl;
        return 1;
    }
    const char *filename1 = argv[1];
    const char *filename2 = argv[2];
    gdc::ImageReader reader1;
    reader1.SetFileName( filename1 );
    if( !reader1.Read() )
    {
        std::cerr << "Could not read: " << filename1 << std::endl;
        return 1;
    }
    gdc::ImageReader reader2;
    reader2.SetFileName( filename2 );
    if( !reader2.Read() )
    {
        std::cerr << "Could not read: " << filename2 << std::endl;
        return 1;
    }
    // TODO: need a DataSet== operator implementation
    std::cout << "Both files can be read and looks like DICOM" << std::endl;
    size_t s1 = gdc::System::FileSize(filename1);
    size_t s2 = gdc::System::FileSize(filename2);
    if( s1 != s2 )
    {
        std::cout << "Size mismatch: " << s1 << " != " << s2 << std::endl;
        return 1;
    }
    else
    {
        std::cout << "Size match: " << s1 << " = " << s2 << std::endl;
    }
    std::ifstream is1( filename1, std::ios::binary );
    char *buffer1 = new char[s1];
    is1.read(buffer1, s1);
    std::ifstream is2( filename2, std::ios::binary );
    char *buffer2 = new char[s2];
    is2.read(buffer2, s2);
    assert( s1 == s2 );
    if( memcmp(buffer1, buffer2, s1 ) == 0 )
    {
        std::cout << "memcmp succeed ! File are bit identical" << std::endl;
    }
    else
    {
        std::cout << "memcmp failed!" << std::endl;
    }
    // Hum...memcmp failed, for big endian/ little endian inversion the histogram of bytes
    // should still be the same. So let's compute it
    // buffer2[0] = 1; // let's make the test fail
    std::multiset<char> set1( buffer1, buffer1 + s1 );
    std::multiset<char> set2( buffer2, buffer2 + s2 );
    if( set1 == set2 )
    {
        std::cout << "set1 == set2. Byte histogram seems valid" << std::endl;
    }
    else
    {
        std::cout << "set1 != set2" << std::endl;
    }
}

```

```

    }
    delete[] buffer1;
    delete[] buffer2;
    return 0;
}

```

## 12.39 ClinicalTrialAnnotate.cxx

```

/*=====
Program: GDCM (Grassroots DICOM). A DICOM library

Copyright (c) 2006-2011 Mathieu Malaterre
All rights reserved.
See Copyright.txt or http://gdcm.sourceforge.net/Copyright.html for details.

This software is distributed WITHOUT ANY WARRANTY; without even
the implied warranty of MERCHANTABILITY or FITNESS FOR A PARTICULAR
PURPOSE. See the above copyright notice for more information.
=====*/
/*
 * Dummy implementation of C.7.1.3 Clinical Trial Subject Module
 *
 * Usage:
 * ClinicalTrialAnnotate gdcmData/012345.002.050.dcm out.dcm
 */
#include "gdcmReader.h"
#include "gdcmWriter.h"
#include "gdcmAnonymizer.h"
int main(int argc, char *argv[])
{
    if( argc < 3 )
    {
        std::cerr << argv[0] << " input.dcm output.dcm" << std::endl;
        return 1;
    }
    const char *filename = argv[1];
    const char *outfilename = argv[2];
    gdcm::Reader reader;
    reader.SetFileName( filename );
    if( !reader.Read() )
    {
        std::cerr << "Could not read: " << filename << std::endl;
        return 1;
    }
    // The output of gdcm::Reader is a gdcm::File
    //gdcm::File &file = reader.GetFile();
    // the dataset is the the set of element we are interested in:
    //gdcm::DataSet &ds = file.GetDataSet();
    gdcm::Anonymizer ano;
    ano.SetFile( reader.GetFile() );
    ano.RemoveGroupLength();
    ano.RemovePrivateTags();
    // PS 3.3 - 2008
    // C.7.1.3 Clinical Trial Subject Module
    // <entry group="0012" element="0010" vr="LO" vm="1" name="Clinical Trial Sponsor Name"/>
    ano.Replace( gdcm::Tag(0x12,0x10), "BigCompany name" );
    // <entry group="0012" element="0020" vr="LO" vm="1" name="Clinical Trial Protocol ID"/>
    ano.Replace( gdcm::Tag(0x12,0x20), "My Clinical Trial Protocol ID" );
    // <entry group="0012" element="0021" vr="LO" vm="1" name="Clinical Trial Protocol Name"/>
    ano.Replace( gdcm::Tag(0x12,0x21), "My Clinical Trial Protocol Name" );
    // <entry group="0012" element="0030" vr="LO" vm="1" name="Clinical Trial Site ID"/>
    ano.Replace( gdcm::Tag(0x12,0x30), "My Clinical Trial Site ID" );
    // <entry group="0012" element="0031" vr="LO" vm="1" name="Clinical Trial Site Name"/>
    ano.Replace( gdcm::Tag(0x12,0x31), "My Clinical Trial Site Name" );
    // <entry group="0012" element="0040" vr="LO" vm="1" name="Clinical Trial Subject ID"/>
    ano.Replace( gdcm::Tag(0x12,0x40), "My Clinical Trial Subject ID" );
    // <entry group="0012" element="0042" vr="LO" vm="1" name="Clinical Trial Subject Reading ID"/>
    ano.Replace( gdcm::Tag(0x12,0x42), "My Clinical Trial Subject Reading ID" );
    gdcm::Writer writer;
    writer.SetFile( reader.GetFile() );
    writer.SetFileName( outfilename );
    if( !writer.Write() )
    {
        return 1;
    }
}

```



```

    return 0;
}

```

## 12.40 CompressImage.cxx

```

/*=====
Program: GDCM (Grassroots DICOM). A DICOM library

Copyright (c) 2006-2011 Mathieu Malaterre
All rights reserved.
See Copyright.txt or http://gdcm.sourceforge.net/Copyright.html for details.

This software is distributed WITHOUT ANY WARRANTY; without even
the implied warranty of MERCHANTABILITY or FITNESS FOR A PARTICULAR
PURPOSE. See the above copyright notice for more information.

=====*/
/*
 *
 */
#include "gdcmImageReader.h"
#include "gdcmImage.h"
#include "gdcmWriter.h"
#include "gdcmAttribute.h"
#include "gdcmImageWriter.h"
#include "gdcmImageChangeTransferSyntax.h"
#include <iostream>
#include <fstream>
int main(int argc, char *argv[])
{
    if( argc < 3 )
    {
        std::cerr << argv[0] << " input.dcm output.dcm" << std::endl;
        return 1;
    }
    const char *filename = argv[1];
    const char *outfilename = argv[2];
    gdcm::ImageReader reader;
    reader.SetFileName( filename );
    if( !reader.Read() )
    {
        std::cerr << "Could not read: " << filename << std::endl;
        return 1;
    }
    // The output of gdcm::Reader is a gdcm::File
    //gdcm::File &file = reader.GetFile();
    // the dataset is the the set of element we are interested in:
    //gdcm::DataSet &ds = file.GetDataSet();
    gdcm::Image &image = reader.GetImage();
    // image.SetSpacing(0, 0.1);
    // image.SetSpacing(1, 0.2);
    image.Print( std::cout );
    gdcm::ImageChangeTransferSyntax change;
    change.SetTransferSyntax( gdcm::TransferSyntax::JPEG2000Lossless );
    change.SetTransferSyntax( gdcm::TransferSyntax::JPEGLosslessProcess14_1 );
    //change.SetTransferSyntax( gdcm::TransferSyntax::JPEGBaselineProcess1 );
    //change.SetTransferSyntax( image.GetTransferSyntax() );
    change.SetInput( image );
    bool b = change.Change();
    if( !b )
    {
        std::cerr << "Could not change the Transfer Syntax" << std::endl;
        return 1;
    }
    //std::ofstream out( outfile, std::ios::binary );
    //image.GetBuffer2(out);
    //out.close();
    gdcm::ImageWriter writer;
    writer.SetImage( change.GetOutput() );
    writer.SetFile( reader.GetFile() );
    writer.SetFileName( outfile );
    if( !writer.Write() )
    {
        return 1;
    }
    return 0;
}

```

## 12.41 ConvertToQImage.cxx

```

/*=====
Program: GDCM (Grassroots DICOM). A DICOM library

Copyright (c) 2006-2011 Mathieu Malaterre
All rights reserved.
See Copyright.txt or http://gdcm.sourceforge.net/Copyright.html for details.

This software is distributed WITHOUT ANY WARRANTY; without even
the implied warranty of MERCHANTABILITY or FITNESS FOR A PARTICULAR
PURPOSE. See the above copyright notice for more information.
=====*/
/*
 * This example shows how to setup the pipeline from a gdcm::ImageReader into a
 * Qt QImage data structure.
 * It only handles 2D image.
 *
 * Ref:
 * http://doc.trolltech.com/4.5/qimage.html
 *
 * Usage:
 * ConvertToQImage gdcmData/012345.002.050.dcm output.png

 * Thanks:
 * Sylvain ADAM (sylvain51 hotmail com) for contributing this example
 */
#include "gdcmImageReader.h"
#include <QImage>
#include <QImageWriter>
bool ConvertToFormat_RGB888(gdcm::Image const & gimage, char *buffer, QImage* &imageQt)
{
    const unsigned int* dimension = gimage.GetDimensions();
    unsigned int dimX = dimension[0];
    unsigned int dimY = dimension[1];
    gimage.GetBuffer(buffer);
    // Let's start with the easy case:
    if( gimage.GetPhotometricInterpretation() == gdcm::PhotometricInterpretation::RGB )
    {
        if( gimage.GetPixelFormat() != gdcm::PixelFormat::UINT8 )
        {
            return false;
        }
        unsigned char *ubuffer = (unsigned char*)buffer;
        // QImage::Format_RGB888 13 The image is stored using a 24-bit RGB format (8-8-8).
        imageQt = new QImage((unsigned char *)ubuffer, dimX, dimY, 3*dimX, QImage::Format_RGB888);
    }
    else if( gimage.GetPhotometricInterpretation() == gdcm::PhotometricInterpretation::MONOCHROME2 )
    {
        if( gimage.GetPixelFormat() == gdcm::PixelFormat::UINT8 )
        {
            // We need to copy each individual 8bits into R / G and B:
            unsigned char *ubuffer = new unsigned char[dimX*dimY*3];
            unsigned char *pubuffer = ubuffer;
            for(unsigned int i = 0; i < dimX*dimY; i++)
            {
                *pubuffer++ = *buffer;
                *pubuffer++ = *buffer;
                *pubuffer++ = *buffer++;
            }
            imageQt = new QImage(ubuffer, dimX, dimY, QImage::Format_RGB888);
        }
    }
    else if( gimage.GetPixelFormat() == gdcm::PixelFormat::INT16 )
    {
        // We need to copy each individual 16bits into R / G and B (truncate value)
        short *buffer16 = (short*)buffer;
        unsigned char *ubuffer = new unsigned char[dimX*dimY*3];
        unsigned char *pubuffer = ubuffer;
        for(unsigned int i = 0; i < dimX*dimY; i++)
        {
            // Scalar Range of gdcmData/012345.002.050.dcm is [0,192], we could simply do:
            // *pubuffer++ = *buffer16;
            // *pubuffer++ = *buffer16;
            // *pubuffer++ = *buffer16;
            // instead do it right:
            *pubuffer++ = (unsigned char)std::min(255, (32768 + *buffer16) / 255);
            *pubuffer++ = (unsigned char)std::min(255, (32768 + *buffer16) / 255);
            *pubuffer++ = (unsigned char)std::min(255, (32768 + *buffer16) / 255);
        }
    }
}

```

```

        buffer16++;
    }
    QImageQt = new QImage(ubuffer, dimX, dimY, QImage::Format_RGB888);
}
else
{
    std::cerr << "Pixel Format is: " << gimage.GetPixelFormat() << std::endl;
    return false;
}
}
else
{
    std::cerr << "Unhandled PhotometricInterpretation: " << gimage.GetPhotometricInterpretation() << std::endl;
    return false;
}
return true;
}
int main(int argc, char *argv[])
{
    if( argc < 2 )
    {
        return 1;
    }
    const char *filename = argv[1];
    const char *outfilename = argv[2];
    gdcm::ImageReader ir;
    ir.SetFileName( filename );
    if(!ir.Read())
    {
        //Read failed
        return 1;
    }
    std::cout<<"Getting image from ImageReader..."<<std::endl;
    const gdcm::Image &gimage = ir.GetImage();
    std::vector<char> vbuffer;
    vbuffer.resize( gimage.GetBufferLength() );
    char *buffer = &vbuffer[0];
    QImage *imageQt = NULL;
    if( !ConvertToFormat_RGB888( gimage, buffer, imageQt ) )
    {
        return 1;
    }
    QImageWriter writer;
    writer.setFormat("png");
    writer.setFileName( outfile );
    if( !writer.write( *imageQt ) )
    {
        return 1;
    }
    return 0;
}

```

## 12.42 CreateARGBImage.cxx

```

/*=====
Program: GDCM (Grassroots DICOM). A DICOM library

Copyright (c) 2006-2011 Mathieu Malaterre
All rights reserved.
See Copyright.txt or http://gdcm.sourceforge.net/Copyright.html for details.

This software is distributed WITHOUT ANY WARRANTY; without even
the implied warranty of MERCHANTABILITY or FITNESS FOR A PARTICULAR
PURPOSE. See the above copyright notice for more information.

=====*/
/*
 * http://www.w3.org/Graphics/PNG/inline-alpha.html
 * alphatest.png: PNG image data, 380 x 287, 8-bit/color RGBA, non-interlaced
 *
 * $ convert alphatest.png alphatest.rgba
 */
#include "gdcmImageReader.h"
#include "gdcmSequenceOfFragments.h"
#include "gdcmSystem.h"
#include "gdcmImageWriter.h"

```

```

#include <iostream>
#include <fstream>
int main(int argc, char *argv[])
{
    if( argc < 3 )
    {
        std::cerr << argv[0] << " input.rgba output.dcm" << std::endl;
        return 1;
    }
    const char *filename = argv[1];
    const char *outfilename = argv[2];
    size_t len = gdcm::System::FileSize(filename);
    std::ifstream is(filename, std::ios::binary);
    char * buf = new char[len];
    is.read(buf, len);
    gdcm::ImageWriter writer;
    gdcm::Image &image = writer.GetImage();
    image.SetNumberOfDimensions( 2 );
    unsigned int dims[3] = {};
    dims[0] = 380;
    dims[1] = 287;
    image.SetDimensions( dims );
    gdcm::PixelFormat pf = gdcm::PixelFormat::UINT8;
    pf.SetSamplesPerPixel( 4 );
    image.SetPixelFormat( pf );
    gdcm::PhotometricInterpretation pi = gdcm::PhotometricInterpretation::ARGB;
    image.SetPhotometricInterpretation( pi );
    image.SetTransferSyntax( gdcm::TransferSyntax::ExplicitVRLittleEndian );
    gdcm::DataElement pixeldata( gdcm::Tag(0x7fe0,0x0010) );
    pixeldata.SetByteValue( buf, (uint32_t)len );
    image.SetDataElement( pixeldata );
    writer.SetFileName( outfile );
    if( !writer.Write() )
    {
        return 1;
    }
    delete[] buf;
    return 0;
}

```

## 12.43 CreateCMYKImage.cxx

```

/*=====
Program: GDCM (Grassroots DICOM). A DICOM library

Copyright (c) 2006-2011 Mathieu Malaterre
All rights reserved.
See Copyright.txt or http://gdcm.sourceforge.net/Copyright.html for details.

This software is distributed WITHOUT ANY WARRANTY; without even
the implied warranty of MERCHANTABILITY or FITNESS FOR A PARTICULAR
PURPOSE. See the above copyright notice for more information.

=====*/
/*
 * http://www.w3.org/Graphics/PNG/inline-alpha.html
 * alphatest.png: PNG image data, 380 x 287, 8-bit/color RGBA, non-interlaced
 *
 * $ convert alphatest.png alphatest.cmyk
 */
#include "gdcmImageReader.h"
#include "gdcmSequenceOfFragments.h"
#include "gdcmSystem.h"
#include "gdcmImageWriter.h"
#include <iostream>
#include <fstream>
int main(int argc, char *argv[])
{
    if( argc < 3 )
    {
        std::cerr << argv[0] << " input.cmyk output.dcm" << std::endl;
        return 1;
    }
    const char *filename = argv[1];
    const char *outfilename = argv[2];
    size_t len = gdcm::System::FileSize(filename);

```

```

std::ifstream is(filename, std::ios::binary);
char * buf = new char[len];
is.read(buf, len);
gdcm::ImageWriter writer;
gdcm::Image &image = writer.GetImage();
image.SetNumberOfDimensions( 2 );
unsigned int dims[3] = {};
dims[0] = 380;
dims[1] = 287;
image.SetDimensions( dims );
gdcm::PixelFormat pf = gdcm::PixelFormat::UINT8;
pf.SetSamplesPerPixel( 4 );
image.SetPixelFormat( pf );
gdcm::PhotometricInterpretation pi = gdcm::PhotometricInterpretation::CMYK;
image.SetPhotometricInterpretation( pi );
image.SetTransferSyntax( gdcm::TransferSyntax::ExplicitVRLittleEndian );
gdcm::DataElement pixeldata( gdcm::Tag(0x7fe0,0x0010) );
pixeldata.SetByteValue( buf, (uint32_t)len );
image.SetDataElement( pixeldata );
writer.SetFileName( outfile );
if( !writer.Write() )
{
    return 1;
}
delete[] buf;
return 0;
}

```

## 12.44 CreateJPIPDataSet.cxx

```

/*=====
Program: GDICOM (Grassroots DICOM). A DICOM library

Copyright (c) 2006-2011 Mathieu Malaterre
All rights reserved.
See Copyright.txt or http://gdcm.sourceforge.net/Copyright.html for details.

This software is distributed WITHOUT ANY WARRANTY; without even
the implied warranty of MERCHANTABILITY or FITNESS FOR A PARTICULAR
PURPOSE. See the above copyright notice for more information.

=====*/
/*
 * This example was created during the GSOC 2011 project for
 * JPIP
 */
#include "gdcmAnonymizer.h"
#include "gdcmWriter.h"
#include "gdcmUIDGenerator.h"
#include "gdcmFile.h"
#include "gdcmTag.h"
#include "gdcmSystem.h"
#include "gdcmAttribute.h"
int main(int argc, char *argv[])
{
    if( argc < 2 )
    {
        std::cerr << argv[0] << " output.dcm" << std::endl;
        return 1;
    }
    const char *outfile = argv[1];
    gdcm::Writer w;
    gdcm::File &file = w.GetFile();
    gdcm::DataSet &ds = file.GetDataSet();
    //w.SetCheckFileMetaInformation( true );
    w.SetFileName( outfile );
    file.GetHeader().SetDataSetTransferSyntax( gdcm::TransferSyntax::JPIPReferenced );
    gdcm::Anonymizer anon;
    anon.SetFile( file );
    gdcm::MediaStorage ms = gdcm::MediaStorage::SecondaryCaptureImageStorage;
    gdcm::UIDGenerator gen;
    anon.Replace( gdcm::Tag(0x0008,0x16), ms.GetString() );
    std::cout << ms.GetString() << std::endl;
    anon.Replace( gdcm::Tag(0x0008,0x18), gen.Generate() );
    //
    anon.Replace( gdcm::Tag(0x0010,0x10), "JPIP^EXAMPLE" );
}

```

```

anon.Replace( gdcM::Tag(0x0010,0x20), "012345" );
anon.Empty( gdcM::Tag(0x0010,0x30) );
anon.Empty( gdcM::Tag(0x0010,0x40) );
anon.Empty( gdcM::Tag(0x0008,0x20) );
anon.Empty( gdcM::Tag(0x0008,0x30) );
anon.Empty( gdcM::Tag(0x0008,0x90) );
anon.Empty( gdcM::Tag(0x0020,0x10) );
anon.Empty( gdcM::Tag(0x0020,0x11) );
anon.Empty( gdcM::Tag(0x0008,0x50) );
anon.Empty( gdcM::Tag(0x0020,0x0013) );
anon.Replace( gdcM::Tag(0x0020,0xd), gen.Generate() );
anon.Replace( gdcM::Tag(0x0020,0xe), gen.Generate() );
anon.Replace( gdcM::Tag(0x0008,0x64), "WSD " );
anon.Replace( gdcM::Tag(0x0008,0x60), "OT" );
gdcM::Attribute<0x0028,0x7FE0> at;
at.SetValue( "http://dicom.example.com/jpipserver.cgi?target=img.jp2" );
ds.Insert( at.GetDataElement() );
// Need to retrieve the PixelFormat information from the given file
if ( !w.Write() )
{
    std::cerr << "Could not write: " << outfilename << std::endl;
    return 1;
}
return 0;
}

```

## 12.45 DeriveSeries.cxx

```

/*=====
Program: GDCM (Grassroots DICOM). A DICOM library

Copyright (c) 2006-2011 Mathieu Malaterre
All rights reserved.
See Copyright.txt or http://gdcM.sourceforge.net/Copyright.html for details.

This software is distributed WITHOUT ANY WARRANTY; without even
the implied warranty of MERCHANTABILITY or FITNESS FOR A PARTICULAR
PURPOSE. See the above copyright notice for more information.

=====*/
#include "gdcMReader.h"
#include "gdcMWriter.h"
#include "gdcMAttribute.h"
#include "gdcMFileDerivation.h"
#include "gdcMUIDGenerator.h"
int main(int argc, char *argv[])
{
    if( argc < 3 )
    {
        return 1;
    }
    const char * ref = argv[1];
    const char * in = argv[2];
    gdcM::Reader r1;
    r1.SetFileName( ref );
    if( !r1.Read() ) return 1;
    gdcM::Reader r2;
    r2.SetFileName( in );
    if( !r2.Read() ) return 1;
    // Fix Spatial info:
    gdcM::DataSet & ds1 = r1.GetFile().GetDataSet();
    gdcM::File & file2 = r2.GetFile();
    gdcM::DataSet & ds2 = file2.GetDataSet();
    //gdcM::Attribute<0x8,0x8> img_type = { "ORIGINAL", "PRIMARY" };
    ds2.Replace( ds1.GetDataElement( gdcM::Tag(0x0008,0x0008) ) );
    ds2.Replace( ds1.GetDataElement( gdcM::Tag(0x0020,0x0032) ) );
    ds2.Replace( ds1.GetDataElement( gdcM::Tag(0x0020,0x0037) ) );
    ds2.Replace( ds1.GetDataElement( gdcM::Tag(0x0018,0x0088) ) ); // Spacing between slices
    ds2.Replace( ds1.GetDataElement( gdcM::Tag(0x0020,0x0013) ) ); // Instance Number
    ds2.Replace( ds1.GetDataElement( gdcM::Tag(0x0018,0x5100) ) ); // Patient Position
    ds2.Replace( ds1.GetDataElement( gdcM::Tag(0x0018,0x0050) ) ); // Slice Thickness
    ds2.Replace( ds1.GetDataElement( gdcM::Tag(0x0008,0x0070) ) ); // Manufacturer
    ds2.Replace( ds1.GetDataElement( gdcM::Tag(0x0018,0x0081) ) ); // Echo Time
    ds2.Replace( ds1.GetDataElement( gdcM::Tag(0x0020,0x1041) ) ); // Slice Location
    gdcM::Attribute<0x8,0x16> sopclassuid;
    sopclassuid.SetFromDataSet( ds1 );
}

```

```

gdcM::Attribute<0x8,0x18> sopinstanceuid;
sopinstanceuid.SetFromDataSet( ds1 );
// Step 2: DERIVED object
gdcM::FileDerivation fd;
fd.AddReference( sopclassuid.GetValue(), sopinstanceuid.GetValue() );
// http://dicom.nema.org/MEDICAL/dicom/current/output/chtml/part16/chapter_D.html#DCM_121321
// CID 7202 "Source Image Purposes of Reference"
// DCM 121321 "Mask image for image processing operation"
fd.SetPurposeOfReferenceCodeSequenceCodeValue( 121321 );
// CID 7203 "Image Derivation"
// DCM 113047 "Pixel by pixel mask"
fd.SetDerivationCodeSequenceCodeValue( 113047 );
fd.SetFile( file2 );
// If all Code Value are ok the filter will execute properly
if( !fd.Derive() )
{
    std::cerr << "Sorry could not derive using input info" << std::endl;
    return 1;
}
gdcM::Writer w;
w.SetFile( r2.GetFile() );
w.SetFileName( "derived.dcm" );
if( !w.Write() )
{
    return 1;
}
return 0;
}

```

## 12.46 DiffFile.cxx

```

/*=====
Program: GDCM (Grassroots DICOM). A DICOM library

Copyright (c) 2006-2011 Mathieu Malaterre
All rights reserved.
See Copyright.txt or http://gdcM.sourceforge.net/Copyright.html for details.

This software is distributed WITHOUT ANY WARRANTY; without even
the implied warranty of MERCHANTABILITY or FITNESS FOR A PARTICULAR
PURPOSE. See the above copyright notice for more information.

=====*/
#include "gdcMReader.h"
int main(int argc, char *argv[])
{
    if( argc < 3 )
    {
        std::cerr << argv[0] << " input1.dcm input2.dcm" << std::endl;
        return 1;
    }
    const char *filename1 = argv[1];
    const char *filename2 = argv[2];
    gdcM::Reader reader1;
    reader1.SetFileName( filename1 );
    if( !reader1.Read() )
    {
        return 1;
    }
    gdcM::Reader reader2;
    reader2.SetFileName( filename2 );
    if( !reader2.Read() )
    {
        return 1;
    }
    const gdcM::File &file1 = reader1.GetFile();
    const gdcM::File &file2 = reader2.GetFile();
    const gdcM::DataSet &ds1 = file1.GetDataSet();
    const gdcM::DataSet &ds2 = file2.GetDataSet();
    gdcM::DataSet::ConstIterator it1 = ds1.Begin();
    gdcM::DataSet::ConstIterator it2 = ds2.Begin();
    const gdcM::DataElement &de1 = *it1;
    const gdcM::DataElement &de2 = *it2;
    if( de1 == de2 )
    {
    }
}

```

```

while( it1 != ds1.End() && it2 != ds2.End() && *it1 == *it2 )
{
    ++it1;
    ++it2;
}
if( it1 != ds1.End() || it2 != ds2.End() )
{
    std::cerr << "Problem with:" << std::endl;
    if( it1 != ds1.End() )
    {
        std::cerr << "ds1: " << *it1 << std::endl;
    }
    if( it2 != ds2.End() )
    {
        std::cerr << "ds2: " << *it2 << std::endl;
    }
    return 1;
}
return 0;
}

```

## 12.47 DiscriminateVolume.cxx

```

/*=====
Program: GDCM (Grassroots DICOM). A DICOM library

Copyright (c) 2006-2011 Mathieu Malaterre
All rights reserved.
See Copyright.txt or http://gdcm.sourceforge.net/Copyright.html for details.

This software is distributed WITHOUT ANY WARRANTY; without even
the implied warranty of MERCHANTABILITY or FITNESS FOR A PARTICULAR
PURPOSE. See the above copyright notice for more information.

=====*/
#include "gdcmScanner.h"
#include "gdcmTesting.h"
#include "gdcmIPPSorter.h"
#include "gdcmDirectionCosines.h"
#include <cmath>
/*
 * The following example is a basic sorted which should work in generic cases.
 * It sort files based on:
 * Study Instance UID
 * Series Instance UID
 * Frame of Reference UID
 * Image Orientation (Patient)
 * Image Position (Patient) (Sorting based on IPP + IOP)
 */
namespace gdcm {
    const Tag t1(0x0020,0x000d); // Study Instance UID
    const Tag t2(0x0020,0x000e); // Series Instance UID
    const Tag t3(0x0020,0x0052); // Frame of Reference UID
    const Tag t4(0x0020,0x0037); // Image Orientation (Patient)
class DiscriminateVolume
{
private:
    std::vector< Directory::FileNamesType > SortedFiles;
    std::vector< Directory::FileNamesType > UnsortedFiles;
    Directory::FileNamesType GetAllFileNamesFromTagToValue(
        Scanner const & s, Directory::FileNamesType const &filesubset, Tag const &t, const char *valueref)
{
    Directory::FileNamesType theReturn;
    if( valueref )
    {
        size_t len = strlen( valueref );
        Directory::FileNamesType::const_iterator file = filesubset.begin();
        for(; file != filesubset.end(); ++file)
        {
            const char *filename = file->c_str();
            const char * value = s.GetValue(filename, t);
            if( value && strncmp(value, valueref, len) == 0 )
            {
                theReturn.push_back( filename );
            }
        }
    }
}
}

```



```

    }
    return theReturn;
}
void ProcessAIOP(Scanner const & , Directory::FileNamesType const & subset, const char *iopval)
{
    std::cout << "IOP: " << iopval << std::endl;
    IPPSorter ipp;
    ipp.SetComputeZSpacing( true );
    ipp.SetZSpacingTolerance( 1e-3 ); // ??
    bool b = ipp.Sort( subset );
    if( !b )
    {
        // If you reach here this means you need one more parameter to discriminiat this
        // series. Eg. T1 / T2 intertwined. Multiple Echo (0018,0081)
        std::cerr << "Failed to sort: " << subset.begin()->c_str() << std::endl;
        for(
            Directory::FileNamesType::const_iterator file = subset.begin();
            file != subset.end(); ++file)
        {
            std::cerr << *file << std::endl;
        }
        UnsortedFiles.push_back( subset );
        return ;
    }
    ipp.Print( std::cout );
    SortedFiles.push_back( ipp.GetFilesNames() );
}
void ProcessAFrameOfRef(Scanner const & s, Directory::FileNamesType const & subset, const char * frameuid)
{
    // In this subset of files (belonging to same series), let's find those
    // belonging to the same Frame ref UID:
    Directory::FileNamesType files = GetAllFileNamesFromTagToValue(
        s, subset, t3, frameuid);
    std::set< std::string > iopset;
    for(
        Directory::FileNamesType::const_iterator file = files.begin();
        file != files.end(); ++file)
    {
        //std::cout << *file << std::endl;
        const char * value = s.GetValue(file->c_str(), gdcm::t4 );
        assert( value );
        iopset.insert( value );
    }
    size_t n = iopset.size();
    if ( n == 0 )
    {
        assert( files.empty() );
        return;
    }
    std::cout << "Frame of Ref: " << frameuid << std::endl;
    if ( n == 1 )
    {
        ProcessAIOP(s, files, iopset.begin()->c_str() );
    }
    else
    {
        const char *f = files.begin()->c_str();
        std::cerr << "More than one IOP: " << f << std::endl;
        // Make sure that there is actually 'n' different IOP
        gdcm::DirectionCosines ref;
        gdcm::DirectionCosines dc;
        for(
            std::set< std::string >::const_iterator it = iopset.begin();
            it != iopset.end(); ++it )
        {
            ref.SetFromString( it->c_str() );
            for(
                Directory::FileNamesType::const_iterator file = files.begin();
                file != files.end(); ++file)
            {
                std::string value = s.GetValue(file->c_str(), gdcm::t4 );
                if( value != it->c_str() )
                {
                    dc.SetFromString( value.c_str() );
                    const double crossdot = ref.CrossDot(dc);
                    const double eps = std::fabs( 1. - crossdot );
                    if( eps < 1e-6 )
                    {
                        std::cerr << "Problem with IOP discrimination: " << file->c_str()
                            << " " << it->c_str() << std::endl;
                        return;
                    }
                }
            }
        }
    }
}

```

```

        }
    }
}
// If we reach here this means there is actually 'n' different IOP
for(
std::set< std::string >::const_iterator it = iopset.begin();
it != iopset.end(); ++it )
{
    const char *iopvalue = it->c_str();
    Directory::FileNamesType iopfiles = GetAllFileNamesFromTagToValue(
        s, files, t4, iopvalue );
    ProcessAIOP(s, iopfiles, iopvalue );
}
}
}
void ProcessASeries(Scanner const & s, const char * seriesuid)
{
    std::cout << "Series: " << seriesuid << std::endl;
    // let's find all files belonging to this series:
    Directory::FileNamesType seriesfiles = GetAllFileNamesFromTagToValue(
        s, s.GetFilesNames(), t2, seriesuid);
    gdcms::Scanner::ValueType vt3 = s.GetValues(t3);
    for(
        gdcms::Scanner::ValueType::const_iterator it = vt3.begin()
        ; it != vt3.end(); ++it )
        {
            ProcessAFrameOfRef(s, seriesfiles, it->c_str());
        }
}
void ProcessAStudy(Scanner const & s, const char * studyuid)
{
    std::cout << "Study: " << studyuid << std::endl;
    gdcms::Scanner::ValueType vt2 = s.GetValues(t2);
    for(
        gdcms::Scanner::ValueType::const_iterator it = vt2.begin()
        ; it != vt2.end(); ++it )
        {
            ProcessASeries(s, it->c_str());
        }
}
public:
void Print( std::ostream & os )
{
    os << "Sorted Files: " << std::endl;
    for(
        std::vector< Directory::FileNamesType >::const_iterator it = SortedFiles.begin();
        it != SortedFiles.end(); ++it )
        {
            os << "Group: " << std::endl;
            for(
                Directory::FileNamesType::const_iterator file = it->begin();
                file != it->end(); ++file)
                {
                    os << *file << std::endl;
                }
        }
    os << "Unsorted Files: " << std::endl;
    for(
        std::vector< Directory::FileNamesType >::const_iterator it = UnsortedFiles.begin();
        it != UnsortedFiles.end(); ++it )
        {
            os << "Group: " << std::endl;
            for(
                Directory::FileNamesType::const_iterator file = it->begin();
                file != it->end(); ++file)
                {
                    os << *file << std::endl;
                }
        }
}
std::vector< Directory::FileNamesType > const & GetSortedFiles() const { return SortedFiles; }
std::vector< Directory::FileNamesType > const & GetUnsortedFiles() const { return UnsortedFiles; }
void ProcessIntoVolume( Scanner const & s )
{
    gdcms::Scanner::ValueType vt1 = s.GetValues( gdcms::t1 );
    for(
        gdcms::Scanner::ValueType::const_iterator it = vt1.begin()
        ; it != vt1.end(); ++it )
        {
            ProcessAStudy( s, it->c_str() );
        }
}

```

```

    }
};
} // namespace gdcm
int main(int argc, char *argv[])
{
    std::string dir1;
    if( argc < 2 )
    {
        const char *extradataroot = nullptr;
#ifdef GDCM_BUILD_TESTING
        extradataroot = gdcm::Testing::GetDataExtraRoot();
#endif
        if( !extradataroot )
        {
            return 1;
        }
        dir1 = extradataroot;
        dir1 += "/gdcmSampleData/ForSeriesTesting/VariousIncidences/ST1";
    }
    else
    {
        dir1 = argv[1];
    }
    gdcm::Directory d;
    d.Load( dir1.c_str(), true ); // recursive !
    gdcm::Scanner s;
    s.AddTag( gdcm::t1 );
    s.AddTag( gdcm::t2 );
    s.AddTag( gdcm::t3 );
    s.AddTag( gdcm::t4 );
    bool b = s.Scan( d.GetFilesNames() );
    if( !b )
    {
        std::cerr << "Scanner failed" << std::endl;
        return 1;
    }
    gdcm::DiscriminateVolume dv;
    dv.ProcessIntoVolume( s );
    dv.Print( std::cout );
    return 0;
}

```

## 12.48 DumpADAC.cxx

```

/*=====
Program: GDCM (Grassroots DICOM). A DICOM library

Copyright (c) 2006-2011 Mathieu Malaterre
All rights reserved.
See Copyright.txt or http://gdcm.sourceforge.net/Copyright.html for details.

This software is distributed WITHOUT ANY WARRANTY; without even
the implied warranty of MERCHANTABILITY or FITNESS FOR A PARTICULAR
PURPOSE. See the above copyright notice for more information.

=====*/
/*
 * the goal of this example is to mimic the behavior of disp_img_header
 * see http://www.gmecorp-usa.com/IM/NM/GC/ADAC/SV/adactechtips/Released_01Q3.pdf
 */
#include "gdcmReader.h"
#include "gdcmPrivateTag.h"
#include "gdcmAttribute.h"
#include "gdcmImageWriter.h"
#include <iostream>
#include <fstream>
#include <vector>
#include <string.h>
#include <assert.h>
#include <stdint.h>
struct dict
{
    uint16_t key;
    const char *name;
};

```

```

dict Array[] = {
  { 0x01, "Patient name" },
  { 0x02, "Patient ID" },
  { 0x03, "Patient sex" },
  { 0x04, "Patient age" },
  { 0x05, "Patient height" },
  { 0x06, "Patient weight" },
  { 0x07, "Exam date" },
  { 0x08, "Dose admin. time" },
  { 0x09, "Unique exam key" },
  { 0x0a, "Exam procedure" },
  { 0x0b, "Referring physician" },
  { 0x0c, "Attending physician" },
  { 0x0d, "Imaging modality" },
  { 0x0e, "Hospital ID" },
  { 0x0f, "Histogram crv file" },
  { 0x10, "Acq. start time" },
  { 0x11, "Object data type" },
  { 0x12, "Image viewid" },
  { 0x13, "Imaging device name" },
  { 0x14, "Device serial number" },
  { 0x15, "Collimator" },
  { 0x16, "Software version" },
  { 0x17, "Radiopharmaceutical #1" },
  { 0x18, "Energy window #1 center" },
  { 0x19, "Radiopharmaceutical #2" },
  { 0x1a, "Energy window #1 width" },
  { 0x1b, "Isotope imaging mode" },
  { 0x1c, "Energy window #2 center" },
  { 0x1d, "Energy window #2 width" },
  { 0x1e, "Energy window #3 center" },
  { 0x1f, "Energy window #3 width" },
  { 0x20, "Energy window #4 center" },
  { 0x21, "Energy window #4 width" },
  { 0x22, "??Energy window #5 center" },
  { 0x23, "??Energy window #5 width" },
  { 0x24, "Patient orientation" },
  { 0x25, "Spatial resolution" },
  { 0x26, "Slice thickness" },
  { 0x27, "Image X dimension" },
  { 0x28, "Image Y dimension" },
  { 0x29, "Image Z dimension" },
  { 0x2a, "Image pixel width" },
  { 0x2b, "Uniformity corr. file" },
  { 0x2c, "Acquisition zoom factor" },
  { 0x2d, "Total counts in set" },
  { 0x2e, "Time / frame" },
  { 0x2f, "Total acq. time" },
  { 0x30, "Maximum pixel value" },
  { 0x31, "Minimum pixel value" },
  { 0x32, "R-R interval time" },
  { 0x33, "Percent of cycle imaged" },
  { 0x34, "# of cycles accepted" },
  { 0x35, "# of cycles rejected" },
  { 0x36, "Approximate ED frame" },
  { 0x37, "Approximate ES frame" },
  { 0x38, "Approximate EF" },
  { 0x39, "Starting angle" },
  { 0x3a, "Degrees of rotation" },
  { 0x3b, "Direction of rotation" },
  { 0x3c, "Cont. or step/shoot" },
  { 0x3d, "Lim recon start frame" },
  { 0x3e, "Upper window grey shade" },
  { 0x3f, "Lower lvl grey shade" },
  { 0x40, "Associated color map" },
  { 0x41, "Custom color map file" },
  { 0x42, "Manipulated image" },
  { 0x43, "Axis of rotation corr." },
  { 0x44, "Reorientation azimuth" },
  { 0x45, "Reorientation elevation" },
  { 0x46, "Filter type" },
  { 0x47, "Filter order" },
  { 0x48, "Filter cutoff frequency" },
  { 0x49, "Reconstruction type" },
  { 0x4a, "Attenuation coefficient" },
  { 0x4b, "Associated parent file" },
  { 0x4c, "Unique patient key" },
  { 0x52, "Normalization crv file" },
  { 0x53, "Unique object key" },
  { 0x54, "This phase of VFR is" },
  { 0x55, "True color value" },

```

```

    { 0x56, "# of sets of x,y,z grps" },
    { 0x57, "Scale factor of set" },
    { 0x6d, "Date of birth" },
    { 0x6e, "Directional orientation" },
    { 0x6f, "Number of VFR studies" },
    { 0x70, "R-R low tolerance" },
    { 0x71, "R-R high tolerance" },
    { 0x72, "Prog specific results:" },
    { 0x99, nullptr }
};
void printname( int , int , uint16_t v )
{
    if( v == 0x1 )
    {
        std::cout << "DATABASE PARAMETERS" << std::endl;
        std::cout << "_____" << std::endl;
    }
    else if( v == 0x27 )
    {
        std::cout << "IMAGE PARAMETERS" << std::endl;
        std::cout << "_____" << std::endl;
    }
    else if( v == 0x13 )
    {
        std::cout << "EXTRA PARAMETERS" << std::endl;
        std::cout << "_____" << std::endl;
    }
    else if( v == 0x2e )
    {
        std::cout << "*** NOT CURRENTLY USED :" << std::endl;
    }
    static const unsigned int n = sizeof( Array ) / sizeof( *Array ) - 1;
    for( unsigned int i = 0; i < n; ++i )
    {
        if( v == Array[i].key )
        {
            std::cout << /*" << std::dec << len << ", " << mult << " " << */ Array[i].name;
            std::cout << " : ";
            return;
        }
    }
    std::cout << /*"\t# " << std::dec << len << ", " << mult << */ std::hex << v << "\t: ";
}
uint16_t readint16(std::istream &is )
{
    uint16_t val;
    is.read( (char*)&val, sizeof( val ));
    return (uint16_t)((val>8) | (val<8));
}
uint32_t readint32(std::istream &is )
{
    uint32_t val;
    is.read( (char*)&val, sizeof( val ));
    val= ((val<8)&0xFF00FF00) | ((val>8)&0x00FF00FF);
    return (val>16) | (val<16);
}
float readfloat32(std::istream &is )
{
    union { uint32_t val; float f;} dual;
    dual.val = readint32(is);
    return dual.f;
}
struct el
{
    uint16_t v1;
    uint16_t v2;
    uint16_t v3;
    void read( std::istream & is )
    {
        v1 = readint16(is);
        v2 = readint16(is);
        v3 = readint16(is);
    }
    void print( std::ostream & os )
    {
        os << std::hex << v1 << "\t" << v2 << "\t" << v3 << std::endl;
    }
};
std::vector<el> Vel;
void readelement( std::istream & is )
{

```

```

    e;
    e.read( is );
    Vel.push_back( e );
}
void printascii( uint16_t tag, const char *buffer, size_t len )
{
    std::ostream & os = std::cout;
    if( tag == 0x72 )
    {
        os << "\n ";
        for( size_t i = 0; i < len; ++i )
        {
            const char &c = buffer[i];
            if( c == 0x0 ) os << "!";
            else if( c == 0x0f ) os << " ";
            else if( c == 0x17 ) os << ":";
            else if( c == 0x14 ) os << ":";
            else if( c == 0x10 ) os << ":";
            else if( c == 0x16 ) os << ":";
            else if( c == 0x08 ) os << ":";
            else if( c == 0x0b ) os << ":";
            else if( c == 0x0e ) os << ":";
            else if( c == 0x07 ) os << ":";
            else os << c;
        }
        os << " ";
    }
    else
    {
        (void)len;
        os << " " << buffer << " ";
    }
}

bool DumpADAC( std::istream & is )
{
    std::ostream &os = std::cout;
    char magic[6 + 1];
    magic[6] = 0;
    is.read( magic, 6);
    // std::cout << magic << " ";
    assert( strcmp( magic, "adac01" ) == 0 );
    int c = is.get();
    assert( c == 0 ); (void)c;
    c = is.get();
    assert( c == 'X' );
    uint16_t v;
    v = readint16(is);
    // std::cout << v << std::endl;
    assert( v == 512 ); (void)v; // ??
    int nel = 87;
    for (int i = 0; i <= nel; ++i )
    {
        readelement( is );
    }
    char buffer[512];
    for( int i = 0; i <= nel; ++i )
    {
        const el &e = Vel[i];
        int diff;
        if( i == nel )
        {
            diff = 2048 - e.v3;
            if( diff > 512 ) diff = 512;
        }
        else
        {
            const el &enext = Vel[i+1];
            diff = enext.v3 - e.v3;
        }
        is.seekg( e.v3, std::ios::beg );
        //std::cout << "(" << std::hex << std::setw( 2 ) << std::setfill( '0' ) << e.v1 << ")" << std::hex << std::setw( 3
        ) << std::setfill( '0' ) << e.v2 << " ";
        printname( diff, 0, e.v1 );
        int mult = 1;
        if( e.v2 == 0 )
        {
            is.read( buffer, diff);
            buffer[ diff ] = 0;
            printascii( e.v1, buffer, diff);
        }
        else if( e.v2 == 0x100 )

```

```

    {
        mult = diff / 2;
        assert( diff == 2 * mult );
        for ( int ii = 0; ii < mult; ++ii )
        {
            if ( ii ) os << "\\ ";
            uint16_t val = readint16(is);
            os << " " << std::dec << val << " ";
        }
    }
    else if( e.v2 == 0x200 )
    {
        assert( diff == 4 );
        uint32_t val = readint32(is);
        os << " " << std::dec << val << " ";
    }
    else if( e.v2 == 0x300 )
    {
        assert( diff == 4 );
        float val = readfloat32(is);
        os << " " << std::dec << val << " ";
    }
    else
    {
        assert( 0 );
    }
    os << std::endl;
}
return true;
}
int main(int argc, char *argv[])
{
    if( argc < 2 ) return 1;
    const char *filename = argv[1];
    gdcm::Reader reader;
    reader.SetFileName( filename );
    if( !reader.Read() )
    {
        std::cerr << "Failed to read: " << filename << std::endl;
        return 1;
    }
    const gdcm::DataSet& ds = reader.GetFile().GetDataSet();
    // (0019,1061) UN (OB) 61\64\61\63\30 # 2048,1 Ver200 ADAC Pegasys Headers
    const gdcm::PrivateTag tver200adacpegasysheaders(0x0019,0x61,"ADAC_IMG");
    if( !ds.FindDataElement( tver200adacpegasysheaders ) ) return 1;
    const gdcm::DataElement& ver200adacpegasysheaders = ds.GetDataElement( tver200adacpegasysheaders );
    if ( ver200adacpegasysheaders.IsEmpty() ) return 1;
    const gdcm::ByteValue * bv = ver200adacpegasysheaders.GetByteValue();
    // (0019,1021) US 1 # 2,1 Ver200 Number of ADAC Headers
    // TODO
    // (0019,1041) IS [2048\221184 ] # 12,1-n Ver200 ADAC Header/Image Size
    if( bv->GetLength() != 2048 ) return 1;
    gdcm::Element<gdcm::VR::IS,gdcm::VM::VM2> el;
    const gdcm::PrivateTag tver200adacheaderimagesize(0x0019,0x41,"ADAC_IMG");
    if( !ds.FindDataElement( tver200adacheaderimagesize ) ) return 1;
    const gdcm::DataElement& ver200adacheaderimagesize = ds.GetDataElement( tver200adacheaderimagesize );
    el.SetFromDataElement( ver200adacheaderimagesize );
    if( el.GetValue(0) != 2048 ) return 1;
    std::iostream is;
    std::string dup( bv->GetPointer(), bv->GetLength() );
    is.str( dup );
    bool b = DumpADAC( is );
    if( !b ) return 1;
    return 0;
}

```

## 12.49 DumpExamCard.cxx

```

/*=====
Program: GDCM (Grassroots DICOM). A DICOM library

Copyright (c) 2006-2011 Mathieu Malaterre
All rights reserved.
See Copyright.txt or http://gdcm.sourceforge.net/Copyright.html for details.

This software is distributed WITHOUT ANY WARRANTY; without even

```

the implied warranty of MERCHANTABILITY or FITNESS FOR A PARTICULAR PURPOSE. See the above copyright notice for more information.

```

=====*/
/*

    Try to extract contents of Philips RAW storage class:

(0002,0002) UI [1.2.840.10008.5.1.4.1.1.66]           # 26,1 Media Storage SOP Class UID
(0002,0003) UI [1.3.46.670589.11.17240.5.23.4.1.3012.2010032409482568018] # 56,1 Media Storage SOP
    Instance UID
(0002,0010) UI [1.2.840.10008.1.2.1]                 # 20,1 Transfer Syntax UID
(0002,0012) UI [1.3.46.670589.11.0.0.51.4.4.1]       # 30,1 Implementation Class UID
(0002,0013) SH [MR DCOM 4.1]                         # 12,1 Implementation Version Name

* Everything done in this code is for the sole purpose of writing interoperable
* software under Sect. 1201 (f) Reverse Engineering exception of the DMCA.
* If you believe anything in this code violates any law or any of your rights,
* please contact us (gdcmm-developers@lists.sourceforge.net) so that we can
* find a solution.
*
* Everything you do with this code is at your own risk, since decompression
* algorithm was not written from specification documents.
*
* Special thanks to:
* Triplett,William T for bringing to your attention on this ExamCard stuff
*/
#include "gdcmmReader.h"
#include "gdcmmDataSet.h"
#include "gdcmmPrivateTag.h"
#include "gdcmmBase64.h"
#include <iomanip>
static bool compfn(const char *s1, const char *s2)
{
    return strcmp(s1,s2) < 0 ? true : false;
}
static const char *PDFStrings[] = { // Keep me ordered please
    "COILSTATE", // series of string ?
    "HARDWARE_CONFIG", // series of number ?
    "PDF_CONTROL_GEN_PARS",
    "PDF_CONTROL_PREP_PARS",
    "PDF_CONTROL_RECON_PARS",
    "PDF_CONTROL_SCAN_PARS",
    "PDF_EXAM_PARS",
    "PDF_HARDWARE_PARS",
    "PDF_PREP_PARS",
    "PDF_PRESCAN_COIL_PARS",
    "PDF_SPT_PARS",
};
static bool isvalidpdfstring( const char *pdfstring )
{
    assert( pdfstring );
    static const size_t n = sizeof( PDFStrings ) / sizeof( *PDFStrings );
    static const char **begin = PDFStrings;
    static const char **end = begin + n;
    return std::binary_search(begin, end, pdfstring, compfn);
}
typedef enum
{
    param_float = 0,
    param_integer = 1, // 1 << 0
    param_string = 2, // 1 << 1
    param_3, // ??
    param_enum = 4 // 1 << 2
} param_type;
static const char *gettypenamefromtype( int i)
{
    const char *ret = nullptr;
    param_type e = (param_type)i;
    switch( e )
    {
        {
        case param_float:
            ret = "float";
            break;
        case param_integer:
            ret = "int";
            break;
        case param_string:
            ret = "string";
            break;
        case param_3:

```



```

    ret = "??";
    break;
case param_enum:
    ret = "enum";
    break;
}
assert( ret );
return ret;
}
struct header
{
/*
* TODO:
* Looks as if we could read all int*, float* and string* at once...
*/
int32_t v1; // offset to int pointer array ?
uint16_t nints; // number of ints (max number?)
uint16_t v3; // always 0 ?
int32_t v4; // offset to float pointer array ?
uint32_t nfloats;
int32_t v6; // offset to string pointer array ?
uint32_t nstrings;
int32_t v8; // always 8 ??
uint32_t numparams;
uint32_t getnints() const { return nints; }
uint32_t getnfloats() const { return nfloats; }
uint32_t getnstrings() const { return nstrings; }
uint32_t getnparams() const { return numparams; }
void read( std::istream & is )
{
    is.read( (char*)&v1, sizeof(v1));
    if( v1 == 0x01 ) {
        // direct (FIXME how should we detect this, much like TIFF ???)
        nints = 0;
        v3 = 0;
        v4 = 0;
        nfloats = 0;
        v6 = 0;
        nstrings = 0;
        v8 = 0;
        numparams = 0;
        uint32_t bla;
        is.read( (char*)&bla, sizeof(bla) );
        assert( bla == 0x2 || bla == 0x3 );
        nstrings = 1;
        numparams = 1;
    } else {
        // indirect
        is.read( (char*)&nints, sizeof(nints));
        is.read( (char*)&v3, sizeof(v3));
        assert( v3 == 0 ); // looks like this is always 0
        is.read( (char*)&v4, sizeof(v4));
        is.read( (char*)&nfloats, sizeof(nfloats));
        is.read( (char*)&v6, sizeof(v6));
        is.read( (char*)&nstrings, sizeof(nstrings));
        is.read( (char*)&v8, sizeof(v8));
        assert( v8 == 8 );
        is.read( (char*)&numparams, sizeof(numparams));
    }
}
void print( std::ostream & os )
{
    os << v1 << ", ";
    os << nints << ", ";
    os << v3 << ", ";
    os << v4 << ", ";
    os << nfloats << ", ";
    os << v6 << ", ";
    os << nstrings << ", ";
    os << v8 << ", ";
    os << numparams << std::endl;
}
};
struct param
{
    char name[32+1];
    uint8_t boolean;
    int32_t type;
    uint32_t dim;
    union {
        uint32_t val;

```

```

char * ptr; } v4;
int32_t /*std::streamoff*/ offset;
param_type gettype() const { return (param_type)type; }
uint32_t getdim() const { return dim; }
void read_direct_int( std::istream & is ) {
    uint32_t bla;
    int max = 9;
    std::vector<uint32_t> v;
    for( int i = 0; i < max; ++i ) {
        is.read( (char*)&bla, sizeof(bla) );
        v.push_back( bla );
    }
    is.read( (char*)&bla, sizeof(bla) );
    char name0[32];
    memset(name0,0,sizeof(name0));
    assert( bla < sizeof(name0) );
    is.read( name0, bla );
    size_t l = strlen(name0);
    assert( l == bla ); (void)l;
    char * ptr = strdup( name0 );
    v4.ptr = ptr;
    type = param_string;
    dim = 1;
    offset = 0; // important !
}
void read_direct_string( std::istream & is ) {
    uint32_t bla;
    is.read( (char*)&bla, sizeof(bla) );
    char name0[32];
    memset(name0,0,sizeof(name0));
    assert( bla < sizeof(name0) );
    is.read( name0, bla );
    size_t l = strlen(name0);
    assert( l == bla ); (void)l;
    memcpy( this->name, name0, bla );
    is.read( (char*)&bla, sizeof(bla) );
    assert( bla == 0x1 );
    is.read( (char*)&bla, sizeof(bla) );
    char value[32];
    memset(value,0,sizeof(value));
    assert( bla < sizeof(value) );
    is.read( value, bla );
    is.read( (char*)&bla, sizeof(bla) );
    assert( bla == 0 ); // trailing stuff ?
    is.read( (char*)&bla, sizeof(bla) );
    assert( bla == 0 ); // trailing stuff ?
    const uint32_t cur = (uint32_t)is.tellg();
    std::cerr << "offset:" << cur << std::endl;
    if( cur == 65 )
        is.read( (char*)&bla, 1 );
    else if( cur == 66 )
        is.read( (char*)&bla, 1 );
    else if( cur == 122 )
        is.read( (char*)&bla, 2 );
    else
        assert(0);
    type = param_string;
    dim = 1;
    // FIXME: store the value in v4 for now:
    char * ptr = strdup( value );
    v4.ptr = ptr;
    offset = 0; // important !
}
void read( std::istream & is )
{
    is.read( name, 32 + 1 );
    // This is always the same issue the string can contains garbage from previous run,
    // we need to print only until the first \0 character:
    assert( strlen( name ) <= 32 );
    is.read( (char*)&boolean,1);
    assert( boolean == 0 || boolean == 1 || boolean == 0x69 ); // some kind of bool, or digital trash ?
    is.read( (char*)&type, sizeof( type ) );
    assert( gettypenamefromtype( type ) );
    is.read( (char*)&dim, sizeof( dim ) ); // number of elements
    is.read( (char*)&v4.val, sizeof( v4.val ) );
    //assert( v4.val == 0 ); // always 0 ? sometimes not...
    const uint32_t cur = (uint32_t)is.tellg();
    is.read( (char*)&offset, sizeof( offset ) );
    assert( offset != 0 );
    offset += cur;
}

```

```

void print( std::ostream & os ) const
{
    os << name << ", ";
    os << (int)boolean << ", ";
    os << type << ", ";
    os << dim << ", ";
    os << v4.val << ", ";
    os << offset << std::endl;
}

void printvalue( std::ostream & os, std::istream & is ) const
{
    if( offset ) {
        is.seekg( offset );
        switch( type )
        {
            case param_float:
                {
                    os.precision(2);
                    os << std::fixed;
                    for( uint32_t idx = 0; idx < dim; ++idx )
                    {
                        if( idx ) os << ", ";
                        float v;
                        is.read( (char*)&v, sizeof(v) );
                        os << v; // what if the string contains \0 ?
                    }
                }
                break;
            case param_integer:
                {
                    int32_t v;
                    for( uint32_t idx = 0; idx < dim; ++idx )
                    {
                        if( idx ) os << ", ";
                        is.read( (char*)&v, sizeof(v) );
                        os << v;
                    }
                }
                break;
            case param_string:
                {
                    int size = 81;
                    std::string v;
                    v.resize( size );
                    for( uint32_t idx = 0; idx < dim; ++idx )
                    {
                        if( idx ) os << ", ";
                        is.read( &v[0], size );
                        os << v.c_str();
                    }
                }
                break;
            case param_enum:
                {
                    int32_t v;
                    for( uint32_t idx = 0; idx < dim; ++idx )
                    {
                        if( idx ) os << ", ";
                        is.read( (char*)&v, sizeof(v) );
                        os << v;
                    }
                }
                break;
        }
    }
    else {
#ifdef 1
        // direct
        assert ( type == param_string );
        char * ptr = v4.ptr;
        //std::string v;
        //v.resize( dim );
        //is.read( &v[0], dim );
        os << ptr;
#endif
    }
}

void printxml( std::ostream & os, std::istream & is ) const
{
    // <Attribute Name="CGEN_force_par_mode" Type="enum">0</Attribute>
    os << " <Attribute";
    os << " Name=\"" << name << "\"";
}

```

```

os << " Type=\"\" << gettypenamefromtype(type) << "\"";
if( dim != 1 )
{
os << " ArraySize=\"\" << dim << "\"";
}
os << ">";
printvalue( os, is );
os << "</Attribute>\n";
}
void printcsv( std::ostream & os, std::istream & is ) const
{
os << std::setw(32) << std::left << name << ", ";
os << std::setw(7) << std::right << gettypenamefromtype(type) << ", ";
os << std::setw(4) << dim << ", ";
os << " ";
printvalue( os, is );
os << ",\n";
}
};
static bool ProcessNested( gdcM::DataSet & ds )
{
/*
TODO:
Looks like the real length of the blob is stored here:
(2005,1132) SQ # u/1,1 ?
(fffe,e000) na (Item with undefined length)
(2005,0011) LO [Philips MR Imaging DD 002 ] # 26,1 Private Creator
(2005,1143) SL 3103 # 4,1 ?

Wotsit ?
(2005,1132) SQ # u/1,1 ?
(fffe,e000) na (Item with undefined length)
(2005,0011) LO [Philips MR Imaging DD 002 ] # 26,1 Private Creator
(2005,1147) CS [Y ] # 2,1 ?
*/
bool ret = false;
// (2005,1137) PN (LO) [PDF_CONTROL_GEN_PARS] # 20,1 Protocol Data Name
const gdcM::PrivateTag pt0(0x2005,0x37,"Philips MR Imaging DD 002");
if( !ds.FindDataElement( pt0 ) ) return false;
const gdcM::DataElement &de0 = ds.GetDataElement( pt0 );
if( de0.IsEmpty() ) return false;
const gdcM::ByteValue * bv0 = de0.GetByteValue();
std::string s0( bv0->GetPointer() , bv0->GetLength() );
// (2005,1139) LO [IEEE_PDF] # 8,1 Protocol Data Type
const gdcM::PrivateTag pt1(0x2005,0x39,"Philips MR Imaging DD 002");
if( !ds.FindDataElement( pt1 ) ) return false;
const gdcM::DataElement &de1 = ds.GetDataElement( pt1 );
// (2005,1143) SL 53 # 4,1 Protocol Data Block Length (non-padded)
const gdcM::PrivateTag pt2(0x2005,0x43,"Philips MR Imaging DD 002");
if( !ds.FindDataElement( pt2 ) ) return false;
const gdcM::DataElement &de2 = ds.GetDataElement( pt2 );
// (2005,1147) CS [Y ] # 2,1 Protocol Data Boolean
const gdcM::PrivateTag pt3(0x2005,0x47,"Philips MR Imaging DD 002");
if( !ds.FindDataElement( pt3 ) ) return false;
const gdcM::DataElement &de3 = ds.GetDataElement( pt3 );
(void)de3;
// (2005,1144) OW 00\00\00\00\05\00\00\00\35\2e\31\2e\37\00 # 54,1 Protocol Data Block
const gdcM::PrivateTag pt(0x2005,0x44,"Philips MR Imaging DD 002");
if( !ds.FindDataElement( pt ) ) return false;
const gdcM::DataElement &de = ds.GetDataElement( pt );
if( de.IsEmpty() ) return false;
const gdcM::ByteValue * bv = de.GetByteValue();
if( s0 == "ExamCardBlob" )
{
assert( de1.IsEmpty() );
std::string fn = gdcM::LOComp::Trim( s0.c_str() ); // remove trailing space
fn += ".xml";
std::ofstream out( fn.c_str() );
// remove trailing \0
size_t len = strlen( bv->GetPointer() );
out.write( bv->GetPointer() , len );
out.close();
// Extract binary64 thingy (this is a ugly hack, better use an XML parser)
std::string dup( bv->GetPointer(), len );
std::string::size_type pos1 = dup.find( "<ExamCardBlob>" );
std::string::size_type pos2 = dup.find( "</ExamCardBlob>" );
std::string b64( bv->GetPointer() + pos1 + 14, pos2 - (pos1 + 14) );
// ulgy hack to remove \r\n from input base64:
std::string::iterator r_pos = std::remove( b64.begin(), b64.end(), '\r' );
b64.erase( r_pos, b64.end() );
std::string::iterator n_pos = std::remove( b64.begin(), b64.end(), '\n' );

```

```

    b64.erase(n_pos, b64.end());
#if 0
    std::ofstream out2( "debug" );
    out2.write( b64.c_str(), b64.size() );
    out2.close();
#endif
    const size_t dlen = gdcM::Base64::GetDecodeLength(b64.c_str(), b64.size() );
    std::string decoded;
    decoded.resize( dlen );
    gdcM::Base64::Decode( &decoded[0], decoded.size(), b64.c_str(), b64.size() );
    std::ofstream f64( "soap.xml" );
    f64.write( decoded.c_str(), decoded.size() );
    f64.close();
    ret = true;
}
else
{
    if( del.IsEmpty() ) return false;
    const gdcM::ByteValue * bv1 = del.GetByteValue();
    gdcM::Element<gdcM::VR::SL,gdcM::VM::VM1> dlen = {{01}};
    dlen.SetFromDataElement( de2 );
    std::string s1( bv1->GetPointer() , bv1->GetLength() );
    if( s1 == "IEEE_PDF" )
    {
        std::istream is;
        assert( bv->GetLength() == (size_t)dlen.GetValue() || bv->GetLength() == (size_t)(dlen.GetValue() + 1) );
        std::string dup( bv->GetPointer(), dlen.GetValue() /*bv->GetLength()*/ );
        is.str( dup );
        header h;
        h.read( is );
        //assert( is.peek() && is.eof() );
    }
}
#if 1
    static int c = 0;
    std::string fn0 = gdcM::LOComp::Trim( s1.c_str() ); // remove trailing space
    std::stringstream ss;
    ss << fn0 << "_" << c++;
    if( h.v1 == 0x01 )
        ss << ".direct";
    else
        ss << ".indirect";
    std::cout << "fn0=" << ss.str() << " Len=" << bv->GetLength() << std::endl;
    std::ofstream out( ss.str().c_str() );
    out.write( bv->GetPointer(), bv->GetLength() );
    out.close();
#endif
#if 1
    std::cout << dup.c_str() << std::endl;
    h.print( std::cout );
#endif
    std::vector< param > params;
    if( h.v1 == 0x01 ) {
        for( uint32_t i = 0; i < 1 /* h.getnparams()*/; ++i ) {
            param p;
            if( s0 == "HARDWARE_CONFIG " )
            {
                p.read_direct_int( is );
            }
            else if( s0 == "COILSTATE " )
            {
                p.read_direct_string( is );
            }
            else
            {
                assert(0);
            }
            params.push_back( p );
        }
    }
    else {
        assert( is.tellg() == std::streampos(0x20) );
        is.seekg( 0x20 );
        param p;
        for( uint32_t i = 0; i < h.getnparams(); ++i )
        {
            p.read( is );
            //p.print( std::cout );
            params.push_back( p );
        }
    }
    std::string fn = gdcM::LOComp::Trim( s0.c_str() ); // remove trailing space
    bool b1 = isvalidpdfstring( fn.c_str() );
    assert( b1 ); (void)b1;
}

```

```

fn += ".csv";
//fn += ".xml";
std::ofstream csv( fn.c_str() );
// let's do some bookkeeping:
uint32_t nfloats = 0;
uint32_t nints = 0;
uint32_t nstrings = 0;
for( std::vector<param>::const_iterator it = params.begin();
      it != params.end(); ++it )
{
    param_type type = it->gettype();
    switch( type )
    {
        case param_float:
            nfloats += it->getdim();
            break;
        case param_integer:
            nints += it->getdim();
            break;
        case param_string:
            nstrings += it->getdim();
            break;
        default:
            ;
    }
}
#endif
std::cout << "Stats:" << std::endl;
std::cout << "nfloats:" << nfloats << std::endl;
std::cout << "nints:" << nints << std::endl;
std::cout << "nstrings:" << nstrings << std::endl;
#endif
assert( h.getnints() >= nints );
assert( h.getnfloats() >= nfloats );
assert( h.getnstrings() >= nstrings );
for( uint32_t i = 0; i < h.getnparams(); ++i )
{
    params[i].printcsv( csv, is );
    //params[i].printxml( csv, is );
}
csv.close();
ret = true;
}
else if( s1 == "ASCII " )
{
#ifdef 0
std::cerr << "ASCII is not handled" << std::endl;
std::string fn = gdc::LOComp::Trim( s0.c_str() ); // remove trailing space
fn += ".asc";
std::ofstream out( fn.c_str() );
out.write( bv->GetPointer() , bv->GetLength() );
out.close();
#endif
std::string fn = gdc::LOComp::Trim( s0.c_str() ); // remove trailing space
fn += ".sin";
std::ofstream sin( fn.c_str() );
const char *beg = bv->GetPointer();
const char *end = beg + bv->GetLength();
assert( *beg == 0 );
const char *p = beg + 1; // skip first \0
size_t prev = 0;
for( ; p != end; ++p )
{
    if( *p == 0 )
    {
        const char *s = beg + prev + 1;
        if( *s )
        {
            sin << s << std::endl;
        }
        else
        {
            sin << std::endl;
        }
        prev = p - beg;
    }
}
sin.close();
ret = true;
}
else if( s1 == "BINARY" )

```

```

    {
        std::cerr << "BINARY is not handled" << std::endl;
        std::string fn = gdcm::LOComp::Trim( s0.c_str() ); // remove trailing space
        fn += ".bin";
        std::ofstream out( fn.c_str() );
        //out.write( bv->GetPointer() + 512, bv->GetLength() - 512);
        out.write( bv->GetPointer() , bv->GetLength() );
        out.close();
    }
#endif
    int array[ 128 ];
    memcpy( array, bv->GetPointer(), 512 );
    for( int i = 0; i < 14; ++i )
    {
        std::cout << array[i] << std::endl;
    }
#endif
    ret = true;
}
// else -> ret == false
assert( ret );
return ret;
}
int main(int argc, char *argv[])
{
    if( argc < 2 ) return 1;
    const char *filename = argv[1];
    gdcm::Reader reader;
    reader.SetFileName( filename );
    if( !reader.Read() )
    {
        std::cerr << "Failed to read: " << filename << std::endl;
        return 1;
    }
    const gdcm::DataSet& ds = reader.GetFile().GetDataSet();
    /*
(2005,1132) SQ # u/1,1 ?
(fffe,e000) na (Item with undefined length)
(2005,0011) LO [Philips MR Imaging DD 002 ] # 26,1 Private Creator
(2005,1137) PN (LO) [PDF_CONTROL_GEN_PARS] # 20,1 ?
(2005,1138) PN (LO) (no value) # 0,1 ?
(2005,1139) PN (LO) [IEEE_PDF] # 8,1 ?
(2005,1140) PN (LO) (no value) # 0,1 ?
(2005,1141) PN (LO) (no value) # 0,1 ?
(2005,1143) SL 3103 # 4,1 ?
(2005,1144) OW
66\05\00\00\3b\01\00\00\4a\0a\00\00\0e\00\00\00\7a\0a\00\00\95\01\00\00\08\00\00\00\1b\00\00\00\43\47\45\4e\5f\75\73\65\72\
# 3104,1 ?
(2005,1147) CS [Y ] # 2,1 ?
(fffe,e00d)
*/
    const gdcm::PrivateTag pt(0x2005,0x32,"Philips MR Imaging DD 002");
    if( !ds.FindDataElement( pt ) ) return 1;
    const gdcm::DataElement &de = ds.GetDataElement( pt );
    if( de.IsEmpty() ) return 1;
    gdcm::SequenceOfItems *sqi = de.GetValueAsSQ();
    if ( !sqi ) return 1;
    gdcm::SequenceOfItems::SizeType s = sqi->GetNumberOfItems();
    for( gdcm::SequenceOfItems::SizeType i = 1; i <= s; ++i )
    {
        gdcm::Item &item = sqi->GetItem(i);
        gdcm::DataSet &nestedds = item.GetNestedDataSet();
        if( !ProcessNested( nestedds ) ) {
            std::cerr << "Error processing Item #" << i << std::endl;
        }
    }
    return 0;
}

```

## 12.50 DumpGEMSMovieGroup.cxx

```

/*=====
Program: GDCM (Grassroots DICOM). A DICOM library

Copyright (c) 2006-2011 Mathieu Malaterre
All rights reserved.

```

See Copyright.txt or <http://gdcm.sourceforge.net/Copyright.html> for details.

This software is distributed WITHOUT ANY WARRANTY; without even the implied warranty of MERCHANTABILITY or FITNESS FOR A PARTICULAR PURPOSE. See the above copyright notice for more information.

```

=====*/
#include "gdcmReader.h"
#include "gdcmImage.h"
#include "gdcmImageWriter.h"
#include "gdcmDataElement.h"
#include "gdcmPrivateTag.h"
#include "gdcmUIDGenerator.h"
#include <iostream>
#include <string>
#include <map>
bool PrintNameValueMapping( gdcm::SequenceOfItems *sqi_values,
gdcm::SequenceOfItems *sqi_names, std::string const & indent )
{
    using namespace gdcm;
    // prepare names mapping:
    typedef VRToType<VR::UL::Type UL;
    std::map< UL, std::string > names;
    assert( sqi_names );
    assert( sqi_values );
    SequenceOfItems::SizeType s = sqi_names->GetNumberOfItems();
    PrivateTag tindex(0x7fe1,0x71,"GEMS_Ultrasound_MovieGroup_001");
    PrivateTag tname (0x7fe1,0x72,"GEMS_Ultrasound_MovieGroup_001");
    // First sequence contains all possible names (this is a dict)
    for( SequenceOfItems::SizeType i = 1; i <= s; ++i )
    {
        const Item & item = sqi_names->GetItem( i );
        const DataSet & ds = item.GetNestedDataSet();
        if( !ds.FindDataElement( tindex )
            || !ds.FindDataElement( tname ) )
        {
            assert( 0 );
            return false;
        }
        const DataElement & index = ds.GetDataElement( tindex );
        const DataElement & name = ds.GetDataElement( tname );
        if( index.IsEmpty() || name.IsEmpty() )
        {
            assert( 0 );
            return false;
        }
        gdcm::Element<VR::UL, VM::VM1> e11;
        e11.SetFromDataElement( index );
        gdcm::Element<VR::LO, VM::VM1> e12;
        e12.SetFromDataElement( name );
        // std::cout << e11.GetValue() << " " << e12.GetValue() << std::endl;
        names.insert( std::make_pair( e11.GetValue(), e12.GetValue() ) );
    }
    SequenceOfItems::SizeType s2 = sqi_values->GetNumberOfItems();
    assert( s2 <= s );
    PrivateTag tindex2(0x7fe1,0x48,"GEMS_Ultrasound_MovieGroup_001");
    for( SequenceOfItems::SizeType i = 1; i <= s2; ++i )
    {
        const Item & item = sqi_values->GetItem( i );
        const DataSet & ds = item.GetNestedDataSet();
        if( !ds.FindDataElement( tindex2 ) )
        {
            assert( 0 );
            return false;
        }
        const DataElement & index2 = ds.GetDataElement( tindex2 );
        if( index2.IsEmpty() )
        {
            assert( 0 );
            return false;
        }
        gdcm::Element<VR::FD, VM::VM1_2> e11;
        e11.SetFromDataElement( index2 );
        UL copy = (UL)e11.GetValue();
    #if 1
        std::cout << indent;
        std::cout << "( " << names[ copy ];
    #endif
        // (7fe1,1052) FD 1560 # 8,1 ?
        // (7fe1,1057) LT [MscSkelSup] # 10,1 ?
        //PrivateTag tvalue(0x7fe1,0x52,"GEMS_Ultrasound_MovieGroup_001");

```



```

PrivateTag tvalueint(0x7fe1,0x49,"GEMS_Ultrasound_MovieGroup_001"); // UL
PrivateTag tvaluefloat1(0x7fe1,0x51,"GEMS_Ultrasound_MovieGroup_001"); // FL
PrivateTag tvaluefloat(0x7fe1,0x52,"GEMS_Ultrasound_MovieGroup_001"); // FD
PrivateTag tvalueul(0x7fe1,0x53,"GEMS_Ultrasound_MovieGroup_001"); // UL
PrivateTag tvaluesl(0x7fe1,0x54,"GEMS_Ultrasound_MovieGroup_001"); // SL
PrivateTag tvalueob(0x7fe1,0x55,"GEMS_Ultrasound_MovieGroup_001"); // OB
PrivateTag tvaluetext(0x7fe1,0x57,"GEMS_Ultrasound_MovieGroup_001"); // LT
PrivateTag tvaluefd(0x7fe1,0x77,"GEMS_Ultrasound_MovieGroup_001"); // FD / 1-N
PrivateTag tvaluesl3(0x7fe1,0x79,"GEMS_Ultrasound_MovieGroup_001"); // SL / 1-N
PrivateTag tvaluesl2(0x7fe1,0x86,"GEMS_Ultrasound_MovieGroup_001"); // SL ??
PrivateTag tvaluefdl(0x7fe1,0x87,"GEMS_Ultrasound_MovieGroup_001"); // FD / 1-N
PrivateTag tvaluefloat2(0x7fe1,0x88,"GEMS_Ultrasound_MovieGroup_001"); // FD ??

#if 1
std::cout << " ) = ";
#endif
if( ds.FindDataElement( tvalueint ) )
{
    const DataElement & value = ds.GetDataElement( tvalueint );
    gdcm::Element<VR::UL,VM:VM1> e12;
    e12.SetFromDataElement( value );
    std::cout << e12.GetValue() << std::endl;
}
else if( ds.FindDataElement( tvaluefloat1 ) )
{
    const DataElement & value = ds.GetDataElement( tvaluefloat1 );
    gdcm::Element<VR::FL,VM:VM1> e12;
    e12.SetFromDataElement( value );
    std::cout << e12.GetValue() << std::endl;
}
else if( ds.FindDataElement( tvaluefloat ) )
{
    const DataElement & value = ds.GetDataElement( tvaluefloat );
    gdcm::Element<VR::FD,VM:VM1> e12;
    e12.SetFromDataElement( value );
    std::cout << e12.GetValue() << std::endl;
}
else if( ds.FindDataElement( tvaluesl ) )
{
    const DataElement & value = ds.GetDataElement( tvaluesl );
    gdcm::Element<VR::SL,VM:VM1> e12;
    e12.SetFromDataElement( value );
    std::cout << e12.GetValue() << std::endl;
}
else if( ds.FindDataElement( tvalueul ) )
{
    const DataElement & value = ds.GetDataElement( tvalueul );
    gdcm::Element<VR::UL,VM:VM1_n> e12;
    e12.SetFromDataElement( value );
    assert( e12.GetLength() == 1 );
    std::cout << e12.GetValue() << std::endl;
}
else if( ds.FindDataElement( tvalueob ) )
{
    const DataElement & value = ds.GetDataElement( tvalueob );
    // gdcm::Element<VR::SL,VM:VM1> e12;
    // e12.SetFromDataElement( value );
    // std::cout << e12.GetValue() << std::endl;
    std::cout << value << std::endl;
}
else if( ds.FindDataElement( tvaluetext ) )
{
    const DataElement & value = ds.GetDataElement( tvaluetext );
    gdcm::Element<VR::LT,VM:VM1> e12;
    e12.SetFromDataElement( value );
    std::cout << e12.GetValue() << std::endl;
}
else if( ds.FindDataElement( tvaluesl2 ) )
{
    const DataElement & value = ds.GetDataElement( tvaluesl2 );
    gdcm::Element<VR::SL,VM:VM1_n> e12;
    e12.SetFromDataElement( value );
    e12.Print( std::cout );
    assert( e12.GetLength() == 4 );
    std::cout << std::endl;
}
else if( ds.FindDataElement( tvaluesl3 ) )
{
    const DataElement & value = ds.GetDataElement( tvaluesl3 );
    gdcm::Element<VR::SL,VM:VM1_n> e12;
    e12.SetFromDataElement( value );
    e12.Print( std::cout );
}

```

```

//      assert( el2.GetLength() == 4 );
std::cout << std::endl;
}
else if( ds.FindDataElement( tvaluefd ) )
{
    const DataElement & value = ds.GetDataElement( tvaluefd );
    gdcmm::Element<VR::FD,VM::VM1_n> el2;
    el2.SetFromDataElement( value );
    el2.Print( std::cout );
//      assert( el2.GetLength() == 4 || el2.GetLength() == 3 || el2.GetLength() == 8 );
std::cout << std::endl;
}
else if( ds.FindDataElement( tvaluefloat2 ) )
{
    const DataElement & value = ds.GetDataElement( tvaluefloat2 );
    gdcmm::Element<VR::FD,VM::VM1_n> el2;
    el2.SetFromDataElement( value );
    el2.Print( std::cout );
    assert( el2.GetLength() == 2 );
    std::cout << std::endl;
}
else if( ds.FindDataElement( tvaluefd1 ) )
{
    const DataElement & value = ds.GetDataElement( tvaluefd1 );
    gdcmm::Element<VR::FD,VM::VM1_n> el2;
    el2.SetFromDataElement( value );
    el2.Print( std::cout );
    assert( el2.GetLength() == 4 );
    std::cout << std::endl;
}
else
{
    std::cout << "(no value)" << std::endl;
//      std::cout << ds << std::endl;
    assert( ds.Size() == 2 );
}
}
return true;
}
bool PrintNameValueMapping2( gdcmm::PrivateTag const & privtag, const gdcmm::DataSet & ds ,
    gdcmm::SequenceOfItems *sqi_names, std::string const & indent )
{
    if( !ds.FindDataElement( privtag ) ) return false;
    const gdcmm::DataElement& seq_values = ds.GetDataElement( privtag );
    gdcmm::SmartPointer<gdcmm::SequenceOfItems> sqi = seq_values.GetValueAsSQ();
    return PrintNameValueMapping( sqi, sqi_names, indent);
}
bool PrintNameValueMapping3( gdcmm::PrivateTag const & privtag1, gdcmm::PrivateTag const & privtag2, const
    gdcmm::DataSet & ds ,
    gdcmm::SequenceOfItems *sqi_names, std::string const & indent )
{
    if( !ds.FindDataElement( privtag1 ) )
    {
        assert( 0 );
        return false;
    }
    const gdcmm::DataElement& values10name = ds.GetDataElement( privtag1 );
    gdcmm::Element<gdcmm::VR::LO,gdcmm::VM::VM1> el;
    el.SetFromDataElement( values10name );
    std::cout << std::endl;
    std::cout << " <" << el.GetValue().c_str() << ">" << std::endl;
    return PrintNameValueMapping2( privtag2, ds, sqi_names, indent);
}
bool print73( gdcmm::DataSet const & ds10, gdcmm::SequenceOfItems *sqi_dict, std::string const & indent )
{
    const gdcmm::PrivateTag tseq_values73(0x7fe1,0x73,"GEMS_Ultrasound_MovieGroup_001");
    if( !ds10.FindDataElement( tseq_values73 ) )
    {
        std::cout << indent << "No group 73" << std::endl;
        return false;
    }
    const gdcmm::DataElement& seq_values73 = ds10.GetDataElement( tseq_values73 );
    gdcmm::SmartPointer<gdcmm::SequenceOfItems> sqi_values73 = seq_values73.GetValueAsSQ();
    size_t ni3 = sqi_values73->GetNumberOfItems();
    for( size_t i3 = 1; i3 <= ni3; ++i3 )
    {
        gdcmm::Item &item_73 = sqi_values73->GetItem(i3);
        gdcmm::DataSet &ds73 = item_73.GetNestedDataSet();
        assert( ds73.Size() == 3 );
        const gdcmm::PrivateTag tseq_values74name(0x7fe1,0x74,"GEMS_Ultrasound_MovieGroup_001");
        const gdcmm::PrivateTag tseq_values75(0x7fe1,0x75,"GEMS_Ultrasound_MovieGroup_001");

```

```

    PrintNameValueMapping3( tseq_values74name, tseq_values75, ds73, sqi_dict, indent);
    std::cout << std::endl;
}
return true;
}
bool print36( gdcm::DataSet const & ds10, gdcm::SequenceOfItems *sqi_dict, std::string const & indent )
{
    (void)sqi_dict;
    const gdcm::PrivateTag tseq_values36(0x7fe1,0x36,"GEMS_Ultrasound_MovieGroup_001");
    if( !ds10.FindDataElement( tseq_values36 ) )
    {
        std::cout << indent << "No group 36" << std::endl;
        return false;
    }
    const gdcm::DataElement& seq_values36 = ds10.GetDataElement( tseq_values36 );
    gdcm::SmartPointer<gdcm::SequenceOfItems> sqi_values36 = seq_values36.GetValueAssQ();
    size_t ni3 = sqi_values36->GetNumberOfItems();
    assert( ni3 >= 1 );
    for( size_t i3 = 1; i3 <= ni3; ++i3 )
    {
        gdcm::Item &item_36 = sqi_values36->GetItem(i3);
        gdcm::DataSet &ds36 = item_36.GetNestedDataSet();
        assert( ds36.Size() == 4 );
        // (7fe1,1037) UL 47 # 4,1 US MovieGroup Number of Frames
        // (7fe1,1043) OB 40\00\1c\c4\67\2f\0b\11\40 # 376,1 ?
        // (7fe1,1060) OB 4e\4e\49\4f\4e\47\46\43\2a # 4562714,1 US MovieGroup Image Data
        //
        const gdcm::PrivateTag timagedata(0x7fe1,0x60,"GEMS_Ultrasound_MovieGroup_001");
        assert( ds36.FindDataElement( timagedata ) );
        gdcm::DataElement const & imagedata = ds36.GetDataElement( timagedata );
        const gdcm::ByteValue * bv = imagedata.GetByteValue();
    assert( bv );
        static int c = 0;
        std::stringstream ss;
        ss << "/tmp/debug";
        ss << c++;
        std::ofstream os( ss.str().c_str(), std::ios::binary );
        os.write( bv->GetPointer(), bv->GetLength() );
        os.close();
        //const gdcm::PrivateTag tseq_values85(0x7fe1,0x85,"GEMS_Ultrasound_MovieGroup_001");
        //PrintNameValueMapping3( tseq_values84name, tseq_values85, ds83, sqi_dict, indent);
        //std::cout << std::endl;
    }
    return true;
}
bool print83( gdcm::DataSet const & ds10, gdcm::SequenceOfItems *sqi_dict, std::string const & indent )
{
    const gdcm::PrivateTag tseq_values83(0x7fe1,0x83,"GEMS_Ultrasound_MovieGroup_001");
    if( !ds10.FindDataElement( tseq_values83 ) )
    {
        std::cout << indent << "No group 83" << std::endl;
        return false;
    }
    const gdcm::DataElement& seq_values83 = ds10.GetDataElement( tseq_values83 );
    gdcm::SmartPointer<gdcm::SequenceOfItems> sqi_values83 = seq_values83.GetValueAssQ();
    size_t ni3 = sqi_values83->GetNumberOfItems();
    for( size_t i3 = 1; i3 <= ni3; ++i3 )
    {
        gdcm::Item &item_83 = sqi_values83->GetItem(i3);
        gdcm::DataSet &ds83 = item_83.GetNestedDataSet();
        assert( ds83.Size() == 3 );
        const gdcm::PrivateTag tseq_values84name(0x7fe1,0x84,"GEMS_Ultrasound_MovieGroup_001");
        const gdcm::PrivateTag tseq_values85(0x7fe1,0x85,"GEMS_Ultrasound_MovieGroup_001");
        PrintNameValueMapping3( tseq_values84name, tseq_values85, ds83, sqi_dict, indent);
        std::cout << std::endl;
    }
    return true;
}
bool PrintNameValueMapping4( gdcm::PrivateTag const & privtag0, const gdcm::DataSet & subds, gdcm::PrivateTag
    const & privtag1, gdcm::PrivateTag const & privtag2,
gdcm::SequenceOfItems *sqi_dict, std::string const & indent )
{
    (void)indent;
    if( !subds.FindDataElement( privtag0 ) )
    {
        assert( 0 );
        return false;
    }
    const gdcm::DataElement& seq_values10 = subds.GetDataElement( privtag0 );
    gdcm::SmartPointer<gdcm::SequenceOfItems> sqi_values10 = seq_values10.GetValueAssQ();
    size_t ni1 = sqi_values10->GetNumberOfItems();

```

```

// assert( nil == 1 );
for( size_t i1 = 1; i1 <= nil; ++i1 )
{
    gdc::Item &item_10 = sqi_values10->GetItem(i1);
    gdc::DataSet &ds10 = item_10.GetNestedDataSet();
    assert( ds10.Size() == 2 + 3 );
    // (7fe1,0010)
    // (7fe1,1012)
    // (7fe1,1018)
    // (7fe1,1020)
    // (7fe1,1083)
    PrintNameValueMapping3( privtag1, privtag2, ds10, sqi_dict, " " );
    std::cout << std::endl;
    const gdc::PrivateTag tseq_values20(0x7fe1,0x20,"GEMS_Ultrasound_MovieGroup_001");
    if( !ds10.FindDataElement( tseq_values20 ) )
    {
        assert( 0 );
        return false;
    }
    const gdc::DataElement& seq_values20 = ds10.GetDataElement( tseq_values20 );
    gdc::SmartPointer<gdc::SequenceOfItems> sqi_values20 = seq_values20.GetValueAsSQ();
    size_t ni2 = sqi_values20->GetNumberOfItems();
    //assert( ni == 1 );
    for( size_t i2 = 1; i2 <= ni2; ++i2 )
    {
        gdc::Item &item_20 = sqi_values20->GetItem(i2);
        gdc::DataSet &ds20 = item_20.GetNestedDataSet();
        size_t count = ds20.Size(); (void)count;
        assert( ds20.Size() == 2 + 3 || ds20.Size() == 2 + 2 );
        // (7fe1,0010)
        // (7fe1,1024)
        // (7fe1,1026)
        // (7fe1,1036)
        // (7fe1,103a)
        // (7fe1,1083) (*)
        const gdc::PrivateTag tseq_values20name(0x7fe1,0x24,"GEMS_Ultrasound_MovieGroup_001");
        const gdc::PrivateTag tseq_values26(0x7fe1,0x26,"GEMS_Ultrasound_MovieGroup_001");
        PrintNameValueMapping3( tseq_values20name, tseq_values26, ds20, sqi_dict, " " );
        std::cout << std::endl;
        print36(ds20, sqi_dict, " ");
        print83(ds20, sqi_dict, " ");
    }
    print83(ds10, sqi_dict, " ");
}
return true;
}
int main(int argc, char *argv[])
{
    if( argc < 2 ) return 1;
    using namespace gdc;
    const char *filename = argv[1];
    gdc::Reader reader;
    reader.SetFileName( filename );
    if( !reader.Read() ) return 1;
    gdc::File &file = reader.GetFile();
    gdc::DataSet &ds = file.GetDataSet();
    const PrivateTag tseq(0x7fe1,0x1,"GEMS_Ultrasound_MovieGroup_001");
    if( !ds.FindDataElement( tseq ) ) return 1;
    const DataElement& seq = ds.GetDataElement( tseq );
    SmartPointer<SequenceOfItems> sqi = seq.GetValueAsSQ();
    assert( sqi->GetNumberOfItems() == 1 );
    Item &item = sqi->GetItem(1);
    DataSet &subds = item.GetNestedDataSet();
    const PrivateTag tseq_dict(0x7fe1,0x70,"GEMS_Ultrasound_MovieGroup_001");
    if( !subds.FindDataElement( tseq_dict ) ) return 1;
    const DataElement& seq_dict = subds.GetDataElement( tseq_dict );
    SmartPointer<SequenceOfItems> sqi_dict = seq_dict.GetValueAsSQ();
    const PrivateTag tseq_values8(0x7fe1,0x8,"GEMS_Ultrasound_MovieGroup_001");
    if( !subds.FindDataElement( tseq_values8 ) ) return 1;
    const DataElement& seq_values8 = subds.GetDataElement( tseq_values8 );
    SmartPointer<SequenceOfItems> sqi_values8 = seq_values8.GetValueAsSQ();
    const PrivateTag tseq_values8name(0x7fe1,0x2,"GEMS_Ultrasound_MovieGroup_001");
    if( !subds.FindDataElement( tseq_values8name ) ) return 1;
    const DataElement& values8name = subds.GetDataElement( tseq_values8name );
}
Element<VR::LO,VM::VM1> el;
el.SetFromDataElement( values8name );
std::cout << el.GetValue() << std::endl;
}
size_t count = subds.Size(); (void)count;
assert( subds.Size() == 3 + 2 + 1 || subds.Size() == 3 + 2 + 2);

```

```

// (7fe1,0010) # 30,1 Private Creator
// (7fe1,1002) # 8,1 US MovieGroup Value 0008 Name
// (7fe1,1003) # 4,1 ?
// (7fe1,1008) # 8140,1 US MovieGroup Value 0008 Sequence
// (7fe1,1010) # 1372196,1 ?
// (7fe1,1070) # 33684,1 US MovieGroup Dict
// (7fe1,1073) (*)
PrintNameValueMapping( sqi_values8, sqi_dict, " ");
const PrivateTag tseq_values10(0x7fe1,0x10,"GEMS_Ultrasound_MovieGroup_001");
const PrivateTag tseq_values10name(0x7fe1,0x12,"GEMS_Ultrasound_MovieGroup_001");
const PrivateTag tseq_values18(0x7fe1,0x18,"GEMS_Ultrasound_MovieGroup_001");
PrintNameValueMapping4( tseq_values10, subds, tseq_values10name, tseq_values18, sqi_dict, " ");
print73( subds, sqi_dict, " " );
#if 0
gdcm::DataSet::ConstIterator it = subds.Begin();
for( ; it != subds.End(); ++it )
{
const gdcm::DataElement &de = *it;
std::cout << de.GetTag() << std::endl;
}
#endif
return 0;
}

```

## 12.51 DumpImageHeaderInfo.cxx

```

/*=====
Program: GDCM (Grassroots DICOM). A DICOM library

Copyright (c) 2006-2011 Mathieu Malaterre
All rights reserved.
See Copyright.txt or http://gdcm.sourceforge.net/Copyright.html for details.

This software is distributed WITHOUT ANY WARRANTY; without even
the implied warranty of MERCHANTABILITY or FITNESS FOR A PARTICULAR
PURPOSE. See the above copyright notice for more information.

=====*/
/*
 * Dump TOSHIBA MDW HEADER / Image Header Info
 */
#include "gdcmReader.h"
#include "gdcmPrivateTag.h"
#include "gdcmAttribute.h"
#include "gdcmImageWriter.h"
#include <iostream>
#include <fstream>
#include <vector>
#include <string.h>
#include <assert.h>
#include <stdint.h>
struct element
{
std::istream & read( std::istream & is );
};
std::istream & element::read( std::istream & is )
{
static const uint32_t ref = 0xe000fffe;
std::ostream &os = std::cout;
if( is.eof() )
{
return is;
}
uint32_t magic;
if( !is.read( (char*)&magic, sizeof(magic) ) )
{
return is;
}
//os << magic << std::endl;
assert( magic == ref ); (void)ref;
uint32_t l;
is.read( (char*)&l, sizeof(l) );
//os << l << std::endl;
char str[17];
str[16] = 0;
is.read( str, 16 );
}

```

```

os << str << " (" << l << ")" << std::endl;
std::vector<char> bytes;
bytes.resize( l - 16 );
if( !bytes.empty() )
{
    is.read( &bytes[0], l - 16 );
}
//os << "pos:" << is.tellg() << std::endl;
if( strcmp(str, "TUSREMEASUREMENT" ) == 0 )
{
    const char *p = &bytes[0];
    uint32_t val;
    memcpy( (char*)&val, p, sizeof(val) );
    os << " " << val << std::endl;
    p += sizeof(val);
    memcpy( (char*)&val, p, sizeof(val) );
    os << " " << val << std::endl;
    p += sizeof(val);
    memcpy( (char*)&val, p, sizeof(val) );
    os << " " << val << std::endl;
    p += sizeof(val);
    memcpy( (char*)&val, p, sizeof(val) );
    os << " " << val << std::endl;
    p += sizeof(val);
    memcpy( (char*)&val, p, sizeof(val) );
    os << " " << val << std::endl;
    p += sizeof(val);
    memcpy( (char*)&val, p, sizeof(val) );
    os << " " << val << std::endl;
    p += sizeof(val);
    memcpy( (char*)&val, p, sizeof(val) );
    os << " " << val << std::endl;
    p += sizeof(val);
}
#if 0
float f;
memcpy( (char*)&f, p, sizeof(f) );
os << " " << f << std::endl;
p += sizeof(f);
#else
memcpy( (char*)&val, p, sizeof(val) );
os << " " << val << std::endl;
p += sizeof(val);
#endif
memcpy( (char*)&val, p, sizeof(val) );
os << " " << val << std::endl;
p += sizeof(val);
char str2[17];
memcpy( str2, p, 16 );
str2[16] = 0;
os << " " << str2 << std::endl;
}
#if 0
std::ofstream out( str, std::ios::binary );
out.write( (char*)&magic, sizeof( magic ) );
out.write( (char*)&l, sizeof( l ) );
out.write( str, 16 );
out.write( &bytes[0], bytes.size() );
#endif
return is;
}
static bool DumpImageHeaderInfo( std::istream & is, size_t reflen )
{
    // TUSNONIMAGESTAM (5176)
    // TUSREMEASUREMEN (1352)
    // TUSBSINGLELAYOU (16)
    // TUSCLIPPAREMETE (104)
    element el;
    while( el.read( is ) )
    {
    }
    //size_t pos = is.tellg();
    //assert( pos == reflen );
    (void)reflen;
    return true;
}
int main(int argc, char *argv[])
{
    if( argc < 2 ) return 1;
    const char *filename = argv[1];
    gdcm::Reader reader;
    reader.SetFileName( filename );
    if( !reader.Read() )
    {
        std::cerr << "Failed to read: " << filename << std::endl;
    }
}

```

```

    return 1;
}
const gdcm::DataSet& ds = reader.GetFile().GetDataSet();
const gdcm::PrivateTag timageheaderinfo(0x0029,0x10,"TOSHIBA MDW HEADER");
if( !ds.FindElement( timageheaderinfo ) ) return 1;
const gdcm::DataElement& imageheaderinfo = ds.GetDataElement( timageheaderinfo );
if ( imageheaderinfo.IsEmpty() ) return 1;
const gdcm::ByteValue * bv = imageheaderinfo.GetByteValue();
std::istream is;
std::string dup( bv->GetPointer(), bv->GetLength() );
is.str( dup );
bool b = DumpImageHeaderInfo( is, bv->GetLength() );
if( !b ) return 1;
#if 0
const float d1 = 0.0041666668839752674; // 89 88 88 3B // 0x44c
//const float d1 = 0.053231674455417881;
const float d2 = 0.10828025639057159; // 0A C2 DD 3D // 0x1ac
//const float d1 = 0.17869562069272813;
//const unsigned int d2 = 4294967280;
const float d3 = 0.10828025639057159; // 0A C2 DD 3D // 0x15c
const int32_t d4 = 134;
const uint32_t d5 = 1153476;
std::ofstream t("/tmp/debug", std::ios::binary );
//t.write( (char*)&d0, sizeof( d0 ) );
t.write( (char*)&d1, sizeof( d1 ) );
t.write( (char*)&d2, sizeof( d2 ) );
t.write( (char*)&d3, sizeof( d3 ) );
t.write( (char*)&d4, sizeof( d4 ) );
t.write( (char*)&d5, sizeof( d5 ) );
t.close();
#endif
return 0;
}

```

## 12.52 DumpPhilipsECHO.cxx

```

/*=====
Program: GDCM (Grassroots DICOM). A DICOM library

Copyright (c) 2006-2011 Mathieu Malaterre
All rights reserved.
See Copyright.txt or http://gdcm.sourceforge.net/Copyright.html for details.

This software is distributed WITHOUT ANY WARRANTY; without even
the implied warranty of MERCHANTABILITY or FITNESS FOR A PARTICULAR
PURPOSE. See the above copyright notice for more information.

=====*/
#include "gdcmReader.h"
#include "gdcmDeflateStream.h"
#include "gdcm_zlib.h"
/*
 * This example extract the ZLIB compressed US image from a Philips private tag
 *
 * Everything done in this code is for the sole purpose of writing interoperable
 * software under Sect. 1201 (f) Reverse Engineering exception of the DMCA.
 * If you believe anything in this code violates any law or any of your rights,
 * please contact us (gdcm-developers@lists.sourceforge.net) so that we can
 * find a solution.
 *
 * Everything you do with this code is at your own risk, since decompression
 * algorithm was not written from specification documents.
 *
 * Usage:
 *
 * $ DumpPhilipsECHO private_us.dcm raw_us_img.raw
 * $ gdcming --sop-class-uid 1.2.840.10008.5.1.4.1.1.3.1 --size 608,427,88 raw_us_img.raw raw_us_img.dcm
 */
// header:
struct hframe
{
    uint32_t val0; // 800 increment ?
    uint16_t val1[2];
    uint16_t val2[2];
    uint32_t imgsize;
    bool operator==(const hframe &h) const

```

```

    {
        return val0 == h.val0 &&
            val1[0] == h.val1[0] &&
            val1[1] == h.val1[1] &&
            val2[0] == h.val2[0] &&
            val2[1] == h.val2[1] &&
            imgsize == h.imgsize;
    }
};
static bool ProcessDeflate( const char *outfilename, const int nslices, const
    int buf_size, const char *buf, const std::streampos len,
    const char *crdbuf, const size_t crclen )
{
    std::vector< hframe > crchheaders;
    crchheaders.reserve( nslices );
    {
        std::istringstream is;
        is.str( std::string( crdbuf, crclen ) );
        hframe header;
        for( int r = 0; r < nslices; ++r )
        {
            is.read( (char*)&header, sizeof( header ) );
#ifdef 0
            std::cout << header.val0
                << " " << header.val1[0]
                << " " << header.val1[1]
                << " " << header.val2[0]
                << " " << header.val2[1]
                << " " << header.imgsize << std::endl;
#endif
            crchheaders.push_back( header );
        }
        std::istringstream is;
        is.str( std::string( buf, (size_t)len ) );
        std::streamoff totalsize;
        is.read( (char*)&totalsize, sizeof( totalsize ) );
        assert( totalsize == len );
        uint32_t nframes;
        is.read( (char*)&nframes, sizeof( nframes ) );
        assert( nframes == (uint32_t)nslices );
        std::vector< std::streamoff > offsets;
        offsets.reserve( nframes );
        for( uint32_t frame = 0; frame < nframes ; ++frame )
        {
            uint32_t offset;
            is.read( (char*)&offset, sizeof( offset ) );
            offsets.push_back( offset );
        }
        std::vector<char> outbuf;
        const int size[2] = { 608, 427 }; // FIXME: where does it comes from ?
        std::stringstream ss;
        ss << outfile;
        ss << '_';
        //ss << crchheaders[0].imgsize; // FIXME: Assume all header are identical !
        ss << size[0];
        ss << '_';
        ss << size[1];
        ss << '_';
        ss << nframes;
        ss << ".raw";
        std::ofstream os( ss.str().c_str(), std::ios::binary );
        assert( buf_size >= size[0] * size[1] );
        outbuf.resize( buf_size );
        hframe header;
        //uint32_t prev = 0;
        for( unsigned int r = 0; r < nframes; ++r )
        {
            is.read( (char*)&header, sizeof( header ) );
            assert( header == crchheaders[r] );
            assert( header.val1[0] == 2000 );
            assert( header.val1[1] == 3 );
            assert( header.val2[0] == 1 );
            assert( header.val2[1] == 1280 );
            uLongf destLen = buf_size; // >= 608,427
            Bytef *dest = (Bytef*)&outbuf[0];
            assert( is.tellg() == offsets[r] + 16 );
            const Bytef *source = (const Bytef*)buf + offsets[r] + 16;
            uLong sourceLen;
            if( r + 1 == nframes )
                sourceLen = (uLong)totalsize - (uLong)offsets[r] - 16;

```



```

    else
        sourceLen = (uLong)offsets[r+1] - (uLong)offsets[r] - 16;
        // FIXME: in-memory decompression:
        int ret = uncompress (dest, &destLen, source, sourceLen);
        assert( ret == Z_OK ); (void)ret;
        assert( destLen >= (uLongf)size[0] * size[1] ); // 16bytes padding ?
        assert( header.imgsize == (uint32_t)size[0] * size[1] );
        //os.write( &outbuf[0], outbuf.size() );
        os.write( &outbuf[0], size[0] * size[1] );
        // skip data:
        is.seekg( sourceLen, std::ios::cur );
    }
    os.close();
    assert( is.tellg() == totalsize );
    return true;
}

static bool ProcessNone( const char *outfilename, const int nslices, const
int buf_size, const char *buf, const std::streampos len,
const char *crdbuf, const size_t crclen )
{
    std::vector< hframe > crchheaders;
    crchheaders.reserve( nslices );
    {
        std::istringstream is;
        is.str( std::string( crdbuf, crclen ) );
        hframe header;
        for( int r = 0; r < nslices; ++r )
        {
            is.read( (char*)&header, sizeof( header ) );
        }
    }
    #if 0
        std::cout << header.val0
            << " " << header.val1[0]
            << " " << header.val1[1]
            << " " << header.val2[0]
            << " " << header.val2[1]
            << " " << header.imgsize << std::endl;
    #endif
    crchheaders.push_back( header );
    }
    std::istringstream is;
    is.str( std::string( buf, (size_t)len ) );
    std::streampos totalsize;
    is.read( (char*)&totalsize, sizeof( totalsize ) );
    assert( totalsize == len );
    uint32_t nframes;
    is.read( (char*)&nframes, sizeof( nframes ) );
    assert( nframes == (uint32_t)nslices );
    std::vector< uint32_t > offsets;
    offsets.reserve( nframes );
    for( uint32_t frame = 0; frame < nframes ; ++frame )
    {
        uint32_t offset;
        is.read( (char*)&offset, sizeof( offset ) );
        offsets.push_back( offset );
        //std::cout << offset << std::endl;
    }
    std::vector<char> outbuf;
    // No idea how to present the data, I'll just append everything, and present it as 2D
    std::stringstream ss;
    ss << outfile;
    ss << '_';
    ss << crchheaders[0].imgsize; // FIXME: Assume all header are identical !
    ss << '_';
    ss << nframes;
    ss << ".raw";
    std::ofstream os( ss.str().c_str(), std::ios::binary );
    outbuf.resize( buf_size ); // overallocated + 16
    char *buffer = &outbuf[0];
    hframe header;
    for( unsigned int r = 0; r < nframes; ++r )
    {
        is.read( (char*)&header, sizeof( header ) );
    }
    #if 0
        std::cout << header.val0
            << " " << header.val1[0]
            << " " << header.val1[1]
            << " " << header.val2[0]
            << " " << header.val2[1]
            << " " << header.imgsize << std::endl;
    #endif
}

```

```

    assert( header == crcheaders[r] );
    is.read( buffer, buf_size - 16 );
    os.write( buffer, header.imgsize );
}
assert( is.tellg() == totalsize );
os.close();
return true;
}
#endif
#ifdef NDEBUG
static const char * const UDM_USD_DATATYPE_STRINGS[] = {
    "UDM_USD_DATATYPE_DIN_2D_ECHO",
    "UDM_USD_DATATYPE_DIN_2D_ECHO_CONTRAST",
    "UDM_USD_DATATYPE_DIN_DOPPLER_CW",
    "UDM_USD_DATATYPE_DIN_DOPPLER_PW",
    "UDM_USD_DATATYPE_DIN_DOPPLER_PW_TDI",
    "UDM_USD_DATATYPE_DIN_2D_COLOR_FLOW",
    "UDM_USD_DATATYPE_DIN_2D_COLOR_PMI",
    "UDM_USD_DATATYPE_DIN_2D_COLOR_CPA",
    "UDM_USD_DATATYPE_DIN_2D_COLOR_TDI",
    "UDM_USD_DATATYPE_DIN_MMODE_ECHO",
    "UDM_USD_DATATYPE_DIN_MMODE_COLOR",
    "UDM_USD_DATATYPE_DIN_MMODE_COLOR_TDI",
    "UDM_USD_DATATYPE_DIN_PARAM_BLOCK",
    "UDM_USD_DATATYPE_DIN_2D_COLOR_VELOCITY",
    "UDM_USD_DATATYPE_DIN_2D_COLOR_POWER",
    "UDM_USD_DATATYPE_DIN_2D_COLOR_VARIANCE",
    "UDM_USD_DATATYPE_DIN_DOPPLER_AUDIO",
    "UDM_USD_DATATYPE_DIN_DOPPLER_HIGHQ",
    "UDM_USD_DATATYPE_DIN_PHYSIO",
    "UDM_USD_DATATYPE_DIN_2D_COLOR_STRAIN",
    "UDM_USD_DATATYPE_DIN_COMPOSITE_RGB",
    "UDM_USD_DATATYPE_DIN_XFOV_REALTIME_GRAPHICS",
    "UDM_USD_DATATYPE_DIN_XFOV_MOSAIC",
    "UDM_USD_DATATYPE_DIN_COMPOSITE_R",
    "UDM_USD_DATATYPE_DIN_COMPOSITE_G",
    "UDM_USD_DATATYPE_DIN_COMPOSITE_B",
    "UDM_USD_DATATYPE_DIN_MMODE_COLOR_VELOCITY",
    "UDM_USD_DATATYPE_DIN_MMODE_COLOR_POWER",
    "UDM_USD_DATATYPE_DIN_MMODE_COLOR_VARIANCE",
    "UDM_USD_DATATYPE_DIN_2D_ELASTO",
};
static inline bool is_valid( const char * datatype_str )
{
    static const int n = sizeof( UDM_USD_DATATYPE_STRINGS ) / sizeof( *UDM_USD_DATATYPE_STRINGS );
    bool found = false;
    if( datatype_str )
    {
        for( int i = 0; !found && i < n; ++i )
        {
            found = strcmp( datatype_str, UDM_USD_DATATYPE_STRINGS[i] ) == 0;
        }
    }
    return found;
}
#endif
int main(int argc, char *argv[])
{
    if( argc < 2 ) return 1;
    using namespace gdcm;
    const char *filename = argv[1];
    gdcm::Reader reader;
    reader.SetFileName( filename );
    if( !reader.Read() ) return 1;
    gdcm::File &file = reader.GetFile();
    gdcm::DataSet &ds1 = file.GetDataSet();
    const PrivateTag tseq1(0x200d,0x3cf8,"Philips US Imaging DD 045");
    if( !ds1.FindDataElement( tseq1 ) ) return 1;
    const DataElement& seq1 = ds1.GetDataElement( tseq1 );
    SmartPointer<SequenceOfItems> sq1 = seq1.GetValueAsSQ();
    assert( sq1->GetNumberOfItems() >= 1 );
    const size_t nitems = sq1->GetNumberOfItems();
    for( size_t item = 1; item < nitems; ++item )
    {
        Item &item1 = sq1->GetItem(item);
        DataSet &ds2 = item1.GetNestedDataSet();
        // (200d,300d) LO 28 UDM_USD_DATATYPE_DIN_2D_ECHO
        const PrivateTag tdatatype(0x200d,0x300d,"Philips US Imaging DD 033");
        if( !ds2.FindDataElement( tdatatype ) ) return 1;
        const DataElement& datatype = ds2.GetDataElement( tdatatype );
        const ByteValue *bvdatatype = datatype.GetByteValue();
        if( !bvdatatype ) return 1;
    }
}

```

```

const PrivateTag tseq2(0x200d,0x3cf1,"Philips US Imaging DD 045");
if( !ds2.FindDataElement( tseq2 ) ) return 1;
const DataElement& seq2 = ds2.GetDataElement( tseq2 );
SmartPointer<SequenceOfItems> sqi2 = seq2.GetValueAsSQ();
assert( sqi2->GetNumberOfItems() >= 1 );
// FIXME: what if not in first Item ?
assert( sqi2->GetNumberOfItems() == 1 );
Item &item2 = sqi2->GetItem(1);
DataSet &ds3 = item2.GetNestedDataSet();
const PrivateTag tzlib(0x200d,0x3cfa,"Philips US Imaging DD 045");
if( !ds3.FindDataElement( tzlib ) ) return 1;
const DataElement& zlib = ds3.GetDataElement( tzlib );
const ByteValue *bv = zlib.GetByteValue();
if( !bv ) return 1;
if( bv->GetLength() != 4 ) return 1;
// (200d,3010) IS 2 88
const PrivateTag tnslices(0x200d,0x3010,"Philips US Imaging DD 033");
if( !ds3.FindDataElement( tnslices ) ) return 1;
const DataElement& nslices = ds3.GetDataElement( tnslices );
Element<VR::IS,VM::VM1> elnslices;
elnslices.SetFromDataElement( nslices );
const int nslicesref = elnslices.GetValue();
assert( nslicesref >= 0 );
// (200d,3011) IS 6 259648
const PrivateTag tzalloc(0x200d,0x3011,"Philips US Imaging DD 033");
if( !ds3.FindDataElement( tzalloc ) ) return 1;
const DataElement& zalloc = ds3.GetDataElement( tzalloc );
Element<VR::IS,VM::VM1> elzalloc;
elzalloc.SetFromDataElement( zalloc );
const int zallocref = elzalloc.GetValue();
assert( zallocref >= 0 );
// (200d,3021) IS 2 0
const PrivateTag tzzero(0x200d,0x3021,"Philips US Imaging DD 033");
if( !ds3.FindDataElement( tzzero ) ) return 1;
const DataElement& zero = ds3.GetDataElement( tzzero );
Element<VR::IS,VM::VM1> elzero;
elzero.SetFromDataElement( zero );
const int zerocref = elzero.GetValue();
assert( zerocref == 0 ); (void)zerocref;
// (200d,3cf3) OB
const PrivateTag tdeflate(0x200d,0x3cf3,"Philips US Imaging DD 045");
if( !ds3.FindDataElement( tdeflate ) ) return 1;
const DataElement& deflate = ds3.GetDataElement( tdeflate );
const ByteValue *bv2 = deflate.GetByteValue();
// (200d,3cfb) OB
const PrivateTag tcrc(0x200d,0x3cfb,"Philips US Imaging DD 045");
if( !ds3.FindDataElement( tcrc ) ) return 1;
const DataElement& crc = ds3.GetDataElement( tcrc );
const ByteValue *bv3 = crc.GetByteValue();
std::string outfile = std::string( bvdatatype->GetPointer(), bvdatatype->GetLength() );
outfile = LOComp::Trim( outfile.c_str() );
const char *outfilename = outfile.c_str();
assert( is_valid(outfilename) );
if( bv2 )
{
    assert( bv3 );
    assert( zallocref > 0 );
    assert( nslicesref > 0 );
    std::cout << ds2 << std::endl;
    if( strncmp(bv->GetPointer(), "ZLib", 4) == 0 )
    {
        if( !ProcessDeflate( outfile, nslicesref, zallocref, bv2->GetPointer(),
            std::streampos( bv2->GetLength(), bv3->GetPointer(), bv3->GetLength() ) ) )
        {
            return 1;
        }
    }
    else if( strncmp(bv->GetPointer(), "None", 4) == 0 )
    {
        if( !ProcessNone( outfile, nslicesref, zallocref, bv2->GetPointer(),
            std::streampos( bv2->GetLength(), bv3->GetPointer(), bv3->GetLength() ) ) )
        {
            return 1;
        }
    }
    else
    {
        std::string str( bv->GetPointer(), bv->GetLength() );
        std::cerr << "Unhandled: " << str << std::endl;
        return 1;
    }
}

```

```

    }
}
return 0;
}

```

## 12.53 DumpSiemensBase64.cxx

```

/*=====
Program: GDCM (Grassroots DICOM). A DICOM library

Copyright (c) 2006-2011 Mathieu Malaterre
All rights reserved.
See Copyright.txt or http://gdcml.sourceforge.net/Copyright.html for details.

This software is distributed WITHOUT ANY WARRANTY; without even
the implied warranty of MERCHANTABILITY or FITNESS FOR A PARTICULAR
PURPOSE. See the above copyright notice for more information.

=====*/
/*
 * https://groups.google.com/forum/#!msg/comp.protocols.dicom/2kZ21LP8Ecm/WzjFrtjnAgAJ
 */
#include "gdcmlReader.h"
#include "gdcmlPrivateTag.h"
#include "gdcmlPrinter.h"
#include "gdcmlDictPrinter.h"
#include "gdcmlCSAHeader.h"
#include "gdcmlBase64.h"
#include "gdcmlExplicitDataElement.h"
#include "gdcmlSwapper.h"
#include "gdcmlPrinter.h"
#include <iostream>
#include <fstream>
#include <vector>
#include <assert.h>
int main(int argc, char *argv[])
{
    if( argc < 2 ) return 1;
    const char *filename = argv[1];
    gdcml::Reader reader;
    reader.SetFileName( filename );
    if( !reader.Read() )
    {
        std::cerr << "Failed to read: " << filename << std::endl;
        return 1;
    }
    const gdcml::DataSet& ds = reader.GetFile().GetDataSet();
    gdcml::CSAHeader csa;
    const gdcml::PrivateTag &t1 = csa.GetCSAImageHeaderInfoTag();
    if( !ds.FindDataElement( t1 ) ) return 1;
    csa.LoadFromDataElement( ds.GetDataElement( t1 ) );
    //const char name[] = "MRDiffusion";
    const char name[] = "MR_AS1";
    if( csa.FindCSAElementByName( name ) )
    {
        const gdcml::CSAElement &e1 = csa.GetCSAElementByName( name );
        const gdcml::ByteValue* bv = e1.GetByteValue();
        std::string str( bv->GetPointer(), bv->GetLength() );
        str.erase( std::remove( str.begin(), str.end(), '\n' ), str.end() );
        size_t dl = gdcml::Base64::GetDecodeLength( str.c_str(), str.size() );
        std::vector<char> buf;
        buf.resize( dl );
        size_t dl2 = gdcml::Base64::Decode( &buf[0], buf.size(), str.c_str(), str.size() );
        (void)dl2;
        std::stringstream ss;
        ss.str( std::string( &buf[0], buf.size() ) );
        gdcml::File file;
        gdcml::DataSet &ds2 = file.GetDataSet();
        gdcml::DataElement xde;
        try
        {
            while( xde.Read<gdcml::ExplicitDataElement, gdcml::SwapperNoOp>( ss ) )
            {
                ds2.Insert( xde );
            }
            assert( ss.eof() );
        }
    }
}

```

```

    }
    catch(std::exception &)
    {
        return 1;
    }
    gdcM::Printer p;
    p.SetFile( file );
    p.Print(std::cout);
}
return 0;
}

```

## 12.54 DumpToSQLITE3.cxx

```

/*=====
Program: GDCM (Grassroots DICOM). A DICOM library

Copyright (c) 2006-2011 Mathieu Malaterre
All rights reserved.
See Copyright.txt or http://gdcM.sourceforge.net/Copyright.html for details.

This software is distributed WITHOUT ANY WARRANTY; without even
the implied warranty of MERCHANTABILITY or FITNESS FOR A PARTICULAR
PURPOSE. See the above copyright notice for more information.

=====*/
/*
 * Ref:
 * http://massmail.spl.harvard.edu/public-archives/slicer-devel/2010/004408.html
 *
 * Implementation details:
 * http://www.sqlite.org/c3ref/bind_blob.html
 * http://www.adp-gmbh.ch/sqlite/bind_insert.html
 */
#include "gdcMScanner.h"
#include "gdcMDirectory.h"
#include "gdcMTag.h"
#include "gdcMTrace.h"
#include "sqlite3.h"
#include <stdio.h>
#include <time.h>
int main(int argc, char *argv[])
{
    if( argc < 2 )
    {
        return 1;
    }
    time_t time_start = time(nullptr);
    gdcM::Trace::SetDebug( false );
    gdcM::Trace::SetWarning( false );
    const char *inputdirectory = argv[1];
    gdcM::Directory d;
    unsigned int nfiles = d.Load( inputdirectory, true);
    gdcM::Scanner s;
    using gdcM::Tag;
    s.AddTag( Tag(0x20,0xd) ); // Study Instance UID
    s.AddTag( Tag(0x20,0xe) ); // Series Instance UID
    bool b0 = s.Scan( d.GetFilesNames() );
    if( !b0 ) return 1;
    time_t time_scanner = time(nullptr);
    std::cout << "Finished loading data from : " << nfiles << " files" << std::endl;
    // MappingType const &mappings = s.GetMappings();
    sqlite3* db;
    sqlite3_open("./dicom.db", &db);
    if(db == nullptr)
    {
        std::cerr << "Could not open database." << std::endl;
        return 1;
    }
    const char sql_stmt[] = "create table browser (seriesuid, studyuid)";
    int ret;
    char *errmsg;
    ret = sqlite3_exec(db, sql_stmt, nullptr, nullptr, &errmsg);
    if(ret != SQLITE_OK)
    {
        printf("Error in statement: %s [%s].\n", sql_stmt, errmsg);
    }
}

```

```

    return 1;
}
using gdcM::Directory;
using gdcM::Scanner;
const Directory::FileNamesType& files = d.GetFilesNames();
Directory::FileNamesType::const_iterator file = files.begin();
sqlite3_stmt *stmt;
if ( sqlite3_prepare(
    db,
    "insert into browser values (?,?)", // stmt
    -1, // If than zero, then stmt is read up to the first nul terminator
    &stmt,
    nullptr // Pointer to unused portion of stmt
)
    != SQLITE_OK)
{
    printf("\nCould not prepare statement.");
    return 1;
}
//printf("\nThe statement has %d wildcards\n", sqlite3_bind_parameter_count(stmt));
for(; file != files.end(); ++file)
{
    const char *filename = file->c_str();
    bool b = s.IsKey(filename);
    if( b )
    {
        const Scanner::TagToValue &mapping = s.GetMapping(filename);
        Scanner::TagToValue::const_iterator it = mapping.begin();
        sqlite3_reset(stmt);
        for( int index = 1; it != mapping.end(); ++it, ++index)
        {
            //const Tag & tag = it->first;
            const char *value = it->second;
            if (sqlite3_bind_text (
                stmt,
                index, // Index of wildcard
                value,
                (int)strlen(value), // length of text
                SQLITE_STATIC // SQLite assumes that the information is in static
            )
                != SQLITE_OK)
            {
                printf("\nCould not bind int.\n");
                return 1;
            }
        }
        if (sqlite3_step(stmt) != SQLITE_DONE)
        {
            printf("\nCould not step (execute) stmt.\n");
            return 1;
        }
    }
}
sqlite3_close(db);
time_t time_sqlite = time(nullptr);
std::cout << "Time to scan DICOM files: " << (time_scanner - time_start) << std::endl;
std::cout << "Time to build SQLITE3: " << (time_sqlite - time_scanner) << std::endl;
return 0;
}

```

## 12.55 DumpToshibaDTI.cxx

```

/*=====
Program: GDCM (Grassroots DICOM). A DICOM library

Copyright (c) 2006-2011 Mathieu Malaterre
All rights reserved.
See Copyright.txt or http://gdcM.sourceforge.net/Copyright.html for details.

This software is distributed WITHOUT ANY WARRANTY; without even
the implied warranty of MERCHANTABILITY or FITNESS FOR A PARTICULAR
PURPOSE. See the above copyright notice for more information.

=====*/
/*
* https://groups.google.com/d/msg/comp.protocols.dicom/7IaIkT0ZG5U/k7LPu81VvAMJ

```

```

*/
#include "gdcMReader.h"
#include "gdcMPrivateTag.h"
#include "gdcMPrinter.h"
#include "gdcMDictPrinter.h"
#include <iostream>
#include <fstream>
#include <vector>
#include <assert.h>
static bool DumpToshibaDTI( const char * input, size_t len )
{
    static int i = 0;
    ++i;
    if( len % 2 ) return false;
    std::vector<char> copy( input, input + len );
    std::reverse( copy.begin(), copy.end() );
    if 0
    {
        std::ostringstream f;
        f << "debug" << i;
        std::ofstream of( f.str().c_str(), std::ios::binary );
        of.write( &copy[0], copy.size() );
        of.close();
    }
    else
    {
        std::istringstream is;
        std::string dup( &copy[0], copy.size() );
        is.str( dup );
        gdcM::File file;
        gdcM::FileMetaInformation & fmi = file.GetHeader();
        fmi.SetDataSetTransferSyntax( gdcM::TransferSyntax::ExplicitVRLittleEndian );
        gdcM::DataSet & ds = file.GetDataSet();
        ds.Read<gdcM::ExplicitDataElement, gdcM::SwapperNoOp>( is );
        //gdcM::DictPrinter p;
        gdcM::Printer p;
        p.SetFile( file );
        p.SetColor( true );
        p.Print( std::cout );
    }
    return true;
}
int main(int argc, char *argv[])
{
    if( argc < 2 ) return 1;
    const char *filename = argv[1];
    gdcM::Reader reader;
    reader.SetFileName( filename );
    if( !reader.Read() )
    {
        std::cerr << "Failed to read: " << filename << std::endl;
        return 1;
    }
    const gdcM::DataSet& ds = reader.GetFile().GetDataSet();
    // (0029,0010) ?? (LO) [PMTF INFORMATION DATA ] # 22,1 Private Creator
    // (0029,1001) ?? (SQ) (Sequence with undefined length) # u/1,1 ?
    const gdcM::PrivateTag tpmtf(0x0029,0x1,"PMTF INFORMATION DATA");
    if( !ds.FindDataElement( tpmtf ) ) return 1;
    const gdcM::DataElement& pmtf = ds.GetDataElement( tpmtf );
    if ( pmtf.IsEmpty() ) return 1;
    gdcM::SmartPointer<gdcM::SequenceOfItems> seq = pmtf.GetValueAsSQ();
    if ( !seq || !seq->GetNumberOfItems() ) return 1;
    size_t n = seq->GetNumberOfItems();
    for( size_t i = 1; i <= n; ++i )
    {
        gdcM::Item &item = seq->GetItem(i);
        gdcM::DataSet &subs = item.GetNestedDataSet();
        // (0029,0010) ?? (LO) [PMTF INFORMATION DATA ] # 22,1 Private Creator
        // (0029,1090) ?? (OB) 00\05\00\13\00\12\00\22\ # 202,1 ?
        const gdcM::PrivateTag tseq(0x0029,0x90,"PMTF INFORMATION DATA");
        if( subs.FindDataElement( tseq ) )
        {
            const gdcM::DataElement &de = subs.GetDataElement( tseq );
            const gdcM::ByteValue *bv = de.GetByteValue();
            if( !bv ) return 1;
            bool b = DumpToshibaDTI( bv->GetPointer(), bv->GetLength() );
            if( !b ) return 1;
        }
    }
    return 0;
}

```

## 12.56 DumpToshibaDTI2.cxx

```

/*=====
Program: GDCM (Grassroots DICOM). A DICOM library

Copyright (c) 2006-2011 Mathieu Malaterre
All rights reserved.
See Copyright.txt or http://gdcm.sourceforge.net/Copyright.html for details.

This software is distributed WITHOUT ANY WARRANTY; without even
the implied warranty of MERCHANTABILITY or FITNESS FOR A PARTICULAR
PURPOSE. See the above copyright notice for more information.
=====*/
/*
 *
 *      https://gazelle.ihe.net/EVSCClient/dicomResult.seam;jsessionid=x+Rf9Zs+ip49P+jC3L8SLZb8?&oid=1.3.6.1.4.1.12559.11.1.2.1.4.1
 */
#include "gdcmReader.h"
#include "gdcmPrivateTag.h"
#include "gdcmPrinter.h"
#include "gdcmDictPrinter.h"
#include <iostream>
#include <fstream>
#include <vector>
#include <assert.h>
static bool DumpToshibaDTI2( const char * input, size_t len )
{
    static int i = 0;
    ++i;
    if( len % 2 ) return false;
    std::vector<char> copy( input, input + len );
    std::reverse( copy.begin(), copy.end() );
#if 0
    std::ostringstream f;
    f << "debug" << i;
    std::ofstream( f.str().c_str(), std::ios::binary );
    of.write( &copy[0], copy.size() );
    of.close();
#else
    std::istringstream is;
    std::string dup( &copy[0], copy.size() );
    is.str( dup );
    gdcm::File file;
    gdcm::FileMetaInformation & fmi = file.GetHeader();
    fmi.SetDataSetTransferSyntax( gdcm::TransferSyntax::ExplicitVRLittleEndian );
    gdcm::DataSet & ds = file.GetDataSet();
    ds.Read<gdcm::ExplicitDataElement, gdcm::SwapperNoOp>( is );
    //gdcm::DictPrinter p;
    gdcm::Printer p;
    p.SetFile( file );
    p.SetColor( true );
    p.Print( std::cout );
#endif
    return true;
}
int main(int argc, char *argv[])
{
    if( argc < 2 ) return 1;
    const char *filename = argv[1];
    gdcm::Reader reader;
    reader.SetFileName( filename );
    if( !reader.Read() )
    {
        std::cerr << "Failed to read: " << filename << std::endl;
        return 1;
    }
    const gdcm::DataSet& ds = reader.GetFile().GetDataSet();
    /*
(0029,1001) SQ (Sequence with explicit length #=6)          # 18746, 1 Unknown Tag & Data
  (ffe,e000) na (Item with explicit length #=2)            # 206, 1 Item
    (0029,0010) LO [TOSHIBA_MEC_MR3]                       # 16, 1 PrivateCreator
    (0029,1090) OB 00\07\00\06\00\05\00\04\00\03\00\02\00\0c\00\01\00\00\00\00\00\12... # 170, 1 Unknown Tag &
    Data
  (ffe,e00d) na (ItemDelimitationItem for re-encoding)    # 0, 0 ItemDelimitationItem
  (ffe,e000) na (Item with explicit length #=2)            # 866, 1 Item
    (0029,0010) LO [TOSHIBA_MEC_MR3]                       # 16, 1 PrivateCreator
    (0029,1090) OB 45\4e\49\50\53\4c\20\52\41\5c\45\4e\49\50\53\4c\54\5c\52\45\53\55... # 830, 1 Unknown Tag &
    Data
    */
}

```



```
[...]
(0029,1002) SQ (Sequence with explicit length #=1) # 120, 1 Unknown Tag & Data
  (fffe,e000) na (Item with explicit length #=2) # 112, 1 Item
    (0029,0010) LO [TOSHIBA_MEC_MR3] # 16, 1 PrivateCreator
    (0029,1090) OB 00\10\00\02\53\55\10\80\70\0d\30\31\5e\33\52\4d\5f\43\45\4d\5f\41... # 76, 1 Unknown Tag &
      Data
    (fffe,e00d) na (ItemDelimitationItem for re-encoding) # 0, 0 ItemDelimitationItem
  */
const gdcm::PrivateTag tmecmr3(0x0029,0x1,"TOSHIBA_MEC_MR3");
if( !ds.FindDataElement( tmecmr3 ) ) return 1;
const gdcm::DataElement& mecmr3 = ds.GetDataElement( tmecmr3 );
if ( mecmr3.IsEmpty() ) return 1;
gdcm::SmartPointer<gdcm::SequenceOfItems> seq = mecmr3.GetValueAsSQ();
if ( !seq || !seq->GetNumberOfItems() ) return 1;
size_t n = seq->GetNumberOfItems();
for( size_t i = 1; i <= n; ++i )
{
  gdcm::Item &item = seq->GetItem(i);
  gdcm::DataSet &subds = item.GetNestedDataSet();
  const gdcm::PrivateTag tseq(0x0029,0x90,"TOSHIBA_MEC_MR3");
  if( subds.FindDataElement( tseq ) )
  {
    const gdcm::DataElement & de = subds.GetDataElement( tseq );
    const gdcm::ByteValue * bv = de.GetByteValue();
    if( !bv ) return 1;
    bool b = DumpToshibaDTI2( bv->GetPointer(), bv->GetLength() );
    if( !b ) return 1;
  }
}
return 0;
}
```

## 12.57 DumpVisusChange.cxx

```
/*=====
Program: GDCM (Grassroots DICOM). A DICOM library

Copyright (c) 2006-2011 Mathieu Malaterre
All rights reserved.
See Copyright.txt or http://gdcm.sourceforge.net/Copyright.html for details.

This software is distributed WITHOUT ANY WARRANTY; without even
the implied warranty of MERCHANTABILITY or FITNESS FOR A PARTICULAR
PURPOSE. See the above copyright notice for more information.

=====*/
#include "gdcmReader.h"
#include "gdcmDirectory.h"
#include "gdcmStringFilter.h"
#include <vector>
#include <algorithm>
/*
*/
static bool process( std::vector<gdcm::DataElement> & ms, const char * filename)
{
  using namespace gdcm;
  Tag pd(0x7fe0,0x0000);
  std::set<gdcm::Tag> skiptags;
  skiptags.insert( pd );
  gdcm::Reader reader;
  reader.SetFileName( filename );
  if( !reader.ReadUpToTag( pd, skiptags ) )
  {
    std::cerr << "Failure to read: " << filename << std::endl;
    return false;
  }
  gdcm::File &file = reader.GetFile();
  gdcm::DataSet &ds1 = file.GetDataSet();
  const gdcm::PrivateTag tseq1(0x5533,0x33,"Visus Change");
  if( !ds1.FindDataElement( tseq1 ) ) return true;
  const gdcm::DataElement& seq1 = ds1.GetDataElement( tseq1 );
  SmartPointer<SequenceOfItems> sqil = seq1.GetValueAsSQ();
  const size_t nitems = sqil->GetNumberOfItems();
  for( size_t item = 1; item < nitems; ++item )
  {
    Item &item1 = sqil->GetItem(item);
  }
}
```

```

    DataSet &ds2 = item1.GetNestedDataSet();
    for(DataSet::ConstIterator it = ds2.Begin(); it != ds2.End(); ++it )
    {
        DataElement const & de = *it;
        // cannot simply use std::set here, see there is a discrepancy in between
        // operator== and operator<.
        // So only use operator== here:
        std::vector<DataElement>::iterator vit = std::find(ms.begin(), ms.end(), de);
        if( vit == ms.end() )
            ms.push_back(de);
    }
}
return true;
}
int main(int argc, char *argv[])
{
    bool usefastpath = true;
    if( argc < 2 ) return 1;
    using namespace gdcm;
    const char *filename = argv[1];
    gdcm::Directory::FileNamesType filenames;
    if( !gdcm::System::FileExists(filename) )
    {
        std::cerr << "Could not find file: " << filename << std::endl;
        return 1;
    }
    gdcm::Directory dir;
    if( gdcm::System::FileIsDirectory(filename) )
    {
        unsigned int nfiles = dir.Load(filename, false);
        if( nfiles == 0 )
        {
            std::cerr << "Could not find files: " << filename << std::endl;
            return 1;
        }
        filenames = dir.GetFilesNames();
    }
    else
    {
        filenames.push_back( filename );
    }
    gdcm::StringFilter sf;
    Tag pd(0x7fe0,0x0000);
    std::set<gdcm::Tag> skiptags;
    skiptags.insert( pd );
    gdcm::Reader reader;
    reader.SetFileName( filenames[0].c_str() );
    if( !reader.ReadUpToTag( pd, skiptags ) )
    {
        std::cerr << "Could not read file: " << filename << std::endl;
        return 1;
    }
    gdcm::File &file = reader.GetFile();
    sf.SetFile(file);
    if( usefastpath ) {
        // Heuristic, assume if private tag cannot be found in first file, skip the directory
        gdcm::DataSet &ds1 = file.GetDataSet();
        const gdcm::PrivateTag tseq1(0x5533,0x33,"Visus Change");
        if( !ds1.FindDataElement( tseq1 ) ){
            std::cerr << "Could not find private tag in first file skipping whole directory: " << filename << std::endl;
            return 0;
        }
    }
}

std::vector<DataElement> ms;
for(gdcm::Directory::FileNamesType::const_iterator cit = filenames.begin(); cit != filenames.end(); ++cit )
{
    if( !process(ms, cit->c_str()) ) {
        return 1;
    }
}
if( !ms.empty() ) {
    std::sort(ms.begin(), ms.end());
    std::cout << filename << ",\n";
    for(std::vector<DataElement>::const_iterator it = ms.begin(); it != ms.end(); ++it )
    {
        DataElement const & de = *it;
        std::string const & s = sf.ToString( de );
        std::cout << de.GetTag() << " " << s << std::endl;
    }
    std::cout << "\n" << std::endl;
}

```

```

}
return 0;
}

```

## 12.58 DuplicatePCDE.cxx

```

/*=====
Program: GDCM (Grassroots DICOM). A DICOM library

Copyright (c) 2006-2011 Mathieu Malaterre
All rights reserved.
See Copyright.txt or http://gdcms.sourceforge.net/Copyright.html for details.

This software is distributed WITHOUT ANY WARRANTY; without even
the implied warranty of MERCHANTABILITY or FITNESS FOR A PARTICULAR
PURPOSE. See the above copyright notice for more information.

=====*/
#include "gdcmReader.h"
#include "gdcmWriter.h"
#include "gdcmItem.h"
#include "gdcmImageReader.h"
#include "gdcmSequenceOfItems.h"
#include "gdcmFile.h"
#include "gdcmTag.h"
/*
Usage:
DuplicatePCDE gdcmData/D_CLUNIE_CT1_J2KI.dcm out.dcm

aka:
medical.nema.org/medical/dicom/DataSets/WG04/IMAGES/J2KI/CT1_J2KI

See:
gdcmConformanceTests/CT1_J2KI_DuplicatePCDE.dcm

Original thread can be found at:

http://groups.google.com/group/comp.protocols.dicom/browse_thread/thread/82f28c4db28963af

Question:
1.
There is no restriction for a specific Private Creator Data Element
(PCDE) to be unique within the same group, right ?
Decoders of Private Data would have to handle the case where a PCDE
would be repeated and should NOT stop on the first instance of a
particular PCDE, right ?

Eg. when searching for the tag associated with
(0x0029,0x0010,"SIEMENS CSA HEADER") in the following (pseudo)
dataset:

(0029,0010) LO [SIEMENS CSA HEADER] # 18, 1
PrivateCreator
(0029,0011) LO [SIEMENS MEDCOM HEADER] # 22, 1
PrivateCreator
(0029,0012) LO [SIEMENS MEDCOM HEADER2] # 22, 1
PrivateCreator
(0029,0013) LO [SIEMENS CSA HEADER] # 18, 1
PrivateCreator
(0029,1008) CS [IMAGE NUM 4] # 12, 1
CSAImageHeaderType
(0029,1009) LO [20050723] # 8, 1
CSAImageHeaderVersion
(0029,1010) OB 53\56\31\30\04\03\02\01\38\00\00\00\4d
\00\00\00\45\63\68\6f\4c\69... # 6788, 1 CSAImageHeaderInfo
(0029,1018) CS [MR] # 2, 1
CSASeriesHeaderType
(0029,1019) LO [20050723] # 8, 1
CSASeriesHeaderVersion
(0029,1020) OB 53\56\31\30\04\03\02\01\2c\00\00\00\4d
\00\00\00\55\73\65\64\50\61... # 51520, 1 CSASeriesHeaderInfo
(0029,1131) LO [4.0.163088300] # 14, 1
PMTFInformation1
(0029,1132) UL 32768 # 4, 1
PMTFInformation2

```

```
(0029,1133) UL 0 # 4, 1
PMTFInformation3
(0029,1134) CS [DB TO DICOM] # 12, 1
PMTFInformation4
(0029,1260) ?? 63\6f\6d\20 # 4, 1
Unknown Tag & Data
(0029,1310) OB 53\56\31\30\04\03\02\01\38\00\00\00\4d
\00\00\00\45\63\68\6f\4c\69... # 6788, 1 CSAImageHeaderInfo
```

one should return two instances, correct ?

Answer:

I would say that this is covered in principle by the PS 3.5 7.1 "The Data Elements ... shall occur at most once in a Data Set" rule, since the data element is defined by the tuple (private creator,gggg,ee) where xxee is the element number and xx is arbitrary and has no inherent meaning and does not serve to disambiguate the data element.

E.g.:

```
(0019,0030) Private Creator ID = "Smith"
...
(0019,0032) Private Creator ID = "Smith"
...
(0019,3015) Fractal Index = "32"
...
(0019,3215) Fractal Index = "32"
```

would be illegal because even though they are assigned different (completely arbitrary) blocks, with the same group, element number and private creator, (0019,3015) and (0019,3215) are the "same" data element.

```
*/
int main(int argc, char *argv[])
{
    if( argc < 3 )
    {
        std::cerr << argv[0] << " input.dcm output.dcm" << std::endl;
        return 1;
    }
    const char *filename = argv[1];
    const char *outfilename = argv[2];
    gdcm::Reader reader;
    reader.SetFileName( filename );
    if( !reader.Read() )
    {
        return 1;
    }
    gdcm::File &file = reader.GetFile();
    gdcm::DataSet &ds = file.GetDataSet();
    // Let's get all private element from group 0x9:
    /*
(0009,0010) LO [GEMS_IDEN_01] # 12,1 Private Creator
(0009,1001) LO [GE_GENESIS_FF ] # 14,1 Full fidelity
(0009,1002) SH [CT01] # 4,1 Suite id
(0009,1004) SH [HiSpeed CT/i] # 12,1 Product id
(0009,1027) SL 862399669 # 4,1 Image actual date
(0009,1030) SH (no value) # 0,1 Service id
(0009,1031) SH (no value) # 0,1 Mobile location number
(0009,10e6) SH [05] # 2,1 Genesis Version - now
(0009,10e7) UL 973283917 # 4,1 Exam Record checksum
(0009,10e9) SL 862399669 # 4,1 Actual series data time stamp
*/
    gdcm::Tag start(0x0009,0x0);
    // Create a temporary duplicate dataset, since we cannot insert data element as we go over them (std::set
    // would reorganize itself as we go over it ...)
    gdcm::DataSet dup;
    gdcm::Tag new_private(0x0009,0x0);
    while (start.GetGroup() == 0x9 )
    {
        const gdcm::DataElement& de = ds.FindNextDataElement(start);
        const gdcm::Tag &t = de.GetTag();
        if( t.IsPrivateCreator() )
        {
            std::cout << t << std::endl;
            // Ok let's duplicate into the next available attribute:
            gdcm::DataElement duplicate = de;
            duplicate.GetTag().SetElement( (uint16_t)(t.GetElement() + 1) );
            dup.Insert( duplicate );
        }
    }
}
```

```

    new_private = duplicate.GetTag();
}
else if( t.IsPrivate() && !t.IsPrivateCreator() )
{
    //std::cout << de << std::endl;
    std::string owner = ds.GetPrivateCreator( de.GetTag() );
    //std::cout << owner << std::endl;
    gdcm::DataElement duplicate = de;
    duplicate.GetTag().SetPrivateCreator( new_private );
    if( const gdcm::ByteValue *bv = duplicate.GetByteValue() )
    {
        // Warning: when doing : duplicate = de, only the pointer to the ByteValue is passed
        // (to avoid large memory duplicate). We need to explicitly duplicate the bytevalue ourselves:
        gdcm::ByteValue *dupbv = new gdcm::ByteValue( bv->GetPointer(),
            bv->GetLength() );
        // Let's recognize the duplicated ASCII-type elements:
        if( duplicate.GetVR() & gdcm::VR::VRASCII )
            dupbv->Fill( 'X' );
        duplicate.SetValue( *dupbv );
    }
    dup.Insert( duplicate );
}
start = t;
// move to next possible 'public' element
start.SetElement( (uint16_t)(start.GetElement() + 1) );
}
gdcm::DataSet::ConstIterator it = dup.Begin();
for( ; it != dup.End(); ++it )
{
    ds.Insert( *it );
}
gdcm::Writer w;
w.SetFile( file );
w.SetFileName( outfilename );
if ( !w.Write() )
{
    return 1;
}
return 0;
}

```

## 12.59 ELSCINT1WaveToText.cxx

```

/*=====
Program: GDCM (Grassroots DICOM). A DICOM library

Copyright (c) 2006-2011 Mathieu Malaterre
All rights reserved.
See Copyright.txt or http://gdcm.sourceforge.net/Copyright.html for details.

This software is distributed WITHOUT ANY WARRANTY; without even
the implied warranty of MERCHANTABILITY or FITNESS FOR A PARTICULAR
PURPOSE. See the above copyright notice for more information.

=====*/
#include "gdcmReader.h"
#include "gdcmPrivateTag.h"
/*
 * This example shows how to read a Wave Information tag from ELSCINT1
 * The wave information is stored in Tag (01e1,18,ELSCINT1) hidden in a
 * Secondary Capture Image Storage (usually a 'N' Symbol is shown)
 *
 * Everything done in this code is for the sole purpose of writing interoperable
 * software under Sect. 1201 (f) Reverse Engineering exception of the DMCA.
 * If you believe anything in this code violates any law or any of your rights,
 * please contact us (gdcm-developers@lists.sourceforge.net) so that we can
 * find a solution.
 *
 * Everything you do with this code is at your own risk, since decompression
 * algorithm was not written from specification documents.
 *
 * Special thanks to:
 * Gauthier Bouilhol
 */
template <typename T>
bool dumpargs(std::ostream & os, T c1, T c2, T c3, T c4, T c5, T c6, T c7, T c8)

```

```

{
    static const char sep = '\t';
    os << c1 << sep << c2 << sep << c3 << sep << c4 << sep << c5 << sep << c6 << sep << c7 << sep << c8;
    os << std::endl;
    return true;
}
bool wave2stream( std::ostream &text_file, const char *in, size_t len )
{
    const short * buffer = (const short*)in;
    size_t length = len / sizeof( short );
    text_file << "COMPLETE_WAVE" << '\t' << "MASK" << '\t' << "AQUISITION_PROFIL" << '\t' << "END-INHALE" << '\t' <<
        "END-EXHALE" << '\t' << "AQUISITION_WAVE" << '\t' << "WAVE_STATISTICS" << '\t' << "MASK" << std::endl;
    for (size_t i=0;i<length-76;i+=2)
    {
        if ( i < 74 )
        {
            if (buffer[i+75] == 0)
                text_file << buffer[i+74] << '\t' << buffer[i+75] << '\t' << 0 << '\t' << " " <<
                    '\t' << " " << '\t' << " " << '\t' << buffer[i] << '\t' << buffer[i+1] <<
                    std::endl;
            if (buffer[i+75] == 16384)
                text_file << buffer[i+74] << '\t' << buffer[i+75] << '\t' << 0 << '\t' << buffer[i+74] <<
                    '\t' << " " << '\t' << " " << '\t' << buffer[i] << '\t' << buffer[i+1] <<
                    std::endl;
            if (buffer[i+75] == 256)
                text_file << buffer[i+74] << '\t' << buffer[i+75] << '\t' << 0 << '\t' << " " <<
                    '\t' << buffer[i+74] << '\t' << " " << '\t' << buffer[i] << '\t' << buffer[i+1] <<
                    std::endl;
            if (buffer[i+75] == -32768)
                text_file << buffer[i+74] << '\t' << buffer[i+75] << '\t' << 1 << '\t' << " " <<
                    '\t' << " " << '\t' << buffer[i+74] << '\t' << buffer[i] << '\t' << buffer[i+1] <<
                    std::endl;
            if (buffer[i+75] == -16384)
                text_file << buffer[i+74] << '\t' << buffer[i+75] << '\t' << 1 << '\t' << buffer[i+74] <<
                    '\t' << " " << '\t' << buffer[i+74] << '\t' << buffer[i] << '\t' << buffer[i+1] <<
                    std::endl;
            if (buffer[i+75] == -32512)
                text_file << buffer[i+74] << '\t' << buffer[i+75] << '\t' << 1 << '\t' << " " <<
                    '\t' << buffer[i+74] << '\t' << buffer[i+74] << '\t' << buffer[i] << '\t' << buffer[i+1] <<
                    std::endl;
        }
        else
        {
            if (buffer[i+75] == 0)
                text_file << buffer[i+74] << '\t' << buffer[i+75] << '\t' << 0 << '\t' << " " <<
                    '\t' << " " << '\t' << " " << '\t' << " " << '\t' << " " <<
                    std::endl;
            if (buffer[i+75] == 16384)
                text_file << buffer[i+74] << '\t' << buffer[i+75] << '\t' << 0 << '\t' << buffer[i+74] <<
                    '\t' << " " << '\t' << " " << '\t' << " " <<
                    std::endl;
            if (buffer[i+75] == 256)
                text_file << buffer[i+74] << '\t' << buffer[i+75] << '\t' << 0 << '\t' << " " <<
                    '\t' << buffer[i+74] << '\t' << " " << '\t' << " " <<
                    std::endl;
            if (buffer[i+75] == -32768)
                text_file << buffer[i+74] << '\t' << buffer[i+75] << '\t' << 1 << '\t' << " " <<
                    '\t' << " " << '\t' << buffer[i+74] << '\t' << " " <<
                    std::endl;
            if (buffer[i+75] == -16384)
                text_file << buffer[i+74] << '\t' << buffer[i+75] << '\t' << 1 << '\t' << buffer[i+74] <<
                    '\t' << " " << '\t' << buffer[i+74] << '\t' << " " <<
                    std::endl;
            if (buffer[i+75] == -32512)
                text_file << buffer[i+74] << '\t' << buffer[i+75] << '\t' << 1 << '\t' << " " <<
                    '\t' << buffer[i+74] << '\t' << buffer[i+74] << '\t' << " " <<
                    std::endl;
        }
    }
    return true;
}
int main(int argc, char *argv [])
{
    if( argc < 3 ) return 1;
    const char *filename = argv[1];
    const char *outfilename = argv[2];
    gdcm::Reader reader;
    reader.SetFileName( filename );
    if( !reader.Read() )
    {
        std::cerr << "Failed to read: " << filename << std::endl;
    }
}

```

```

    return 1;
}
const gdcm::DataSet& ds = reader.GetFile().GetDataSet();
const gdcm::PrivateTag twave(0x01e1,0x18,"ELSCINT1");
if( !ds.FindDataElement( twave ) ) return 1;
const gdcm::DataElement& wave = ds.GetDataElement( twave );
if ( wave.IsEmpty() ) return 1;
const gdcm::ByteValue * bv = wave.GetByteValue();
assert( bv );
std::ofstream os( outfilename, std::ios::binary );
// Dump that to a CSV file:
wave2stream( os, bv->GetPointer(), bv->GetLength() );
os.close();
return 0;
}

```

## 12.60 EmptyMask.cxx

```

/*=====
Program: GDCM (Grassroots DICOM). A DICOM library

Copyright (c) 2006-2011 Mathieu Malaterre
All rights reserved.
See Copyright.txt or http://gdcm.sourceforge.net/Copyright.html for details.

This software is distributed WITHOUT ANY WARRANTY; without even
the implied warranty of MERCHANTABILITY or FITNESS FOR A PARTICULAR
PURPOSE. See the above copyright notice for more information.

=====*/
#include "gdcmEmptyMaskGenerator.h"
#include <string>
#include <cstring>
int main( int argc, char *argv[] )
{
    std::string inputdir;
    std::string outputdir;
    bool input_sopclassuid = true;
    bool grayscale_secondary_sopclassuid = false;
    if( argc < 3 ) return 1;
    inputdir = argv[1];
    outputdir = argv[2];
    // input_sopclassuid -> Use original SOP Class UID from input DICOM (Default).
    // grayscale_secondary_sopclassuid -> Use Grayscale Secondary Image Storage SOP Class UID.
    if( argc >= 3 )
    {
        input_sopclassuid = false;
        if( strcmp("input_sopclassuid", argv[3]) == 0 )
            input_sopclassuid = true;
        else if ( strcmp("grayscale_secondary_sopclassuid", argv[3]) == 0 ) {
            grayscale_secondary_sopclassuid = true;
        }
    }
    //
    gdcm::EmptyMaskGenerator emg;
    if( input_sopclassuid )
        emg.SetSOPClassUIDMode( gdcm::EmptyMaskGenerator::UseOriginalSOPClassUID );
    else if( grayscale_secondary_sopclassuid )
        emg.SetSOPClassUIDMode( gdcm::EmptyMaskGenerator::UseGrayscaleSecondaryImageStorage );
    emg.SetInputDirectory( inputdir.c_str() );
    emg.SetOutputDirectory( outputdir.c_str() );
    if( !emg.Execute() )
    {
        return 1;
    }
    return 0;
}

```

## 12.61 EncapsulateFileInRawData.cxx

```

/*=====

```

```

Program: GDCM (Grassroots DICOM). A DICOM library

Copyright (c) 2006-2011 Mathieu Malaterre
All rights reserved.
See Copyright.txt or http://gdcms.sourceforge.net/Copyright.html for details.

This software is distributed WITHOUT ANY WARRANTY; without even
the implied warranty of MERCHANTABILITY or FITNESS FOR A PARTICULAR
PURPOSE. See the above copyright notice for more information.

=====*/
#include "gdcmanonymizer.h"
#include "gdcmwriter.h"
#include "gdcmoidgenerator.h"
#include "gdcmfile.h"
#include "gdcmtag.h"
#include "gdcmsystem.h"
#include "magic.h" // libmagic, API to file command line tool
/*
 * Let say you want to encapsulate a file type that is not defined in DICOM (exe, zip, png)
 * PNG is a bad example, unless it contains transparency (which has been deprecated).
 * It will take care of dispatching each chunk to an appropriate data item (pretty much like
 * WaveformData)
 *
 * Usage:
 * ./EncapsulateFileInRawData large_input_file.exe large_input_file.dcm
 */
// TODO:
// $ file -bi /tmp/gdcm-2.1.0.pdf
int main(int argc, char *argv[])
{
    if( argc < 3 )
    {
        std::cerr << argv[0] << " inputfile output.dcm" << std::endl;
        return 1;
    }
    const char *filename = argv[1];
    const char *outfilename = argv[2];
    if( !gdcms::System::FileExists( filename ) ) return 1;
    size_t s = gdcms::System::FileSize(filename);
    if( !s ) return 1;
    magic_t cookie = magic_open(MAGIC_NONE);
    const char * file_type = magic_file(cookie, filename);
    if( !file_type ) return 1;
    magic_close(cookie);
    gdcms::Writer w;
    gdcms::File &file = w.GetFile();
    //gdcms::DataSet &ds = file.GetDataSet();
    //w.SetCheckFileMetaInformation( true );
    w.SetFileName( outfile );
    file.GetHeader().SetDataSetTransferSyntax( gdcms::TransferSyntax::ImplicitVRLittleEndian );
    gdcms::Anonymizer anon;
    anon.SetFile( file );
    gdcms::MediaStorage ms = gdcms::MediaStorage::RawDataStorage;
    gdcms::UIDGenerator gen;
    anon.Replace( gdcms::Tag(0x0008,0x16), ms.GetString() );
    std::cout << ms.GetString() << std::endl;
    anon.Replace( gdcms::Tag(0x0008,0x18), gen.Generate() );
    if( !w.Write() )
    {
        std::cerr << "Could not write: " << outfile << std::endl;
        return 1;
    }
    return 0;
}

```

## 12.62 ExtractEncryptedContent.cxx

```

/*=====

Program: GDCM (Grassroots DICOM). A DICOM library

Copyright (c) 2006-2011 Mathieu Malaterre
All rights reserved.
See Copyright.txt or http://gdcms.sourceforge.net/Copyright.html for details.

This software is distributed WITHOUT ANY WARRANTY; without even

```



```

    the implied warranty of MERCHANTABILITY or FITNESS FOR A PARTICULAR
    PURPOSE. See the above copyright notice for more information.

=====*/
#include "gdcmReader.h"
#include <fstream>
/*

openssl smime -encrypt -binary -aes256 -in outputfile.dcm -inform DER -out outputfile.der -outform DER
    ../trunk/Testing/Source/Data/certificate.pem

openssl smime -decrypt -binary -in out.der -inform DER -out outputfile.dcm -outform DER -inkey
    ../trunk/Testing/Source/Data/privatekey.pem ../trunk/Testing/Source/Data/certificate.pem

*/
int main(int argc, char *argv[])
{
    if( argc < 3 )
    {
        std::cerr << argv[0] << " input.dcm output.der" << std::endl;
        return 1;
    }
    const char *filename = argv[1];
    const char *outfilename = argv[2];
    gdcm::Reader reader;
    reader.SetFileName( filename );
    if( !reader.Read() )
    {
        return 1;
    }
    gdcm::File &file = reader.GetFile();
    gdcm::DataSet &ds = file.GetDataSet();
    const gdcm::DataElement &EncryptedAttributesSequence = ds.GetDataElement( gdcm::Tag( 0x0400,0x0500 ) );
    gdcm::SequenceOfItems *sqi = EncryptedAttributesSequence.GetValueAsSQ();
    if ( !sqi || sqi->GetNumberOfItems() != 1 ) return 1;
    gdcm::Item &item = sqi->GetItem(1);
    gdcm::DataSet &nestedds = item.GetNestedDataSet();
    if( ! nestedds.FindDataElement( gdcm::Tag( 0x0400,0x0520 ) ) ) return 1;
    const gdcm::DataElement &EncryptedContent = nestedds.GetDataElement( gdcm::Tag( 0x0400,0x0520 ) );
    const gdcm::ByteValue *bv = EncryptedContent.GetByteValue();
    std::ofstream of( outfile, std::ios::binary );
    of.write( bv->GetPointer(), bv->GetLength() );
    of.close();
    return 0;
}

```

## 12.63 ExtractIconFromFile.cpp

```

/*=====
Program: GDCM (Grassroots DICOM). A DICOM library

Copyright (c) 2006-2011 Mathieu Malaterre
All rights reserved.
See Copyright.txt or http://gdcm.sourceforge.net/Copyright.html for details.

This software is distributed WITHOUT ANY WARRANTY; without even
the implied warranty of MERCHANTABILITY or FITNESS FOR A PARTICULAR
PURPOSE. See the above copyright notice for more information.

=====*/
/*
* This example shows how to either retrieve an Icon if present somewhere
* in the file, or else generate one.
*/
#include "gdcmImageReader.h"
#include "gdcmPNMCodec.h"
#include "gdcmIconImageFilter.h"
#include "gdcmIconImageGenerator.h"
bool WriteIconAsPNM(const char* filename, const gdcm::IconImage& icon)
{
    gdcm::PNMCodec pnm;
    pnm.SetDimensions( icon.GetDimensions() );
    pnm.SetPixelFormat( icon.GetPixelFormat() );
    pnm.SetPhotometricInterpretation( icon.GetPhotometricInterpretation() );
    pnm.SetLUT( icon.GetLUT() );
    const gdcm::DataElement& in = icon.GetDataElement();

```

```

bool b = pnm.Write( filename, in );
assert( b );
return b;
}
int main(int argc, char *argv [])
{
    if( argc < 2 ) return 1;
    const char *filename = argv[1];
    gdcm::ImageReader reader;
    reader.SetFileName( filename );
    if( !reader.Read() )
    {
        std::cerr << "Failed to read (or not image): " << filename << std::endl;
        return 1;
    }
    gdcm::IconImageFilter iif;
    iif.SetFile( reader.GetFile() );
    bool b = iif.Extract();
    if( b )
    {
        const gdcm::IconImage &icon = iif.GetIconImage(0);
        icon.Print( std::cout );
        if( !icon.GetTransferSyntax().IsEncapsulated() )
        {
            // Let's write out this icon as PNM file
            WriteIconAsPNM("icon.ppm", icon);
        }
        else if( icon.GetTransferSyntax() == gdcm::TransferSyntax::JPEGBaselineProcess1
        || icon.GetTransferSyntax() == gdcm::TransferSyntax::JPEGExtendedProcess2_4
        )
        {
            const gdcm::DataElement& in = icon.GetDataElement();
            const gdcm::ByteValue *bv = in.GetByteValue();
            assert( bv );
            std::ofstream out( "icon.jpg", std::ios::binary );
            out.write( bv->GetPointer(), bv->GetLength() );
            out.close();
        }
    }
    else
    {
        assert( iif.GetNumberOfIconImages() == 0 );
        std::cerr << "No Icon Found anywhere in file" << std::endl;
        const gdcm::Image &img = reader.GetImage();
        gdcm::IconImageGenerator iig;
        iig.AutoPixelMinMax(true);
        iig.SetPixmap( img );
        const unsigned int idims[2] = { 64, 64 };
        iig.SetOutputDimensions( idims );
        //iig.SetPixelMinMax(60, 868);
        if( !iig.Generate() ) return 1;
        const gdcm::IconImage &icon = iig.GetIconImage();
        WriteIconAsPNM("icon.ppm", icon);
    }
    return 0;
}

```

## 12.64 Extracting\_All\_Resolution.cxx

```

/*=====
Program: GDCM (Grassroots DICOM). A DICOM library

Copyright (c) 2006-2011 Mathieu Malaterre
All rights reserved.
See Copyright.txt or http://gdcm.sourceforge.net/Copyright.html for details.

This software is distributed WITHOUT ANY WARRANTY; without even
the implied warranty of MERCHANTABILITY or FITNESS FOR A PARTICULAR
PURPOSE. See the above copyright notice for more information.

=====*/
// This work was realised during the GSOC 2011 by Manoj Alwani
#include <fstream>
#include <stdint.h>
#include <string.h>
#include <assert.h>

```

```

#include <gdcm_j2k.h>
#include <gdcm_jp2.h>
#include<iostream>
#include <cstring>
#include <stdio.h>
#include <string.h>
#include <stdlib.h>
#include <math.h>
#include "gdcmImageReader.h"
#include "gdcmSequenceOfItems.h"
#include "gdcmSystem.h"
#include <fstream>
#include "gdcm_openjpeg.h"
#include "gdcmMediaStorage.h"
#include "gdcmWriter.h"
#include "gdcmItem.h"
#include "gdcmImageReader.h"
#include "gdcmAttribute.h"
#include "gdcmFile.h"
#include "gdcmTag.h"
#include "gdcmTransferSyntax.h"
#include "gdcmUIDGenerator.h"
#include "gdcmAnonymizer.h"
#include "gdcmStreamImageWriter.h"
#include "gdcmImageHelper.h"
#include "gdcmTrace.h"
void error_callback(const char *msg, void *) {
    (void)msg;
}
void warning_callback(const char *msg, void *) {
    (void)msg;
}
void info_callback(const char *msg, void *) {
    (void)msg;
}
bool Write_Resolution(gdcm::StreamImageWriter & theStreamWriter, const char *filename, int res, std::ostream&
    of, int flag, gdcm::SequenceOfItems *sq, int No_Of_Resolutions)
{
    std::ifstream is;
    is.open( filename, std::ios::binary );
    opj_dparameters_t parameters; /* decompression parameters */
    opj_event_mgr_t event_mgr; /* event manager */
    opj_dinfo_t *dinfo; /* handle to a decompressor */
    opj_cio_t *cio;
    opj_image_t *image = NULL;
    // FIXME: Do some stupid work:
    is.seekg( 0, std::ios::end);
    std::streampos buf_size = is.tellg();
    char *dummy_buffer = new char[(unsigned int)buf_size];
    is.seekg(0, std::ios::beg);
    is.read( dummy_buffer, buf_size);
    unsigned char *src = (unsigned char*)dummy_buffer;
    uint32_t file_length = (uint32_t)buf_size; // 32bits truncation should be ok since DICOM cannot have larger
        than 2Gb image
    /* configure the event callbacks (not required) */
    memset(&event_mgr, 0, sizeof(opj_event_mgr_t));
    event_mgr.error_handler = error_callback;
    event_mgr.warning_handler = warning_callback;
    event_mgr.info_handler = info_callback;
    /* set decoding parameters to default values */
    opj_set_default_decoder_parameters(&parameters);
    // default blindly copied
    parameters.cp_layer=0;
    parameters.cp_reduce= res;
    // parameters.decod_format=-1;
    // parameters.cod_format=-1;
    const char jp2magic[] = "\x00\x00\x00\x0C\x6A\x50\x20\x20\x0D\x0A\x87\x0A";
    if( memcmp( src, jp2magic, sizeof(jp2magic) ) == 0 )
    {
        /* JPEG-2000 compressed image data ... sigh */
        // gdcmData/ELSCINT1_JP2vsJ2K.dcm
        // gdcmData/MAROTTECH_CT_JP2Lossy.dcm
        //gdcmWarningMacro( "J2K start like JPEG-2000 compressed image data instead of codestream" );
        parameters.decod_format = 1; //JP2_CFMT;
        //assert(parameters.decod_format == JP2_CFMT);
    }
    else
    {
        /* JPEG-2000 codestream */
        //parameters.decod_format = J2K_CFMT;
        //assert(parameters.decod_format == J2K_CFMT);
    }
}

```

```

    assert( 0 );
}
parameters.cod_format = 11; // PGX_DFMT;
//assert(parameters.cod_format == PGX_DFMT);
/* get a decoder handle */
dinfo = opj_create_decompress(CODEC_JP2);
/* catch events using our callbacks and give a local context */
opj_set_event_mgr((opj_common_ptr)dinfo, &event_mgr, NULL);
/* setup the decoder decoding parameters using user parameters */
opj_setup_decoder(dinfo, &parameters);
/* open a byte stream */
cio = opj_cio_open((opj_common_ptr)dinfo, src, file_length);
/* decode the stream and fill the image structure */
image = opj_decode(dinfo, cio);
if(!image) {
    opj_destroy_decompress(dinfo);
    opj_cio_close(cio);
    //gdcmlErrorMacro( "opj_decode failed" );
    return 1;
}

opj_cp_t * cp = ((opj_jp2_t*)dinfo->jp2_handle)->j2k->cp;
opj_tcp_t *tcp = &cp->tcps[0];
opj_tccp_t *tccp = &tcp->tccps[0];
/* std::cout << "\n No of Cols In Image" << image->x1;
std::cout << "\n No of Rows In Image" << image->y1;
std::cout << "\n No of Components in Image" << image->numcomps;
std::cout << "\n No of Resolutions" << tccp->numresolutions << "\n";
*/

opj_j2k_t* j2k = NULL;
opj_jp2_t* jp2 = NULL;
jp2 = (opj_jp2_t*)dinfo->jp2_handle;
int reversible = jp2->j2k->cp->tcps->tccps->qmfbid;
//std::cout << reversible;
int compno = 0;
opj_image_comp_t *comp = &image->comps[compno];
int Dimensions[2];
Dimensions[0] = comp->w;
Dimensions[1] = comp->h;
opj_cio_close(cio);
unsigned long len = Dimensions[0]*Dimensions[1] * image->numcomps;
//std::cout << "\nTest" << image->comps[0].factor;
char *raw = new char[len];
for (unsigned int compno = 0; compno < (unsigned int)image->numcomps; compno++)
{
    opj_image_comp_t *comp = &image->comps[compno];
    int w = image->comps[compno].w;
    int h = image->comps[compno].h;
    uint8_t *data8 = (uint8_t*)raw + compno;
    for (int i = 0; i < w * h; i++)
    {
        int v = image->comps[compno].data[i];
        *data8 = (uint8_t)v;
        data8 += image->numcomps;
    }
}

gdcml::Writer w;
gdcml::File &file = w.GetFile();
gdcml::DataSet &ds = file.GetDataSet();
file.GetHeader().SetDataSetTransferSyntax( gdcml::TransferSyntax::ExplicitVRLittleEndian );
gdcml::UIDGenerator uid;
gdcml::DataElement de( gdcml::Tag(0x8,0x18) ); // SOP Instance UID
de.SetVR( gdcml::VR::UI );
const char *u = uid.Generate();
de.SetByteValue( u, strlen(u) );
ds.Insert( de );
gdcml::DataElement del( gdcml::Tag(0x8,0x16) );
del.SetVR( gdcml::VR::UI );
gdcml::MediaStorage ms( gdcml::MediaStorage::CTImageStorage );
del.SetByteValue( ms.GetString(), strlen(ms.GetString()) );
ds.Insert( del );
const char mystr[] = "MONOCHROME2 ";
gdcml::DataElement de2( gdcml::Tag(0x28,0x04) );
//de.SetTag(gdcml::Tag(0x28,0x04));
de2.SetVR( gdcml::VR::CS );
de2.SetByteValue(mystr, strlen(mystr));
ds.Insert( de2 );
gdcml::Attribute<0x0028,0x0010> row = {image->comps[0].w};
//row.SetValue(512);
ds.Insert( row.GetAsDataElement() );
// w.SetCheckFileMetaInformation( true );
gdcml::Attribute<0x0028,0x0011> col = {image->comps[0].h};

```

```

ds.Insert( col.GetAsDataElement() );
gdc::Attribute<0x0028,0x0008> Number_Of_Frames = {1};
ds.Insert( Number_Of_Frames.GetAsDataElement() );
gdc::Attribute<0x0028,0x0100> at = {8};
ds.Insert( at.GetAsDataElement() );
gdc::Attribute<0x0028,0x0002> at1 = {image->numcomps};
ds.Insert( at1.GetAsDataElement() );
gdc::Attribute<0x0028,0x0101> at2 = {8};
ds.Insert( at2.GetAsDataElement() );
gdc::Attribute<0x0028,0x0102> at3 = {7};
ds.Insert( at3.GetAsDataElement() );
if (flag == 1)
{
    for (int i=0; i < No_Of_Resolutions; i++)
    {
        int a = 1;
        int b =1;
        while(a!==(No_Of_Resolutions)-i)
        {
            b = b*2;
            a = a+1;
        }
        uint16_t row = (image->y1)/b;
        uint16_t col = (image->x1)/b;
        //std::cout << row;
        gdc::Element<gdc::VR::IS,gdc::VM::VM1> el2;
        el2.SetValue(i+1);
        gdc::DataElement rfn = el2.GetAsDataElement(); //ulr --> upper left row
        rfn.SetTag( gdc::Tag(0x0008,0x1160) );
        gdc::Element<gdc::VR::US,gdc::VM::VM2> el;
        el.SetValue(1,0);
        el.SetValue(1,1);
        gdc::DataElement ulr = el.GetAsDataElement(); //ulr --> upper left col/row
        ulr.SetTag( gdc::Tag(0x0048,0x0201) );
        gdc::Element<gdc::VR::US,gdc::VM::VM2> el1;
        el1.SetValue(col,0);
        el1.SetValue(row,1);
        gdc::DataElement brr = el1.GetAsDataElement();
        brr.SetTag( gdc::Tag(0x0048,0x0202) ); //brr --> bottom right col/row
        gdc::Item it;
        gdc::DataSet &nds = it.GetNestedDataSet();
        nds.Insert( rfn );
        nds.Insert( ulr );
        nds.Insert( brr );
        sq->AddItem(it);
    }
    gdc::Writer w1;
    gdc::File &file1 = w1.GetFile();
    gdc::DataSet &ds1 = file1.GetDataSet();
    file1.GetHeader().SetDataSetTransferSyntax( gdc::TransferSyntax::ExplicitVRLittleEndian );
    gdc::UIDGenerator uid1;
    gdc::DataElement dea( gdc::Tag(0x8,0x18) ); // SOP Instance UID
    dea.SetVR( gdc::VR::UI );
    const char *ul = uid1.Generate();
    dea.SetByteValue( ul, strlen(ul) );
    ds1.Insert( dea );
    gdc::DataElement deb( gdc::Tag(0x8,0x16) );
    deb.SetVR( gdc::VR::UI );
    gdc::MediaStorage msl( gdc::MediaStorage::VLWholeSlideMicroscopyImageStorage );
    deb.SetByteValue( msl.GetString(), strlen( msl.GetString() );
    ds1.Insert( deb );
    const char mystrl[] = "MONOCHROME2 ";
    gdc::DataElement dec( gdc::Tag(0x28,0x04) );
    //de.SetTag(gdc::Tag(0x28,0x04));
    dec.SetVR( gdc::VR::CS );
    dec.SetByteValue(mystrl, strlen(mystrl));
    ds1.Insert( dec );
    gdc::Attribute<0x0028,0x0010> row1 = {image->y1};
    //row.SetValue(512);
    ds1.Insert( row1.GetAsDataElement() );
    // w.SetCheckFileMetaInformation( true );
    gdc::Attribute<0x0028,0x0011> col1 = {image->x1};
    ds1.Insert( col1.GetAsDataElement() );
    gdc::Attribute<0x0028,0x0008> Number_Of_Frames1 = {tccp->numresolutions};
    ds1.Insert( Number_Of_Frames1.GetAsDataElement() );
    gdc::Attribute<0x0028,0x0100> ata = {8};
    ds1.Insert( ata.GetAsDataElement() );
    gdc::Attribute<0x0028,0x0002> atb = {image->numcomps};
    ds1.Insert( atb.GetAsDataElement() );
    gdc::Attribute<0x0028,0x0101> atc = {8};
    ds1.Insert( atc.GetAsDataElement() );
}

```

```

gdcM::Attribute<0x0028,0x0102> atd = {7};
dsl.Insert( atd.GetAsDataElement() );
theStreamWriter.SetFile(file1);
gdcM::DataElement des( gdcM::Tag(0x0048,0x0200) );
des.SetVR(gdcM::VR::SQ);
//des.SetVR(gdcM::VM::VM1);
des.SetValue(*sq);
des.SetVLTToUndefined();
dsl.Insert(des);
if (!theStreamWriter.WriteImageInformation()){
    std::cerr << "unable to write image information" << std::endl;
    return 1; //the CanWrite function should prevent getting here, else,
    //that's a test failure
}
}
theStreamWriter.SetFile(file);
if (!theStreamWriter.CanWriteFile()){
    delete [] raw;
    std::cout << "Not able to write";
    return 0; //this means that the file was unwritable, period.
    //very similar to a ReadImageInformation failure
}
else
    std::cout<<"\nbletoread";
// Important to write here
std::vector<unsigned int> extent = gdcM::ImageHelper::GetDimensionsValue(file);
unsigned short xmax = extent[0];
unsigned short ymax = extent[1];
unsigned short theChunkSize = 4;
unsigned short ychunk = extent[1]/theChunkSize; //go in chunk sizes of theChunkSize
unsigned short zmax = extent[2];
std::cout << "\n" << xmax << "\n" << ymax << "\n" << zmax << "\n" << image->numcomps << "\n";
if (xmax == 0 || ymax == 0)
{
    std::cerr << "Image has no size, unable to write zero-sized image." << std::endl;
    return 0;
}
int z, y, nexty;
unsigned long prevLen = 0; //when going through the char buffer, make sure to grab
//the bytes sequentially. So, store how far you got in the buffer with each iteration.
for (z = 0; z < zmax; ++z){
    for (y = 0; y < ymax; y += ychunk){
        nexty = y + ychunk;
        if (nexty > ymax) nexty = ymax;
        theStreamWriter.DefinePixelExtent(0, xmax, y, nexty, z, z+1);
        unsigned long len = theStreamWriter.DefineProperBufferLength();
        std::cout << "\n" << len;
        char* finalBuffer = new char[len];
        memcpy(finalBuffer, &(raw[prevLen]), len);
        std::cout << "\nable to write";
        if (!theStreamWriter.Write(finalBuffer, len)){
            std::cerr << "writing failure:" << "output.dcm" << " at y = " << y << " and z = " << z << std::endl;
            delete [] raw;
            delete [] finalBuffer;
            return 1;
        }
        delete [] finalBuffer;
        prevLen += len;
    }
}
delete raw;
delete[] src; //FIXME
if(dinfo) {
    opj_destroy_decompress(dinfo);
}
opj_image_destroy(image);
return true;
}
bool Different_Resolution( gdcM::StreamWriter & theStreamWriter, const char *filename, int res,
    std::ostream& of)
{
    //std::vector<std::string>::const_iterator it = filenames.begin();
    bool b = true;
    int flag = 1;
    gdcM::SmartPointer<gdcM::SequenceOfItems> sq = new gdcM::SequenceOfItems();
    sq->SetLengthToUndefined();
    for(int i = res-1 ; i>=0; --i)
    {
        b = b && Write_Resolution( theStreamWriter, filename, i, of ,flag,sq,res);
        // b = b && Get_Resolution( theStreamWriter, filename, i, of ,0);
        flag = 0;
    }
}

```

```

    }
    //b = b && Get_Lowest_Resolution( writer, sq, filename, res-1 );
    //b = b && PopulateSingeFile( writer, sq, jpeg, filename2 );
    //image.SetDimension(2, res )
    return b;
}
int main(int argc, char *argv[])
{
    if( argc < 4 )
    {
        std::cerr << argv[0] << " input.jp2 output.dcm No. Of Resolutions " << std::endl;
        return 1;
    }
    const char *filename = argv[1];
    const char *outfilename = argv[2];
    char *resolutions = argv[3];
    int res = int((*resolutions)-48);
    //std:: cout << "\nres" << res;
    gdcm::StreamImageWriter theStreamWriter;
    std::ofstream of;
    of.open( outfile, std::ios::out | std::ios::binary );
    theStreamWriter.SetStream(of);
    if( !Different_Resolution( theStreamWriter, filename,res,of ) ) return 1;
    uint16_t firstTag1 = 0xffff;
    uint16_t secondTag1 = 0xe0dd;
    uint32_t thirdTag1 = 0x00000000;
    //uint16_t fourthTag1 = 0xffff;
    const int theBufferSize = 2*sizeof(uint16_t)+sizeof(uint32_t);
    char* tmpBuffer2 = new char[theBufferSize];
    memcpy(&(tmpBuffer2[0]), &firstTag1, sizeof(uint16_t));
    memcpy(&(tmpBuffer2[sizeof(uint16_t)]), &secondTag1, sizeof(uint16_t));
    memcpy(&(tmpBuffer2[2*sizeof(uint16_t)]), &thirdTag1, sizeof(uint32_t));
    //memcpy(&(tmpBuffer2[3*sizeof(uint16_t)]), &fourthTag1, sizeof(uint16_t));
    assert( of && !of.eof() && of.good() );
    of.write(tmpBuffer2, theBufferSize);
    of.flush();
    assert( of );
    return 0;
}

```

## 12.65 Fake\_Image\_Using\_Stream\_Image\_Writer.cxx

```

/*=====
Program: GDCM (Grassroots DICOM). A DICOM library

Copyright (c) 2006-2011 Mathieu Malaterre
All rights reserved.
See Copyright.txt or http://gdcm.sourceforge.net/Copyright.html for details.

This software is distributed WITHOUT ANY WARRANTY; without even
the implied warranty of MERCHANTABILITY or FITNESS FOR A PARTICULAR
PURPOSE. See the above copyright notice for more information.

=====*/
// This work was realised during the GSOC 2011 by Manoj Alwani
#include "gdcmReader.h"
#include "gdcmMediaStorage.h"
#include "gdcmWriter.h"
#include "gdcmItem.h"
#include "gdcmImageReader.h"
#include "gdcmAttribute.h"
#include "gdcmFile.h"
#include "gdcmTag.h"
#include "gdcmTransferSyntax.h"
#include "gdcmUIDGenerator.h"
#include "gdcmAnonymizer.h"
#include "gdcmStreamImageWriter.h"
#include "gdcmImageHelper.h"
#include "gdcmTrace.h"
int main(int, char *[])
{
    char * buffer = new char[ 256 * 256 *3 ];
    // *p = (uint8_t*)buffer;
    char * p = buffer;
    gdcm::Trace::DebugOn();
    gdcm::Trace::WarningOn();
}

```

```

for(int row = 0; row < 256; ++row)
{
    for(int col = 0; col < 256; ++col)
        //for(int b = 0; b < 256; ++b)
        {
            *p++ = 255;
            *p++ = 0;
            *p++ = 0;
        }
}
gdcmm::Writer w;
gdcmm::File &file = w.GetFile();
gdcmm::DataSet &ds = file.GetDataSet();
file.GetHeader().SetDataSetTransferSyntax( gdcmm::TransferSyntax::ExplicitVRLittleEndian );
gdcmm::UIDGenerator uid;
gdcmm::DataElement de( gdcmm::Tag(0x8,0x18) ); // SOP Instance UID
de.SetVR( gdcmm::VR::UI );
const char *u = uid.Generate();
de.SetByteValue( u, strlen(u) );
ds.Insert( de );
gdcmm::DataElement del( gdcmm::Tag(0x8,0x16) );
del.SetVR( gdcmm::VR::UI );
gdcmm::MediaStorage ms( gdcmm::MediaStorage::VLWholeSlideMicroscopyImageStorage );
del.SetByteValue( ms.GetString(), strlen(ms.GetString()) );
ds.Insert( del );
const char mystr[] = "RGB";
gdcmm::DataElement de2( gdcmm::Tag(0x28,0x04) );
//de.SetTag( gdcmm::Tag(0x28,0x04) );
de2.SetVR( gdcmm::VR::CS );
de2.SetByteValue(mystr, strlen(mystr));
ds.Insert( de2 );
gdcmm::Attribute<0x0028,0x0010> row = {256};
//row.SetValue(512);
ds.Insert( row.GetAsDataElement() );
// w.SetCheckFileMetaInformation( true );
gdcmm::Attribute<0x0028,0x0011> col = {256};
ds.Insert( col.GetAsDataElement() );
gdcmm::Attribute<0x0028,0x0008> Number_Of_Frames = {1};
ds.Insert( Number_Of_Frames.GetAsDataElement() );
gdcmm::Attribute<0x0028,0x0100> at = {8};
ds.Insert( at.GetAsDataElement() );
gdcmm::Attribute<0x0028,0x0002> at1 = {3}; //bits per pixel
ds.Insert( at1.GetAsDataElement() );
gdcmm::Attribute<0x0028,0x0101> at2 = {8};
ds.Insert( at2.GetAsDataElement() );
gdcmm::Attribute<0x0028,0x0102> at3 = {7};
ds.Insert( at3.GetAsDataElement() );
gdcmm::Attribute<0x0028,0x0006> at4 = {0};
ds.Insert( at4.GetAsDataElement() );
gdcmm::Attribute<0x0028,0x0103> at5 = {0};
ds.Insert( at5.GetAsDataElement() );
//de.SetTag( gdcmm::Tag(0x7fe0,0x0010) );
//ds.Insert( de );
gdcmm::StreamImageWriter theStreamWriter;
gdcmm::SmartPointer<gdcmm::SequenceOfItems> sq = new gdcmm::SequenceOfItems();
sq->SetLengthToUndefined();
uint16_t row1 = 256;
uint16_t col1 = 256;
//std::cout << row;
gdcmm::Element<gdcmm::VR::IS, gdcmm::VM::VM1> el2;
el2.SetValue(1);
gdcmm::DataElement rfn = el2.GetAsDataElement(); //rfn ---> reference frame number
rfn.SetTag( gdcmm::Tag(0x0008,0x1160) );
gdcmm::Element<gdcmm::VR::US, gdcmm::VM::VM2> el;
el.SetValue(1,0);
el.SetValue(1,1);
gdcmm::DataElement ulr = el.GetAsDataElement(); //ulr --> upper left col/row
ulr.SetTag( gdcmm::Tag(0x0048,0x0201) );
gdcmm::Element<gdcmm::VR::US, gdcmm::VM::VM2> e11;
e11.SetValue(col1,0);
e11.SetValue(row1,1);
gdcmm::DataElement brr = e11.GetAsDataElement();
brr.SetTag( gdcmm::Tag(0x0048,0x0202) ); //brr --> bottom right col/row
gdcmm::Item it;
gdcmm::DataSet &nds = it.GetNestedDataSet();
nds.Insert( rfn );
nds.Insert( ulr );
nds.Insert( brr );
sq->AddItem(it);
gdcmm::DataElement des( gdcmm::Tag(0x0048,0x0200) );
des.SetVR( gdcmm::VR::SQ );

```



```

    des.SetValue(*sq);
    des.SetVLTToUndefined();
    ds.Insert(des);
    theStreamWriter.SetFile(file);
    std::ofstream of;
    of.open("output.dcm", std::ios::out | std::ios::binary);
    theStreamWriter.SetStream(of);
    if (!theStreamWriter.CanWriteFile()){
        delete [] buffer;
        std::cout << "Not able to write";
        return 0; //this means that the file was unwritable, period.
        //very similar to a ReadImageInformation failure
    }
    else
        std::cout<<"\nable to read";
    if (!theStreamWriter.WriteImageInformation()){
        std::cerr << "unable to write image information" << std::endl;
        delete [] buffer;
        return 1; //the CanWrite function should prevent getting here, else,
        //that's a test failure
    }
    std::vector<unsigned int> extent =
        gdc::ImageHelper::GetDimensionsValue(file);
    unsigned short xmax = extent[0];
    unsigned short ymax = extent[1];
    unsigned short theChunkSize = 1;
    unsigned short ychunk = extent[1]/theChunkSize; //go in chunk sizes of theChunkSize
    unsigned short zmax = extent[2];
    std::cout << xmax << ymax << zmax;
    if (xmax == 0 || ymax == 0)
    {
        std::cerr << "Image has no size, unable to write zero-sized image." << std::endl;
        return 0;
    }
    int z, y, nexty;
    unsigned long prevLen = 0; //when going through the char buffer, make sure to grab
    //the bytes sequentially. So, store how far you got in the buffer with each iteration.
    for (z = 0; z < zmax; ++z){
        for (y = 0; y < ymax; y += ychunk){
            nexty = y + ychunk;
            if (nexty > ymax) nexty = ymax;
            theStreamWriter.DefinePixelExtent(0, xmax, y, nexty, z, z+1);
            unsigned long len = theStreamWriter.DefineProperBufferLength();
            std::cout << "\n" << len;
            char* finalBuffer = new char[len];
            memcpy(finalBuffer, &(buffer[prevLen]), len);
            std::cout << "\nable to write";
            if (!theStreamWriter.Write(finalBuffer, len)){
                std::cerr << "writing failure:" << "output.dcm" << " at y = " << y << " and z = " << z << std::endl;
                delete [] buffer;
                delete [] finalBuffer;
                return 1;
            }
            delete [] finalBuffer;
            prevLen += len;
        }
    }
    delete buffer;
    uint16_t firstTag1 = 0xfffe;
    uint16_t secondTag1 = 0xe0dd;
    uint32_t thirdTag1 = 0x00000000;
    //uint16_t fourthTag1 = 0xffff;
    const int theBufferSize1 = 2*sizeof(uint16_t)+sizeof(uint32_t);
    char* tmpBuffer2 = new char[theBufferSize1];
    memcpy(&(tmpBuffer2[0]), &firstTag1, sizeof(uint16_t));
    memcpy(&(tmpBuffer2[sizeof(uint16_t)]), &secondTag1, sizeof(uint16_t));
    memcpy(&(tmpBuffer2[2*sizeof(uint16_t)]), &thirdTag1, sizeof(uint32_t));
    //memcpy(&(tmpBuffer2[3*sizeof(uint16_t)]), &fourthTag1, sizeof(uint16_t));
    assert( of && !of.eof() && of.good() );
    of.write(tmpBuffer2, theBufferSize1);
    of.flush();
    assert( of );
    return 0;
}

```

## 12.66 FixBrokenJ2K.cxx

/\*=====

Program: GDCM (Grassroots DICOM). A DICOM library

Copyright (c) 2006-2011 Mathieu Malaterre

All rights reserved.

See Copyright.txt or <http://gdcms.sourceforge.net/Copyright.html> for details.

This software is distributed WITHOUT ANY WARRANTY; without even the implied warranty of MERCHANTABILITY or FITNESS FOR A PARTICULAR PURPOSE. See the above copyright notice for more information.

```

=====*/
#include "gdcmReader.h"
#include "gdcmWriter.h"
#include "gdcmImageReader.h"
#include "gdcmSequenceOfFragments.h"
#include "gdcmFile.h"
// http://www.lost.in.ua/dicom/c.dcm
//
// -> BuggyJ2Kvuvua-fixed2-j2k.dcm
/*
 * This program attempts to fix a broken J2K/DICOM:
 * It contains 2 bugs:
 * 1. The first 8 bytes seems to be random bytes: remove them
 * 2. YCC is set to 1, while image is grayscale need to set it back to 0
 *
 * Ref:
 * It's a software from http://rentgenprom.ru/ , shipped with universal digital radiographic units
 * "ProScan-2000". The Ukrainian manufacturer developed own digital radiographic unit and it is
 * compatible with software from "ProScan-2000".
 * Information found in DICOM file is:
 *
 * (0008,0070) LO [ZAO "Renthenprom" (JSC Rentgenprom) ]           # 36,1 Manufacturer
 * (0018,1020) LO [2.13.1.7]                                       # 8,1-n Software Version(s)
 */
int main(int argc, char *argv[])
{
    if( argc < 3 )
    {
        std::cerr << argv[0] << " input.dcm output.dcm" << std::endl;
        return 1;
    }
    const char *filename = argv[1];
    const char *outfilename = argv[2];
    gdcm::Reader reader;
    reader.SetFileName( filename );
    if( !reader.Read() )
    {
        return 1;
    }
    gdcm::File &file = reader.GetFile();
    const gdcm::DataElement &pixeldata0 = file.GetDataSet().GetDataElement( gdcm::Tag(0x7fe0,0x0010) );
    const gdcm::SequenceOfFragments *sqf = pixeldata0.GetSequenceOfFragments();
    if( !sqf )
    {
        return 1;
    }
    const gdcm::Fragment &frag0 = sqf->GetFragment(0);
    gdcm::ByteValue *bv = const_cast<gdcm::ByteValue*>(frag0.GetByteValue());
    char *ptr = (char*)bv->GetVoidPointer();
    size_t len = bv->GetLength();
    static const unsigned char sig[] = {0,0,0,0,0x6A,0x70,0x32,0x63};
    if( memcmp(ptr, sig, sizeof(sig)) != 0 )
    {
        std::cerr << "magic random signature not found" << std::endl;
        return 1;
    }
    // Apparently the flag to enable a color transform on 3 color components is set in
    // the COD marker. (YCC is byte[6] in the COD marker)
    // we need to disable this flag;
    char *cod_marker = ptr + 0x35; /* 0x2d + 0x8 */ // FIXME
    if( cod_marker[0] == (char)0xff && cod_marker[1] == 0x52 )
    {
        // found start of COD
        if( cod_marker[6+2] == 1 )
        {
            // Change in place:
            *((char*)cod_marker + 6+2) = 0;
            // Prepare a new DataElement:
            gdcm::DataElement pixeldata( gdcm::Tag(0x7fe0,0x0010) );

```

```

    pixeldata.SetVR( gdcmm::VR::OB );
    gdcmm::SmartPointer<gdcmm::SequenceOfFragments> sq = new gdcmm::SequenceOfFragments;
    gdcmm::Fragment frag;
    // remove 8 first bytes:
    frag.SetByteValue( ptr + 8, (uint32_t)(len - 8) );
    sq->AddFragment( frag );
    pixeldata.SetValue( *sq );
    file.GetDataSet().Replace( pixeldata );
}
else
{
    return 1;
}
}
else
{
    std::cerr << "COD not found" << (int)cod_marker[0] << std::endl;
    return 1;
}
gdcmm::Writer writer;
writer.SetFile( reader.GetFile() );
writer.SetFileName( outfilename );
writer.CheckFileMetaInformationOff();
if( !writer.Write() )
{
    std::cerr << "Could not write" << std::endl;
}
// paranoid check:
gdcmm::ImageReader ireader;
ireader.SetFileName( outfilename );
if( !ireader.Read() )
{
    std::cerr << "file written is still not valid, please report" << std::endl;
    return 1;
}
return 0;
}
}

```

## 12.67 FixJAIBugJPEGLS.cxx

```

/*=====
Program: GDCM (Grassroots DICOM). A DICOM library

Copyright (c) 2006-2011 Mathieu Malaterre
All rights reserved.
See Copyright.txt or http://gdcmm.sourceforge.net/Copyright.html for details.

This software is distributed WITHOUT ANY WARRANTY; without even
the implied warranty of MERCHANTABILITY or FITNESS FOR A PARTICULAR
PURPOSE. See the above copyright notice for more information.

=====*/
#include "gdcmmReader.h"
#include "gdcmmWriter.h"
#include "gdcmmImageReader.h"
#include <fstream>
#include "gdcmm_charls.h"
/*
 * This small example should show how one can handle the famous JAI-JPEGLS bug
 * It will take in as invalid DICOM/JAI-JPEG-LS and write out as Explicit Little
 * Endian. One can use 'gdcmmconv --jpegls' to recompress properly
 *
 * References:
 * http://charls.codeplex.com/discussions/230307?ProjectName=charls
 * http://charls.codeplex.com/workitem/7297
 * http://www.dcm4che.org/jira/browse/DCM-442
 * http://www.dcm4che.org/jira/browse/DCMEE-1144
 * http://java.net/jira/browse/JAI_IMAGEIO_CORE-183
 *
 * Explanation of the issue:
 *
 * Seems, the error is in the calculation of the default values for thresholds T1,
 * T2, T3, in particular min(MAXVAL, 4095) is not applied in
 *
 * FACTOR = (min(MAXVAL, 4095) + 128)/256
 *
 */

```

```

* as specified in http://www.itu.int/rec/T-REC-T.87-199806-I/en .
*
*/
int main(int argc, char *argv[])
{
    if( argc < 3 )
    {
        std::cerr << argv[0] << " input.dcm output.dcm" << std::endl;
        return 1;
    }
    const char *filename = argv[1];
    const char *outfilename = argv[2];
    gdcm::FileMetaInformation::SetSourceApplicationEntityTitle( "FixJAIBugJPEGLS" );
    gdcm::ImageReader reader;
    reader.SetFileName( filename );
    if( !reader.Read() )
    {
        return 1;
    }
    gdcm::Image &image = reader.GetImage();
    //unsigned long len = image.GetBufferLength();
    const gdcm::DataElement &in =
        reader.GetFile().GetDataSet().GetDataElement( gdcm::Tag(0x7fe0,0x0010) );
    const gdcm::SequenceOfFragments *sf = in.GetSequenceOfFragments();
    if( !sf )
    {
        std::cerr << "No pixel data (or not encapsulated)" << std::endl;
        return 1;
    }
    const unsigned int *dims = image.GetDimensions();
    if ( sf->GetNumberOfFragments() != dims[2] )
    {
        std::cerr << "Unsupported" << std::endl;
        return 1;
    }
    // unsigned long totalLen = sf->ComputeByteLength();
    std::vector<unsigned char> rgbyteOutall;
    for(unsigned int i = 0; i < sf->GetNumberOfFragments(); ++i)
    {
        const gdcm::Fragment &frag = sf->GetFragment(i);
        if( frag.IsEmpty() ) return 1;
        const gdcm::ByteValue *bv = frag.GetByteValue();
        if( !bv ) return 1;
        unsigned long totalLen = bv->GetLength();
        std::vector<char> vbuffer;
        vbuffer.resize( totalLen );
        char *buffer = &vbuffer[0];
        bv->GetBuffer(buffer, totalLen);
        const unsigned char* pbyteCompressed0 = (const unsigned char*)buffer;
        while( totalLen > 0 && pbyteCompressed0[totalLen-1] != 0xd9 )
        {
            totalLen--;
        }
        JlsParameters metadata;
        char errorMsg[256+1]={'\0'};
        if (JpegLsReadHeader( buffer, totalLen, &metadata, errorMsg) != charls::ApiResult::OK)
        {
            std::cerr << "Cant parse jpegl: " << errorMsg << std::endl;
            return 1;
        }
    }
    std::cout << metadata.width << std::endl;
    std::cout << metadata.height << std::endl;
    std::cout << metadata.bitsPerSample << std::endl;
    gdcm::PixelFormat const &pf = image.GetPixelFormat();
    std::cout << pf << std::endl;
    // http://charls.codeplex.com/discussions/230307?ProjectName=charls
    unsigned char marker_lse_13[] = {
        0xFF, 0xF8, 0x00, 0x0D,
        0x01,
        0x1F, 0xFF,
        0x00, 0x22, // T1 = 34
        0x00, 0x83, // T2 = 131
        0x02, 0x24, // T3 = 548
        0x00, 0x40
    };
    unsigned char marker_lse_14[] = {
        0xFF, 0xF8, 0x00, 0x0D,
        0x01,
        0x3F, 0xFF,
        0x00, 0x42, // T1 = 66
        0x01, 0x03, // T2 = 259
    };

```

```

    0x04, 0x44, // T3 = 1092
    0x00, 0x40
};
unsigned char marker_lse_15[] = {
    0xFF, 0xF8, 0x00, 0x0D,
    0x01,
    0x7F, 0xFF,
    0x00, 0x82, // T1 = 130
    0x02, 0x03, // T2 = 515
    0x08, 0x84, // T3 = 2180
    0x00, 0x40
};
unsigned char marker_lse_16[] = {
    0xFF, 0xF8, 0x00, 0x0D,
    0x01,
    0xFF, 0xFF,
    0x01, 0x02, // T1 = 258
    0x04, 0x03, // T2 = 1027
    0x11, 0x04, // T3 = 4356
    0x00, 0x40
};
const unsigned char *marker_lse = nullptr;
switch( metadata.bitsPerSample )
{
case 13:
    marker_lse = marker_lse_13;
    break;
case 14:
    marker_lse = marker_lse_14;
    break;
case 15:
    marker_lse = marker_lse_15;
    break;
case 16:
    marker_lse = marker_lse_16;
    break;
}
if( !marker_lse )
{
    std::cerr << "Cant handle: " << metadata.bitsPerSample << std::endl;
    return 1;
}
// FIXME: One should recompute the value for 0x0F
vbuffer.insert( vbuffer.begin() + 0x0F, marker_lse, marker_lse+15);
#endif
std::ofstream of( "/tmp/d.jls", std::ios::binary );
of.write( &vbuffer[0], vbuffer.size() );
of.close();
#endif
const char *pbyteCompressed = &vbuffer[0];
size_t cbyteCompressed = vbuffer.size(); // updated legnth
JlsParameters params;
JpegLsReadHeader(pbyteCompressed, cbyteCompressed, &params, nullptr);
std::vector<unsigned char> rgbyteOut;
//rgbyteOut.resize( image.GetBufferLength() );
rgbyteOut.resize(params.height * params.width * ((params.bitsPerSample + 7)
    / 8) * params.components);
CharlsApiResultType result =
    JpegLsDecode(&rgbyteOut[0], rgbyteOut.size(), pbyteCompressed, cbyteCompressed, &params, errorMsg );
if (result != charls::ApiResult::OK)
{
    std::cerr << "Could not patch JAI-JPEGLS: " << errorMsg << std::endl;
    return 1;
}
rgbyteOutall.insert( rgbyteOutall.end(), rgbyteOut.begin(), rgbyteOut.end() );
}
gdcm::DataElement pixeldata( gdcm::Tag(0x7fe0,0x0010) );
pixeldata.SetVR( gdcm::VR::OW );
pixeldata.SetByteValue( (char*)&rgbyteOutall[0], (uint32_t)rgbyteOutall.size() );
// Add the pixel data element
reader.GetFile().GetDataSet().Replace( pixeldata );
reader.GetFile().GetHeader().SetDataSetTransferSyntax(
    gdcm::TransferSyntax::ExplicitVRLittleEndian);
gdcm::Writer writer;
writer.SetFileName( outfile );
writer.SetFile( reader.GetFile() );
writer.Write();
std::cout << "Success !" << std::endl;
return 0;
}

```

## 12.68 FixOrientation.cxx

```

/*=====
Program: GDCM (Grassroots DICOM). A DICOM library

Copyright (c) 2006-2011 Mathieu Malaterre
All rights reserved.
See Copyright.txt or http://gdcm.sourceforge.net/Copyright.html for details.

This software is distributed WITHOUT ANY WARRANTY; without even
the implied warranty of MERCHANTABILITY or FITNESS FOR A PARTICULAR
PURPOSE. See the above copyright notice for more information.
=====*/
#include "gdcmReader.h"
#include "gdcmWriter.h"
#include "gdcmFile.h"
#include "gdcmOrientation.h"
#include "gdcmAttribute.h"
// Very simple orientation changer, fix invalid dataset
int main(int argc, char* argv[] )
{
    // assume AXIAL input for now
    if( argc < 3 )
    {
        std::cerr << argv[0] << " input.dcm output.dcm" << std::endl;
        return 1;
    }
    const char *filename = argv[1];
    const char *outfilename = argv[2];
    gdcm::Reader reader;
    reader.SetFileName( filename );
    if (! reader.Read() )
    {
        return 1;
    }
    const double axial[] = { 1,0,0, 0,1,0 };
    (void)axial;
    const double coronal[] = { 0,0,1, 1,0,0 };
    (void)coronal;
    const double sagittal[] = { 0,1,0, 0,0,1 };
    (void)sagittal;
    gdcm::Attribute<0x0020,0x0032> at1; // IPP
    (void)at1;
    gdcm::Attribute<0x0020,0x0037> at2; // IOP
    (void)at2;
    gdcm::File & f = reader.GetFile();
    gdcm::DataSet & ds = f.GetDataSet();
    at1.SetFromDataSet( ds );
#ifdef 0
    at2.SetFromDataSet( ds );
    const double * iop = at2.GetValues();
    if( !std::equal(iop, iop + 6, axial) )
    {
        gdcm::Orientation::OrientationType type = gdcm::Orientation::GetType ( iop );
        std::cerr << "Wrong orientation: " << gdcm::Orientation::GetLabel( type ) << std::endl;
        return 1;
    }
    at2.SetValues( sagittal );
    ds.Replace( at2.GetAsDataElement() );
#endif
    // for sagittal: swap element 0 & 2
    const double tmp0 = at1.GetValue(0);
    const double tmp2 = at1.GetValue(2);
    (void)tmp2;
    //at1.SetValue(tmp2, 0);
    //at1.SetValue(tmp0, 2);
    at1.SetValue( - tmp0 );
    ds.Replace( at1.GetAsDataElement() );
    gdcm::Writer writer;
    writer.SetFile( f );
    writer.SetFileName( outfile );
    if ( !writer.Write() )
    {
        return 1;
    }
    return 0;
}

```

## 12.69 GenAIIVR.cxx

```

/*=====
Program: GDCM (Grassroots DICOM). A DICOM library

Copyright (c) 2006-2011 Mathieu Malaterre
All rights reserved.
See Copyright.txt or http://gdcm.sourceforge.net/Copyright.html for details.

This software is distributed WITHOUT ANY WARRANTY; without even
the implied warranty of MERCHANTABILITY or FITNESS FOR A PARTICULAR
PURPOSE. See the above copyright notice for more information.

=====*/
#include "gdcmReader.h"
#include "gdcmGlobal.h"
#include "gdcmDummyValueGenerator.h"
#include "gdcmMediaStorage.h"
#include "gdcmWriter.h"
#include "gdcmItem.h"
#include "gdcmImageReader.h"
#include "gdcmSequenceOfItems.h"
#include "gdcmFile.h"
#include "gdcmTag.h"
#include "gdcmDict.h"
#include "gdcmDictEntry.h"
#include "gdcmDicts.h"
#include "gdcmTransferSyntax.h"
#include "gdcmUIDGenerator.h"
#include "gdcmFileExplicitFilter.h"
#include <cstdlib>
#include <cstring>
gdcm::Tag FindTagFromVR(gdcm::Dict const &dict, gdcm::VR const &vr)
{
    using gdcm::Dict;
    Dict::ConstIterator beg = dict.Begin();
    Dict::ConstIterator end = dict.End();
    Dict::ConstIterator it;
    for( it = beg; it != end; ++it)
    {
        const gdcm::Tag &t = it->first;
        const gdcm::DictEntry &de = it->second;
        const gdcm::VR &vr_de = de.GetVR();
        if( vr == vr_de && !de.GetRetired() && t.GetGroup() >= 0x8 )
        {
            return t;
        }
    }
    return gdcm::Tag(0xffff,0xffff);
}
struct rnd_gen {
    rnd_gen(char const* r = "abcdefghijklmnopqrstuvwxy0123456789")
        : range(r), len(std::strlen(r)) { }
    char operator ()() const {
        return range[static_cast<std::size_t>(std::rand() * (1.0 / ((double)RAND_MAX + 1.0)) * (double)len)];
    }
private:
    char const* range;
    std::size_t len;
};
/*
*/
int main(int argc, char *argv[])
{
    if( argc < 2 )
    {
        std::cerr << argv[0] << " output.dcm" << std::endl;
        return 1;
    }
    const char *outfilename = argv[1];
    static const gdcm::Global &g = gdcm::Global::GetInstance();
    static const gdcm::Dicts &dictionaries = g.GetDicts();
    static const gdcm::Dict &pubdict = dictionaries.GetPublicDict();
    using gdcm::VR;
    using gdcm::Tag;
    gdcm::Writer w;
    gdcm::File &f = w.GetFile();
    gdcm::DataSet &ds = f.GetDataSet();
    gdcm::FileExplicitFilter fef;

```

```

//fef.SetChangePrivateTags( true );
fef.SetFile( w.GetFile() );
if( !fef.Change() )
{
    std::cerr << "Failed to change" << std::endl;
    return 1;
}
gdcmm::SmartPointer<gdcmm::SequenceOfItems> sq = new gdcmm::SequenceOfItems();
sq->SetLengthToUndefined();
// gdcmm::DummyValueGenerator divg;
const std::size_t len = 10;
char ss[len+1];
ss[len] = '\0';
const char owner_str[] = "GDCM CONFORMANCE TESTS";
gdcmm::DataElement owner( gdcmm::Tag(0x4d4d, 0x10) );
owner.SetByteValue( owner_str, (uint32_t)strlen( owner_str ) );
owner.SetVR( gdcmm::VR::LO );
// Create an item
gdcmm::Item it;
it.SetVLToUndefined();
gdcmm::DataSet &nds = it.GetNestedDataSet();
//    nds.Insert( owner );
//    nds.Insert( de );
// Insert sequence into data set
gdcmm::DataElement des( gdcmm::Tag(0x4d4d, 0x1001) );
des.SetVR( gdcmm::VR::SQ );
des.SetValue( *sq );
des.SetVLToUndefined();
ds.Insert( owner );
ds.Insert( des );
// avoid INVALID = 0
for( int i = 1; i < 27; ++i )
{
    VR vr = (VR::VRType)( 1LL << i );
    Tag t = FindTagFromVR( pubdict, vr );
    if( vr != VR::UN && vr != VR::SQ )
    {
        assert( t != Tag(0xffff, 0xffff) );
        gdcmm::DataElement de( t );
        std::generate_n( ss, len, rnd_gen() );
        de.SetVR( vr );
        de.SetByteValue( ss, (uint32_t)strlen( ss ) );
        nds.Insert( de );
    }
}
sq->AddItem( it );
// Make sure to override any UID stuff
gdcmm::UIDGenerator uid;
gdcmm::DataElement de( Tag(0x8, 0x18) ); // SOP Instance UID
de.SetVR( VR::UI );
const char *u = uid.Generate();
de.SetByteValue( u, (uint32_t)strlen( u ) );
ds.Insert( de );
de.SetTag( Tag(0x8, 0x16) ); // SOP Class UID
de.SetVR( VR::UI );
gdcmm::MediaStorage ms( gdcmm::MediaStorage::RawDataStorage );
de.SetByteValue( ms.GetString(), (uint32_t)strlen( ms.GetString() ) );
ds.Insert( de );
gdcmm::FileMetaInformation &fmi = f.GetHeader();
//fmi.SetDataSetTransferSyntax( gdcmm::TransferSyntax::ImplicitVRLittleEndian );
fmi.SetDataSetTransferSyntax( gdcmm::TransferSyntax::ExplicitVRLittleEndian );
w.SetCheckFileMetaInformation( true );
w.SetFileName( outfilename );
if( !w.Write() )
{
    return 1;
}
return 0;
}

```

## 12.70 GenFakeldentifyFile.cxx

```

/*=====
Program: GDCM (Grassroots DICOM). A DICOM library

Copyright (c) 2006-2011 Mathieu Malaterre

```



All rights reserved.  
See Copyright.txt or <http://gdcms.sourceforge.net/Copyright.html> for details.

This software is distributed WITHOUT ANY WARRANTY; without even  
the implied warranty of MERCHANTABILITY or FITNESS FOR A PARTICULAR  
PURPOSE. See the above copyright notice for more information.

```

=====*/
#include "gdcmReader.h"
#include "gdcmGlobal.h"
#include "gdcmDummyValueGenerator.h"
#include "gdcmMediaStorage.h"
#include "gdcmWriter.h"
#include "gdcmItem.h"
#include "gdcmImageReader.h"
#include "gdcmSequenceOfItems.h"
#include "gdcmAttribute.h"
#include "gdcmFile.h"
#include "gdcmTag.h"
#include "gdcmDict.h"
#include "gdcmDictEntry.h"
#include "gdcmDicts.h"
#include "gdcmTransferSyntax.h"
#include "gdcmUIDGenerator.h"
#include "gdcmAnonymizer.h"
#include <cstdlib>
#include <cstring>
gdcm::DataElement CreateFakeElement(gdcm::Tag const &tag, bool toremove)
{
    static const gdcm::Global &g = gdcm::Global::GetInstance();
    static const gdcm::Dicts &dicts = g.GetDicts();
    static const gdcm::Dict &pubdict = dicts.GetPublicDict();
    static size_t countglobal = 0;
    static std::vector<gdcm::Tag> balcptags =
        gdcm::Anonymizer::GetBasicApplicationLevelConfidentialityProfileAttributes();
    size_t count = countglobal % balcptags.size();
    const gdcm::DictEntry &dictentry = pubdict.GetDictEntry(tag);
    gdcm::DataElement de;
    de.SetTag( tag );
    using gdcm::VR;
    const VR &vr = dictentry.GetVR();
    //if( vr != VR::INVALID )
    if( vr.IsDual() )
    {
        if( vr == VR::US_SS )
        {
            de.SetVR( VR::US );
        }
        else if( vr == VR::US_SS_OW )
        {
            de.SetVR( VR::OW );
        }
        else if( vr == VR::OB_OW )
        {
            de.SetVR( VR::OB );
        }
    }
    else
    {
        de.SetVR( vr );
    }
    const char str[] = "BasicApplicationLevelConfidentialityProfileAttributes";
    const char safe[] = "This is safe to keep";
    if( de.GetVR() != VR::SQ )
    {
        if( toremove )
            de.SetByteValue( str, (uint32_t)strlen(str) );
        else
            de.SetByteValue( safe, (uint32_t)strlen(safe) );
    }
    else
    {
        // Create an item
        gdcm::Item it;
        it.SetVLToUndefined();
        gdcm::DataSet &nds = it.GetNestedDataSet();
        // Insert sequence into data set
        assert(de.GetVR() == gdcm::VR::SQ );
        gdcm::SmartPointer<gdcm::SequenceOfItems> sq = new gdcm::SequenceOfItems();
        sq->SetLengthToUndefined();
        de.SetValue(*sq);
    }
}

```

```

    de.SetVLToUndefined();
    //ds.Insert( de );
    if( !toremove )
    {
        nds.Insert( CreateFakeElement( balcptags[count], true ) );
        countglobal++;
    }
    else
    {
        gdcM::Attribute<0x0008,0x0000> at1 = { 0 }; // This element has no reason to be 'anonymized'...
        nds.Insert( at1.GetAsDataElement() );
        gdcM::Attribute<0x000a,0x0000> at2 = { 0 };
        nds.Insert( at2.GetAsDataElement() );
    }
    sq->AddItem(it);
}
return de;
}
/*
*/
int main(int argc, char *argv[])
{
    if( argc < 2 )
    {
        std::cerr << argv[0] << " output.dcm" << std::endl;
        return 1;
    }
    using gdcM::Tag;
    using gdcM::VR;
    const char *outfilename = argv[1];
    std::vector<gdcM::Tag> balcptags =
        gdcM::Anonymizer::GetBasicApplicationLevelConfidentialityProfileAttributes();
    gdcM::Writer w;
    gdcM::File &f = w.GetFile();
    gdcM::DataSet &ds = f.GetDataSet();
    // Add attribute that need to be anonymized:
    std::vector<gdcM::Tag>::const_iterator it = balcptags.begin();
    for( ; it != balcptags.end(); ++it )
    {
        ds.Insert( CreateFakeElement( *it, true ) );
    }
    // Add attribute that do NOT need to be anonymized:
    static const gdcM::Global &g = gdcM::Global::GetInstance();
    static const gdcM::Dicts &dicts = g.GetDicts();
    static const gdcM::Dict &pubdict = dicts.GetPublicDict();
    using gdcM::Dict;
    Dict::ConstIterator dictit = pubdict.Begin();
    for( ; dictit != pubdict.End(); ++dictit )
    {
        const gdcM::Tag &dicttag = dictit->first;
        if( dicttag == Tag(0x6e65,0x6146) ) break;
        //const gdcM::DictEntry &dictentry = dictit->second;
        ds.Insert( CreateFakeElement( dicttag, false ) );
    }
    ds.Remove( gdcM::Tag(0x400,0x500) );
    ds.Remove( gdcM::Tag(0x12,0x62) );
    ds.Remove( gdcM::Tag(0x12,0x63) );
    // Make sure to override any UID stuff
    gdcM::UIDGenerator uid;
    gdcM::DataElement de( Tag(0x8,0x18) ); // SOP Instance UID
    de.SetVR( VR::UI );
    const char *u = uid.Generate();
    de.SetByteValue( u, (uint32_t)strlen(u) );
    //ds.Insert( de );
    ds.Replace( de );
    de.SetTag( Tag(0x8,0x16) ); // SOP Class UID
    de.SetVR( VR::UI );
    gdcM::MediaStorage ms( gdcM::MediaStorage::RawDataStorage );
    de.SetByteValue( ms.GetString(), (uint32_t)strlen(ms.GetString()) );
    ds.Replace( de ); // replace !
    gdcM::FileMetaInformation &fmi = f.GetHeader();
    //fmi.SetDataSetTransferSyntax( gdcM::TransferSyntax::ImplicitVRLittleEndian );
    fmi.SetDataSetTransferSyntax( gdcM::TransferSyntax::ExplicitVRLittleEndian );
    w.SetCheckFileMetaInformation( true );
    w.SetFileName( outfile );
    if( !w.Write() )
    {
        return 1;
    }
    return 0;
}

```

## 12.71 GenLongSeqs.cxx

```

/*=====
Program: GDCM (Grassroots DICOM). A DICOM library

Copyright (c) 2006-2011 Mathieu Malaterre
All rights reserved.
See Copyright.txt or http://gdcm.sourceforge.net/Copyright.html for details.

This software is distributed WITHOUT ANY WARRANTY; without even
the implied warranty of MERCHANTABILITY or FITNESS FOR A PARTICULAR
PURPOSE. See the above copyright notice for more information.

=====*/
#include "gdcmReader.h"
#include "gdcmWriter.h"
#include "gdcmItem.h"
#include "gdcmImageReader.h"
#include "gdcmSequenceOfItems.h"
#include "gdcmFile.h"
#include "gdcmTag.h"
/*
 * This example is used to generate the file:
 *
 *
 * There is a flaw in the DICOM design were it is assumed that Sequence can be
 * either represented as undefined length or defined length. This should work
 * in most case, but the undefined length is a little more general and can
 * store sequence of items that a defined length cannot.
 * We need to make sure that we can store numerous Item in a SQ
 *
 * Warning: do not try to compute the group length elements !
 * Warning: You may need a 64bits machine for this example to work.
 */
int main(int argc, char *argv[])
{
    if( argc < 3 )
    {
        std::cerr << argv[0] << " input.dcm output.dcm" << std::endl;
        return 1;
    }
    const char *filename = argv[1];
    const char *outfilename = argv[2];
    gdcm::Reader reader;
    reader.SetFileName( filename );
    if( !reader.Read() )
    {
        return 1;
    }
    gdcm::File &file = reader.GetFile();
    gdcm::DataSet &ds = file.GetDataSet();
    // Create a Sequence
    gdcm::SmartPointer<gdcm::SequenceOfItems> sq = new gdcm::SequenceOfItems();
    sq->SetLengthToUndefined();
    const char owner_str[] = "GDCM CONFORMANCE TESTS";
    gdcm::DataElement owner( gdcm::Tag(0x4d4d, 0x10) );
    owner.SetByteValue( owner_str, (uint32_t)strlen( owner_str ) );
    owner.SetVR( gdcm::VR::LO );
    size_t nitems = 1000;
    nitems += std::numeric_limits<uint32_t>::max();
    for( unsigned int idx = 0; idx < nitems; ++idx )
    {
        // Create a dataelement
        //gdcm::DataElement de( gdcm::Tag(0x4d4d, 0x1002) );
        //de.SetByteValue(ptr, ptr_len);
        //de.SetVR( gdcm::VR::OB );
        // Create an item
        gdcm::Item it;
        it.SetVLToUndefined();
        //gdcm::DataSet &nds = it.GetNestedDataSet();
        //nds.Insert( owner );
        //nds.Insert( de );
        sq->AddItem(it);
    }
    // Insert sequence into data set
    gdcm::DataElement des( gdcm::Tag(0x4d4d,0x1001) );
    des.SetVR( gdcm::VR::SQ );
    des.SetValue(*sq);
    des.SetVLToUndefined();
}

```

```

ds.Insert( owner );
ds.Insert( des );
gdcm::Writer w;
w.SetFile( file );
//w.SetCheckFileMetaInformation( true );
w.SetFileName( outfilename );
if ( !w.Write() )
{
    return 1;
}
return 0;
}

```

## 12.72 GenSeqs.cxx

```

/*=====
Program: GDCM (Grassroots DICOM). A DICOM library

Copyright (c) 2006-2011 Mathieu Malaterre
All rights reserved.
See Copyright.txt or http://gdcm.sourceforge.net/Copyright.html for details.

This software is distributed WITHOUT ANY WARRANTY; without even
the implied warranty of MERCHANTABILITY or FITNESS FOR A PARTICULAR
PURPOSE. See the above copyright notice for more information.

=====*/
#include "gdcmReader.h"
#include "gdcmWriter.h"
#include "gdcmItem.h"
#include "gdcmImageReader.h"
#include "gdcmSequenceOfItems.h"
#include "gdcmFile.h"
#include "gdcmTag.h"
/*
 * This example is used to generate the file:
 *
 * gdcmConformanceTests/SequenceWithUndefinedLengthNotConvertibleToDefinedLength.dcm
 *
 * There is a flaw in the DICOM design were it is assumed that Sequence can be
 * either represented as undefined length or defined length. This should work
 * in most case, but the undefined length is a little more general and can
 * store sequence of items that a defined length cannot.
 * Deflated syntax was used in this case since this synthetic example can be
 * nicely compressed using this transfer syntax.
 *
 * Warning: do not try to compute the group length elements !
 * Warning: You may need a 64bits machine for this example to work.
 */
int main(int argc, char *argv[])
{
    if( argc < 3 )
    {
        std::cerr << argv[0] << " input.dcm output.dcm" << std::endl;
        return 1;
    }
    const char *filename = argv[1];
    const char *outfilename = argv[2];
    gdcm::Reader reader;
    reader.SetFileName( filename );
    if( !reader.Read() )
    {
        return 1;
    }
    gdcm::File &file = reader.GetFile();
    gdcm::DataSet &ds = file.GetDataSet();
    //const unsigned int nitems = 1000;
    const unsigned int ptr_len = 42; /*94967296 / nitems; */
    //assert( ptr_len == 42949672 );
    char *ptr = new char[ptr_len];
    memset( ptr, 0, ptr_len );
    // Create a Sequence
    gdcm::SmartPointer<gdcm::SequenceOfItems> sq = new gdcm::SequenceOfItems();
    sq->SetLengthToUndefined();
    const char owner_str[] = "GDCM CONFORMANCE TESTS";
    gdcm::DataElement owner( gdcm::Tag(0x4d4d, 0x10) );

```

```

owner.SetByteValue(owner_str, (uint32_t)strlen(owner_str));
owner.SetVR( gdcM::VR::LO );
for(unsigned int idx = 0; idx < 10/* nitems*/; ++idx)
{
    // Create a dataelement
    gdcM::DataElement de( gdcM::Tag(0x4d4d, 0x1002) );
    de.SetByteValue(ptr, ptr_len);
    de.SetVR( gdcM::VR::OB );
    // Create an item
    gdcM::Item it;
    it.SetVLToUndefined();
    gdcM::DataSet &nds = it.GetNestedDataSet();
    nds.Insert(owner);
    nds.Insert(de);
    sq->AddItem(it);
}
// Insert sequence into data set
gdcM::DataElement des( gdcM::Tag(0x4d4d,0x1001) );
des.SetVR(gdcM::VR::SQ);
des.SetValue(*sq);
des.SetVLToUndefined();
ds.Insert(owner);
ds.Insert(des);
gdcM::Writer w;
w.SetFile( file );
//w.SetCheckFileMetaInformation( true );
w.SetFileName( outfile );
if (!w.Write() )
{
    return 1;
}
return 0;
}

```

## 12.73 GenerateStandardSOPClasses.cxx

```

/*=====
Program: GDCM (Grassroots DICOM). A DICOM library

Copyright (c) 2006-2011 Mathieu Malaterre
All rights reserved.
See Copyright.txt or http://gdcM.sourceforge.net/Copyright.html for details.

This software is distributed WITHOUT ANY WARRANTY; without even
the implied warranty of MERCHANTABILITY or FITNESS FOR A PARTICULAR
PURPOSE. See the above copyright notice for more information.

=====*/
/*
*/
#include "gdcMDefs.h"
#include "gdcMUIDs.h"
#include "gdcMGlobal.h"
#include "gdcMMediaStorage.h"
#include "gdcMSOPClassUIDToIOD.h"
int main(int , char *[])
{
    using gdcM::MediaStorage;
    gdcM::Global& g = gdcM::Global::GetInstance();
    if( !g.LoadResourcesFiles() )
    {
        std::cerr << "Could not LoadResourcesFiles" << std::endl;
        return 1;
    }
    const gdcM::Defs &defs = g.GetDefs();
    int ret = 0;
    //std::cout << "Table B.5-1 STANDARD SOP CLASSES" << std::endl;
    std::cout << "SOP Class Name,SOP Class UID,IOD Specification (defined in PS 3.3)" << std::endl;
    gdcM::MediaStorage::MSType mst;
    for ( mst = gdcM::MediaStorage::MediaStorageDirectoryStorage; mst < gdcM::MediaStorage::MS_END;
        mst = (gdcM::MediaStorage::MSType)(mst + 1) )
    {
        const char *iod = defs.GetIODNameFromMediaStorage(mst);
        gdcM::UIDs uid;
        uid.SetFromUID( gdcM::MediaStorage::GetMSString(mst) /*mst.GetString()*/ );
        if( iod )

```

```

    {
    const char *iod_ref = gdcm::SOPClassUIDToIOD::GetIOD(uid);
    if( iod_ref )
    {
        std::string iod_ref_str = iod_ref;
        //iod_ref_str += " IOD Modules";
        //if( iod_ref_str != iod )
        {
            //std::cout << "UID: " << uid << " ";
            std::cout << "'" << uid.GetName() << "' << ", " << "'" << uid.GetString() << "' << ", " << "'" << iod << "' <<
            std::endl;
            //std::cout << "Incompatible IODs: [" << iod << "] versus ref= [" << iod_ref_str << "]" << std::endl;
            ++ret;
        }
    }
    }
}
return 0;
}

```

## 12.74 GetJPEGSamplePrecision.cxx

```

/*=====
Program: GDCM (Grassroots DICOM). A DICOM library

Copyright (c) 2006-2011 Mathieu Malaterre
All rights reserved.
See Copyright.txt or http://gdcm.sourceforge.net/Copyright.html for details.

This software is distributed WITHOUT ANY WARRANTY; without even
the implied warranty of MERCHANTABILITY or FITNESS FOR A PARTICULAR
PURPOSE. See the above copyright notice for more information.

=====*/
/*
 * This example is a little helper to detect the famous SIEMENS JPEG lossless compressed image
 * where DICOM is declared as:
 *
 * (0028,0100) US 16 # 2,1 Bits Allocated
 * (0028,0101) US 12 # 2,1 Bits Stored
 * (0028,0102) US 11 # 2,1 High Bit
 * (0028,0103) US 0 # 2,1 Pixel Representation
 *
 * But where JPEG is:
 *
 * JPEG_SOF_Parameters:
 * SamplePrecision = 16
 * nLines = 192
 * nSamplesPerLine = 192
 * nComponentsInFrame = 1
 * component 0
 * ComponentIdentifier = 1
 * HorizontalSamplingFactor = 1
 * VerticalSamplingFactor = 1
 * QuantizationTableDestinationSelector = 0
 *
 * This case is valid. One simply has to use the 16bits jpeg decoder to decode the 12bits stored image.
 * This used to be an issue in GDCM 1.2.x (fixed in GDCM 1.2.5)
 *
 * The main return 0 (no error) when the file read is actually a potential problem. At the end of the main
 * function, the jpeg stream is stored in the filename specified as second argument
 */
#include "gdcmImageReader.h"
#include "gdcmSequenceOfFragments.h"
#include "gdcmJPEGCodec.h"
#include <iostream>
#include <fstream>
int main(int argc, char *argv[])
{
    if( argc < 3 )
    {
        std::cerr << argv[0] << " input.dcm output.jpg" << std::endl;
        return 1;
    }
    const char *filename = argv[1];

```

```

const char *outfilename = argv[2];
gdcM::ImageReader reader;
reader.SetFileName( filename );
if( !reader.Read() )
{
    std::cerr << "Could not read: " << filename << std::endl;
    return 1;
}
// The output of gdcM::Reader is a gdcM::File
const gdcM::File &file = reader.GetFile();
const gdcM::Image &image = reader.GetImage();
const gdcM::TransferSyntax &ts = file.GetHeader().GetDataSetTransferSyntax();
if( ts != gdcM::TransferSyntax::JPEGLosslessProcess14 && ts != gdcM::TransferSyntax::JPEGLosslessProcess14_1 )
{
    std::cerr << "Input is not a lossless JPEG" << std::endl;
    return 1;
}
// the dataset is the the set of element we are interested in:
const gdcM::DataSet &ds = file.GetDataSet();
const gdcM::Tag rawTag(0x7fe0, 0x0010); // Default to Pixel Data
const gdcM::DataElement &pdde = ds.GetDataElement( rawTag );
const gdcM::SequenceOfFragments *sf = pdde.GetSequenceOfFragments();
if( sf )
{
    std::ofstream output(outfilename, std::ios::binary);
    sf->WriteBuffer(output);
}
else
{
    std::cerr << "Error" << std::endl;
    return 1;
}
gdcM::JPEGCodec jpeg;
std::ifstream is(outfilename, std::ios::binary);
gdcM::PixelFormat pf ( gdcM::PixelFormat::UINT8 ); // let's pretend it's a 8bits jpeg
jpeg.SetPixelFormat( pf );
gdcM::TransferSyntax ts_jpeg;
bool b = jpeg.GetHeaderInfo( is, ts_jpeg );
if( !b )
{
    return 1;
}
//jpeg.Print( std::cout );
if( jpeg.GetPixelFormat().GetBitsAllocated() != image.GetPixelFormat().GetBitsAllocated()
|| jpeg.GetPixelFormat().GetBitsStored() != image.GetPixelFormat().GetBitsStored() )
{
    std::cerr << "There is a mismatch in between DICOM declared Pixel Format and Sample Precision used in the
    JPEG stream" << std::endl;
    return 0;
}
std::cout << jpeg.GetPixelFormat() << std::endl;
std::cout << image.GetPixelFormat() << std::endl;
return 1;
}

```

## 12.75 GetSequenceUltrasound.cxx

```

/*=====
Program: GDCM (Grassroots DICOM). A DICOM library

Copyright (c) 2006-2011 Mathieu Malaterre
All rights reserved.
See Copyright.txt or http://gdcM.sourceforge.net/Copyright.html for details.

This software is distributed WITHOUT ANY WARRANTY; without even
the implied warranty of MERCHANTABILITY or FITNESS FOR A PARTICULAR
PURPOSE. See the above copyright notice for more information.
=====*/
#include "gdcMReader.h"
#include "gdcMAttribute.h"
bool Region ( char* nomefile, unsigned int* X_min, unsigned int* Y_min, unsigned int* X_max, unsigned int* Y_max
);
int main(int argc, char* argv[] )
{
    // Controllo del numero di argomenti introdotti da riga di comando

```

```

if( argc < 2 )
{
    std::cerr << "Usage: " << std::endl;
    std::cerr << argv[0] << " inputImageFile " << std::endl;
    return EXIT_FAILURE;
}
unsigned int x_min = 1;
unsigned int y_min = 1;
unsigned int x_max = 1;
unsigned int y_max = 1;
if( Region ( argv[1], &x_min, &y_min, &x_max, &y_max ) )
{
    std::cout << "x_min = " << x_min << std::endl;
    std::cout << "y_min = " << y_min << std::endl;
    std::cout << "x_max = " << x_max << std::endl;
    std::cout << "y_max = " << y_max << std::endl;
}
else
{
    std::cout << "no\n";
}
}
bool Region ( char* nomefile, unsigned int* X_min, unsigned int* Y_min, unsigned int* X_max, unsigned int* Y_max
)
{
    gdcm::Reader reader;
    reader.SetFileName( nomefile );
    if( !reader.Read() )
    {
        std::cerr << "Could not read: " << nomefile << std::endl;
        return false;
    }
    gdcm::File &file = reader.GetFile();
    gdcm::DataSet &ds = file.GetDataSet();
    gdcm::Tag tsqur(0x0018,0x6011);
    if( !ds.FindDataElement( tsqur ) )
    {
        return false;
    }
    const gdcm::DataElement &squr = ds.GetDataElement( tsqur );
    //std::cout << squr << std::endl;
    const gdcm::SequenceOfItems *sqi = squr.GetValueAsSQ();
    if( !sqi || !sqi->GetNumberOfItems() )
    {
        return false;
    }
    //std::cout << sqi << std::endl;
    const gdcm::Item &item = sqi->GetItem(1);
    //std::cout << item << std::endl;
    const gdcm::DataSet& nestedds = item.GetNestedDataSet();
    //std::cout << nestedds << std::endl;
    gdcm::Tag tX0(0x0018,0x6018);
    gdcm::Tag tY0(0x0018,0x601a);
    gdcm::Tag tX1(0x0018,0x601c);
    gdcm::Tag tY1(0x0018,0x601e);
    if( (!nestedds.FindDataElement( tX0 ))||(!nestedds.FindDataElement( tY0 ))||(!nestedds.FindDataElement( tX1
    ))||(!nestedds.FindDataElement( tY1 )) )
    {
        return false;
    }
    const gdcm::DataElement& deX0 = nestedds.GetDataElement( tX0 );
    const gdcm::DataElement& deY0 = nestedds.GetDataElement( tY0 );
    const gdcm::DataElement& deX1 = nestedds.GetDataElement( tX1 );
    const gdcm::DataElement& deY1 = nestedds.GetDataElement( tY1 );
    //std::cout << deX0 << std::endl << deY0 << std::endl << deX1 << std::endl << deY1 << std::endl;
    //const gdcm::ByteValue *bvX0 = deX0.GetByteValue();
    //const gdcm::ByteValue *bvY0 = deY0.GetByteValue();
    //const gdcm::ByteValue *bvX1 = deX1.GetByteValue();
    //const gdcm::ByteValue *bvY1 = deY1.GetByteValue();
    //std::cout << bvX0 << std::endl << bvY0 << std::endl << bvX1 << std::endl << bvY1 << std::endl;
    gdcm::Attribute<0x0018,0x6018> atX0;
    gdcm::Attribute<0x0018,0x601a> atY0;
    gdcm::Attribute<0x0018,0x601c> atX1;
    gdcm::Attribute<0x0018,0x601e> atY1;
    atX0.SetFromDataElement( deX0 );
    atY0.SetFromDataElement( deY0 );
    atX1.SetFromDataElement( deX1 );
    atY1.SetFromDataElement( deY1 );
    uint32_t X0 = atX0.GetValue();
    uint32_t Y0 = atY0.GetValue();
    uint32_t X1 = atX1.GetValue();

```



```

uint32_t Y1 = atY1.GetValue();
std::cout << X0 << std::endl << Y0 << std::endl << X1 << std::endl << Y1 << std::endl;
*X_min = static_cast<unsigned int>(X0);
*Y_min = static_cast<unsigned int>(Y0);
*X_max = static_cast<unsigned int>(X1);
*Y_max = static_cast<unsigned int>(Y1);
//std::cout << "X_min = " << *X_min << std::endl;
//std::cout << "Y_min = " << *Y_min << std::endl;
//std::cout << "X_max = " << *X_max << std::endl;
//std::cout << "Y_max = " << *Y_max << std::endl;
return true;
}

```

## 12.76 GetSubSequenceData.cxx

```

/*=====
Program: GDCM (Grassroots DICOM). A DICOM library

Copyright (c) 2006-2011 Mathieu Malaterre
All rights reserved.
See Copyright.txt or http://gdcm.sourceforge.net/Copyright.html for details.

This software is distributed WITHOUT ANY WARRANTY; without even
the implied warranty of MERCHANTABILITY or FITNESS FOR A PARTICULAR
PURPOSE. See the above copyright notice for more information.

=====*/
#include "gdcmReader.h"
#include "gdcmImage.h"
#include "gdcmImageWriter.h"
#include "gdcmDataElement.h"
#include "gdcmPrivateTag.h"
#include "gdcmUIDGenerator.h"
#include <iostream>
#include <string>
#include <map>
/*
 * This example will extract the Movie from the private group of
 * GEMS_Ultrasound_MovieGroup_001 See Attribute
 * (7fel,60,GEMS_Ultrasound_MovieGroup_001)
 *
 * The output file will be stored in 'outvid.dcm' as
 * MultiframeGrayscaleByteSecondaryCaptureImageStorage
 */
int main(int argc, char *argv[])
{
    if( argc < 2 ) return 1;
    using namespace gdcm;
    const char *filename = argv[1];
    gdcm::Reader reader;
    reader.SetFileName( filename );
    reader.Read();
    gdcm::File &file = reader.GetFile();
    gdcm::DataSet &ds = file.GetDataSet();
    const PrivateTag tseq(0x7fel,0x1,"GEMS_Ultrasound_MovieGroup_001");
    if( !ds.FindDataElement( tseq ) ) return 1;
    const DataElement& seq = ds.GetDataElement( tseq );
    SmartPointer<SequenceOfItems> sqi = seq.GetValueAsSQ();
    assert( sqi->GetNumberOfItems() == 1 );
    Item &item = sqi->GetItem(1);
    DataSet &subds = item.GetNestedDataSet();
    const PrivateTag tseq1(0x7fel,0x10,"GEMS_Ultrasound_MovieGroup_001");
    if( !subds.FindDataElement( tseq1 ) ) return 1;
    const DataElement& seq1 = subds.GetDataElement( tseq1 );
    SmartPointer<SequenceOfItems> sqi2 = seq1.GetValueAsSQ();
    //int n = sqi2->GetNumberOfItems();
    int index = 1;
    Item &item2 = sqi2->GetItem(index);
    DataSet &subds2 = item2.GetNestedDataSet();
    const PrivateTag tseq2(0x7fel,0x20,"GEMS_Ultrasound_MovieGroup_001");
    if( !subds2.FindDataElement( tseq2 ) ) return 1;
    const DataElement& seq2 = subds2.GetDataElement( tseq2 );
    // std::cout << seq2 << std::endl;
    SmartPointer<SequenceOfItems> sqi3 = seq2.GetValueAsSQ();
    size_t ni3 = sqi3->GetNumberOfItems(); (void)ni3;
    assert( sqi3->GetNumberOfItems() >= 1 );
}

```

```

Item &item3 = sqi3->GetItem(1);
DataSet &subds3 = item3.GetNestedDataSet();
const PrivateTag tseq6(0x7fel,0x26,"GEMS_Ultrasound_MovieGroup_001");
if( !subds3.FindDataElement( tseq6 ) ) return 1;
const DataElement& seq6 = subds3.GetDataElement( tseq6 );
SmartPointer<SequenceOfItems> sqi6 = seq6.GetValueAsSQ();
size_t ni6= sqi6->GetNumberOfItems();
assert( sqi6->GetNumberOfItems() >= 1 );
const PrivateTag tseq7(0x7fel,0x86,"GEMS_Ultrasound_MovieGroup_001");
int dimx = 0, dimy = 0;
for( size_t i6 = 1; i6 <= ni6; ++i6 )
{
    Item &item6 = sqi6->GetItem(i6);
    DataSet &subds6 = item6.GetNestedDataSet();
    if( subds6.FindDataElement( tseq7 ) )
    {
        Element<VR::SL, VM::VM4> el;
        el.SetFromDataElement( subds6.GetDataElement( tseq7 ) );
        std::cout << "El= " << el.GetValue() << std::endl;
        dimx = el.GetValue(0);
        dimy = el.GetValue(1);
    }
}
const PrivateTag tseq3(0x7fel,0x36,"GEMS_Ultrasound_MovieGroup_001");
if( !subds3.FindDataElement( tseq3 ) ) return 1;
const DataElement& seq3 = subds3.GetDataElement( tseq3 );
// std::cout << seq3 << std::endl;
SmartPointer<SequenceOfItems> sqi4 = seq3.GetValueAsSQ();
size_t ni4= sqi4->GetNumberOfItems();
assert( sqi4->GetNumberOfItems() >= 1 );
const PrivateTag tseq8(0x7fel,0x37,"GEMS_Ultrasound_MovieGroup_001");
const PrivateTag tseq4(0x7fel,0x43,"GEMS_Ultrasound_MovieGroup_001");
const PrivateTag tseq5(0x7fel,0x60,"GEMS_Ultrasound_MovieGroup_001");
std::vector<char> imbuffer;
int dimz = 0;
for( size_t i4 = 1; i4 <= ni4; ++i4 )
{
    Item &item4 = sqi4->GetItem(i4);
    DataSet &subds4 = item4.GetNestedDataSet();
    if( !subds4.FindDataElement( tseq8 ) ) return 1;
    const DataElement& de8 = subds4.GetDataElement( tseq8 );
    Element<VR::UL,VM::VM1> ldimz;
    ldimz.SetFromDataElement( de8 );
    dimz += ldimz.GetValue();
    if( !subds4.FindDataElement( tseq4 ) ) return 1;
    const DataElement& seq4 = subds4.GetDataElement( tseq4 );
    if( !subds4.FindDataElement( tseq5 ) ) return 1;
    const DataElement& seq5 = subds4.GetDataElement( tseq5 );
    // std::cout << seq4 << std::endl;
    // std::cout << seq5 << std::endl;
    const ByteValue *bv4 = seq4.GetByteValue();
    (void)bv4;
}
#ifdef 0
{
    std::ofstream out( "/tmp/mo4", std::ios::binary );
    out.write( bv4->GetPointer(), bv4->GetLength() );
    out.close();
}
#endif
const ByteValue *bv5 = seq5.GetByteValue();
#ifdef 0
{
    std::ofstream out( "/tmp/mo5", std::ios::binary );
    out.write( bv5->GetPointer(), bv5->GetLength() );
    out.close();
}
#endif
std::cout << bv5->GetLength() << std::endl;
imbuffer.insert( imbuffer.begin(), bv5->GetPointer(), bv5->GetPointer() + bv5->GetLength() );
}
DataElement fakedata;
fakedata.SetByteValue( &imbuffer[0], (uint32_t)imbuffer.size() );
gdcm::SmartPointer<gdcm::Image> im = new gdcm::Image;
im->SetNumberOfDimensions( 3 );
im->SetDimension(0, dimx );
im->SetDimension(1, dimy );
im->SetDimension(2, dimz );
size_t l1 = imbuffer.size();
(void)l1;
size_t l2 = im->GetBufferLength();
(void)l2;

```

```

assert( im->GetBufferLength() == imbuffer.size() );
im->SetPhotometricInterpretation( gdcm::PhotometricInterpretation::MONOCHROME2 );
im->SetDataElement( fakedata );
gdcm::ImageWriter w;
w.SetImage( *im );
DataSet &dataset = w.GetFile().GetDataSet();
gdcm::UIDGenerator uid;
gdcm::DataElement de( Tag(0x8,0x18) ); // SOP Instance UID
de.SetVR( VR:UI );
const char *u = uid.Generate();
de.SetByteValue( u, (uint32_t)strlen(u) );
//ds.Insert( de );
dataset.Replace( de );
de.SetTag( Tag(0x8,0x16) ); // SOP Class UID
de.SetVR( VR:UI );
gdcm::MediaStorage ms(
    gdcm::MediaStorage::MultiframeGrayscaleByteSecondaryCaptureImageStorage );
de.SetByteValue( ms.GetString(), (uint32_t)strlen(ms.GetString()));
dataset.Replace( de ); // replace !
w.SetFileName( "outvid.dcm" );
if( !w.Write() )
{
    return 1;
}
return 0;
}

```

## 12.77 HelloVizWorld.cxx

```

/*=====
Program: GDCM (Grassroots DICOM). A DICOM library

Copyright (c) 2006-2011 Mathieu Malaterre
All rights reserved.
See Copyright.txt or http://gdcm.sourceforge.net/Copyright.html for details.

This software is distributed WITHOUT ANY WARRANTY; without even
the implied warranty of MERCHANTABILITY or FITNESS FOR A PARTICULAR
PURPOSE. See the above copyright notice for more information.

=====*/
/*
 * Basic example for dealing with a DICOM file that contains an Image
 * (read: Pixel Data element)
 */
#include "gdcmImageReader.h"
#include "gdcmImageWriter.h"
#include "gdcmImage.h"
#include "gdcmPhotometricInterpretation.h"
#include <iostream>
int main(int argc, char *argv[])
{
    if( argc < 3 )
    {
        std::cerr << argv[0] << " input.dcm output.dcm" << std::endl;
        return 1;
    }
    const char *filename = argv[1];
    const char *outfilename = argv[2];
    // Instantiate the image reader:
    gdcm::ImageReader reader;
    reader.SetFileName( filename );
    if( !reader.Read() )
    {
        std::cerr << "Could not read: " << filename << std::endl;
        return 1;
    }
    // If we reach here, we know for sure 2 things:
    // 1. It is a valid DICOM
    // 2. And it contains an Image !
    // The output of superclass gdcm::Reader is a gdcm::File
    //gdcm::File &file = reader.GetFile();
    // The other output of gdcm::ImageReader is a gdcm::Image
    const gdcm::Image &image = reader.GetImage();
    // Let's get some property from the image:
    unsigned int ndim = image.GetNumberOfDimensions();

```

```

// Dimensions of the image:
const unsigned int *dims = image.GetDimensions();
// Origin
const double *origin = image.GetOrigin();
const gdcm::PhotometricInterpretation &pi = image.GetPhotometricInterpretation();
for(unsigned int i = 0; i < ndim; ++i)
{
    std::cout << "Dim(" << i << "): " << dims[i] << std::endl;
}
for(unsigned int i = 0; i < ndim; ++i)
{
    std::cout << "Origin(" << i << "): " << origin[i] << std::endl;
}
std::cout << "PhotometricInterpretation: " << pi << std::endl;
// Write the modified DataSet back to disk
gdcm::ImageWriter writer;
writer.SetImage( image );
writer.SetFileName( outfilename );
//writer.SetFile( file ); // We purposely NOT copy the meta information from the input
// file, and instead only pass the image
if( !writer.Write() )
{
    std::cerr << "Could not write: " << outfilename << std::endl;
    return 1;
}
return 0;
}

```

## 12.78 HelloWorld.cxx

```

/*=====
Program: GDCM (Grassroots DICOM). A DICOM library

Copyright (c) 2006-2011 Mathieu Malaterre
All rights reserved.
See Copyright.txt or http://gdcm.sourceforge.net/Copyright.html for details.

This software is distributed WITHOUT ANY WARRANTY; without even
the implied warranty of MERCHANTABILITY or FITNESS FOR A PARTICULAR
PURPOSE. See the above copyright notice for more information.

=====*/
/*
 * This example is ... guess what this is for :)
 */
#include "gdcmReader.h"
#include "gdcmWriter.h"
#include "gdcmAttribute.h"
#include <iostream>
int main(int argc, char *argv[])
{
    if( argc < 3 )
    {
        std::cerr << argv[0] << " input.dcm output.dcm" << std::endl;
        return 1;
    }
    const char *filename = argv[1];
    const char *outfilename = argv[2];
    // Instantiate the reader:
    gdcm::Reader reader;
    reader.SetFileName( filename );
    if( !reader.Read() )
    {
        std::cerr << "Could not read: " << filename << std::endl;
        return 1;
    }
    // If we reach here, we know for sure only 1 thing:
    // It is a valid DICOM file (potentially an old ACR-NEMA 1.0/2.0 file)
    // (Maybe, it's NOT a Dicom image -could be a DICOMDIR, a RTSTRUCT, etc-)
    // The output of gdcm::Reader is a gdcm::File
    gdcm::File &file = reader.GetFile();
    // the dataset is the the set of element we are interested in:
    gdcm::DataSet &ds = file.GetDataSet();
    // Construct a static(*) type for Image Comments :
    gdcm::Attribute<0x0020,0x4000> imagecomments;
    imagecomments.SetValue( "Hello, World !" );
}

```

```

// Now replace the Image Comments from the dataset with our:
ds.Replace( imagecomments.GetAsDataElement() );
// Write the modified DataSet back to disk
gdcm::Writer writer;
writer.CheckFileMetaInformationOff(); // Do not attempt to reconstruct the file meta to preserve the file
// as close to the original as possible.

writer.SetFileName( outfilename );
writer.SetFile( file );
if( !writer.Write() )
{
    std::cerr << "Could not write: " << outfilename << std::endl;
    return 1;
}
return 0;
}
/*
* (*) static type, means that extra DICOM information VR & VM are computed at compilation time.
* The compiler is deducing those values from the template arguments of the class.
*/

```

## 12.79 LargeVRDSExplicit.cxx

```

/*=====
Program: GDCM (Grassroots DICOM). A DICOM library

Copyright (c) 2006-2011 Mathieu Malaterre
All rights reserved.
See Copyright.txt or http://gdcm.sourceforge.net/Copyright.html for details.

This software is distributed WITHOUT ANY WARRANTY; without even
the implied warranty of MERCHANTABILITY or FITNESS FOR A PARTICULAR
PURPOSE. See the above copyright notice for more information.

=====*/
#include "gdcmReader.h"
#include "gdcmWriter.h"
#include "gdcmAttribute.h"
#include "gdcmFileExplicitFilter.h"
#include "gdcmSequenceOfItems.h"
bool interpolate(const double * pts, size_t npts, std::vector<double> &out )
{
    out.clear();
    for(size_t i = 0; i < 2*npts; ++i )
    {
        const size_t j = i / 2;
        if( i % 2 )
        {
            if( j != npts - 1 )
            {
                assert( 3*j+5 < 3*npts );
                const double midpointx = (pts[3*j+0] + pts[3*j+3]) / 2;
                const double midpointy = (pts[3*j+1] + pts[3*j+4]) / 2;
                const double midpointz = (pts[3*j+2] + pts[3*j+5]) / 2;
                out.push_back( midpointx );
                out.push_back( midpointy );
                out.push_back( midpointz );
            }
        }
        else
        {
            assert( j < npts );
            out.push_back( pts[3*j+0] );
            out.push_back( pts[3*j+1] );
            out.push_back( pts[3*j+2] );
        }
    }
    assert( out.size() == 2 * npts * 3 - 3 );
    return true;
}
int main(int argc, char *argv[])
{
    if( argc < 3 )
    {
        std::cerr << argv[0] << " input.dcm output.dcm" << std::endl;
        return 1;
    }
}

```

```

const char *filename = argv[1];
const char *outfilename = argv[2];
gdcm::Reader reader;
reader.SetFileName( filename );
if( !reader.Read() )
{
    return 1;
}
gdcm::File &file = reader.GetFile();
gdcm::DataSet &ds = file.GetDataSet();
gdcm::FileExplicitFilter fef;
//fef.SetChangePrivateTags( changeprivatetags );
fef.SetFile( reader.GetFile() );
if( !fef.Change() )
{
    std::cerr << "Failed to change: " << filename << std::endl;
    return 1;
}
// (3006,0039) SQ (Sequence with undefined length #=4)      # u/1, 1 ROIContourSequence
gdcm::Tag tag(0x3006,0x0039);
const gdcm::DataElement &roicsq = ds.GetDataElement( tag );
gdcm::SmartPointer<gdcm::SequenceOfItems> sqi = roicsq.GetValueAsSQ();
//sqi->SetNumberOfItems( 1 );
const gdcm::Item & item = sqi->GetItem(1); // Item start at #1
const gdcm::DataSet& nestedds = item.GetNestedDataSet();
gdcm::Tag tcsq(0x3006,0x0040);
if( !nestedds.FindDataElement( tcsq ) )
{
    return 0;
}
const gdcm::DataElement& csq = nestedds.GetDataElement( tcsq );
gdcm::SmartPointer<gdcm::SequenceOfItems> sqi2 = csq.GetValueAsSQ();
if( !sqi2 || !sqi2->GetNumberOfItems() )
{
    return 0;
}
//unsigned int nitens = sqi2->GetNumberOfItems();
gdcm::Item & item2 = sqi2->GetItem(1); // Item start at #1
gdcm::DataSet& nestedds2 = item2.GetNestedDataSet();
//item2.SetVLToUndefined();
//std::cout << nestedds2 << std::endl;
// (3006,0050) DS [43.57636\65.52504\ -10.0\46.043102\62.564945\ -10.0\49.126537\60.714... # 398,48 ContourData
gdcm::Tag tcontourdata(0x3006,0x0050);
const gdcm::DataElement & contourdata = nestedds2.GetDataElement( tcontourdata );
//std::cout << contourdata << std::endl;
//const gdcm::ByteValue *bv = contourdata.GetByteValue();
gdcm::Attribute<0x3006,0x0046> ncontourpoints;
ncontourpoints.Set( nestedds2 );
gdcm::Attribute<0x3006,0x0050> at;
at.SetFromDataElement( contourdata );
const double* pts = at.GetValues();
unsigned int npts = at.GetNumberOfValues() / 3;
std::vector<double> out( pts, pts + npts * 3 );
std::vector<double> out2;
//const unsigned int niter = 7;
const unsigned int niter = 8;
for( unsigned int i = 0; i < niter; ++i )
{
    //bool b =
    interpolate(&out[0], out.size() / 3, out2);
    //const double *pout = &out[0];
    out = out2;
    out2.clear();
}
assert( out.size() % 3 == 0 );
gdcm::Attribute<0x3006,0x0050> at_interpolate;
at_interpolate.SetNumberOfValues( (unsigned int)out.size() / 3 );
at_interpolate.SetValues( &out[0], (uint32_t)out.size() );
ncontourpoints.SetValue( at_interpolate.GetNumberOfPoints() / 3 );
nestedds2.Replace( at_interpolate.GetAsDataElement() );
nestedds2.Replace( ncontourpoints.GetAsDataElement() );
//assert(0);
// Let's take item one and subdivide it
gdcm::TransferSyntax ts = gdcm::TransferSyntax::ImplicitVRLittleEndian;
ts = gdcm::TransferSyntax::ExplicitVRLittleEndian;
gdcm::FileMetaInformation &fmi = file.GetHeader();
const char *tsuid = gdcm::TransferSyntax::GetTSString( ts );
// const char * is ok since padding is \0 anyway...
gdcm::DataElement de( gdcm::Tag(0x0002,0x0010) );
de.SetByteValue( tsuid, (uint32_t)strlen(tsuid) );
de.SetVR( gdcm::Attribute<0x0002, 0x0010>::GetVR() );

```

```

fmi.Replace( de );
fmi.Remove( gdcM::Tag(0x0002,0x0012) ); // will be regenerated
fmi.Remove( gdcM::Tag(0x0002,0x0013) ); // ' ' '
fmi.SetDataSetTransferSyntax(ts);
gdcM::Writer w;
w.SetFile( file );
w.SetFileName( outfilename );
if ( !w.Write() )
{
    return 1;
}
return 0;
}

```

## 12.80 MakeTemplate.cxx

```

/*=====
Program: GDCM (Grassroots DICOM). A DICOM library

Copyright (c) 2006-2011 Mathieu Malaterre
All rights reserved.
See Copyright.txt or http://gdcM.sourceforge.net/Copyright.html for details.

This software is distributed WITHOUT ANY WARRANTY; without even
the implied warranty of MERCHANTABILITY or FITNESS FOR A PARTICULAR
PURPOSE. See the above copyright notice for more information.

=====*/
#include "gdcMFileAnonymizer.h"
#include "gdcMReader.h"
#include "gdcMWriter.h"
int main(int argc, char *argv[])
{
    if( argc < 3 ) return 1;
    const char* filename = argv[1];
    const char* outfilename = argv[2];
    //gdcM::Trace::DebugOn();
    // Remove Pixel Data element:
    gdcM::FileAnonymizer fa;
    fa.SetInputFileName( filename );
    fa.SetOutputFileName( outfilename );
    fa.Empty( gdcM::Tag(0x7fe0,0x10) );
    // cannot replace in-place DICOM header:
    //fa.Replace( gdcM::Tag(0x2,0x2), "1.2.840.10008.5.1.4.1.1.7" );
    if( !fa.Write() )
    {
        std::cerr << "impossible to remove Pixel Data attribute" << std::endl;
        return 1;
    }
    // Update the DICOM Header:
    gdcM::Reader reader;
    reader.SetFileName( outfilename );
    if( !reader.Read() )
    {
        std::cerr << "could not read back" << std::endl;
        return 1;
    }
    gdcM::File & file = reader.GetFile();
    gdcM::FileMetaInformation &fmi = file.GetHeader();
    gdcM::TransferSyntax ts = gdcM::TransferSyntax::ImplicitVRLittleEndian;
    ts = gdcM::TransferSyntax::ExplicitVRLittleEndian;
    fmi.SetDataSetTransferSyntax(ts);
    gdcM::Writer writer;
    writer.SetFile( file );
    writer.SetFileName( outfilename ); // warning overwrite file !
    if( !writer.Write() )
    {
        std::cerr << "could not write back" << std::endl;
        return 1;
    }
    return 0;
}

```

## 12.81 MergeTwoFiles.cxx

```

/*=====
Program: GDCM (Grassroots DICOM). A DICOM library

Copyright (c) 2006-2011 Mathieu Malaterre
All rights reserved.
See Copyright.txt or http://gdcm.sourceforge.net/Copyright.html for details.

This software is distributed WITHOUT ANY WARRANTY; without even
the implied warranty of MERCHANTABILITY or FITNESS FOR A PARTICULAR
PURPOSE. See the above copyright notice for more information.
=====*/
/*
 * This example will show how one can read in two DICOM files, use the dataset
 * from file1 and use image from file2 to save it in a 3rd file.
 *
 * Eg:
 * MergeTwoFiles gdcmData/012345.002.050.dcm gdcmData/test.acr merge.dcm
 */
#include "gdcmReader.h"
#include "gdcmImageReader.h"
#include "gdcmImageWriter.h"
#include "gdcmWriter.h"
#include "gdcmDataSet.h"
#include "gdcmAttribute.h"
int main(int argc, char *argv[])
{
    if( argc < 3 )
    {
        return 1;
    }
    const char *file1 = argv[1];
    const char *file2 = argv[2];
    const char *file3 = argv[3];
    // Read file1
    gdcm::ImageReader reader1;
    reader1.SetFileName( file1 );
    if( !reader1.Read() )
    {
        return 1;
    }
    // Read file2
    gdcm::ImageReader reader2;
    reader2.SetFileName( file2 );
    if( !reader2.Read() )
    {
        return 1;
    }
    // Ok now let's take the DataSet from file1 and the Image from file2
    // Warning: if file2 is -for example- a Secondary Capture Storage, then it has no
    // Image Orientation (Patient) thus any Image Orientation (Patient) from file1
    // will be discarded...
    // let's be fancy. In case reader2 contains explicit, but reader1 is implicit
    // we would rather see an implicit output
    if( reader1.GetFile().GetHeader().GetDataSetTransferSyntax() == gdcm::TransferSyntax::ImplicitVRLittleEndian )
    {
        reader2.GetImage().SetTransferSyntax( gdcm::TransferSyntax::ImplicitVRLittleEndian );
    }
    gdcm::ImageWriter writer;
    writer.SetFileName( file3 );
    writer.SetFile( reader1.GetFile() );
    // ImageWriter will always use all of gdcm::Image information and override anything wrong from
    // reader1.GetFile(), including the Transfer Syntax
    writer.SetImage( reader2.GetImage() );
    gdcm::DataSet &ds = reader1.GetFile().GetDataSet();
    // Make sure that SOPInstanceUID are different
    // Simply removing it is sufficient as gdcm::ImageWriter will generate one by default
    // if not found.
    ds.Remove( gdcm::Tag(0x0008,0x0018) );
    if( !writer.Write() )
    {
        return 1;
    }
    return 0;
}

```



## 12.82 MrProtocol.cxx

```
/*=====
Program: GDCM (Grassroots DICOM). A DICOM library

Copyright (c) 2006-2011 Mathieu Malaterre
All rights reserved.
See Copyright.txt or http://gdcm.sourceforge.net/Copyright.html for details.

This software is distributed WITHOUT ANY WARRANTY; without even
the implied warranty of MERCHANTABILITY or FITNESS FOR A PARTICULAR
PURPOSE. See the above copyright notice for more information.

=====*/
/*
 *
 */
/*
28 - 'MrProtocol' VM 1, VR UN, SyngoDT 0, NoOfItems 6, Data '### ASCCONV BEGIN ###
ulVersion = 0xbee332
tSequenceFileName = "%SiemensSeq%\fl_fq_shphs"
tProtocolName = "flash+AF8-100+AF8-through-plane+AF8-V"
tReferenceImage0 = "1.3.12.2.1107.5.2.9.16041.30000007062106100181200004658"
tReferenceImage1 = "1.3.12.2.1107.5.2.9.16041.30000007062106100181200004635"
tReferenceImage2 = "1.3.12.2.1107.5.2.9.16041.30000007062106100181200004683"
ucScanRegionPosValid = 0x1
sProtConsistencyInfo.tBaselineString = "N4_VB11A_LATEST_20031004"
sProtConsistencyInfo.flNominalB0 = 1.494
sProtConsistencyInfo.flGMax = 22
sProtConsistencyInfo.flRiseTime = 10
sGRADSPEC.sEddyCompensationX.aflAmplitude[0] = 0.0141111
sGRADSPEC.sEddyCompensationX.aflAmplitude[1] = 0.057038
sGRADSPEC.sEddyCompensationX.aflAmplitude[2] = -0.00986504
sGRADSPEC.sEddyCompensationX.aflAmplitude[3] = 0.00247627
sGRADSPEC.sEddyCompensationX.aflAmplitude[4] = 0.0026377
sGRADSPEC.sEddyCompensationX.aflTimeConstant[0] = 1.53826
sGRADSPEC.sEddyCompensationX.aflTimeConstant[1] = 0.746617
sGRADSPEC.sEddyCompensationX.aflTimeConstant[2] = 0.339236
sGRADSPEC.sEddyCompensationX.aflTimeConstant[3] = 0.0309809
sGRADSPEC.sEddyCompensationX.aflTimeConstant[4] = 0.00067694
sGRADSPEC.sEddyCompensationY.aflAmplitude[0] = 0.0156411
sGRADSPEC.sEddyCompensationY.aflAmplitude[1] = 0.0440623
sGRADSPEC.sEddyCompensationY.aflAmplitude[2] = -0.00782663
sGRADSPEC.sEddyCompensationY.aflAmplitude[3] = 0.00186828
sGRADSPEC.sEddyCompensationY.aflAmplitude[4] = 0.00154504
sGRADSPEC.sEddyCompensationY.aflTimeConstant[0] = 1.47145
sGRADSPEC.sEddyCompensationY.aflTimeConstant[1] = 0.750538
sGRADSPEC.sEddyCompensationY.aflTimeConstant[2] = 0.339397
sGRADSPEC.sEddyCompensationY.aflTimeConstant[3] = 0.0312962
sGRADSPEC.sEddyCompensationY.aflTimeConstant[4] = 0.000895133
sGRADSPEC.sEddyCompensationZ.aflAmplitude[0] = 0.00618504
sGRADSPEC.sEddyCompensationZ.aflAmplitude[1] = 0.00313121
sGRADSPEC.sEddyCompensationZ.aflAmplitude[2] = 0.000289346
sGRADSPEC.sEddyCompensationZ.aflAmplitude[3] = -0.00019677
sGRADSPEC.sEddyCompensationZ.aflAmplitude[4] = 7.66445e-005
sGRADSPEC.sEddyCompensationZ.aflTimeConstant[0] = 3.37462
sGRADSPEC.sEddyCompensationZ.aflTimeConstant[1] = 0.999351
sGRADSPEC.sEddyCompensationZ.aflTimeConstant[2] = 0.0174646
sGRADSPEC.sEddyCompensationZ.aflTimeConstant[3] = 0.0110094
sGRADSPEC.sEddyCompensationZ.aflTimeConstant[4] = 0.00199922
sGRADSPEC.bEddyCompensationValid = 1
sGRADSPEC.sB0CompensationX.aflAmplitude[0] = 0.307474
sGRADSPEC.sB0CompensationX.aflAmplitude[1] = 0.029337
sGRADSPEC.sB0CompensationX.aflAmplitude[2] = -0.187118
sGRADSPEC.sB0CompensationX.aflTimeConstant[0] = 0.98583
sGRADSPEC.sB0CompensationX.aflTimeConstant[1] = 0.0308443
sGRADSPEC.sB0CompensationX.aflTimeConstant[2] = 0.000466792
sGRADSPEC.sB0CompensationY.aflAmplitude[0] = 0.365257
sGRADSPEC.sB0CompensationY.aflAmplitude[1] = -0.318647
sGRADSPEC.sB0CompensationY.aflAmplitude[2] = -0.0118978
sGRADSPEC.sB0CompensationY.aflTimeConstant[0] = 0.61535
sGRADSPEC.sB0CompensationY.aflTimeConstant[1] = 0.488831
sGRADSPEC.sB0CompensationY.aflTimeConstant[2] = 0.00199991
sGRADSPEC.sB0CompensationZ.aflAmplitude[0] = -0.44647
sGRADSPEC.sB0CompensationZ.aflAmplitude[1] = -0.0455154
sGRADSPEC.sB0CompensationZ.aflAmplitude[2] = -0.0304901
sGRADSPEC.sB0CompensationZ.aflTimeConstant[0] = 0.959231
sGRADSPEC.sB0CompensationZ.aflTimeConstant[1] = 0.0720189
sGRADSPEC.sB0CompensationZ.aflTimeConstant[2] = 0.00190141
```

```

sGRADSPEC.bB0CompensationValid          = 1
sGRADSPEC.sCrossTermCompensationXY.aflAmplitude[0] = 0.00105046
sGRADSPEC.sCrossTermCompensationXY.aflTimeConstant[0] = 0.842014
sGRADSPEC.sCrossTermCompensationXZ.aflAmplitude[0] = -0.00150189
sGRADSPEC.sCrossTermCompensationXZ.aflTimeConstant[0] = 0.736169
sGRADSPEC.sCrossTermCompensationYX.aflAmplitude[0] = -5.5278e-005
sGRADSPEC.sCrossTermCompensationYX.aflTimeConstant[0] = 0.228697
sGRADSPEC.sCrossTermCompensationYZ.aflAmplitude[0] = 0.000307999
sGRADSPEC.sCrossTermCompensationYZ.aflTimeConstant[0] = 1.19431
sGRADSPEC.sCrossTermCompensationZX.aflAmplitude[0] = -0.000286868
sGRADSPEC.sCrossTermCompensationZX.aflTimeConstant[0] = 0.665979
sGRADSPEC.sCrossTermCompensationZY.aflAmplitude[0] = 0.000355175
sGRADSPEC.sCrossTermCompensationZY.aflTimeConstant[0] = 0.844189
sGRADSPEC.bCrossTermCompensationValid    = 1
sGRADSPEC.lOffsetX                       = 25
sGRADSPEC.lOffsetY                       = 84
sGRADSPEC.lOffsetZ                       = 47
sGRADSPEC.bOffsetValid                   = 1
sGRADSPEC.lDelayX                       = 12
sGRADSPEC.lDelayY                       = 11
sGRADSPEC.lDelayZ                       = 9
sGRADSPEC.bDelayValid                    = 1
sGRADSPEC.flSensitivityX                 = 0.000264087
sGRADSPEC.flSensitivityY                 = 0.000272009
sGRADSPEC.flSensitivityZ                 = 0.000272677
sGRADSPEC.bSensitivityValid              = 1
sGRADSPEC.alShimCurrent[0]              = 183
sGRADSPEC.alShimCurrent[1]              = -25
sGRADSPEC.alShimCurrent[2]              = -85
sGRADSPEC.alShimCurrent[3]              = 378
sGRADSPEC.alShimCurrent[4]              = 82
sGRADSPEC.bShimCurrentValid              = 1
sGRADSPEC.ucMode                         = 0x2
sTXSPEC.asNucleusInfo[0].tNucleus       = "1H"
sTXSPEC.asNucleusInfo[0].lFrequency      = 63684693
sTXSPEC.asNucleusInfo[0].bFrequencyValid = 1
sTXSPEC.asNucleusInfo[0].flReferenceAmplitude = 359.734
sTXSPEC.asNucleusInfo[0].bReferenceAmplitudeValid = 1
sTXSPEC.asNucleusInfo[0].flAmplitudeCorrection = 1
sTXSPEC.asNucleusInfo[0].bAmplitudeCorrectionValid = 1
sTXSPEC.asNucleusInfo[1].bFrequencyValid = 1
sTXSPEC.asNucleusInfo[1].bReferenceAmplitudeValid = 1
sTXSPEC.asNucleusInfo[1].bAmplitudeCorrectionValid = 1
sTXSPEC.arFPULSE[0].tName                = "03GreFCE"
sTXSPEC.arFPULSE[0].bAmplitudeValid      = 0x1
sTXSPEC.arFPULSE[0].flAmplitude          = 147.095
sTXSPEC.arFPULSE[1].tName                = "02GreFCE"
sTXSPEC.arFPULSE[1].bAmplitudeValid      = 0x1
sTXSPEC.arFPULSE[1].flAmplitude          = 147.095
sTXSPEC.arFPULSE[2].tName                = "01GreFCE"
sTXSPEC.arFPULSE[2].bAmplitudeValid      = 0x1
sTXSPEC.arFPULSE[2].flAmplitude          = 147.095
sTXSPEC.lNoOfTraPulses                   = 3
sTXSPEC.lBTB1ParallelCapacity             = 2
sTXSPEC.lBTB1SerialCapacity              = 24
sTXSPEC.lBTB2ParallelCapacity             = 2
sTXSPEC.lBTB2SerialCapacity              = 26
sTXSPEC.bBTBValid                        = 1
sTXSPEC.flKDynMagnitudeMin                = 0.5
sTXSPEC.flKDynMagnitudeMax                = 1.5
sTXSPEC.flKDynMagnitudeClipLow            = 0.96
sTXSPEC.flKDynMagnitudeClipHigh          = 1.04
sTXSPEC.flKDynPhaseMax                    = 0.698132
sTXSPEC.flKDynPhaseClip                   = 0.174533
sTXSPEC.bKDynValid                        = 1
sTXSPEC.ucRFPulseType                     = 0x1
sTXSPEC.ucExcitMode                       = 0x1
sTXSPEC.ucSimultaneousExcitation          = 0x1
sRXSPEC.lGain                             = 1
sRXSPEC.bGainValid                        = 1
sRXSPEC.aFFT_SCALE[0].lRxChannel           = 1
sRXSPEC.aFFT_SCALE[0].flFactor            = 1.06857
sRXSPEC.aFFT_SCALE[0].bValid              = 1
sRXSPEC.aFFT_SCALE[1].lRxChannel           = 2
sRXSPEC.aFFT_SCALE[1].flFactor            = 1.07454
sRXSPEC.aFFT_SCALE[1].bValid              = 1
sRXSPEC.aFFT_SCALE[2].lRxChannel           = 3
sRXSPEC.aFFT_SCALE[2].flFactor            = 1.06622
sRXSPEC.aFFT_SCALE[2].bValid              = 1
sRXSPEC.aFFT_SCALE[3].lRxChannel           = 4
sRXSPEC.aFFT_SCALE[3].flFactor            = 1.06524

```

```

sRXSPEC.aFFT_SCALE[3].bValid           = 1
sRXSPEC.aFFT_SCALE[4].lRxChannel       = 5
sRXSPEC.aFFT_SCALE[4].flFactor         = 0.982692
sRXSPEC.aFFT_SCALE[4].bValid           = 1
sRXSPEC.aFFT_SCALE[5].lRxChannel       = 6
sRXSPEC.aFFT_SCALE[5].flFactor         = 0.988603
sRXSPEC.aFFT_SCALE[5].bValid           = 1
sRXSPEC.aFFT_SCALE[6].lRxChannel       = 7
sRXSPEC.aFFT_SCALE[6].flFactor         = 0.981538
sRXSPEC.aFFT_SCALE[6].bValid           = 1
sRXSPEC.aFFT_SCALE[7].lRxChannel       = 8
sRXSPEC.aFFT_SCALE[7].flFactor         = 1.00856
sRXSPEC.aFFT_SCALE[7].bValid           = 1
sRXSPEC.bVariCapVoltagesValid         = 1
sRXSPEC.aIDwellTime[0]                 = 8500
sAdjFreSpec.ulMode                      = 0x1
sAdjFreSpec.ucAdjWithBC                 = 0x1
sAdjTraSpec.ucAdjWithBC                 = 0x1
sAdjShimSpec.ulMode                     = 0x1
sAdjShimSpec.ucAdjWithBC               = 0x1
sAdjWatSupSpec.ulMode                   = 0x1
sAdjWatSupSpec.ucAdjWithBC             = 0x1
alTR[0]                                 = 37000
lContrasts                              = 1
alTE[0]                                 = 4000
acFlowComp[0]                           = 1
lCombinedEchoes                         = 1
sSliceArray.asSlice[0].sPosition.dSag   = 35.31199581
sSliceArray.asSlice[0].sPosition.dCor   = -8.387765754
sSliceArray.asSlice[0].sPosition.dTra   = -23.13178296
sSliceArray.asSlice[0].sNormal.dSag     = 0.771051253
sSliceArray.asSlice[0].sNormal.dCor     = 0.5863890019
sSliceArray.asSlice[0].sNormal.dTra    = -0.2482496801
sSliceArray.asSlice[0].dThickness       = 6
sSliceArray.asSlice[0].dPhaseFOV        = 187.5
sSliceArray.asSlice[0].dReadoutFOV      = 250
sSliceArray.lSize                       = 1
sSliceArray.lSag                        = 1
sSliceArray.lConc                       = 1
sSliceArray.ucMode                      = 0x1
sSliceArray.sTSat.dThickness            = 40
sSliceArray.sTSat.dGap                  = 10
sGroupArray.asGroup[0].nSize            = 1
sGroupArray.asGroup[0].dDistFact        = 0.2
sGroupArray.anMember[1]                 = -1
sGroupArray.lSize                       = 1
sGroupArray.sPSat.dThickness            = 50
sGroupArray.sPSat.dGap                  = 10
sAutoAlign.dAAMatrix[0]                 = 1
sAutoAlign.dAAMatrix[5]                 = 1
sAutoAlign.dAAMatrix[10]                = 1
sAutoAlign.dAAMatrix[15]                = 1
sNavigatorPara.ucRespComp                = 0x4
sPrepPulses.ucFatSat                    = 0x4
sPrepPulses.ucWaterSat                  = 0x4
sPrepPulses.ucInversion                  = 0x4
sPrepPulses.ucSatRecovery                = 0x1
sPrepPulses.ucFatSatMode                 = 0x2
sKSpace.lBaseResolution                  = 256
sKSpace.lPhaseEncodingLines              = 192
sKSpace.dPhaseResolution                  = 1
sKSpace.lPartitions                      = 32
sKSpace.lImagesPerSlab                   = 32
sKSpace.dSliceResolution                  = 1
sKSpace.ucPhasePartialFourier            = 0x10
sKSpace.ucSlicePartialFourier            = 0x10
sKSpace.ucAveragingMode                  = 0x2
sKSpace.ucMultiSliceMode                  = 0x1
sKSpace.ucDimension                       = 0x2
sKSpace.ucAsymmetricEchoAllowed          = 0x1
sKSpace.unReordering                     = 0x1
sFastImaging.lEPIFactor                  = 1
sFastImaging.lTurboFactor                 = 1
sFastImaging.lSegments                   = 3
sFastImaging.ulEnableRFSpooling          = 0x1
sPhysioImaging.lSignal1                  = 2
sPhysioImaging.lMethod1                  = 2
sPhysioImaging.lSignal2                  = 1
sPhysioImaging.lMethod2                  = 1
sPhysioImaging.lPhases                   = 21
sPhysioImaging.lRetroGatedImages         = 16

```

```

sPhysioImaging.sPhysioECG.lScanWindow      = 805
sPhysioImaging.sPhysioECG.lTriggerPulses  = 1
sPhysioImaging.sPhysioECG.lTriggerWindow  = 5
sPhysioImaging.sPhysioECG.lArrhythmiaDetection = 1
sPhysioImaging.sPhysioECG.lCardiacGateOnThreshold = 100000
sPhysioImaging.sPhysioECG.lCardiacGateOffThreshold = 700000
sPhysioImaging.sPhysioPulse.lTriggerPulses = 1
sPhysioImaging.sPhysioPulse.lTriggerWindow = 5
sPhysioImaging.sPhysioPulse.lCardiacGateOnThreshold = 100000
sPhysioImaging.sPhysioPulse.lCardiacGateOffThreshold = 700000
sPhysioImaging.sPhysioExt.lTriggerPulses = 1
sPhysioImaging.sPhysioExt.lTriggerWindow = 5
sPhysioImaging.sPhysioExt.lCardiacGateOnThreshold = 100000
sPhysioImaging.sPhysioExt.lCardiacGateOffThreshold = 700000
sPhysioImaging.sPhysioResp.lRespGateThreshold = 20
sPhysioImaging.sPhysioResp.lRespGatePhase = 2
sPhysioImaging.sPhysioResp.dGatingRatio = 0.3
sSpecPara.lPhaseCyclingType = 1
sSpecPara.lPhaseEncodingType = 1
sSpecPara.lRFExcitationBandwidth = 1
sSpecPara.ucRemoveOversampling = 0x1
sSpecPara.lDecouplingType = 1
sSpecPara.lNOEType = 1
sSpecPara.lExcitationType = 1
sSpecPara.lSpectralSuppression = 1
sDiffusion.ulMode = 0x1
sAngio.sFlowArray.asElm[0].nVelocity = 100
sAngio.sFlowArray.asElm[0].nDir = 0x4
sAngio.sFlowArray.lSize = 1
sAngio.ucPCFlowMode = 0x2
sAngio.ucTOFInflow = 0x4
sAngio.ucRephasedImage = 0x1
sAngio.ucPhaseImage = 0x1
sEllipticalFilter.ucMode = 0x1
sPat.lAccelFactPE = 1
sPat.lAccelFact3D = 1
sPat.ucPATMode = 0x1
sPat.ucRefScanMode = 0x1
ucAutoMovie = 0x1
ucDisableChangeStoreImages = 0x1
ucReconstructionMode = 0x1
ucPHAPSMODE = 0x1
ucDixon = 0x1
lAverages = 2
adFlipAngleDegree[0] = 30
lScanTimeSec = 103
lTotalScanTimeSec = 112
dRefSNR = 165404.1473
dRefSNR_VOI = 165404.1473
tdefaultEVAProt = "%SiemensEvaDefProt%\Inline\Inline.evp"
tcurrentEVAProt = "%CURRENTEVAPROT%\EVA2A5.tmp"
sCOIL_SELECT_MEAS.asList[0].sCoilElementID.tCoilID = "6_Ch_Body_P"
sCOIL_SELECT_MEAS.asList[0].sCoilElementID.lCoilCopy = 1
sCOIL_SELECT_MEAS.asList[0].sCoilElementID.tElement = "PP6"
sCOIL_SELECT_MEAS.asList[0].lElementSelected = 1
sCOIL_SELECT_MEAS.asList[0].lRxChannelConnected = 1
sCOIL_SELECT_MEAS.asList[1].sCoilElementID.tCoilID = "6_Ch_Body_P"
sCOIL_SELECT_MEAS.asList[1].sCoilElementID.lCoilCopy = 1
sCOIL_SELECT_MEAS.asList[1].sCoilElementID.tElement = "PP5"
sCOIL_SELECT_MEAS.asList[1].lElementSelected = 1
sCOIL_SELECT_MEAS.asList[1].lRxChannelConnected = 1
sCOIL_SELECT_MEAS.asList[2].sCoilElementID.tCoilID = "6_Ch_Body_P"
sCOIL_SELECT_MEAS.asList[2].sCoilElementID.lCoilCopy = 1
sCOIL_SELECT_MEAS.asList[2].sCoilElementID.tElement = "PP3"
sCOIL_SELECT_MEAS.asList[2].lElementSelected = 1
sCOIL_SELECT_MEAS.asList[2].lRxChannelConnected = 2
sCOIL_SELECT_MEAS.asList[3].sCoilElementID.tCoilID = "6_Ch_Body_P"
sCOIL_SELECT_MEAS.asList[3].sCoilElementID.lCoilCopy = 1
sCOIL_SELECT_MEAS.asList[3].sCoilElementID.tElement = "PP4"
sCOIL_SELECT_MEAS.asList[3].lElementSelected = 1
sCOIL_SELECT_MEAS.asList[3].lRxChannelConnected = 3
sCOIL_SELECT_MEAS.asList[4].sCoilElementID.tCoilID = "6_Ch_Body_P"
sCOIL_SELECT_MEAS.asList[4].sCoilElementID.lCoilCopy = 1
sCOIL_SELECT_MEAS.asList[4].sCoilElementID.tElement = "PP2"
sCOIL_SELECT_MEAS.asList[4].lElementSelected = 1
sCOIL_SELECT_MEAS.asList[4].lRxChannelConnected = 4
sCOIL_SELECT_MEAS.asList[5].sCoilElementID.tCoilID = "6_Ch_Body_P"
sCOIL_SELECT_MEAS.asList[5].sCoilElementID.lCoilCopy = 1
sCOIL_SELECT_MEAS.asList[5].sCoilElementID.tElement = "PP1"
sCOIL_SELECT_MEAS.asList[5].lElementSelected = 1
sCOIL_SELECT_MEAS.asList[5].lRxChannelConnected = 4

```

```

sCOIL_SELECT_MEAS.asList[6].sCoilElementID.tCoilID = "6_Ch_Body_A"
sCOIL_SELECT_MEAS.asList[6].sCoilElementID.lCoilCopy = 1
sCOIL_SELECT_MEAS.asList[6].sCoilElementID.tElement = "PA6"
sCOIL_SELECT_MEAS.asList[6].lElementSelected = 1
sCOIL_SELECT_MEAS.asList[6].lRxChannelConnected = 5
sCOIL_SELECT_MEAS.asList[7].sCoilElementID.tCoilID = "6_Ch_Body_A"
sCOIL_SELECT_MEAS.asList[7].sCoilElementID.lCoilCopy = 1
sCOIL_SELECT_MEAS.asList[7].sCoilElementID.tElement = "PA5"
sCOIL_SELECT_MEAS.asList[7].lElementSelected = 1
sCOIL_SELECT_MEAS.asList[7].lRxChannelConnected = 5
sCOIL_SELECT_MEAS.asList[8].sCoilElementID.tCoilID = "6_Ch_Body_A"
sCOIL_SELECT_MEAS.asList[8].sCoilElementID.lCoilCopy = 1
sCOIL_SELECT_MEAS.asList[8].sCoilElementID.tElement = "PA3"
sCOIL_SELECT_MEAS.asList[8].lElementSelected = 1
sCOIL_SELECT_MEAS.asList[8].lRxChannelConnected = 6
sCOIL_SELECT_MEAS.asList[9].sCoilElementID.tCoilID = "6_Ch_Body_A"
sCOIL_SELECT_MEAS.asList[9].sCoilElementID.lCoilCopy = 1
sCOIL_SELECT_MEAS.asList[9].sCoilElementID.tElement = "PA4"
sCOIL_SELECT_MEAS.asList[9].lElementSelected = 1
sCOIL_SELECT_MEAS.asList[9].lRxChannelConnected = 7
sCOIL_SELECT_MEAS.asList[10].sCoilElementID.tCoilID = "6_Ch_Body_A"
sCOIL_SELECT_MEAS.asList[10].sCoilElementID.lCoilCopy = 1
sCOIL_SELECT_MEAS.asList[10].sCoilElementID.tElement = "PA2"
sCOIL_SELECT_MEAS.asList[10].lElementSelected = 1
sCOIL_SELECT_MEAS.asList[10].lRxChannelConnected = 8
sCOIL_SELECT_MEAS.asList[11].sCoilElementID.tCoilID = "6_Ch_Body_A"
sCOIL_SELECT_MEAS.asList[11].sCoilElementID.lCoilCopy = 1
sCOIL_SELECT_MEAS.asList[11].sCoilElementID.tElement = "PA1"
sCOIL_SELECT_MEAS.asList[11].lElementSelected = 1
sCOIL_SELECT_MEAS.asList[11].lRxChannelConnected = 8
sCOIL_SELECT_MEAS.sCOILPLUGS.aulPlugId[0] = 0xff
sCOIL_SELECT_MEAS.sCOILPLUGS.aulPlugId[1] = 0x76
sCOIL_SELECT_MEAS.sCOILPLUGS.aulPlugId[2] = 0x78
sCOIL_SELECT_MEAS.sCOILPLUGS.aulPlugId[3] = 0x87
sCOIL_SELECT_MEAS.sCOILPLUGS.aulPlugId[4] = 0x67
sCOIL_SELECT_MEAS.sCOILPLUGS.auiNmbrofNibbles[0] = 0x2
sCOIL_SELECT_MEAS.sCOILPLUGS.auiNmbrofNibbles[1] = 0x2
sCOIL_SELECT_MEAS.sCOILPLUGS.auiNmbrofNibbles[2] = 0x2
sCOIL_SELECT_MEAS.sCOILPLUGS.auiNmbrofNibbles[3] = 0x2
sCOIL_SELECT_MEAS.sCOILPLUGS.auiNmbrofNibbles[4] = 0x2
sEFISPEC.bEFIDataValid = 1
### ASCCONV END ###
,
*/
/*
 * Table of equivalence:
 *
ulVersion = 0xbee332
<=>
27 - 'MrProtocolVersion' VM 1, VR IS, SyngoDT 6, NoOfItems 6, Data '12510002'
*/
#include "gdcmReader.h"
#include "gdcmImageReader.h"
#include "gdcmImageWriter.h"
#include "gdcmCSAHeader.h"
#include "gdcmAttribute.h"
#include "gdcmGlobal.h"
#include "gdcmDicts.h"
#include <map>
#include <math.h>
int main(int argc, char *argv [])
{
    if( argc < 2 ) return 1;
    const char *filename = argv[1];
    gdcm::ImageReader reader;
    reader.SetFileName( filename );
    if( !reader.Read() )
    {
        std::cerr << "Failed to read: " << filename << std::endl;
        return 1;
    }
    gdcm::CSAHeader csa;
    const gdcm::DataSet& ds = reader.GetFile().GetDataSet();
    //const gdcm::PrivateTag &t1 = csa.GetCSAImageHeaderInfoTag();
    const gdcm::PrivateTag &t2 = csa.GetCSASeriesHeaderInfoTag();
    if( ds.FindDataElement( t2 ) )
    {
        csa.LoadFromDataElement( ds.GetDataElement( t2 ) );
        //csa.Print( std::cout );
    }
    if( !csa.FindCSAElementByName( "MrProtocol" ) )

```

```

    {
        return 1;
    }
const gdcm::CSAElement &csael = csa.GetCSAElementByName( "MrProtocol" );
//std::cout << csael << std::endl;
const gdcm::ByteValue *bv = csael.GetByteValue();
if( !bv )
{
    return 1;
}
std::string str(bv->GetPointer(), bv->GetLength());
std::istream is(str);
std::string s;
typedef std::map< std::string, std::string > MyMapType;
MyMapType mymap;
while( std::getline(is, s ) )
{
    std::string::size_type pos = s.find( '=' );
    if( pos != std::string::npos )
    {
        std::string sub1 = s.substr(0, pos);
        sub1.erase( sub1.find_last_not_of(' ') + 1);
        std::string sub2 = s.substr(pos+1); // skip the '=' char
        sub2.erase( 0, sub2.find_first_not_of(' '));
        //std::cout << sub1 << std::endl;
        mymap.insert( MyMapType::value_type(sub1, sub2) );
    }
    else
    {
        // ### ASCCONV BEGIN ###
        // ### ASCCONV END ###
    }
}
const char fourierstr[] = "sKSpace.ucSlicePartialFourier";
const gdcm::CSAHeaderDict &csadict = gdcm::Global::GetInstance().GetDicts().GetCSAHeaderDict();
const gdcm::CSAHeaderDictEntry &fourier = csadict.GetCSAHeaderDictEntry( fourierstr );
std::cout << fourier << std::endl;
MyMapType::const_iterator it = mymap.find ( fourierstr );
if( it == mymap.end() ) return 1;
//std::cout << it->second << std::endl;
const std::string &partial_fourier = it->second;
if( partial_fourier == "0x1" )
{
    std::cout << "partial fourier is 4/8" << std::endl;
}
else if( partial_fourier == "0x2" )
{
    std::cout << "partial fourier is 5/8" << std::endl;
}
else if( partial_fourier == "0x4" )
{
    std::cout << "partial fourier is 6/8" << std::endl;
}
else if( partial_fourier == "0x8" )
{
    std::cout << "partial fourier is 7/8" << std::endl;
}
else if( partial_fourier == "0x10" )
{
    std::cout << "partial fourier is 8/8" << std::endl;
}
else
{
    std::cerr << "Impossible: " << partial_fourier << std::endl;
    return 1;
}
/*
This is the Flip Angle:
adFlipAngleDegree[0] = 30

```

One can find it also in the protocol:

```

...
  <ParamFuncor."<TlmapFuncor">
  {
    <Class> "<TlmapFuncor@IceImagePostProcFuncors">

    <ParamBool."<EXECUTE"> { }
    <ParamDouble."<Flip1_deg"> { <Precision> 16 14.7378520000000000 }
  }
...

```

```

*/
// Below is an attempt to play with the CSAHeader dict:
#if 0
const char gspec[] = "sGRADSPEC.flSensitivityX";
it = mymap.find( gspec );
if( it == mymap.end() ) return 1;
const std::string &dummy = it->second;
std::cout << dummy << std::endl;
const gdcm::CSAHeaderDictEntry &csaentry = csadict.GetCSAHeaderDictEntry( gspec );
std::cout << csaentry << std::endl;
#endif
/*
sSliceArray.ucMode -- should be in (1, 2, 4)
enum SeriesMode
{
    ASCENDING    = 0x01,
    DESCENDING   = 0x02,
    INTERLEAVED  = 0x04
};
*/
const char sliceorderstr[] = "sSliceArray.ucMode";
const gdcm::CSAHeaderDictEntry &sliceorder = csadict.GetCSAHeaderDictEntry( sliceorderstr );
std::cout << sliceorder << std::endl;
it = mymap.find ( sliceorderstr );
if( it == mymap.end() ) return 1;
const std::string &slice_order = it->second;
if( slice_order == "0x1" )
{
    std::cout << "slice_order: ASCENDING" << std::endl;
}
else if( slice_order == "0x2" )
{
    std::cout << "slice_order: DESCENDING" << std::endl;
}
else if( slice_order == "0x4" )
{
    std::cout << "slice_order: INTERLEAVED" << std::endl;
}
else
{
    std::cerr << "Impossible: " << slice_order << std::endl;
    return 1;
}
gdcm::MrProtocol mrprot;
if( csa.GetMrProtocol(ds, mrprot) )
{
    std::cout << mrprot << std::endl;
}
return 0;
}

```

## 12.83 PrintLUT.cxx

```

/*=====
Program: GDCM (Grassroots DICOM). A DICOM library

Copyright (c) 2006-2011 Mathieu Malaterre
All rights reserved.
See Copyright.txt or http://gdcm.sourceforge.net/Copyright.html for details.

This software is distributed WITHOUT ANY WARRANTY; without even
the implied warranty of MERCHANTABILITY or FITNESS FOR A PARTICULAR
PURPOSE. See the above copyright notice for more information.

=====*/
*/
#include "gdcmImageReader.h"
#include "gdcmImageWriter.h"
#include "gdcmImage.h"
#include "gdcmPhotometricInterpretation.h"
#include <iostream>
int main(int argc, char *argv[])
{
    if( argc < 2 )
    {

```

```

    std::cerr << argv[0] << " input.dcm" << std::endl;
    return 1;
}
const char *filename = argv[1];
// Instantiate the image reader:
gdcm::ImageReader reader;
reader.SetFileName( filename );
if( !reader.Read() )
{
    std::cerr << "Could not read: " << filename << std::endl;
    return 1;
}
const gdcm::Image &image = reader.GetImage();
const gdcm::LookupTable &lut = image.GetLUT();
lut.Print( std::cout );
return 0;
}

```

## 12.84 PublicDict.cxx

```

/*=====
Program: GDCM (Grassroots DICOM). A DICOM library

Copyright (c) 2006-2011 Mathieu Malaterre
All rights reserved.
See Copyright.txt or http://gdcm.sourceforge.net/Copyright.html for details.

This software is distributed WITHOUT ANY WARRANTY; without even
the implied warranty of MERCHANTABILITY or FITNESS FOR A PARTICULAR
PURPOSE. See the above copyright notice for more information.

=====*/
/*
 * Dummy example to show GDCM Dict(s) API (Part 6) + Collected Private Attributes:
 */
#include "gdcmGlobal.h"
#include "gdcmDicts.h"
#include "gdcmDict.h"
#include "gdcmCSAHeader.h"
#include "gdcmPrivateTag.h"
int main(int , char *[])
{
    const gdcm::Global& g = gdcm::Global::GetInstance(); // sum of all knowledge !
    const gdcm::Dicts &dicts = g.GetDicts();
    const gdcm::Dict &pub = dicts.GetPublicDict(); // Part 6
    //std::cout << pub << std::endl;
    // 3 different ways to access the same information
    // 1. From the public dict only:
    gdcm::Tag patient_name(0x10,0x10);
    const gdcm::DictEntry &entry1 = pub.GetDictEntry(patient_name);
    std::cout << entry1 << std::endl;
    // 2. From all dicts:
    const gdcm::DictEntry &entry2 = dicts.GetDictEntry(patient_name);
    std::cout << entry2 << std::endl;
    // 3. This solution is the most flexible solution as you can request using the same
    // API either a public tag or a private tag
    const char *strowner = nullptr;
    const gdcm::DictEntry &entry3 = dicts.GetDictEntry(patient_name,strowner);
    std::cout << entry3 << std::endl;
    // Private attributes:
    // try with a private tag now:
    const gdcm::PrivateTag &private_tag = gdcm::CSAHeader::GetCSAImageHeaderInfoTag();
    //std::cout << private_tag << std::endl;
    const gdcm::DictEntry &entry4 = dicts.GetDictEntry(private_tag,private_tag.GetOwner());
    std::cout << entry4 << std::endl;
    // Let's pretend that private lookup is on 0x10xx elements:
    gdcm::PrivateTag dummy = private_tag;
    dummy.SetElement( (uint16_t)(0x1000 + dummy.GetElement()) );
    const gdcm::DictEntry &entry5 = dicts.GetDictEntry(dummy,dummy.GetOwner());
    std::cout << entry5 << std::endl;
    return 0;
}

```



## 12.85 QIDO-RS.cxx

```

/*=====
Program: GDCM (Grassroots DICOM). A DICOM library

Copyright (c) 2006-2011 Mathieu Malaterre
All rights reserved.
See Copyright.txt or http://gdcml.sourceforge.net/Copyright.html for details.

This software is distributed WITHOUT ANY WARRANTY; without even
the implied warranty of MERCHANTABILITY or FITNESS FOR A PARTICULAR
PURPOSE. See the above copyright notice for more information.

=====*/
#include "gdcmlReader.h"
#include "gdcmlWriter.h"
#include "gdcmlJSON.h"
/*
 * Simple QIDO-RS round-trip to test implementation of gdcml::JSON
 * See Supl66 for details
 */
int main(int argc, char *argv[])
{
    if( argc < 2 ) return 1;
    using namespace gdcml;
    const char *filename = argv[1];
    gdcml::Reader reader;
    reader.SetFileName( filename );
    if( !reader.Read() ) return 1;
    gdcml::JSON json;
    json.PrettyPrintOn();
    std::stringstream ss;
    const gdcml::File & f = reader.GetFile();
    json.Code( f.GetDataSet(), ss);
    std::cout << ss.str() << std::endl;
    gdcml::Writer w;
    gdcml::File & ff = w.GetFile();
    ff.GetHeader().SetDataSetTransferSyntax( gdcml::TransferSyntax::ExplicitVRLittleEndian );
    if( !json.Decode(ss, ff.GetDataSet() ) )
    {
        std::cerr << "Could not decode" << std::endl;
        return 1;
    }
    w.SetFileName( "/tmp/debug.dcm" );
    if( !w.Write() ) return 1;
    return 0;
}

```

## 12.86 ReadAndDumpDICOMDIR.cxx

```

/*=====
Program: GDCM (Grassroots DICOM). A DICOM library

Copyright (c) 2006-2011 Mathieu Malaterre
All rights reserved.
See Copyright.txt or http://gdcml.sourceforge.net/Copyright.html for details.

This software is distributed WITHOUT ANY WARRANTY; without even
the implied warranty of MERCHANTABILITY or FITNESS FOR A PARTICULAR
PURPOSE. See the above copyright notice for more information.

=====*/
/*
 * This example shows how to read and dump a DICOMDIR File
 *
 * Thanks:
 * Tom Marynowski (lordglub gmail) for contributing this example
 */
#include "gdcmlReader.h"
#include "gdcmlMediaStorage.h"
typedef std::set<gdcml::DataElement> DataElementSet;
typedef DataElementSet::const_iterator ConstIterator;
int main(int argc, char *argv [])
{
    if( argc < 2 ) return 1;

```

```

const char *filename = argv[1];
gdcm::Reader reader;
reader.SetFileName( filename);
if( !reader.Read() )
{
    std::cerr << "Could not read: " << filename << std::endl;
    return 1;
}
std::stringstream strm;
gdcm::File &file = reader.GetFile();
gdcm::DataSet &ds = file.GetDataSet();
gdcm::FileMetaInformation &fmi = file.GetHeader();
gdcm::MediaStorage ms;
ms.SetFromFile(file);
if( ms != gdcm::MediaStorage::MediaStorageDirectoryStorage )
{
    std::cout << "This file is not a DICOMDIR" << std::endl;
    return 1;
}
if (fmi.FindDataElement( gdcm::Tag (0x0002, 0x0002)))
{
    strm.str("");
    fmi.GetDataElement( gdcm::Tag (0x0002, 0x0002) ).GetValue().Print(strm);
}
else
{
    std::cerr << " Media Storage Sop Class UID not present" << std::endl;
}
//TODO il faut trimer strm.str() avant la comparaison au cas ou...
if ("1.2.840.10008.1.3.10"!=strm.str())
{
    std::cout << "This file is not a DICOMDIR" << std::endl;
    return 1;
}
ConstIterator it = ds.GetDES().begin();
for( ; it != ds.GetDES().end(); ++it)
{
    if (it->GetTag()==gdcm::Tag (0x0004, 0x1220))
    {
        const gdcm::DataElement &de = (*it);
        // ne pas utiliser GetSequenceOfItems pour extraire les items
        gdcm::SmartPointer<gdcm::SequenceOfItems> sqi =de.GetValueAsSQ();
        unsigned int itemused = 1;
        while (itemused<=sqi->GetNumberOfItems())
        {
            strm.str("");
            if (sqi->GetItem(itemused).FindDataElement(gdcm::Tag (0x0004, 0x1430)))
                sqi->GetItem(itemused).GetDataElement(gdcm::Tag (0x0004, 0x1430)).GetValue().Print(strm);
            //TODO il faut trimer strm.str() avant la comparaison
            while((strm.str()=="PATIENT")||((strm.str()=="PATIENT ")))
            {
                std::cout << strm.str() << std::endl;
                strm.str("");
                if (sqi->GetItem(itemused).FindDataElement(gdcm::Tag (0x0010, 0x0010)))
                    sqi->GetItem(itemused).GetDataElement(gdcm::Tag (0x0010, 0x0010)).GetValue().Print(strm);
                std::cout << "PATIENT NAME : " << strm.str() << std::endl;
                //PATIENT ID
                strm.str("");
                if (sqi->GetItem(itemused).FindDataElement(gdcm::Tag (0x0010, 0x0020)))
                    sqi->GetItem(itemused).GetDataElement(gdcm::Tag (0x0010, 0x0020)).GetValue().Print(strm);
                std::cout << "PATIENT ID : " << strm.str() << std::endl;
                /*ADD TAG TO READ HERE*/
                std::cout << "===== " << std::endl;
                itemused++;
                strm.str("");
                if (sqi->GetItem(itemused).FindDataElement(gdcm::Tag (0x0004, 0x1430)))
                    sqi->GetItem(itemused).GetDataElement(gdcm::Tag (0x0004, 0x1430)).GetValue().Print(strm);
                //TODO il faut trimer strm.str() avant la comparaison
                while((strm.str()=="STUDY")||((strm.str()=="STUDY ")))
                {
                    std::cout << " " << strm.str() << std::endl;
                    //UID
                    strm.str("");
                    if (sqi->GetItem(itemused).FindDataElement(gdcm::Tag (0x0020, 0x000d)))
                        sqi->GetItem(itemused).GetDataElement(gdcm::Tag (0x0020, 0x000d)).GetValue().Print(strm);
                    std::cout << "          STUDY UID : " << strm.str() << std::endl;
                    //STUDY DATE
                    strm.str("");
                    if (sqi->GetItem(itemused).FindDataElement(gdcm::Tag (0x0008, 0x0020)))
                        sqi->GetItem(itemused).GetDataElement(gdcm::Tag (0x0008, 0x0020)).GetValue().Print(strm);
                    std::cout << "          STUDY DATE : " << strm.str() << std::endl;
                    //STUDY DESCRIPTION
                }
            }
        }
    }
}

```

```

strm.str("");
if (sqi->GetItem(itemused).FindDataElement(gdcm::Tag (0x0008, 0x1030)))
    sqi->GetItem(itemused).GetDataElement(gdcm::Tag (0x0008, 0x1030)).GetValue().Print(strm);
std::cout << "        STUDY DESCRIPTION : " << strm.str() << std::endl;
/*ADD TAG TO READ HERE*/
std::cout << "        " << "===== " << std::endl;
itemused++;
strm.str("");
if (sqi->GetItem(itemused).FindDataElement(gdcm::Tag (0x0004, 0x1430)))
    sqi->GetItem(itemused).GetDataElement(gdcm::Tag (0x0004, 0x1430)).GetValue().Print(strm);
//TODO il faut trimer strm.str() avant la comparaison
while((strm.str()=="SERIES")||((strm.str()=="SERIES ")))
{
    std::cout << "        " << strm.str() << std::endl;
    strm.str("");
    if (sqi->GetItem(itemused).FindDataElement(gdcm::Tag (0x0020, 0x000e)))
        sqi->GetItem(itemused).GetDataElement(gdcm::Tag (0x0020, 0x000e)).GetValue().Print(strm);
    std::cout << "        SERIE UID" << strm.str() << std::endl;
    //SERIE MODALITY
    strm.str("");
    if (sqi->GetItem(itemused).FindDataElement(gdcm::Tag (0x0008, 0x0060)))
        sqi->GetItem(itemused).GetDataElement(gdcm::Tag (0x0008, 0x0060)).GetValue().Print(strm);
    std::cout << "        SERIE MODALITY" << strm.str() << std::endl;
    //SERIE DESCRIPTION
    strm.str("");
    if (sqi->GetItem(itemused).FindDataElement(gdcm::Tag (0x0008, 0x103e)))
        sqi->GetItem(itemused).GetDataElement(gdcm::Tag (0x0008, 0x103e)).GetValue().Print(strm);
    std::cout << "        SERIE DESCRIPTION" << strm.str() << std::endl;
    /*ADD TAG TO READ HERE*/
    std::cout << "        " << "===== " << std::endl;
    itemused++;
    strm.str("");
    if (sqi->GetItem(itemused).FindDataElement(gdcm::Tag (0x0004, 0x1430)))
        sqi->GetItem(itemused).GetDataElement(gdcm::Tag (0x0004, 0x1430)).GetValue().Print(strm);
    //TODO il faut trimer strm.str() avant la comparaison
    while ((strm.str()=="IMAGE")||((strm.str()=="IMAGE ")))
        // if(tmp=="IMAGE")
        {
            std::cout << "        " << strm.str() << std::endl;
            //UID
            strm.str("");
            if (sqi->GetItem(itemused).FindDataElement(gdcm::Tag (0x0004, 0x1511)))
                sqi->GetItem(itemused).GetDataElement(gdcm::Tag (0x0004, 0x1511)).GetValue().Print(strm);
            std::cout << "        IMAGE UID : " << strm.str() << std::endl;
            //PATH de l'image
            strm.str("");
            if (sqi->GetItem(itemused).FindDataElement(gdcm::Tag (0x0004, 0x1500)))
                sqi->GetItem(itemused).GetDataElement(gdcm::Tag (0x0004, 0x1500)).GetValue().Print(strm);
            std::cout << "        IMAGE PATH : " << strm.str() << std::endl;
            /*ADD TAG TO READ HERE*/
            if(itemused < sqi->GetNumberOfItems())
                {itemused++;}
            else{break;}
            strm.str("");
            if (sqi->GetItem(itemused).FindDataElement(gdcm::Tag (0x0004, 0x1430)))
                sqi->GetItem(itemused).GetDataElement(gdcm::Tag (0x0004, 0x1430)).GetValue().Print(strm);
        }
    }
}
itemused++;
}
}
return 0;
}

```

## 12.87 ReadAndDumpDICOMDIR2.cxx

```

/*=====
Program: GDICM (Grassroots DICOM). A DICOM library

Copyright (c) 2006-2017 Mathieu Malaterre
All rights reserved.
See Copyright.txt or http://gdcm.sourceforge.net/Copyright.html for details.

```

This software is distributed WITHOUT ANY WARRANTY; without even the implied warranty of MERCHANTABILITY or FITNESS FOR A PARTICULAR PURPOSE. See the above copyright notice for more information.

```

=====*/
/*
 * This example shows how to read and dump a DICOMDIR File
 *
 * Thanks:
 * Tom Marynowski (lordglub gmail) for contributing the original
 * ReadAndDumpDICOMDIR.cxx example
 * Mihail Isakov for contributing offset calculation code here:
 * https://sourceforge.net/p/gdcm/mailman/gdcm-developers/?viewmonth=201707&viewday=15
 * Tod Baudais for combining the above and cleaning up this example
 */
#include <string>
#include <unordered_map>
#include <iostream>
#include <memory>
#include "gdcmReader.h"
#include "gdcmAttribute.h"
#include "gdcmDirectory.h"
//=====
//=====
#define TAG_MEDIA_STORAGE_SOP_CLASS_UID 0x0002,0x0002
#define TAG_DIRECTORY_RECORD_SEQUENCE 0x0004,0x1220
#define TAG_DIRECTORY_RECORD_TYPE 0x0004,0x1430
#define TAG_PATIENTS_NAME 0x0010,0x0010
#define TAG_PATIENT_ID 0x0010,0x0020
#define TAG_STUDY_DATE 0x0008,0x0020
#define TAG_STUDY_DESCRIPTION 0x0008,0x1030
#define TAG_MODALITY 0x0008,0x0060
#define TAG_SERIES_DESCRIPTION 0x0008,0x103E
#define TAG_REFERENCED_FILE_ID 0x0004,0x1500
#define TAG_REFERENCED_LOWER_LEVEL_DIRECTORY_ENTITY_OFFSET 0x0004,0x1420
#define TAG_NEXT_DIRECTORY_RECORD_OFFSET 0x0004,0x1400
//=====
// Some handy utility functions
//=====
std::string left_trim(const std::string &s) {
    std::string ss(s);
    ss.erase(ss.begin(), std::find_if(ss.begin(), ss.end(), std::not1(std::ptr_fun<int, int>(std::isspace))));
    return ss;
}
std::string right_trim(const std::string &s) {
    std::string ss(s);
    ss.erase(std::find_if(ss.rbegin(), ss.rend(), std::not1(std::ptr_fun<int, int>(std::isspace))).base(),
              ss.end());
    return ss;
}
std::string trim(const std::string &s) {
    return left_trim(right_trim(s));
}
//=====
// This code could be put in a header file somewhere
//=====
class DICOMDIRReader {
public:
    DICOMDIRReader() {}
    DICOMDIRReader(const DICOMDIRReader &rhs) = delete;
    DICOMDIRReader(DICOMDIRReader &&rhs) = delete;
    DICOMDIRReader & operator = (const DICOMDIRReader &rhs) = delete;
    DICOMDIRReader & operator = (DICOMDIRReader &&rhs) = delete;
    virtual ~DICOMDIRReader() {}

public:
    struct Common {
        int64_t child_offset;
        int64_t sibling_offset;
    };
    struct Image: public Common {
        std::string path;
    };
    struct Series: public Common {
        std::string modality;
        std::string description;
        std::vector<std::shared_ptr<Image>> children;
    };
    struct Study: public Common {
        std::string date;
        std::string description;
        std::vector<std::shared_ptr<Series>> children;
    };
};

```

```

};
struct Patient: public Common {
    std::string name;
    std::string id;
    std::vector<std::shared_ptr<Study>> children;
};
struct Other: public Common {
};
const std::vector<std::shared_ptr<Patient>& load (const std::string &path);
const std::vector<std::shared_ptr<Patient>& patients (void) { return _patients; }
private:
template <class T>
std::string get_string (const T &ds, const gdcm::Tag &tag)
{
    std::stringstream strm;
    if (ds.FindDataElement(tag)) {
        auto &de = ds.GetDataElement(tag);
        if (!de.IsEmpty() && !de.IsUndefinedLength())
            de.GetValue().Print(strm);
    }
    return trim(strm.str());
}
template <class P, class C, class O>
void reassemble_hierarchy (P &parent_offsets, C &child_offsets, O &other_offsets)
{
    for (auto &parent : parent_offsets) {
        int64_t sibling_offset;
        auto c = child_offsets[parent.second->child_offset];
        if (!c) {
            auto o = other_offsets[parent.second->child_offset];
            if (!o) {
                continue;
            } else {
                sibling_offset = o->sibling_offset;
            }
        } else {
            parent.second->children.push_back(c);
            sibling_offset = c->sibling_offset;
        }
        // Get all siblings
        while (sibling_offset) {
            c = child_offsets[sibling_offset];
            if (!c) {
                auto o = other_offsets[sibling_offset];
                if (!o) {
                    break;
                } else {
                    sibling_offset = o->sibling_offset;
                }
            } else {
                parent.second->children.push_back(c);
                sibling_offset = c->sibling_offset;
            }
        }
    }
}
std::vector<std::shared_ptr<Patient>> _patients;
};
//=====
// This code could be put in an implementation file somewhere
//=====
const std::vector<std::shared_ptr<DICOMDIRReader::Patient>& DICOMDIRReader::load (const std::string &path)
{
    _patients.clear();
    //
    // Read the dataset from the DICOMDIR file
    //
    gdcm::Reader reader;
    reader.SetFileName(path.c_str());
    if(!reader.Read()) {
        throw std::runtime_error("Unable to read file");
    }
    // Retrieve information from file
    auto &file = reader.GetFile();
    auto &data_set = file.GetDataSet();
    auto &file_meta_information = file.GetHeader();
    // Retrieve and check the Media Storage class from file
    gdcm::MediaStorage media_storage;
    media_storage.SetFromFile(file);
    if(media_storage != gdcm::MediaStorage::MediaStorageDirectoryStorage) {
        throw std::runtime_error("This file is not a DICOMDIR");
    }
}

```

```

}
auto media_storage_sop_class_uid = get_string(file_meta_information,
    gdcm::Tag(TAG_MEDIA_STORAGE_SOP_CLASS_UID));
// Make sure we have a DICOMDIR file
if (media_storage_sop_class_uid != "1.2.840.10008.1.3.10") {
    throw std::runtime_error("This file is not a DICOMDIR");
}
//
// Offset to first item courtesy of Mihail Isakov
//
gdcm::VL first_item_offset = 0;
auto it = data_set.Begin();
for(; it != data_set.End() && it->GetTag() != gdcm::Tag(TAG_DIRECTORY_RECORD_SEQUENCE); ++it) {
    first_item_offset += it->GetLength<gdcm::ExplicitDataElement>();
}
// Tag (4 bytes)
first_item_offset += it->GetTag().GetLength();
// VR field
first_item_offset += it->GetVR().GetLength();
// VL field
// For Explicit VR: adventitiously VL field length = VR field length,
// for SQ 4 bytes:
// http://dicom.nema.org/medical/dicom/current/output/html/part05.html#table_7.1-1
first_item_offset += it->GetVR().GetLength();
//
// Iterate all data elements
//
// For each item in data set
for(auto data_element : data_set.GetDES()) {
    // Only look at Directory sequence
    if (data_element.GetTag() != gdcm::Tag(TAG_DIRECTORY_RECORD_SEQUENCE))
        continue;
    auto item_sequence = data_element.GetValueAsSQ();
    auto num_items = item_sequence->GetNumberOfItems();
    //
    // Compute an offset table
    //
    // Start calculation of offset to each item courtesy of Mihail Isakov
    std::vector<int64_t> item_offsets(num_items+1);
    item_offsets[0] = file_meta_information.GetFullLength() + static_cast<int64_t>(first_item_offset);
    //
    // Extract out all of the items
    //
    std::unordered_map<int64_t, std::shared_ptr<Patient>> patient_offsets;
    std::unordered_map<int64_t, std::shared_ptr<Study>> study_offsets;
    std::unordered_map<int64_t, std::shared_ptr<Series>> series_offsets;
    std::unordered_map<int64_t, std::shared_ptr<Image>> image_offsets;
    std::unordered_map<int64_t, std::shared_ptr<Other>> other_offsets;
    for (uint32_t item_index = 1; item_index <= num_items; ++item_index) {
        auto &item = item_sequence->GetItem(item_index);
        // Add offset for item to offset table
        item_offsets[item_index] = item_offsets[item_index-1] + item.GetLength<gdcm::ExplicitDataElement>();
        // Child offset
        gdcm::Attribute<TAG_REFERENCED_LOWER_LEVEL_DIRECTORY_ENTITY_OFFSET> child_offset;
        child_offset.SetFromDataElement(item.GetDataElement(gdcm::Tag
            (TAG_REFERENCED_LOWER_LEVEL_DIRECTORY_ENTITY_OFFSET)));
        // Sibling offset
        gdcm::Attribute<TAG_NEXT_DIRECTORY_RECORD_OFFSET> sibling_offset;
        sibling_offset.SetFromDataElement(item.GetDataElement(gdcm::Tag
            (TAG_NEXT_DIRECTORY_RECORD_OFFSET)));
        // Record Type
        auto record_type = trim(get_string(item, gdcm::Tag (TAG_DIRECTORY_RECORD_TYPE)));
        // std::cout << "record_type " << record_type << " at " << item_offsets[item_index-1] << std::endl;
        // std::cout << " child_offset " << child_offset.GetValue() << std::endl;
        // std::cout << " sibling_offset " << sibling_offset.GetValue() << std::endl;
        // Extract patient information
        if (record_type == "PATIENT") {
            auto patient = std::make_shared<Patient>();
            patient->name = get_string(item, gdcm::Tag (TAG_PATIENTS_NAME));
            patient->id = get_string(item, gdcm::Tag (TAG_PATIENT_ID));
            patient->child_offset = child_offset.GetValue();
            patient->sibling_offset = sibling_offset.GetValue();
            patient_offsets[item_offsets[item_index-1]] = patient;
        }
        // Extract study information
    } else if (record_type == "STUDY") {
        auto study = std::make_shared<Study>();
        study->date = get_string(item, gdcm::Tag (TAG_STUDY_DATE));
        study->description = get_string(item, gdcm::Tag (TAG_STUDY_DESCRIPTION));
        study->child_offset = child_offset.GetValue();
        study->sibling_offset = sibling_offset.GetValue();
        study_offsets[item_offsets[item_index-1]] = study;
    }
}

```

```

    // Extract series information
} else if (record_type == "SERIES") {
    auto series = std::make_shared<Series>();
    series->modality = get_string(item, gdcmm::Tag (TAG_MODALITY));
    series->description = get_string(item, gdcmm::Tag (TAG_SERIES_DESCRIPTION));
    series->child_offset = child_offset.GetValue();
    series->sibling_offset = sibling_offset.GetValue();
    series_offsets[item_offsets[item_index-1]] = series;
// Extract image information
} else if (record_type == "IMAGE") {
    auto image = std::make_shared<Image>();
    image->path = get_string(item, gdcmm::Tag (TAG_REFERENCED_FILE_ID));
    image->child_offset = child_offset.GetValue();
    image->sibling_offset = sibling_offset.GetValue();
    image_offsets[item_offsets[item_index-1]] = image;
} else {
    auto other = std::make_shared<Other>();
    other->child_offset = child_offset.GetValue();
    other->sibling_offset = sibling_offset.GetValue();
    other_offsets[item_offsets[item_index-1]] = other;
}
}
// Check validity
if (patient_offsets.size() == 0)
    throw std::runtime_error("Unable to find patient record");
reassemble_hierarchy(series_offsets, image_offsets, other_offsets);
reassemble_hierarchy(study_offsets, series_offsets, other_offsets);
reassemble_hierarchy(patient_offsets, study_offsets, other_offsets);
// Set the new root
for (auto &patient : patient_offsets) {
    _patients.push_back(patient.second);
}
}
return _patients;
}
//=====
// Quick test
//=====
int main(int argc, const char *argv[]) {
    DICOMDIRReader reader;
    try {
        if (argc != 2)
            throw std::runtime_error("Wrong number of arguments");
        auto &patients = reader.load(argv[1]);
        for (auto &patient : patients) {
            std::cout << "PATIENT" << std::endl;
            std::cout << "NAME: " << patient->name << std::endl;
            std::cout << "ID: " << patient->id << std::endl;
            int x = 0;
            for (auto &study : patient->children) {
                std::cout << "    STUDY" << std::endl;
                std::cout << "        DESCRIPTION: " << study->description << std::endl;
                std::cout << "        DATE: " << study->date << std::endl;
                for (auto &series : study->children) {
                    x+=1;
                    std::cout << "            SERIES " << x << std::endl;
                    std::cout << "            DESCRIPTION: " << series->description << std::endl;
                    std::cout << "            MODALITY: " << series->modality << std::endl;
                    for (auto &image : series->children) {
                        std::cout << "                IMAGE PATH: " << image->path << std::endl;
                    }
                }
            }
        }
    }
    catch (...) {
        // TODO handle this
        return EXIT_FAILURE;
    }
    return EXIT_SUCCESS;
}

```

## 12.88 ReadAndPrintAttributes.cxx

```

/*=====
Program: GDCM (Grassroots DICOM). A DICOM library

```

Copyright (c) 2006–2011 Mathieu Malaterre  
 All rights reserved.  
 See Copyright.txt or <http://gdcm.sourceforge.net/Copyright.html> for details.

This software is distributed WITHOUT ANY WARRANTY; without even  
 the implied warranty of MERCHANTABILITY or FITNESS FOR A PARTICULAR  
 PURPOSE. See the above copyright notice for more information.

```

=====*/
/*
 * This small example will show how one can read and print
 * a DICOM Attribute using different technique (by tag or by name)
 */
#include "gdcmReader.h"
#include "gdcmGlobal.h"
#include "gdcmDicts.h"
#include "gdcmDict.h"
#include "gdcmAttribute.h"
#include "gdcmStringFilter.h"
#include <iostream>
int main(int argc, char *argv[])
{
  if( argc < 2 )
  {
    std::cerr << argv[0] << " input.dcm" << std::endl;
    return 1;
  }
  const char *filename = argv[1];
  // Instantiate the reader:
  gdcm::Reader reader;
  reader.SetFileName( filename );
  if( !reader.Read() )
  {
    std::cerr << "Could not read: " << filename << std::endl;
    return 1;
  }
  // The output of gdcm::Reader is a gdcm::File
  gdcm::File &file = reader.GetFile();
  // the dataset is the the set of element we are interested in:
  gdcm::DataSet &ds = file.GetDataSet();
  const gdcm::Global& g = gdcm::Global::GetInstance();
  const gdcm::Dicts &dicts = g.GetDicts();
  const gdcm::Dict &pubdict = dicts.GetPublicDict();
  using namespace gdcm;
  // In this example we will show why using name to lookup attribute can be
  // dangerous.
  Tag tPatientName(0x0,0x0);
  //const DictEntry &del =
  pubdict.GetDictEntryByName("Patient Name", tPatientName);
  std::cout << "Found: " << tPatientName << std::endl;
  // Indeed the attribute could not be found. Since DICOM 2003, Patient Name
  // has become Patient's Name.
  Tag tPatientsName;
  //const DictEntry &de2 =
  pubdict.GetDictEntryByName("Patient's Name", tPatientsName);
  std::cout << "Found: " << tPatientsName << std::endl;
  // Let's try to read an arbitrary DICOM Attribute:
  Tag tDoseGridScaling;
  //const DictEntry &de3 =
  pubdict.GetDictEntryByName("Dose Grid Scaling", tDoseGridScaling);
  std::cout << "Found: " << tDoseGridScaling << std::endl;
  if( ds.FindDataElement( tDoseGridScaling ) )
  {
    gdcm::StringFilter sf;
    sf.SetFile(file);
    std::cout << "Attribute Value as String: " << sf.ToString( tDoseGridScaling ) << std::endl;
    // Let's check the name again:
    std::pair<std::string, std::string> pss
      = sf.ToStringPair( tDoseGridScaling );
    std::cout << "Attribute Name Checked: " << pss.first << std::endl;
    std::cout << "Attribute Value (string): " << pss.second << std::endl;
    //const DataElement &dgs = ds.GetDataElement( tDoseGridScaling );
    // Let's assume for a moment we knew the tag number:
    Attribute<0x3004,0x000e> at;
    assert( at.GetTag() == tDoseGridScaling );
    at.SetFromDataSet( ds );
    // For the sake of long term maintenance, we will not write
    // that this particular attribute is stored as a double. What if
    // a user made a mistake. It is much safer to rely on GDCM internal
    // mechanism to deduce the VR::DS type (represented as a ieee double)
  }
}

```



```

    Attribute<0x3004,0x000e>::ArrayType v = at.GetValue();
    std::cout << "DoseGridScaling=" << v << std::endl;
}
return 0;
}

```

## 12.89 ReadExplicitLengthSQIVR.cxx

```

/*=====
Program: GDCM (Grassroots DICOM). A DICOM library

Copyright (c) 2006-2011 Mathieu Malaterre
All rights reserved.
See Copyright.txt or http://gdcmlib.sourceforge.net/Copyright.html for details.

This software is distributed WITHOUT ANY WARRANTY; without even
the implied warranty of MERCHANTABILITY or FITNESS FOR A PARTICULAR
PURPOSE. See the above copyright notice for more information.

=====*/
#include "gdcmlib/gdcmReader.h"
#include "gdcmlib/gdcmImplicitDataElement.h"
#include "gdcmlib/gdcmDataSet.h"
#include "gdcmlib/gdcmPrivateTag.h"
#include "gdcmlib/gdcmPrivateTag.h"
#include "gdcmlib/gdcmByteValue.h"
#include "gdcmlib/gdcmSequenceOfItems.h"
using namespace gdcm;
int main(int argc, char *argv[])
{
    if ( argc < 2 ) return 1;
    const char *filename = argv[1];
    gdcm::Reader r;
    r.SetFileName( filename );
    r.Read();
    //gdcm::PrivateTag pt(0x01,0x42,"ELSCINT1");
    //gdcm::Tag pt(0x88,0x200);
    gdcm::Tag pt(0x8,0x1140);
    DataSet &ds = r.GetFile().GetDataSet();
    const DataElement &de = ds.GetDataElement( pt );
    std::cout << de << std::endl;
    const ByteValue *bv = de.GetByteValue();
    SmartPointer<SequenceOfItems> sqi = new SequenceOfItems;
    sqi->SetLength( bv->GetLength() );
    std::stringstream ss;
    ss.str( std::string( bv->GetPointer(), bv->GetLength() ) );
    sqi->Read<ImplicitDataElement,SwapperNoOp>( ss );
    std::cout << *sqi << std::endl;
    return 0;
}

```

## 12.90 ReadGEMSSDO.cxx

```

/*=====
Program: GDCM (Grassroots DICOM). A DICOM library

Copyright (c) 2006-2011 Mathieu Malaterre
All rights reserved.
See Copyright.txt or http://gdcmlib.sourceforge.net/Copyright.html for details.

This software is distributed WITHOUT ANY WARRANTY; without even
the implied warranty of MERCHANTABILITY or FITNESS FOR A PARTICULAR
PURPOSE. See the above copyright notice for more information.

=====*/
#include "gdcmlib/gdcmReader.h"
#include "gdcmlib/gdcmDataElement.h"
#include "gdcmlib/gdcmPrivateTag.h"
#include <iostream>
#include <string>
using namespace gdcm;

```

```

struct SDOElement
{
    typedef std::vector<std::string>::size_type SizeType;
    const char *GetData(SizeType index) const {
        return Data[index].c_str();
    }
    SizeType GetNumberOfData() const {
        return Data.size();
    }
    void SetData(SizeType index, const char *data) {
        Data[index] = data;
    }
    const char *GetDataFormat() const {
        return DataFormat.c_str();
    }
    void SetDataFormat(const char *dataformat, SizeType num) {
        DataFormat = dataformat;
        Data.resize( num );
    }
    void Print( std::ostream &os ) const {
        os << DataFormat << " ";
        std::vector<std::string>::const_iterator it = Data.begin();
        size_t s = 0;
        for( ; it != Data.end(); ++it )
        {
            os << " (" << s++ << ") " << *it << std::endl;
        }
    }
private:
    std::string DataFormat;
    std::vector<std::string> Data;
};

class SDOHeader
{
public:
    typedef std::vector<SDOElement> SDOElements;
    typedef SDOElements::size_type SizeType;
    SizeType GetNumberOfSDOElements() const {
        return InternalSDODataSet.size();
    }
    void AddSDOElement(SDOElement const &sdoelement) {
        InternalSDODataSet.push_back( sdoelement );
    }
    const SDOElement &GetSDOElement(SizeType index) const {
        return InternalSDODataSet[index];
    }
    const SDOElement &GetSDOElementByName(const char *) const {
        return InternalSDODataSet[0];
    }
    void LoadFromAttributes(std::string const &s1, std::string const &s2)
    {
        std::string tok;
        std::string tok2;
        std::stringstream strstr(s1);
        std::stringstream strstr2(s2);
        SDOElement element;
        // Do format
        size_t count = 0;
        while ( std::getline ( strstr2, tok, '\\') )
        {
            //std::cout << tok << " ";
            std::getline ( strstr2, tok2, '\\' );
            //std::cout << tok2 << std::endl;
            count += atoi( tok2.c_str() );
            element.SetDataFormat( tok.c_str(), atoi( tok2.c_str() ) );
            for( size_t t = 0; t < element.GetNumberOfData(); ++t )
            {
                std::getline ( strstr, tok, '\\' );
                element.SetData(t, tok.c_str() );
            }
            AddSDOElement( element );
        }
        //while ( std::getline ( strstr, tok, '^' ) )
        // while ( std::getline ( strstr, tok, '\\' ) )
        // {
        //     std::cout << tok << std::endl;
        //     count++;
        // }
        // std::cout << "Count: " << count << std::endl;
        // count = 0;
        // std::cout << "Count: " << count << std::endl;
    }
};

```

```

    }
    void Print( std::ostream &os ) const {
        SDOElements::const_iterator it = InternalSDODataSet.begin();
        for( ; it != InternalSDODataSet.end(); ++it )
        {
            it->Print ( os );
        }
    }
private:
    SDOElements InternalSDODataSet;
};
bool sdo_decode( DataElement const &stringdata, DataElement const &stringdataformat )
{
    const char *sd = stringdata.GetByteValue()->GetPointer();
    const size_t len_sd = stringdata.GetByteValue()->GetLength();
    std::string s1 = std::string( sd, len_sd );
    const char *sdf = stringdataformat.GetByteValue()->GetPointer();
    const size_t len_sdf = stringdataformat.GetByteValue()->GetLength();
    std::string s2 = std::string( sdf, len_sdf );
    // std::cout << s1 << std::endl;
    // std::cout << s2 << std::endl;
    SDOHeader header;
    header.LoadFromAttributes( s1, s2 );
    header.Print( std::cout );
    return true;
}
int main(int argc, char *argv[])
{
    if( argc < 2 )
    {
        std::cerr << argv[0] << " input.dcm" << std::endl;
        return 1;
    }
    const char *filename = argv[1];
    Reader reader;
    reader.SetFileName( filename );
    if( !reader.Read() )
    {
        return 1;
    }
    File &file = reader.GetFile();
    DataSet &ds = file.GetDataSet();
    // StringData (0033,xx1F) 3 "GEMS_GENIE_1" List of SDO parameters stored as
    // list of strings
    const PrivateTag tstringdata(0x33,0x1f,"GEMS_GENIE_1");
    // StringDataFormat (0033,xx23) 3 "GEMS_GENIE_1" Format of string parameters;
    // contains information about name and number of strings in list
    const PrivateTag tstringdataformat(0x33,0x23,"GEMS_GENIE_1");
    if( !ds.FindDataElement( tstringdata ) ) return 1;
    const DataElement& stringdata = ds.GetDataElement( tstringdata );
    if( !ds.FindDataElement( tstringdataformat ) ) return 1;
    const DataElement& stringdataformat = ds.GetDataElement( tstringdataformat );
    sdo_decode( stringdata, stringdataformat );
    return 0;
}

```

## 12.91 ReadMultiTimesException.cxx

```

/*=====
Program: GDCM (Grassroots DICOM). A DICOM library

Copyright (c) 2006-2011 Mathieu Malaterre
All rights reserved.
See Copyright.txt or http://gdcm.sourceforge.net/Copyright.html for details.

This software is distributed WITHOUT ANY WARRANTY; without even
the implied warranty of MERCHANTABILITY or FITNESS FOR A PARTICULAR
PURPOSE. See the above copyright notice for more information.

=====*/
// The intention of this sample program is to provoke bad_alloc exceptions in gdcm code
#include "gdcmImageReader.h"
int main(int argc, char* argv[])
{
    // We pre-allocate some memory (about 1Gb) to help the issue to show up earlier
    char *dummyBuffer = new char[1024*1024*1100]; (void)dummyBuffer;

```

```

// Check the number of parameters given
if (argc < 3)
{
    std::cerr << "Usage: " << argv[0] << " Filename numberOfTries" << std::endl;
    return 1;
}
std::cout << "We are going to read the file: " << argv[1] << " " << argv[2] << " times" << std::endl;
// We hold the pointers in an array to avoid the memory to be released
// We read the input file n-times
for (int i = 0; i < atoi(argv[2]); ++i)
{
    gdcm::ImageReader reader;
    std::cout << "Reading try: " << i << std::endl;
    // Read files
    reader.SetFileName(argv[1]);
    try
    {
        reader.Read();
        gdcm::Image & img = reader.GetImage();
        unsigned long len = img.GetBufferLength();
        char *buffer = new char[ len ];
        img.GetBuffer( buffer ); // do NOT de-allocate buffer !
    }
    catch (std::bad_alloc &ba)
    {
        (void)ba;
        std::cerr << "BAD ALLOC Exception caught!" << std::endl;
    }
    catch (...)
    {
        std::cerr << "Exception caught!" << std::endl;
    }
}
return 0;
}

```

## 12.92 ReadUTF8QtDir.cxx

```

/*=====
Program: GDCM (Grassroots DICOM). A DICOM library

Copyright (c) 2006-2011 Mathieu Malaterre
All rights reserved.
See Copyright.txt or http://gdcm.sourceforge.net/Copyright.html for details.

This software is distributed WITHOUT ANY WARRANTY; without even
the implied warranty of MERCHANTABILITY or FITNESS FOR A PARTICULAR
PURPOSE. See the above copyright notice for more information.

=====*/
/*
 * GDCM API expect a const char * as input for SetFileName
 * In order to use this API from Qt, here is a simple test that
 * shows how to do it in a portable manner:
 *
 * http://doc.qt.nokia.com/latest/qdir.html#navigation-and-directory-operations
 */
#include "gdcmReader.h"
#include "gdcmDirectory.h"
#include <QDir>
#include <QString>
#include <QCoreApplication>
#include <string>
#include <fstream>
#include <stdio.h> // fopen
static int TestBothFuncs(const char *info , const char *ba_str)
{
    int res = 0;
    FILE *f = fopen( ba_str, "r" );
    if( f )
    {
        std::cout << info << " fopen: " << ba_str << std::endl;
        fclose(f);
        ++res;
    }
    gdcm::Reader reader;
}

```

```

std::ifstream is( ba_str, std::ios::binary );
if( is.is_open() )
{
    std::cout << info << " is_open: " << ba_str << std::endl;
    ++res;
}
reader.SetStream( is );
if( reader.CanRead() == true )
{
    std::cout << info << " SetStream/CanRead:" << ba_str << std::endl;
    ++res;
}
is.close();
reader.SetFileName( ba_str );
if( reader.CanRead() == true )
{
    std::cout << info << " SetFileName/CanRead:" << ba_str << std::endl;
    ++res;
}
return 4 - res;
}
static int scanFolder(const char dirname[])
{
    int res = 0;
    gdcm::Directory dir;
    unsigned int nfiles = dir.Load( dirname, true );
    const gdcm::Directory::FileNamesType &filenames = dir.GetFilesNames();
    for( unsigned int i = 0; i < nfiles; ++i )
    {
        const char *ba_str = filenames[i].c_str();
        res += TestBothFuncs("GDCM",ba_str);
    }
    return res;
}
static int scanFolderQt(QDir const &dir, QStringList& files)
{
    int res = 0;
    QFileInfoList children = dir.entryInfoList(QDir::AllEntries|QDir::NoDotAndDotDot);
    for ( int i=0; i<children.count(); i++ ) {
        QFileInfo file = children.at(i);
        if ( file.isDir() == true ) {
            res += scanFolderQt(QDir(file.absoluteFilePath()), files);
            continue;
        }
        // Convert back from the internal representation to 8bits
        // toLocal8Bit() returns by copy. Need to store explicitly the QByteArray
        QByteArray str = file.absoluteFilePath().toLocal8Bit();
        const char *ba_str1 = str.constData();
        res += TestBothFuncs("QString", ba_str1);
    }
    return res;
}
int main(int argc, char *argv[])
{
    // very important:
    QCoreApplication qCoreApp( argc , argv );
    if( argc < 2 )
    {
        std::cerr << argv[0] << " dir " << std::endl;
        return 1;
    }
    int res = 0;
    const char *dirname = argv[1];
    res += scanFolder( dirname );
    QDir dir( QString::fromLocal8Bit(dirname) );
    QStringList files;
    res += scanFolderQt( dir, files);
    if( res )
        std::cerr << "Problem with UTF-8" << std::endl;
    else
        std::cerr << "Success with UTF-8" << std::endl;
    return res;
}

```

## 12.93 SimpleScanner.cxx

```

/*=====

```

Program: GDCM (Grassroots DICOM). A DICOM library

Copyright (c) 2006-2011 Mathieu Malaterre

All rights reserved.

See Copyright.txt or <http://gdcm.sourceforge.net/Copyright.html> for details.

This software is distributed WITHOUT ANY WARRANTY; without even the implied warranty of MERCHANTABILITY or FITNESS FOR A PARTICULAR PURPOSE. See the above copyright notice for more information.

```

=====*/
/*
 * Simple example to show how to use Scanner API.
 * It exposes the three different cases:
 * - DICOM Attribute is present and has a value
 * - DICOM Attribute is present and has no value
 * - DICOM Attribute is not present at all
 * It also shows the purpose of the function 'IsKey' to detect whether or
 * not the file has been read by the gdcm::Scanner. Technically most of the time
 * if a file is not a 'Key' this is because it is not a DICOM file. You need to use
 * gdcm::System::FileExists to decide whether or not the file actually exist on the disk.
 *
 * It was tested on this particular image:
 * ./SimpleScanner gdcmData/012345.002.050.dcm
 */
#include "gdcmStrictScanner.h"
#include "gdcmSimpleSubjectWatcher.h"
#include "gdcmFileNameEvent.h"
class MyFileWatcher : public gdcm::SimpleSubjectWatcher
{
public:
    MyFileWatcher(gdcm::Subject * s, const char *comment = ""):
        gdcm::SimpleSubjectWatcher(s,comment){}
    void ShowFileName(gdcm::Subject *, const gdcm::Event &evt) override
    {
        const gdcm::FileNameEvent &pe = dynamic_cast<const gdcm::FileNameEvent&>(evt);
        const char *fn = pe.GetFileName();
        std::cout << "FileName: " << fn << " FileSize: " << gdcm::System::FileSize( fn ) << std::endl;
    }
};
int main(int argc, char *argv[])
{
    if( argc < 2 )
    {
        return 1;
    }
    const char *filename = argv[1];
    const char filename_invalid[] = "this is a file that may not exist on this disk.dcm";
    gdcm::SmartPointer<gdcm::StrictScanner> sp = new gdcm::StrictScanner;
    gdcm::StrictScanner &s = *sp;
    //gdcm::SimpleSubjectWatcher w(&s, "TestFileName" );
    MyFileWatcher w(&s, "TestFileName" );
    const gdcm::Tag tag_array[] = {
        gdcm::Tag(0x8,0x50),
        gdcm::Tag(0x8,0x51),
        gdcm::Tag(0x8,0x60),
        gdcm::Tag(0x8,0x80),
    };
    s.AddTag( tag_array[0] );
    s.AddTag( tag_array[1] );
    s.AddTag( tag_array[2] );
    s.AddTag( tag_array[3] );
    gdcm::Directory::FileNamesType filenames;
    filenames.push_back( filename );
    filenames.push_back( filename_invalid );
    if( !s.Scan( filenames ) )
    {
        return 1;
    }
    //s.Print( std::cout );
    for(gdcm::Directory::FileNamesType::const_iterator it = filenames.begin();
        it != filenames.end(); ++it )
    {
        if( s.IsKey( it->c_str() ) )
        {
            std::cout << "INFO:" << it->c_str() << " is a proper Key for the Scanner (this is a DICOM file)" << std::endl;
        }
        else
        {
            std::cout << "INFO:" << it->c_str() << " is not a proper Key for the Scanner (this is either not a DICOM file

```

```

        or file does not exist)" << std::endl;
    }
}
gdcM::StrictScanner::TagToValue const &ttv = s.GetMapping(filename);
const gdcM::Tag *ptag = tag_array;
for( ; ptag != tag_array + 3; ++ptag )
{
    gdcM::StrictScanner::TagToValue::const_iterator it = ttv.find( *ptag );
    if( it != ttv.end() )
    {
        std::cout << *ptag << " was properly found in this file" << std::endl;
        // it contains a pair of value. the first one is the actual tag, so the following is always true:
        // *ptag == it->first
        // The second part is the actual value (stored as RAW strings). You will have to reinterpret this string
        // if VR for *ptag is not VR:VRASCII !
        const char *value = it->second;
        if( *value )
        {
            std::cout << " It has the value: " << value << std::endl;
        }
        else
        {
            std::cout << " It has no value (empty)" << std::endl;
        }
    }
    else
    {
        std::cout << "Sorry " << *ptag << " could not be found in this file" << std::endl;
    }
}
return 0;
}

```

## 12.94 SortImage.cxx

```

/*=====
Program: GDCM (Grassroots DICOM). A DICOM library

Copyright (c) 2006-2011 Mathieu Malaterre
All rights reserved.
See Copyright.txt or http://gdcM.sourceforge.net/Copyright.html for details.

This software is distributed WITHOUT ANY WARRANTY; without even
the implied warranty of MERCHANTABILITY or FITNESS FOR A PARTICULAR
PURPOSE. See the above copyright notice for more information.

=====*/
/*
*/
#include "gdcMSorter.h"
#include "gdcMScanner.h"
#include "gdcMDataSet.h"
#include "gdcMAttribute.h"
bool mysort(gdcM::DataSet const & ds1, gdcM::DataSet const & ds2 )
{
    //gdcM::Attribute<0x0020,0x0013> at1; // Instance Number
    gdcM::Attribute<0x0018,0x1060> at1; // Trigger Time
    gdcM::Attribute<0x0020,0x0032> at11; // Image Position (Patient)
    at1.Set( ds1 );
    at11.Set( ds1 );
    //gdcM::Attribute<0x0020,0x0013> at2;
    gdcM::Attribute<0x0018,0x1060> at2;
    gdcM::Attribute<0x0020,0x0032> at22;
    at2.Set( ds2 );
    at22.Set( ds2 );
    if( at11 == at22 )
    {
        return at1 < at2;
    }
    return at11 < at22;
}
bool mysort_part1(gdcM::DataSet const & ds1, gdcM::DataSet const & ds2 )
{
    gdcM::Attribute<0x0018,0x1060> at1;
    at1.Set( ds1 );
    gdcM::Attribute<0x0018,0x1060> at2;

```

```

    at2.Set( ds2 );
    return at1 < at2;
}
bool mysort_part2(gdcm::DataSet const & ds1, gdcm::DataSet const & ds2 )
{
    gdcm::Attribute<0x0020,0x0032> at1;
    at1.Set( ds1 );
    gdcm::Attribute<0x0020,0x0032> at2;
    at2.Set( ds2 );
    return at1 < at2;
}
// technically all files are in the same Frame of Reference, so this function
// should be a no-op
bool mysort_dummy(gdcm::DataSet const & ds1, gdcm::DataSet const & ds2 )
{
    gdcm::Attribute<0x0020,0x0052> at1; // FrameOfReferenceUID
    at1.Set( ds1 );
    gdcm::Attribute<0x0020,0x0052> at2;
    at2.Set( ds2 );
    return at1 < at2;
}
int main(int argc, char *argv[])
{
    if (argc < 2 ) return 1;
    const char *dirname = argv[1];
    gdcm::Directory dir;
    unsigned int nfiles = dir.Load( dirname );
    dir.Print( std::cout );
    gdcm::Sorter sorter;
    sorter.SetSortFunction( mysort );
    sorter.Sort( dir.GetFilesNames() );
    std::cout << "Sorter:" << std::endl;
    sorter.Print( std::cout );
    gdcm::Sorter sorter2;
    sorter2.SetSortFunction( mysort_part1 );
    sorter2.StableSort( dir.GetFilesNames() );
    sorter2.SetSortFunction( mysort_part2 );
    sorter2.StableSort( sorter2.GetFilesNames() ); // IMPORTANT
    sorter2.SetSortFunction( mysort_dummy );
    sorter2.StableSort( sorter2.GetFilesNames() ); // IMPORTANT
    std::cout << "Sorter2:" << std::endl;
    sorter2.Print( std::cout );
    gdcm::Scanner s;
    s.AddTag( gdcm::Tag(0x20,0x32) ); // Image Position (Patient)
    //s.AddTag( gdcm::Tag(0x20,0x37) ); // Image Orientation (Patient)
    s.Scan( dir.GetFilesNames() );
    //s.Print( std::cout );
    // Count how many different IPP there are:
    const gdcm::Scanner::ValueType &values = s.GetValues();
    size_t nvalues = values.size();
    std::cout << "There are " << nvalues << " different type of values" << std::endl;
    //std::cout << "nfiles=" << nfiles << std::endl;
    if( nfiles % nvalues != 0 )
    {
        std::cerr << "Impossible: this is a not a proper series" << std::endl;
        return 1;
    }
    std::cout << "Series is composed of " << (nfiles/nvalues) << " different 3D volumes" << std::endl;
    return 0;
}

```

## 12.95 StreamImageReaderTest.cxx

```

/*=====
Program: GDICOM (Grassroots DICOM). A DICOM library

Copyright (c) 2006-2011 Mathieu Malaterre
All rights reserved.
See Copyright.txt or http://gdcm.sourceforge.net/Copyright.html for details.

This software is distributed WITHOUT ANY WARRANTY; without even
the implied warranty of MERCHANTABILITY or FITNESS FOR A PARTICULAR
PURPOSE. See the above copyright notice for more information.

=====*/
// This work was realised during the GSOC 2011 by Manoj Alwani

```



```

#include "gdcmStreamImageReader.h"
#include "gdcmFileMetaInformation.h"
#include "gdcmSystem.h"
#include "gdcmFilename.h"
#include "gdcmByteSwap.h"
#include "gdcmTrace.h"
#include "gdcmTesting.h"
#include "gdcmImageHelper.h"
#include "gdcmImageReader.h"
#include "gdcmImage.h"
#include "gdcmMediaStorage.h"
#include "gdcmRAWCodec.h"
#include "gdcmJPEGCodec.h"
#include "gdcmUIDGenerator.h"
#include "gdcmStreamImageWriter.h"
#include "gdcmAttribute.h"
#include "gdcmFile.h"
#include "gdcmTag.h"
bool StreamImageRead(gdcm::StreamImageWriter & theStreamWriter,
    const char* filename, const char* outfileName, int resolution)
{
    gdcm::StreamImageReader reader;
    reader.SetFileName( filename );
    if (!reader.ReadImageInformation())
    {
        std::cerr << "unable to read image information" << std::endl;
        return 1; //unable to read tags as expected.
    }
    //let's be tricky; each image will be read in portions, first the top half, then the bottom
    //that way, we can test how the stream handles fragmentation of the data
    //we could also loop this to get various different size combinations, but I'm not sure
    //that's useful, yet.
    std::vector<unsigned int> extent =
        gdcm::ImageHelper::GetDimensionsValue(reader.GetFile());
    // std::cout << extent[0];
    //at this point, these values aren't used, but may be in the future
    //unsigned short xmin = 0;
    //unsigned short xmax = extent[0];
    //unsigned short ymin = 0;
    //unsigned short ymax = extent[1];
    //unsigned short zmin = 0;
    //unsigned short zmax = extent[2];
    std::cout << "\n Row: " << extent[0] << "\n Col : " << extent[1] << "\n Resolution : " << extent[2] << std::endl;
    int a = 1;
    for (int i=1; i<=(extent[2]-resolution);++i)
        a = a*2;
    reader.DefinePixelExtent(0, extent[0]/a, 0, extent[1]/a, resolution-1, resolution);
    unsigned long len = reader.DefineProperBufferLength();
    char* finalBuffer = new char[len];
    memset(finalBuffer, 0, sizeof(char)*len);
    if (reader.CanReadImage())
    {
        bool result = reader.Read(finalBuffer, len);
        if( !result )
        {
            std::cout << "res2 failure:" << filename << std::endl;
            delete [] finalBuffer;
            return 1;
        }
        else
        {
            std::cout << "Able to read";
        }
    }
    else
    {
        std::cerr << "Not able to put in buffer" << std::endl;
    }
}
/*
//now, read in smaller buffer extents
reader.DefinePixelExtent(xmin, xmax, ymin, ymax);
len = reader.DefineProperBufferLength();

char* buffer = new char[len];
bool res2 = reader.Read(buffer, len);
if( !res2 ){
    std::cerr << "res2 failure:" << filename << std::endl;
    return 1;
}
//copy the result into finalBuffer
memcpy(finalBuffer, buffer, len);

```

```

//now read the next half of the image
ymin = ymax;
ymax = extent[1];

reader.DefinePixelExtent(xmin, xmax, ymin, ymax);

//std::cerr << "Success to read image from file: " << filename << std::endl;
unsigned long len2 = reader.DefineProperBufferLength();

char* buffer2 = new char[len2];
bool res3 = reader.Read(buffer2, len2);
if( !res3 ){
    std::cerr << "res3 failure:" << filename << std::endl;
    return 1;
}
//copy the result into finalBuffer
memcpy(&(finalBuffer[len]), buffer2, len2);

delete [] buffer;
delete [] buffer2;
*/
gdcM::Writer w;
gdcM::File &file = w.GetFile();
gdcM::DataSet &ds = file.GetDataSet();
file.GetHeader().SetDataSetTransferSyntax( gdcM::TransferSyntax::ExplicitVRLittleEndian );
gdcM::UIDGenerator uid;
gdcM::DataElement de( gdcM::Tag(0x8,0x18) ); // SOP Instance UID
de.SetVR( gdcM::VR::UI );
const char *u = uid.Generate();
de.SetByteValue( u, strlen(u) );
ds.Insert( de );
gdcM::DataElement del( gdcM::Tag(0x8,0x16) );
del.SetVR( gdcM::VR::UI );
gdcM::MediaStorage ms( gdcM::MediaStorage::VLWholeSlideMicroscopyImageStorage );
del.SetByteValue( ms.GetString(), strlen(ms.GetString()) );
ds.Insert( del );
const char mystr[] = "MONOCHROME2 ";
gdcM::DataElement de2( gdcM::Tag(0x28,0x04) );
//de.SetTag(gdcM::Tag(0x28,0x04));
de2.SetVR( gdcM::VR::CS );
de2.SetByteValue(mystr, strlen(mystr));
ds.Insert( de2 );
gdcM::Attribute<0x0028,0x0008> Number_Of_Frames = {1};
ds.Insert( Number_Of_Frames.GetAsDataElement() );
gdcM::Attribute<0x0028,0x0010> row = {extent[0]/a};//
ds.Insert( row.GetAsDataElement() );
gdcM::Attribute<0x0028,0x0011> col = {extent[1]/a};//
ds.Insert( col.GetAsDataElement() );
gdcM::Attribute<0x0028,0x0100> at = {8};
ds.Insert( at.GetAsDataElement() );
gdcM::Attribute<0x0028,0x0002> at1 = {1};//
ds.Insert( at1.GetAsDataElement() );
gdcM::Attribute<0x0028,0x0101> at2 = {8};
ds.Insert( at2.GetAsDataElement() );
gdcM::Attribute<0x0028,0x0102> at3 = {7};
ds.Insert( at3.GetAsDataElement() );
/*
ds1.Remove( gdcM::Tag(0x0028,0x0008) );

gdcM::Attribute<0x0028,0x0008> Number_Of_Frames = {1};
ds1.Insert( Number_Of_Frames.GetAsDataElement() );
*/
theStreamWriter.SetFile(file);
if (!theStreamWriter.WriteImageInformation())
{
    std::cerr << "unable to write image information" << std::endl;
    return 1; //the CanWrite function should prevent getting here, else,
    //that's a test failure
}
std::vector<unsigned int> extent1 = gdcM::ImageHelper::GetDimensionsValue(file);
unsigned short xmax = extent1[0];
unsigned short ymax = extent1[1];
unsigned short theChunkSize = 1;
unsigned short ychunk = extent1[1]/theChunkSize; //go in chunk sizes of theChunkSize
unsigned short zmax = 1;
std::cout << "\n Row: " << extent1[0] << "\n Col : " << extent1[1] << "\n Resolution : " << extent1[2] << std::endl;
if (xmax == 0 || ymax == 0)
{
    std::cerr << "Image has no size, unable to write zero-sized image." << std::endl;
    return 0;
}

```

```

    }
    int z, y, nexty;
    unsigned long prevLen = 0; //when going through the char buffer, make sure to grab
    //the bytes sequentially. So, store how far you got in the buffer with each iteration.
    for (z = 0; z < zmax; ++z){
        for (y = 0; y < ymax; y += ychunk){
            nexty = y + ychunk;
            if (nexty > ymax) nexty = ymax;
            theStreamWriter.DefinePixelExtent(0, xmax, y, nexty, z, z+1);
            unsigned long len = theStreamWriter.DefineProperBufferLength();
            std::cout << "\n" << len;
            char* finalBuffer1 = new char[len];
            memcpy(finalBuffer1, &(finalBuffer[prevLen]), len);
            std::cout << "\nable to write";
            if (!theStreamWriter.Write(finalBuffer1, len)){
                std::cerr << "writing failure:" << "output.dcm" << " at y = " << y << " and z = " << z << std::endl;
                delete [] finalBuffer1;
                delete [] finalBuffer;
                return 1;
            }
            delete [] finalBuffer1;
            prevLen += len;
        }
    }
    delete [] finalBuffer;
    std::cout << "all is set";
    return true;
}

int main(int argc, char *argv[])
{
    if( argc < 3 )
    {
        std::cerr << argv[0] << " input.dcm output.dcm Resolution" << std::endl;
        return 1;
    }
    const char *filename = argv[1];
    const char *outfilename = argv[2];
    char *res = argv[3];
    int resolution = atoi(res);
    gdcm::StreamImageWriter theStreamWriter;
    std::ofstream of;
    of.open( outfile, std::ios::out | std::ios::binary );
    theStreamWriter.SetStream(of);
    // else
    // First of get rid of warning/debug message
    gdcm::Trace::DebugOn();
    gdcm::Trace::WarningOn();
    if(!StreamImageRead( theStreamWriter, filename, outfile, resolution))
        return 1;
    uint16_t firstTag1 = 0xffff;
    uint16_t secondTag1 = 0xe0dd;
    uint32_t thirdTag1 = 0x00000000;
    //uint16_t fourthTag1 = 0xffff;
    const int theBufferSizel = 2*sizeof(uint16_t)+sizeof(uint32_t);
    char* tmpBuffer2 = new char[theBufferSizel];
    memcpy(&(tmpBuffer2[0]), &firstTag1, sizeof(uint16_t));
    memcpy(&(tmpBuffer2[sizeof(uint16_t)]), &secondTag1, sizeof(uint16_t));
    memcpy(&(tmpBuffer2[2*sizeof(uint16_t)]), &thirdTag1, sizeof(uint32_t));
    //memcpy(&(tmpBuffer2[3*sizeof(uint16_t)]), &fourthTag1, sizeof(uint16_t));
    assert( of && !of.eof() && of.good() );
    of.write(tmpBuffer2, theBufferSizel);
    of.flush();
    assert( of );
    return 0;
}

```

## 12.96 TemplateEmptyImage.cxx

```

/*=====
Program: GDICOM (Grassroots DICOM). A DICOM library

Copyright (c) 2006-2011 Mathieu Malaterre
All rights reserved.
See Copyright.txt or http://gdcm.sourceforge.net/Copyright.html for details.

This software is distributed WITHOUT ANY WARRANTY; without even

```

the implied warranty of MERCHANTABILITY or FITNESS FOR A PARTICULAR PURPOSE. See the above copyright notice for more information.

```

=====*/
#include "gdcmFileStreamer.h"
#include "gdcmTag.h"
#include "gdcmTrace.h"
#include "gdcmImageRegionReader.h"
#include "gdcmImageHelper.h"
#include "gdcmWriter.h"
#include "gdcmImageWriter.h"
#include "gdcmTagKeywords.h"
#include "gdcmUIDGenerator.h"
int main(int argc, char *argv[])
{
    if( argc < 2 ) return 1;
    const char * filename = argv[1];
    gdcm::ImageRegionReader irr;
    irr.SetFileName( filename );
    const bool b3 = irr.ReadInformation();
    std::cout << b3 << std::endl;
    gdcm::Image & img = irr.GetImage();
    std::cout << img << std::endl;
    // const gdcm::Region & r = irr.GetRegion();
    // std::cout << r << std::endl;
    gdcm::ImageWriter w;
    gdcm::File & file = w.GetFile();
    gdcm::DataSet & ds = file.GetDataSet();
    gdcm::UIDGenerator uid;
    namespace kwd = gdcm::Keywords;
    kwd::FrameOfReferenceUID frameref;
    frameref.SetValue( uid.Generate() );
    // ContentDate
    char date[22];
    const size_t datelen = 8;
    int res = gdcm::System::GetCurrentDateTime( date );
    (void)res;
    kwd::ContentDate contentdate;
    // Do not copy the whole cstring:
    contentdate.SetValue( gdcm::DAComp( date, datelen ) );
    ds.Insert( contentdate.GetAsDataElement() );
    // ContentTime
    const size_t timelen = 6 + 1 + 6; // time + milliseconds
    kwd::ContentTime contenttime;
    // Do not copy the whole cstring:
    contenttime.SetValue( gdcm::TMComp( date+datelen, timelen ) );
    ds.Insert( contenttime.GetAsDataElement() );

    gdcm::MediaStorage ms0 = w.ComputeTargetMediaStorage();
    std::cout << ms0 << std::endl;
    kwd::SeriesNumber seriesnumber = { 1 };
    kwd::InstanceNumber instancenum = { 1 };
    kwd::StudyID studyid = { "St1" };
    kwd::PatientID patientid = { "P1" };
    kwd::SOPClassUID sopclassuid;
    kwd::PositionReferenceIndicator pri;
    //kwd::Laterality lat;
    //kwd::BodyPartExamined bodypartex = { "HEAD" };
    kwd::BodyPartExamined bodypartex = { "ANKLE" };
    kwd::PatientOrientation pator;
    kwd::BurnedInAnnotation bia = { "NO" };
    kwd::ConversionType convtype = { "SYN" };
    kwd::PresentationLUTShape plutshape = { "IDENTITY" }; // MONOCHROME2
    // gdcm will pick the Word in case Byte class is not compatible:
    gdcm::MediaStorage ms = gdcm::MediaStorage::MultiframeGrayscaleByteSecondaryCaptureImageStorage;
    sopclassuid.SetValue( ms.GetString() );
    ds.Insert( instancenum.GetAsDataElement() );
    ds.Insert( sopclassuid.GetAsDataElement() );
    ds.Insert( seriesnumber.GetAsDataElement() );
    ds.Insert( patientid.GetAsDataElement() );
    ds.Insert( studyid.GetAsDataElement() );
    ds.Insert( frameref.GetAsDataElement() );
    ds.Insert( pri.GetAsDataElement() );
    //ds.Insert( lat.GetAsDataElement() );
    ds.Insert( bodypartex.GetAsDataElement() );
    ds.Insert( pator.GetAsDataElement() );
    ds.Insert( bia.GetAsDataElement() );
    ds.Insert( convtype.GetAsDataElement() );
    ds.Insert( plutshape.GetAsDataElement() );
    // gdcm::MediaStorage ms1 = w.ComputeTargetMediaStorage();
    // std::cout << ms1 << std::endl;

```

```

std::cout << ds << std::endl;
gdcM::PixelFormat & pf = img.GetPixelFormat();
pf.SetPixelRepresentation(0); // always overwrite
img.SetSlope(1);
img.SetIntercept(0);
w.SetImage( img );
w.SetFileName( "TemplateImage.dcm" );
if( !w.Write() )
{
    return 1;
}
return 0;
}

```

## 12.97 TraverseModules.cxx

```

/*=====
Program: GDCM (Grassroots DICOM). A DICOM library

Copyright (c) 2006-2011 Mathieu Malaterre
All rights reserved.
See Copyright.txt or http://gdcM.sourceforge.net/Copyright.html for details.

This software is distributed WITHOUT ANY WARRANTY; without even
the implied warranty of MERCHANTABILITY or FITNESS FOR A PARTICULAR
PURPOSE. See the above copyright notice for more information.

=====*/
/*
*/
#include "gdcMDefs.h"
#include "gdcMGlobal.h"
#include "gdcMIODs.h"
#include "gdcMIOD.h"
#include "gdcMMacros.h"
#include "gdcMIODEntry.h"
#include "gdcMModules.h"
#include "gdcModule.h"
#include "gdcMAnonymizer.h"
#include "gdcMDicts.h"
int main(int , char *[])
{
    using namespace gdcM;
    static Global &g = Global::GetInstance();
    if( !g.LoadResourcesFiles() )
    {
        return 1;
    }
    static const Defs &defs = g.GetDefs();
    static const Modules &modules = defs.GetModules();
    static const IODs &iods = defs.GetIODs();
    static const Macros &macros = defs.GetMacros();
    static const Dicts &dicts = g.GetDicts();
    std::vector<Tag> tags = gdcM::Anonymizer::GetBasicApplicationLevelConfidentialityProfileAttributes();
    for( std::vector<Tag>::const_iterator tit = tags.begin(); tit != tags.end(); ++tit )
    {
        const Tag &tag = *tit;
        const DictEntry &dictentry = dicts.GetDictEntry(tag);
        std::cout << "Processing Attribute: " << tag << " " << dictentry << std::endl;
        IODs::IODMapTypeConstIterator it = iods.Begin();
        for( ; it != iods.End(); ++it )
        {
            const IODs::IODName &name = it->first;
            const IOD &iod = it->second;
            const size_t niods = iod.GetNumberOfIODs();
            // Iterate over each iod entry in order:
            for(unsigned int idx = 0; idx < niods; ++idx)
            {
                const IODEntry &iodentry = iod.GetIODEntry(idx);
                const char *ref = iodentry.GetRef();
                //Usage::UsageType ut = iodentry.GetUsageType();
                const Module &module = modules.GetModule( ref );
                if( module.FindModuleEntryInMacros(macros, tag) )
                {
                    const ModuleEntry &module_entry = module.GetModuleEntryInMacros(macros,tag);

```

```

        Type type = module_entry.GetType();
        std::cout << "IOD Name: " << name << std::endl;
        std::cout << "Type: " << type << std::endl;
    }
}
}
return 0;
}

```

## 12.98 VolumeSorter.cxx

```

/*=====
Program: GDCM (Grassroots DICOM). A DICOM library

Copyright (c) 2006-2011 Mathieu Malaterre
All rights reserved.
See Copyright.txt or http://gdcm.sourceforge.net/Copyright.html for details.

This software is distributed WITHOUT ANY WARRANTY; without even
the implied warranty of MERCHANTABILITY or FITNESS FOR A PARTICULAR
PURPOSE. See the above copyright notice for more information.

=====*/
*/
#include "gdcmSorter.h"
#include "gdcmIPPSorter.h"
#include "gdcmScanner.h"
#include "gdcmDataSet.h"
#include "gdcmAttribute.h"
#include "gdcmTesting.h"
bool mysort1(gdcm::DataSet const & ds1, gdcm::DataSet const & ds2 )
{
    gdcm::Attribute<0x0020,0x000d> at1;
    at1.Set( ds1 );
    gdcm::Attribute<0x0020,0x000d> at2;
    at2.Set( ds2 );
    return at1 < at2;
}
bool mysort2(gdcm::DataSet const & ds1, gdcm::DataSet const & ds2 )
{
    gdcm::Attribute<0x0020,0x000e> at1;
    at1.Set( ds1 );
    gdcm::Attribute<0x0020,0x000e> at2;
    at2.Set( ds2 );
    return at1 < at2;
}
bool mysort3(gdcm::DataSet const & ds1, gdcm::DataSet const & ds2 )
{
    // This is a floating point number is the comparison ok ?
    gdcm::Attribute<0x0020,0x0037> at1;
    at1.Set( ds1 );
    gdcm::Attribute<0x0020,0x0037> at2;
    at2.Set( ds2 );
    return at1 < at2;
}
bool mysort4(gdcm::DataSet const & ds1, gdcm::DataSet const & ds2 )
{
    // Do the IPP sorting here
    gdcm::Attribute<0x0020,0x0032> iop1;
    gdcm::Attribute<0x0020,0x0037> iop1;
    iop1.Set( ds1 );
    iop1.Set( ds1 );
    gdcm::Attribute<0x0020,0x0032> iop2;
    gdcm::Attribute<0x0020,0x0037> iop2;
    iop2.Set( ds2 );
    iop2.Set( ds2 );
    if( iop1 != iop2 )
    {
        return false;
    }
    // else
    double normal[3];
    normal[0] = iop1[1]*iop1[5] - iop1[2]*iop1[4];
    normal[1] = iop1[2]*iop1[3] - iop1[0]*iop1[5];
}

```

```

normal[2] = iopl[0]*iopl[4] - iopl[1]*iopl[3];
double dist1 = 0;
for (int i = 0; i < 3; ++i) dist1 += normal[i]*iopl[i];
double dist2 = 0;
for (int i = 0; i < 3; ++i) dist2 += normal[i]*iopl[i];
std::cout << dist1 << ", " << dist2 << std::endl;
return dist1 < dist2;
}
int main(int argc, char *argv[])
{
    const char *extradataroot = gdcm::Testing::GetDataExtraRoot();
    std::string dir1;
    if( argc < 2 )
    {
        if( !extradataroot )
        {
            return 1;
        }
        dir1 = extradataroot;
        dir1 += "/gdcmSampleData/ForSeriesTesting/VariousIncidences/ST1";
    }
    else
    {
        dir1 = argv[1];
    }
    gdcm::Directory d;
    d.Load( dir1.c_str(), true ); // recursive !
    const gdcm::Directory::FileNamesType &l1 = d.GetFilesNames();
    const size_t nfiles = l1.size();
    std::cout << nfiles << std::endl;
    //if( nfiles != 280 )
    // {
    //     return 1;
    // }
    //d.Print( std::cout );
    gdcm::Scanner s0;
    const gdcm::Tag t1(0x0020,0x000d); // Study Instance UID
    const gdcm::Tag t2(0x0020,0x000e); // Series Instance UID
    //const gdcm::Tag t3(0x0010,0x0010); // Patient's Name
    s0.AddTag( t1 );
    s0.AddTag( t2 );
    //s0.AddTag( t3 );
    //s0.AddTag( t4 );
    //s0.AddTag( t5 );
    //s0.AddTag( t6 );
    bool b = s0.Scan( d.GetFilesNames() );
    if( !b )
    {
        std::cerr << "Scanner failed" << std::endl;
        return 1;
    }
    //s0.Print( std::cout );
    // Only get the DICOM files:
    gdcm::Directory::FileNamesType l2 = s0.GetKeys();
    const size_t nfiles2 = l2.size();
    std::cout << nfiles2 << std::endl;
    if ( nfiles2 > nfiles )
    {
        return 1;
    }
    gdcm::Sorter sorter;
    sorter.SetSortFunction( mysort1 );
    sorter.StableSort( l2 );
    sorter.SetSortFunction( mysort2 );
    sorter.StableSort( sorter.GetFilesNames() );
    sorter.SetSortFunction( mysort3 );
    sorter.StableSort( sorter.GetFilesNames() );
    sorter.SetSortFunction( mysort4 );
    sorter.StableSort( sorter.GetFilesNames() );
    //sorter.Print( std::cout );
    // Let's try to check our result:
    // assume that IPP is precise enough so that we can test floating point equality:
    size_t nvalues = 0;
{
    gdcm::Scanner s;
    s.AddTag( gdcm::Tag(0x20,0x32) ); // Image Position (Patient)
    //s.AddTag( gdcm::Tag(0x20,0x37) ); // Image Orientation (Patient)
    s.Scan( d.GetFilesNames() );
    //s.Print( std::cout );
    const gdcm::Scanner::ValuesType &values = s.GetValues();
    nvalues = values.size();
}

```

```

std::cout << "There are " << nvalues << " different type of values" << std::endl;
assert( nfiles2 % nvalues == 0 );
std::cout << "Series is composed of " << (nfiles/nvalues) << " different 3D volumes" << std::endl;
}
gdcmm::Directory::FileNamesType sorted_files = sorter.GetFilesNames();
// Which means we can take nvalues files at a time and execute gdcmm::IPPSorter on it:
gdcmm::IPPSorter ippsorter;
gdcmm::Directory::FileNamesType sub( sorted_files.begin(), sorted_files.begin() + nvalues);
std::cout << sub.size() << std::endl;
std::cout << sub[0] << std::endl;
std::cout << sub[nvalues-1] << std::endl;
ippsorter.SetComputeZSpacing( false );
if( !ippsorter.Sort( sub ) )
{
    std::cerr << "Could not sort" << std::endl;
    return 1;
}
std::cout << "IPPSorter:" << std::endl;
ippsorter.Print( std::cout );
return 0;
}

```

## 12.99 csa2img.cxx

```

/*=====
Program: GDCM (Grassroots DICOM). A DICOM library

Copyright (c) 2006-2011 Mathieu Malaterre
All rights reserved.
See Copyright.txt or http://gdcmm.sourceforge.net/Copyright.html for details.

This software is distributed WITHOUT ANY WARRANTY; without even
the implied warranty of MERCHANTABILITY or FITNESS FOR A PARTICULAR
PURPOSE. See the above copyright notice for more information.
=====*/
/*
* I do not know what the format is, just guessing from info found on the net:
*
* http://atonal.ucdavis.edu/matlab/fmri/spm5/spm_dicom_convert.m
*
* This example is an attempt at understanding the format used by SIEMENS
* their "SIEMENS CSA NON-IMAGE" DICOM file (1.3.12.2.1107.5.9.1)
*
* Everything done in this code is for the sole purpose of writing interoperable
* software under Sect. 1201 (f) Reverse Engineering exception of the DMCA.
* If you believe anything in this code violates any law or any of your rights,
* please contact us (gdcmm-developers@lists.sourceforge.net) so that we can
* find a solution.
*/
#include "gdcmmReader.h"
#include "gdcmmImageReader.h"
#include "gdcmmImageWriter.h"
#include "gdcmmCSAHeader.h"
#include "gdcmmAttribute.h"
#include "gdcmmPrivateTag.h"
#include <math.h>
int main(int argc, char *argv [])
{
    if( argc < 2 ) return 1;
    // gdcmmDataExtra/gdcmmNonImageData/exCSA_Non-Image_Storage.dcm
    // PHANTOM.MR.CARDIO_COEUR_S_QUENCE_DE_REP_RAGE.9.257.2008.03.20.14.53.25.578125.43151705.IMA
    const char *filename = argv[1];
    gdcmm::Reader reader; // Do not use ImageReader
    reader.SetFileName( filename );
    if( !reader.Read() )
    {
        std::cerr << "Failed to read: " << filename << std::endl;
        return 1;
    }
    gdcmm::CSAHeader csa;
    const gdcmm::DataSet& ds = reader.GetFile().GetDataSet();
    const gdcmm::PrivateTag &t1 = csa.GetCSAImageHeaderInfoTag();
    //std::cout << t1 << std::endl;
    //const gdcmm::PrivateTag &t2 = csa.GetCSASeriesHeaderInfoTag();

```



```

if( ds.FindDataElement( t1 ) )
{
    csa.LoadFromDataElement( ds.GetDataElement( t1 ) );
    csa.Print( std::cout );
}
int dims[2] = {};
if( csa.FindCSAElementByName( "Columns" ) )
{
    const gdcm::CSAElement &csael = csa.GetCSAElementByName( "Columns" );
    std::cout << csael << std::endl;
    //const gdcm::ByteValue *bv = csael.GetByteValue();
    gdcm::Element<gdcm::VR::IS, gdcm::VM::VM1> el;
    el.Set( csael.GetValue() );
    dims[0] = el.GetValue();
    std::cout << "Columns:" << el.GetValue() << std::endl;
}
if( csa.FindCSAElementByName( "Rows" ) )
{
    const gdcm::CSAElement &csael2 = csa.GetCSAElementByName( "Rows" );
    std::cout << csael2 << std::endl;
    gdcm::Element<gdcm::VR::IS, gdcm::VM::VM1> el2;
    el2.Set( csael2.GetValue() );
    dims[1] = el2.GetValue();
    std::cout << "Rows:" << el2.GetValue() << std::endl;
}
double spacing[2] = { 1., 1. };
bool spacingfound = false;
if( csa.FindCSAElementByName( "PixelSpacing" ) )
{
    const gdcm::CSAElement &csael3 = csa.GetCSAElementByName( "PixelSpacing" );
    if( !csael3.IsEmpty() )
    {
        std::cout << csael3 << std::endl;
        gdcm::Element<gdcm::VR::DS, gdcm::VM::VM2> el3;
        el3.Set( csael3.GetValue() );
        spacing[0] = el3.GetValue(0);
        spacing[1] = el3.GetValue(1);
        std::cout << "PixelSpacing:" << el3.GetValue() << "," << el3.GetValue(1) << std::endl;
        spacingfound = true;
    }
}
if( !spacingfound )
{
    std::cerr << "Problem with PixelSpacing" << std::endl;
    //return 1;
}
if( !dims[0] || !dims[1] )
{
    std::cerr << "Problem with dims" << std::endl;
    return 1;
}
gdcm::ImageWriter writer;
gdcm::Image &image = writer.GetImage();
image.SetNumberOfDimensions( 2 ); // good default
image.SetDimension(0, dims[0] );
image.SetDimension(1, dims[1] );
image.SetSpacing(0, spacing[0] );
image.SetSpacing(1, spacing[1] );
gdcm::PixelFormat pixeltype = gdcm::PixelFormat::INT16; // bytewidth = spm_type('int16','bits')/8;
//unsigned long l = image.GetBufferLength();
//const int p = 1 / (dims[0] * dims[1]);
//image.SetNumberOfDimensions( 3 );
//image.SetDimension(2, p / pixeltype.GetPixelSize() );
gdcm::PhotometricInterpretation pi;
pi = gdcm::PhotometricInterpretation::MONOCHROME2;
//pixeltype.SetSamplesPerPixel( );
image.SetPhotometricInterpretation( pi );
image.SetPixelFormat( pixeltype );
//image.SetIntercept( inputimage.GetIntercept() );
//image.SetSlope( inputimage.GetSlope() );
//gdcm::DataElement pixeldata( gdcm::Tag(0x7fe1,0x1010) );
//pixeldata.SetByteValue( &outbuf[0], outbuf.size() );
gdcm::PrivateTag csanonimaget(0x7fe1,0x10,"SIEMENS CSA NON-IMAGE");
const gdcm::DataElement &pixeldata = ds.GetDataElement( csanonimaget );
image.SetDataElement( pixeldata );
std::string outfilename = "outcsa.dcm";
//writer.SetFile( reader.GetFile() );
writer.SetFileName( outfilename.c_str() );
if( !writer.Write() )
{
    std::cerr << "could not write: " << outfilename << std::endl;
}

```

```

    return 1;
}
return 0;
}

```

## 12.100 iU22tomultisc.cxx

```

/*=====
Program: GDCM (Grassroots DICOM). A DICOM library

Copyright (c) 2006-2011 Mathieu Malaterre
All rights reserved.
See Copyright.txt or http://gdcml.sourceforge.net/Copyright.html for details.

This software is distributed WITHOUT ANY WARRANTY; without even
the implied warranty of MERCHANTABILITY or FITNESS FOR A PARTICULAR
PURPOSE. See the above copyright notice for more information.
=====*/

/*
 * iU22 Raw Data extractor
 */
#include "gdcmlReader.h"
#include "gdcmlImageWriter.h"
#include "gdcmlAttribute.h"
#include "gdcmlPrivateTag.h"
#include <math.h>
int main(int argc, char *argv [])
{
    if( argc < 2 ) return 1;
    // IM_001
    const char *filename = argv[1];
    gdcml::Reader reader; // Do not use ImageReader
    reader.SetFileName( filename );
    if( !reader.Read() )
    {
        std::cerr << "Failed to read: " << filename << std::endl;
        return 1;
    }
    // * The data is simply 8-bit unsigned in the obvious x/y/z order
    // * 200D,300B contains the data
    // * 200D,3001 contains the no. of voxels (416,412,256 in this case)
    // * 200D,3003 contains the voxel sizes (0.156184527398215 /
    // 0.1223749613981957 / 0.328479990704639 in this case)
    const gdcml::File &file = reader.GetFile();
    const gdcml::DataSet &ds = file.GetDataSet();
    const gdcml::PrivateTag trawdataus( 0x200d, 0x0b, "Philips US Imaging DD 033" );
    const gdcml::DataElement &rawdataus = ds.GetDataElement( trawdataus );
    const gdcml::PrivateTag tcolsrowsframes( 0x200d, 0x01, "Philips US Imaging DD 036" );
    const gdcml::DataElement &colsrowsframes = ds.GetDataElement( tcolsrowsframes );
    // const gdcml::PrivateTag tcolsrowsframes( 0x200d, 0x02, "Philips US Imaging DD 036" );
    // this is just a duplicate previous tag.
    const gdcml::PrivateTag tvoxelspacing( 0x200d, 0x03, "Philips US Imaging DD 036" );
    const gdcml::DataElement &voxelspacing = ds.GetDataElement( tvoxelspacing );
    gdcml::Element<gdcml::VR::DS,gdcml::VM::VM3> dims; // Use DS to interpret value stored in LO
    dims.SetFromDataElement( colsrowsframes );
    gdcml::Element<gdcml::VR::DS,gdcml::VM::VM3> spacing;
    spacing.SetFromDataElement( voxelspacing );
    gdcml::ImageWriter writer;
    gdcml::Image &image = writer.GetImage();
    image.SetNumberOfDimensions( 3 ); // good default
    image.SetDimension(0, (unsigned int)dims[0] );
    image.SetDimension(1, (unsigned int)dims[1] );
    image.SetDimension(2, (unsigned int)dims[2] );
    image.SetSpacing(0, spacing[0] );
    image.SetSpacing(1, spacing[1] );
    image.SetSpacing(2, spacing[2] );
    gdcml::PixelFormat pixeltype = gdcml::PixelFormat::UINT8;
    gdcml::PhotometricInterpretation pi;
    pi = gdcml::PhotometricInterpretation::MONOCHROME2;
    image.SetPhotometricInterpretation( pi );
    image.SetPixelFormat( pixeltype );
    image.SetDataElement( rawdataus );
    std::string outfile = "outiu22.dcm";
    gdcml::DataElement de( gdcml::Tag(0x8,0x16) ); // SOP Class UID
    de.SetVR( gdcml::VR::UI );

```

```

gdcM::MediaStorage ms(
    gdcM::MediaStorage::UltrasoundMultiFrameImageStorage );
// gdcM::MediaStorage::MultiFrameGrayscaleByteSecondaryCaptureImageStorage );
de.SetByteValue( ms.GetString(), (uint32_t)strlen(ms.GetString()));
writer.GetFile().GetDataSet().Replace( de );
writer.SetFileName( outfilename.c_str() );
if( !writer.Write() )
{
    std::cerr << "could not write: " << outfilename << std::endl;
    return 1;
}
return 0;
}

```

## 12.101 pmsct\_rgb1.cxx

```

/*=====
Program: GDCM (Grassroots DICOM). A DICOM library

Copyright (c) 2006-2011 Mathieu Malaterre
All rights reserved.
See Copyright.txt or http://gdcM.sourceforge.net/Copyright.html for details.

This software is distributed WITHOUT ANY WARRANTY; without even
the implied warranty of MERCHANTABILITY or FITNESS FOR A PARTICULAR
PURPOSE. See the above copyright notice for more information.
=====*/
/*
* This example shows how to rewrite a ELSCINT1/PMSCT_RGB1 compressed
* image so that it is readable by most 3rd party software (DICOM does
* not specify this particular encoding).
* This is required for the sake of interoperability with any standard
* conforming DICOM system.
*
* Everything done in this code is for the sole purpose of writing interoperable
* software under Sect. 1201 (f) Reverse Engineering exception of the DMCA.
* If you believe anything in this code violates any law or any of your rights,
* please contact us (gdcM-developers@lists.sourceforge.net) so that we can
* find a solution.
*
* Everything you do with this code is at your own risk, since decompression
* algorithm was not written from specification documents.
*
* Special thanks to:
* Jean-Pierre Roux for providing the sample datasets
*/
#include "gdcMReader.h"
#include "gdcMPrivateTag.h"
#include "gdcMAttribute.h"
#include "gdcMImageWriter.h"
void delta_decode(const unsigned char *data_in, size_t data_size,
    std::vector<unsigned char> &new_stream, unsigned short pc, size_t w, size_t h)
{
    const size_t plane_size = h * w;
    const size_t outputlen = 3 * plane_size;
    new_stream.resize( outputlen );
    assert( data_size != outputlen );
    if( data_size == outputlen )
    {
        return;
    }
    typedef unsigned char byte;
    enum {
        COLORMODE = 0x81,
        ESCMODE = 0x82,
        REPEATMODE = 0x83
    };
    const byte* src = (const byte*)data_in;
    byte* dest = (byte*)&new_stream[0];
    union { byte gray; byte rgb[3]; } pixel;
    pixel.rgb[0] = pixel.rgb[1] = pixel.rgb[2] = 0;
    // always start in grayscale mode
    bool graymode = true;
    size_t dx = 1;
    size_t dy = 3;
}

```

```

// algorithm works with both planar configuration
// It does produce surprising greenish background color for planar
// configuration is 0, while the nested Icon SQ display a nice black
// background
if (pc)
{
    dx = plane_size;
    dy = 1;
}
size_t ps = plane_size;
// The following is highly unoptimized as we have nested if statement in a while loop
// we need to switch from one algorithm to ther other (RGB <-> GRAY)
while (ps)
{
    // next byte:
    byte b = *src++;
    assert( src < data_in + data_size );
    // mode selection:
    switch ( b )
    {
    case ESCMODE:
        // Used to treat a byte 81/82/83 as a normal byte
        if (graymode)
        {
            pixel.gray += *src++;
            dest[0*dx] = pixel.gray;
            dest[1*dx] = pixel.gray;
            dest[2*dx] = pixel.gray;
        }
        else
        {
            pixel.rgb[0] += *src++;
            pixel.rgb[1] += *src++;
            pixel.rgb[2] += *src++;
            dest[0*dx] = pixel.rgb[0];
            dest[1*dx] = pixel.rgb[1];
            dest[2*dx] = pixel.rgb[2];
        }
        dest += dy;
        ps--;
        break;
    case REPEATMODE:
        // repeat mode (RLE)
        b = *src++;
        ps -= b;
        if (graymode)
        {
            while (b-- > 0)
            {
                dest[0*dx] = pixel.gray;
                dest[1*dx] = pixel.gray;
                dest[2*dx] = pixel.gray;
                dest += dy;
            }
        }
        else
        {
            while (b-- > 0)
            {
                dest[0*dx] = pixel.rgb[0];
                dest[1*dx] = pixel.rgb[1];
                dest[2*dx] = pixel.rgb[2];
                dest += dy;
            }
        }
        break;
    case COLORMODE:
        // We are swithing from one mode to the other. The stream contains an intermixed
        // compression of RGB codec and GRAY codec. Each one not knowing of the other
        // reset old value to 0.
        if (graymode)
        {
            graymode = false;
            pixel.rgb[0] = pixel.rgb[1] = pixel.rgb[2] = 0;
        }
        else
        {
            graymode = true;
            pixel.gray = 0;
        }
        break;
    }
}

```

```

default:
    // This is identical to ESCMODE, it would be nicer to use fall-through
    if (graymode)
    {
        pixel.gray += b;
        dest[0*dx] = pixel.gray;
        dest[1*dx] = pixel.gray;
        dest[2*dx] = pixel.gray;
    }
    else
    {
        pixel.rgb[0] += b;
        pixel.rgb[1] += *src++;
        pixel.rgb[2] += *src++;
        dest[0*dx] = pixel.rgb[0];
        dest[1*dx] = pixel.rgb[1];
        dest[2*dx] = pixel.rgb[2];
    }
    dest += dy;
    ps--;
    break;
} // end switch
} // end while
}
int main(int argc, char *argv [])
{
    if( argc < 2 ) return 1;
    const char *filename = argv[1];
    gdcm::Reader reader;
    reader.SetFileName( filename );
    if( !reader.Read() )
    {
        std::cerr << "Failed to read: " << filename << std::endl;
        return 1;
    }
    const gdcm::DataSet& ds = reader.GetFile().GetDataSet();
    // (07a1,1011) CS [PMSCT_RGB1] # 10,1 Tamar Compression Type
    const gdcm::PrivateTag tcompressiontype(0x07a1,0x0011,"ELSCINT1");
    if( !ds.FindDataElement( tcompressiontype ) ) return 1;
    const gdcm::DataElement& compressiontype = ds.GetDataElement( tcompressiontype );
    if ( compressiontype.IsEmpty() ) return 1;
    const gdcm::ByteValue * bv = compressiontype.GetByteValue();
    std::string comprle = "PMSCT_RLE1";
    std::string comprgb = "PMSCT_RGB1";
    bool isrle = false;
    bool isrgb = false;
    if( strcmp( bv->GetPointer(), comprle.c_str(), comprle.size() ) == 0 )
    {
        isrle = true;
        return 1;
    }
    if( strcmp( bv->GetPointer(), comprgb.c_str(), comprgb.size() ) == 0 )
    {
        isrgb = true;
    }
    if( !isrgb && !isrle ) return 1;
    const gdcm::PrivateTag tcompressedpixeldata(0x07a1,0x000a,"ELSCINT1");
    if( !ds.FindDataElement( tcompressedpixeldata ) ) return 1;
    const gdcm::DataElement& compressionpixeldata = ds.GetDataElement( tcompressedpixeldata );
    if ( compressionpixeldata.IsEmpty() ) return 1;
    const gdcm::ByteValue * bv2 = compressionpixeldata.GetByteValue();
    gdcm::Attribute<0x0028,0x0006> at0;
    at0.SetFromDataSet( ds );
    gdcm::Attribute<0x0028,0x0010> at1;
    at1.SetFromDataSet( ds );
    gdcm::Attribute<0x0028,0x0011> at2;
    at2.SetFromDataSet( ds );
    std::vector<unsigned char> buffer;
    delta_decode((const unsigned char*)bv2->GetPointer(), bv2->GetLength(), buffer,
        at0.GetValue(), at1.GetValue(), at2.GetValue() );
    gdcm::DataElement pixeldata( gdcm::Tag(0x7fe0,0x0010) );
    pixeldata.SetVR( gdcm::VR::OW );
    pixeldata.SetByteValue( (char*)&buffer[0], (uint32_t)buffer.size() );
    // TODO we should check that decompress byte buffer match the expected size (row*col*...)
    // Add the pixel data element
    reader.GetFile().GetDataSet().Replace( pixeldata );
    reader.GetFile().GetHeader().SetDataSetTransferSyntax(
        gdcm::TransferSyntax::ExplicitVRLittleEndian);
    gdcm::Writer writer;
    writer.SetFile( reader.GetFile() );
    // Cleanup stuff:

```

```

// remove the compressed pixel data:
// FIXME: should I remove more private tags ? all of them ?
// oh well this is just an example
// use gdcm::Anonymizer::RemovePrivateTags if needed...
writer.GetFile().GetDataSet().Remove( compressionpixeldata.GetTag() );
std::string outfilename;
if (argc > 2)
    outfilename = argv[2];
else
    outfilename = "outrgb.dcm";
writer.SetFileName( outfilename.c_str() );
if( !writer.Write() )
{
    std::cerr << "Failed to write" << std::endl;
    return 1;
}
std::cout << "success !" << std::endl;
return 0;
}

```

## 12.102 rle2img.cxx

```

/*=====
Program: GDCM (Grassroots DICOM). A DICOM library

Copyright (c) 2006-2011 Mathieu Malaterre
All rights reserved.
See Copyright.txt or http://gdcm.sourceforge.net/Copyright.html for details.

This software is distributed WITHOUT ANY WARRANTY; without even
the implied warranty of MERCHANTABILITY or FITNESS FOR A PARTICULAR
PURPOSE. See the above copyright notice for more information.

=====*/
/*
* This example shows how to rewrite a ELSCINT1/PMSCT_RLE1 compressed
* image so that it is readable by most 3rd party software (DICOM does
* not specify this particular encoding).
* This is required for the sake of interoperability with any standard
* conforming DICOM system.
*
* Everything done in this code is for the sole purpose of writing interoperable
* software under Sect. 1201 (f) Reverse Engineering exception of the DMCA.
* If you believe anything in this code violates any law or any of your rights,
* please contact us (gdcm-developers@lists.sourceforge.net) so that we can
* find a solution.
*
* Everything you do with this code is at your own risk, since decompression
* algorithm was not written from specification documents.
*
* Special thanks to:
* Mauro Maiorca for bringing to our attention on this new ELSCINT1
* compression algorithm : PMSCT_RLE1 (different from the 'LOSSLESS RICE')
* See post at:
* http://groups.google.com/group/comp.protocols.dicom/msg/f2b99bf706a7f8ca
*
* Thanks to Jesus Spinola, for more datasets,
* http://www.itk.org/pipermail/insight-users/2008-April/025571.html
*
* And last but not least, a very big thank to Ivo van Poorten, without
* whom we would still be looking at this compressed byte stream as if
* it was RLE compressed.
*/
#include "gdcmReader.h"
#include "gdcmPrivateTag.h"
#include "gdcmAttribute.h"
#include "gdcmImageWriter.h"
/* FIXME: Why is PhilipsLosslessRice.dcm a 512x512 image ... */
void delta_decode(const char *inbuffer, size_t length, std::vector<unsigned short> &output)
{
    // RLE pass
    std::vector<char> temp;
    for(size_t i = 0; i < length; ++i)
    {
        if( inbuffer[i] == (char)0xa5 )
        {

```

```

    //unsigned char repeat = (unsigned char)inbuffer[i+1] + 1;
    //assert( (unsigned char)inbuffer[i+1] != 255 );
    int repeat = (unsigned char)inbuffer[i+1] + 1;
    char value = inbuffer[i+2];
    while(repeat)
    {
        temp.push_back( value );
        --repeat;
    }
    i+=2;
}
else
{
    temp.push_back( inbuffer[i] );
}
}
// Delta encoding pass
unsigned short delta = 0;
for(size_t i = 0; i < temp.size(); ++i)
{
    if( temp[i] == 0x5a )
    {
        unsigned char v1 = (unsigned char)temp[i+1];
        unsigned char v2 = (unsigned char)temp[i+2];
        unsigned short value = (unsigned short)(v2 * 256 + v1);
        output.push_back( value );
        delta = value;
        i+=2;
    }
    else
    {
        unsigned short value = (unsigned short)(temp[i] + delta);
        output.push_back( value );
        delta = value;
    }
    //assert( output[output.size()-1] == ref[output.size()-1] );
}
if ( output.size() % 2 )
{
    output.resize( output.size() - 1 );
}
std::cout << length << " -> " << output.size() * 2 << std::endl;
}
int main(int argc, char *argv [])
{
    if( argc < 2 )
    {
        std::cerr << argv[0] << "input.dcm [output.dcm]" << std::endl;
        std::cerr << "will default to 'outrle.dcm' unless output.dcm is specified."
        << std::endl;
        return 1;
    }
    const char *filename = argv[1];
    gdcm::Reader reader;
    reader.SetFileName( filename );
    if( !reader.Read() )
    {
        std::cerr << "Failed to read: " << filename << std::endl;
        return 1;
    }
    const gdcm::DataSet& ds = reader.GetFile().GetDataSet();
    // (07a1,1011) CS [PMSCT_RLE1] # 10,1 Tamar Compression Type
    const gdcm::PrivateTag tcompressiontype(0x07a1,0x0011,"ELSCINT1");
    if( !ds.FindDataElement( tcompressiontype ) ) return 1;
    const gdcm::DataElement& compressiontype = ds.GetDataElement( tcompressiontype );
    if ( compressiontype.IsEmpty() ) return 1;
    const gdcm::ByteValue * bv = compressiontype.GetByteValue();
    std::string comprle = "PMSCT_RLE1";
    std::string comprgb = "PMSCT_RGB1";
    bool isrle = false;
    bool isrgb = false;
    if( strcmp( bv->GetPointer(), comprle.c_str(), comprle.size() ) == 0 )
    {
        isrle = true;
    }
    if( strcmp( bv->GetPointer(), comprgb.c_str(), comprgb.size() ) == 0 )
    {
        isrgb = true;
        std::cerr << "See: pmsct_rgb1.cxx instead" << std::endl;
        return 1;
    }
}

```

```

if( !isrgb && !isrle ) return 1;
// check if compressed pixel data reside in private or standard tag
const gdcm::PrivateTag tprivatepixeldata(0x07a1,0x100a,"ELSCINT1");
const gdcm::Tag tstandardpixeldata(0x7fe0, 0x0010);
gdcm::Tag tpixeldata;
if(ds.FindDataElement(tprivatepixeldata)) tpixeldata = tprivatepixeldata;
else if(ds.FindDataElement(tstandardpixeldata)) tpixeldata = tstandardpixeldata;
if(!ds.FindDataElement(tpixeldata)) return 1;
const gdcm::DataElement& compressionpixeldata = ds.GetDataElement( tpixeldata);
if ( compressionpixeldata.IsEmpty() ) return 1;
const gdcm::ByteValue * bv2 = compressionpixeldata.GetByteValue();
gdcm::Attribute<0x0028,0x0010> at1;
at1.SetFromDataSet( ds );
gdcm::Attribute<0x0028,0x0011> at2;
at2.SetFromDataSet( ds );
gdcm::DataElement pixeldata;
// if standard voxel data element does not exist, create it
if( !reader.GetFile().GetDataSet().FindDataElement( tpixeldata ) )
{
    pixeldata = gdcm::DataElement( tpixeldata, 0, gdcm::VR::OW );
}
else{
    pixeldata = reader.GetFile().GetDataSet().GetDataElement( tpixeldata );
}
pixeldata.SetVR( gdcm::VR::OW );
gdcm::VL bv2l = bv2->GetLength();
gdcm::VL at1l = at1.GetValue() * at2.GetValue() * 2; /* sizeof(unsigned short) == 2 */
// Handle special case that is not compressed:
if( bv2l == at1l )
{
    pixeldata.SetByteValue( bv2->GetPointer(), bv2->GetLength() );
}
else
{
    std::vector<unsigned short> buffer;
    delta_decode(bv2->GetPointer(), bv2->GetLength(), buffer);
    pixeldata.SetByteValue( (char*)&buffer[0], (uint32_t)(buffer.size() * sizeof( unsigned short ) ) );
}
// TODO we should check that decompress byte buffer match the expected size (row*col*...)
// Add the pixel data element
if( reader.GetFile().GetDataSet().FindDataElement( tpixeldata ) )
{
    reader.GetFile().GetDataSet().Replace( pixeldata );
}
else
{
    reader.GetFile().GetDataSet().ReplaceEmpty( pixeldata );
}
reader.GetFile().GetHeader().SetDataSetTransferSyntax(
    gdcm::TransferSyntax::ExplicitVRLittleEndian);
gdcm::Writer writer;
writer.SetFile( reader.GetFile() );
// Cleanup stuff:
// This makes the code equivalent to Philips workstation IntelliSpace Portal
if( writer.GetFile().GetDataSet().FindDataElement( tcompressiontype ) )
{
    writer.GetFile().GetDataSet().Remove( gdcm::Tag(0x07a1,0x1011) );
}
if( writer.GetFile().GetDataSet().FindDataElement( tprivatepixeldata ) )
{
    writer.GetFile().GetDataSet().Remove( gdcm::Tag(0x07a1,0x100a) );
}
std::string outfilename;
if (argc > 2)
    outfilename = argv[2];
else
    outfilename = "outrle.dcm";
writer.SetFileName( outfilename.c_str() );
if( !writer.Write() )
{
    std::cerr << "Failed to write" << std::endl;
    return 1;
}
std::cout << "success !" << std::endl;
return 0;
}

```



## 12.103 uid\_unique.cxx

```

/*=====
Program: GDCM (Grassroots DICOM). A DICOM library

Copyright (c) 2006-2011 Mathieu Malaterre
All rights reserved.
See Copyright.txt or http://gdcml.sourceforge.net/Copyright.html for details.

This software is distributed WITHOUT ANY WARRANTY; without even
the implied warranty of MERCHANTABILITY or FITNESS FOR A PARTICULAR
PURPOSE. See the above copyright notice for more information.
=====*/
#include "gdcmlUIDGenerator.h"
#include <iostream>
#include <string>
#include <set>
int main()
{
    gdcml::UIDGenerator uid;
    //const char myroot[] = "9876543210.9876543210.9876543210.9876543210.9876543210"; // fails in ~40000 tries
    const char myroot[] = "9876543210.9876543210.9876543210";
    uid.SetRoot( myroot );
    std::set<std::string> uids;
    uint64_t wrap = 0;
    uint64_t c = 0;
    while(true)
    {
        const char *unique = uid.Generate();
        //std::cout << unique << std::endl;
        if( c % 10000 == 0 )
        {
            std::cout << "wrap=" << wrap << ",c=" << c << std::endl;
        }
        ++c;
        if( c == 0 )
        {
            wrap++;
        }
        if ( uids.count(unique) == 1 )
        {
            std::cerr << "Failed with: " << unique << std::endl;
            return 1;
        }
        uids.insert( unique );
    }
}

```

## 12.104 DecompressImage.java

```

/*=====
Program: GDCM (Grassroots DICOM). A DICOM library

Copyright (c) 2006-2011 Mathieu Malaterre
All rights reserved.
See Copyright.txt or http://gdcml.sourceforge.net/Copyright.html for details.

This software is distributed WITHOUT ANY WARRANTY; without even
the implied warranty of MERCHANTABILITY or FITNESS FOR A PARTICULAR
PURPOSE. See the above copyright notice for more information.
=====*/
/*
 * This example will take in a DICOM file, and tries to decompress it (actually write it
 * as ImplicitVRLittleEndian Transfer Syntax).
 *
 * Compilation:
 * $ CLASSPATH=gdcml.jar javac ../../gdcml/Examples/Java/DecompressImage.java -d .
 *
 * Usage:
 * $ LD_LIBRARY_PATH=. CLASSPATH=gdcml.jar:. java DecompressImage gdcmlData/012345.002.050.dcm out.dcm
 */
import gdcml.*;
public class DecompressImage

```

```

{
    public static void main(String[] args) throws Exception
    {
        String file1 = args[0];
        String file2 = args[1];
        ImageReader reader = new ImageReader();
        reader.SetFileName( file1 );
        boolean ret = reader.Read();
        if( !ret )
        {
            throw new Exception("Could not read: " + file1 );
        }
        ImageChangeTransferSyntax change = new ImageChangeTransferSyntax();
        change.SetTransferSyntax( new TransferSyntax(TransferSyntax.TSType.ImplicitVRLittleEndian) );
        change.SetInput( reader.GetImage() );
        if( !change.Change() )
        {
            throw new Exception("Could not change: " + file1 );
        }
        Image out = change.GetOutput();
        System.out.println( out.toString() );
        // Set the Source Application Entity Title
        FileMetaInformation.SetSourceApplicationEntityTitle( "Just For Fun" );
        ImageWriter writer = new ImageWriter();
        writer.SetFileName( file2 );
        writer.SetFile( reader.GetFile() );
        writer.SetImage( out );
        ret = writer.Write();
        if( !ret )
        {
            throw new Exception("Could not write: " + file2 );
        }
    }
}

```

## 12.105 DecompressPixmap.java

```

/*=====
Program: GDCM (Grassroots DICOM). A DICOM library

Copyright (c) 2006-2011 Mathieu Malaterre
All rights reserved.
See Copyright.txt or http://gdcm.sourceforge.net/Copyright.html for details.

This software is distributed WITHOUT ANY WARRANTY; without even
the implied warranty of MERCHANTABILITY or FITNESS FOR A PARTICULAR
PURPOSE. See the above copyright notice for more information.
=====*/
/*
 * This example will take in a DICOM file, and tries to decompress it (actually write it
 * as ImplicitVRLittleEndian Transfer Syntax).
 *
 * Compilation:
 * $ CLASSPATH=gdcm.jar javac ../../gdcm/Examples/Java/DecompressPixmap.java -d .
 *
 * Usage:
 * $ LD_LIBRARY_PATH=. CLASSPATH=gdcm.jar:. java DecompressPixmap gdcmData/012345.002.050.dcm out.dcm
 */
import gdcm.*;
public class DecompressPixmap
{
    public static void main(String[] args) throws Exception
    {
        String file1 = args[0];
        String file2 = args[1];
        PixmapReader reader = new PixmapReader();
        reader.SetFileName( file1 );
        boolean ret = reader.Read();
        if( !ret )
        {
            throw new Exception("Could not read: " + file1 );
        }
        ImageChangeTransferSyntax change = new ImageChangeTransferSyntax();
        change.SetTransferSyntax( new TransferSyntax(TransferSyntax.TSType.ImplicitVRLittleEndian) );
        PixmapToPixmapFilter filter = (PixmapToPixmapFilter)change;

```

```

filter.SetInput( reader.GetPixmap() );
if( !change.Change() )
{
    throw new Exception("Could not change: " + file1 );
}
// The following does not work in Java/swig 2.0.7
//Pixmap p = ((PixmapToPixmapFilter)change).GetOutput();
Pixmap p = change.GetOutputAsPixmap(); // be explicit
//System.out.println( p.toString() );
// Set the Source Application Entity Title
FileMetaInformation.SetSourceApplicationEntityTitle( "Just For Fun" );
PixmapWriter writer = new PixmapWriter();
writer.SetFileName( file2 );
writer.SetFile( reader.GetFile() );
writer.SetImage( p );
ret = writer.Write();
if( !ret )
{
    throw new Exception("Could not write: " + file2 );
}
}
}

```

## 12.106 ExtractImageRegion.java

```

/*=====
Program: GDCM (Grassroots DICOM). A DICOM library

Copyright (c) 2006-2011 Mathieu Malaterre
All rights reserved.
See Copyright.txt or http://gdcm.sourceforge.net/Copyright.html for details.

This software is distributed WITHOUT ANY WARRANTY; without even
the implied warranty of MERCHANTABILITY or FITNESS FOR A PARTICULAR
PURPOSE. See the above copyright notice for more information.

=====*/
/*
 * This small code shows how to use the gdcm.ImageRegionReader API
 * In this example we are taking each frame by frame and dump them to
 * /tmp/frame.raw.
 *
 * Usage:
 * $ LD_LIBRARY_PATH=. CLASSPATH=gdcm.jar:. java ExtractImageRegion input.dcm
 */
import gdcm.*;
import java.io.FileOutputStream;
public class ExtractImageRegion
{
    public static void main(String[] args) throws Exception
    {
        String filename = args[0];
        // instantiate the reader:
        ImageRegionReader reader = new ImageRegionReader();
        reader.SetFileName( filename );
        // pull DICOM info:
        if (!reader.ReadInformation()) return;
        // Get file infos
        File f = reader.GetFile();
        // get some info about image
        UIntArrayType dims = ImageHelper.GetDimensionsValue(f);
        PixelFormat pf = ImageHelper.GetPixelFormatValue (f);
        int pixelsize = pf.GetPixelFormatSize();
        // buffer to get the pixels
        long buffer_length = dims.get(0) * dims.get(1) * pixelsize;
        byte[] buffer = new byte[ (int)buffer_length ];
        // define a simple box region.
        BoxRegion box = new BoxRegion();
        for (int z = 0; z < dims.get(2); z++)
        {
            // Define that I want the image 0, full size (dimx x dimy pixels)
            // and do that for each z:
            box.SetDomain(0, dims.get(0) - 1, 0, dims.get(1) - 1, z, z);
            //System.Console.WriteLine( box.toString() );
            reader.SetRegion( box );
            // reader will try to load the uncompressed image region into buffer.

```

```

// the call returns an error when buffer.Length is too small. For instance
// one can call:
// long buf_len = reader.ComputeBufferLength(); // take into account pixel size
// to get the exact size of minimum buffer
if (reader.ReadIntoBuffer(buffer, buffer_length))
{
    FileOutputStream fos = new FileOutputStream("/tmp/frame.raw");
    fos.write(buffer);
    fos.close();
}
else
{
    throw new Exception("can't read pixels error");
}
}
}
}

```

## 12.107 FileAnonymize.java

```

/*=====
Program: GDCM (Grassroots DICOM). A DICOM library

Copyright (c) 2006-2011 Mathieu Malaterre
All rights reserved.
See Copyright.txt or http://gdcm.sourceforge.net/Copyright.html for details.

This software is distributed WITHOUT ANY WARRANTY; without even
the implied warranty of MERCHANTABILITY or FITNESS FOR A PARTICULAR
PURPOSE. See the above copyright notice for more information.

=====*/
import gdcm.*;
public class FileAnonymize
{
    public static class MyWatcher extends SimpleSubjectWatcher
    {
        public MyWatcher(Subject s) { super(s,"Override String"); }
        protected void ShowProgress(Subject caller, Event evt)
        {
            ProgressEvent pe = ProgressEvent.Cast(evt);
            System.out.println( "This is my progress: " + pe.GetProgress() );
        }
    }
    public static void main(String[] args) throws Exception
    {
        String input = args[0];
        String output = args[1];
        FileAnonymizer fa = new FileAnonymizer();
        fa.SetInputFileName( input );
        fa.SetOutputFileName( output );
        // Empty Operations
        // It will create elements, since those tags are non-registered public elements (2011):
        fa.Empty( new Tag(0x0008,0x1313) );
        fa.Empty( new Tag(0x0008,0x1317) );
        // Remove Operations
        // The following Tag are actually carefully chosen, since they refer to SQ:
        fa.Remove( new Tag(0x0008,0x2112) );
        fa.Remove( new Tag(0x0008,0x9215) );
        // Replace Operations
        // do not call replace operation on SQ attribute !
        fa.Replace( new Tag(0x0018,0x5100), "MYVALUE " );
        fa.Replace( new Tag(0x0008,0x1160), "MYOTHERVAL" );
        if( !fa.Write() )
        {
            System.out.println( "Could not write" );
            return;
        }
        System.out.println( "success" );
    }
}

```

## 12.108 HelloSimple.java

```

/*=====
Program: GDCM (Grassroots DICOM). A DICOM library

Copyright (c) 2006-2011 Mathieu Malaterre
All rights reserved.
See Copyright.txt or http://gdcml.sourceforge.net/Copyright.html for details.

This software is distributed WITHOUT ANY WARRANTY; without even
the implied warranty of MERCHANTABILITY or FITNESS FOR A PARTICULAR
PURPOSE. See the above copyright notice for more information.

=====*/
/*
 * Compilation:
 * $ CLASSPATH=gdcml.jar javac ../../gdcml/Examples/Java/HelloSimple.java -d .
 *
 * Usage:
 * $ LD_LIBRARY_PATH=. CLASSPATH=gdcml.jar:. java HelloSimple gdcmlData/012345.002.050.dcm
 */
import gdcml.*;
public class HelloSimple
{
    public static void main(String[] args) throws Exception
    {
        String filename = args[0];
        Reader reader = new Reader();
        reader.SetFileName( filename );
        boolean ret = reader.Read();
        if( !ret )
        {
            throw new Exception("Could not read: " + filename );
        }
        File f = reader.GetFile();
        DataSet ds = f.GetDataSet();
        System.out.println( ds.toString() );
        System.out.println("Success reading: " + filename );
    }
}

```

## 12.109 ReadFiles.java

```

/*=====
Program: GDCM (Grassroots DICOM). A DICOM library

Copyright (c) 2006-2011 Mathieu Malaterre
All rights reserved.
See Copyright.txt or http://gdcml.sourceforge.net/Copyright.html for details.

This software is distributed WITHOUT ANY WARRANTY; without even
the implied warranty of MERCHANTABILITY or FITNESS FOR A PARTICULAR
PURPOSE. See the above copyright notice for more information.

=====*/
import gdcml.*;
import java.io.File;
public class ReadFiles
{
    static int i = 0;
    public static void process(String path)
    {
        //String path = file.getPath();
        assert PosixEmulation.FileExists(path) : "Problem converting to 8bits";
        System.out.println("Reading: " + path );
        System.out.println("File: " + i++);
        Reader r = new Reader();
        try
        {
            r.SetFileName( path );
            TagSetType skip = new TagSetType();
            skip.insert( new Tag(0x7fe0,0x10) );
            boolean b = r.ReadUpToTag( new Tag(0x88,0x200), skip );
            //System.out.println("DS:\n" + r.GetFile().GetDataSet().toString() );
        }
    }
}

```

```

        finally
        {
            r.delete(); // will properly call C++ destructor and close file descriptor
        }
    }
    // Process only files under dir
    public static void visitAllFiles(File dir)
    {
        if (dir.isDirectory())
        {
            String[] children = dir.list();
            for (int i=0; i<children.length; i++)
            {
                visitAllFiles(new File(dir, children[i]));
            }
        }
        else
        {
            process(dir.getPath());
        }
    }
    public static void waiting (int n)
    {
        long t0, t1;
        t0 = System.currentTimeMillis();
        do
        {
            t1 = System.currentTimeMillis();
        }
        while ((t1 - t0) < (n * 1000));
    }
    public static void main(String[] args) throws Exception
    {
        String directory = args[0];
        Directory gdir = new Directory();
        long n = gdir.Load( directory, true );
        System.out.println( gdir.toString() );
        FilenamesType files = gdir.GetFilesNames();
        for( long i = 0; i < n; ++i )
        {
            String path = files.get( (int)i );
            process( path );
        }
        System.out.println( "Java API" );
        //waiting( 10 );
        for( int i = 0; i < 2; ++i )
        {
            File dir = new File(directory);
            visitAllFiles(dir);
        }
    }
}

```

## 12.110 ScanDirectory.java

```

/*=====
Program: GDCM (Grassroots DICOM). A DICOM library

Copyright (c) 2006-2011 Mathieu Malaterre
All rights reserved.
See Copyright.txt or http://gdcml.sourceforge.net/Copyright.html for details.

This software is distributed WITHOUT ANY WARRANTY; without even
the implied warranty of MERCHANTABILITY or FITNESS FOR A PARTICULAR
PURPOSE. See the above copyright notice for more information.

=====*/
import gdcml.*;
import gdcml.Reader;
import gdcml.LookupTable;
import java.io.File;
import java.io.*;
import java.awt.image.*;
import javax.imageio.ImageIO;
public class ScanDirectory
{

```

```

public static class MyWatcher extends SimpleSubjectWatcher
{
    public MyWatcher(Subject s) { super(s,"Override String"); }
    protected void ShowProgress(Subject caller, Event evt)
    {
        ProgressEvent pe = ProgressEvent.Cast(evt);
        System.out.println( "This is my progress: " + pe.GetProgress() );
    }
}

public static byte[] GetAsByte(Bitmap input)
{
    long len = input.GetBufferLength();
    byte[] buffer = new byte[ (int)len ];
    PhotometricInterpretation pi = input.GetPhotometricInterpretation();
    if( pi.GetType() == PhotometricInterpretation.PIType.MONOCHROME1 )
    {
        ImageChangePhotometricInterpretation icpi = new ImageChangePhotometricInterpretation();
        icpi.SetInput( input );
        icpi.SetPhotometricInterpretation(
            new PhotometricInterpretation(
                PhotometricInterpretation.PIType.MONOCHROME2 ) );
        if( icpi.Change() )
        {
            Bitmap output = icpi.GetOutput();
            output.GetArray( buffer );
        }
        return buffer;
    }
    else
    {
        input.GetArray( buffer );
        return buffer;
    }
}

public static short[] GetAsShort(Bitmap input)
{
    long len = input.GetBufferLength(); // length in bytes
    short[] buffer = new short[ (int)len / 2 ];
    PhotometricInterpretation pi = input.GetPhotometricInterpretation();
    if( pi.GetType() == PhotometricInterpretation.PIType.MONOCHROME1 )
    {
        ImageChangePhotometricInterpretation icpi = new ImageChangePhotometricInterpretation();
        icpi.SetInput( input );
        icpi.SetPhotometricInterpretation(
            new PhotometricInterpretation(
                PhotometricInterpretation.PIType.MONOCHROME2 ) );
        if( icpi.Change() )
        {
            Bitmap output = icpi.GetOutput();
            output.GetArray( buffer );
        }
        return buffer;
    }
    else
    {
        input.GetArray( buffer );
        return buffer;
    }
}

public static boolean WritePNG(Bitmap input, String outfilename )
{
    int imageType = BufferedImage.TYPE_CUSTOM;
    PixelFormat pf = input.GetPixelFormat();
    PhotometricInterpretation pi = input.GetPhotometricInterpretation();
    // We need to handle both public and private icon
    // It could well be that we are getting an RGB Icon or 16 bits Icon:
    ColorModel colorModel = null;
    if( pf.GetSamplesPerPixel() == 1 )
    {
        if( pi.GetType() == PhotometricInterpretation.PIType.MONOCHROME1
            || pi.GetType() == PhotometricInterpretation.PIType.MONOCHROME2 )
        {
            if( pf.GetScalarType() == PixelFormat.ScalarType.UINT8 )
            {
                imageType = BufferedImage.TYPE_BYTE_GRAY;
            }
            else if( pf.GetScalarType() == PixelFormat.ScalarType.UINT12 )
            {
                imageType = BufferedImage.TYPE_USHORT_GRAY;
            }
            else if( pf.GetScalarType() == PixelFormat.ScalarType.UINT16 )

```

```

        {
            imageType = BufferedImage.TYPE_USHORT_GRAY;
        }
    }
    else if( pi.GetType() == PhotometricInterpretation.PIType.PALETTE_COLOR )
    {
        LookupTable lut = input.GetLUT();
        long r1 = lut.GetLUTLength( LookupTable.LookupTableType.RED );
        byte[] rbuf = new byte[ (int)r1 ];
        long r12 = lut.GetLUT( LookupTable.LookupTableType.RED, rbuf );
        assert r1 == r12;
        long g1 = lut.GetLUTLength( LookupTable.LookupTableType.GREEN );
        byte[] gbuf = new byte[ (int)g1 ];
        long g12 = lut.GetLUT( LookupTable.LookupTableType.GREEN, gbuf );
        assert g1 == g12;
        long b1 = lut.GetLUTLength( LookupTable.LookupTableType.BLUE );
        byte[] bbuf = new byte[ (int)b1 ];
        long b12 = lut.GetLUT( LookupTable.LookupTableType.BLUE, bbuf );
        assert b1 == b12;
        colorModel = new IndexColorModel(8, (int)r1, rbuf, gbuf, bbuf);
        // For code below
        imageType = BufferedImage.TYPE_BYTE_GRAY;
    }
}
else if( pf.GetSamplesPerPixel() == 3 )
{
    if( pf.GetScalarType() == PixelFormat.ScalarType.UINT8 )
    {
        // FIXME should be TYPE_3BYTE_RGB
        imageType = BufferedImage.TYPE_3BYTE_BGR;
    }
}
//System.out.println( "pf: " + pf.toString() );
//System.out.println( "pi: " + pi.toString() );
long width = input.GetDimension(0);
long height = input.GetDimension(0);
BufferedImage bi;
if( pi.GetType() == PhotometricInterpretation.PIType.PALETTE_COLOR )
{
    bi = new BufferedImage(colorModel,
        colorModel.createCompatibleWritableRaster((int)width, (int)height),
        false, null);
}
else
{
    bi = new BufferedImage((int)width, (int)height, imageType);
}
WritableRaster wr = bi.getRaster();
//System.out.println( "imagetype: " + imageType );
if( imageType == BufferedImage.TYPE_BYTE_GRAY
    || imageType == BufferedImage.TYPE_3BYTE_BGR )
{
    byte[] buffer = GetAsByte( input );
    wr.setDataElements( 0, 0, (int)width, (int)height, buffer);
}
else if( imageType == BufferedImage.TYPE_USHORT_GRAY )
{
    short[] buffer = GetAsShort( input );
    wr.setDataElements( 0, 0, (int)width, (int)height, buffer);
}
File outputfile = new File( outfilename );
try {
    ImageIO.write(bi, "png", outputfile);
} catch (IOException e) {
    return false;
}
return true;
}
public static void main(String[] args) throws Exception
{
    String directory = args[0];
    Directory d = new Directory();
    long nfiles = d.Load( directory, true );
    if(nfiles == 0)
    {
        throw new Exception("No files found");
    }
    // System.out.println( "Files:\n" + d.toString() );
    FilenamesType fns = d.GetFilenames();
    //Scanner s = new Scanner();
    SmartPtrScan sscan = Scanner.New();

```



```

Scanner s = sscan.__ref__();
//SimpleSubjectWatcher watcher = new SimpleSubjectWatcher(s, "MySimple");
MyWatcher watcher = new MyWatcher(s);
Tag[] tagarray = {
    new Tag(0x0010, 0x0010),    // PatientName
    new Tag(0x0010, 0x0020),    // PatientID
    new Tag(0x0010, 0x0030),    // PatientBirthDate
    new Tag(0x0010, 0x0040),    // PatientSex
    new Tag(0x0010, 0x1010),    // PatientAge
    new Tag(0x0020, 0x000d),    // StudyInstanceUID
    new Tag(0x0020, 0x0010),    // StudyID
    new Tag(0x0008, 0x0020),    // StudyDate
    new Tag(0x0008, 0x1030),    // StudyDescription
    new Tag(0x0020, 0x000e),    // SeriesInstanceUID
    new Tag(0x0020, 0x0011),    // SeriesNumber
    new Tag(0x0008, 0x0021),    // SeriesDate
    new Tag(0x0008, 0x103e),    // SeriesDescription
    new Tag(0x0008, 0x0090),    // ReferringPhysicianName
    new Tag(0x0008, 0x0060),    // Modality
    new Tag(0x0054, 0x0400),    // ImageID ?? Should be Instance number ??
    new Tag(0x0008, 0x0018),    // SOPInstanceUID
    new Tag(0x0008, 0x0032),    // AcquisitionTime
    new Tag(0x0008, 0x0033),    // ContentTime
    new Tag(0x0020, 0x0013),    // InstanceNumber
    new Tag(0x0020, 0x1041),    // SliceLocation
    new Tag(0x0018, 0x0050),    // SliceThickness ?? Eg. Enhanced MR Image Storage
    new Tag(0x0008, 0x0080),    // InstitutionName
    new Tag(0x0028, 0x1050),    // WindowCenter
    new Tag(0x0028, 0x1051),    // WindowWidth
};
for( Tag t : tagarray ) {
    //System.out.println( "Tag: " + t.toString() );
    s.AddTag( t );
}
boolean b = s.Scan( fns );
if(!b)
{
    throw new Exception("Could not scan");
}
String fn0 = fns.get(0);
TagToValue mappings = s.GetMapping( fn0 );
System.out.println( "mappings size: " + mappings.size() );
for( Tag tag : tagarray ) {
    if( mappings.has_key( tag ) ) {
        String val = mappings.get( tag );
        System.out.println( "tag/val: " + tag + "->" + val );
    }
}
for( long idx = 0; idx < fns.size(); ++idx )
{
    Reader r = new Reader();
    String fn = fns.get( (int)idx );
    String outfn = fn + ".png";
    r.SetFileName( fn );
    TagSetType tst = new TagSetType();
    tst.insert( new Tag(0x7fe0,0x10) );
    b = r.ReadUpToTag( new Tag(0x88,0x200), tst );
    UIntArrayType dims = ImageHelper.GetDimensionsValue( r.GetFile() );
    if( b )
    {
        IconImageFilter iif = new IconImageFilter();
        System.out.println( "Processing: " + fn );
        iif.SetFile( r.GetFile() );
        b = iif.Extract();
        if( b )
        {
            Bitmap icon = iif.GetIconImage(0);
            WritePNG(icon, outfn);
        }
    }
    else
    {
        ImageReader ir = new ImageReader();
        ir.SetFileName( fn );
        if( ir.Read() )
        {
            Image img = ir.GetImage();
            StringFilter sf = new StringFilter();
            sf.SetFile( r.GetFile() );
            String strval = sf.ToString( new Tag(0x0028,0x0120) );
            IconImageGenerator iig = new IconImageGenerator();
            iig.SetPixmap( img );
        }
    }
}

```

```

        iig.AutoPixelMinMax( true );
        try {
            double val = Double.parseDouble( strval );
            iig.SetOutsideValuePixel( val );
        }
        catch ( NumberFormatException e) {
        }
        iig.ConvertRGBToPaletteColor( false );
        long idims[] = { 128, 128};
        iig.SetOutputDimensions( idims );
        iig.Generate();
        Bitmap icon = iig.GetIconImage();
        WritePNG(icon, outfn);
    }
}
}
System.out.println( "Scan:\n" + s.toString() );
System.out.println( "success" );
}
}
}

```

## 12.111 SimplePrint.java

```

/*=====
Program: GDCM (Grassroots DICOM). A DICOM library

Copyright (c) 2006-2011 Mathieu Malaterre
All rights reserved.
See Copyright.txt or http://gdcm.sourceforge.net/Copyright.html for details.

This software is distributed WITHOUT ANY WARRANTY; without even
the implied warranty of MERCHANTABILITY or FITNESS FOR A PARTICULAR
PURPOSE. See the above copyright notice for more information.

=====*/
/*
 * Compilation:
 * $ CLASSPATH=gdcm.jar javac ../../gdcm/Examples/Java/SimplePrint.java -d .
 *
 * Usage:
 * $ LD_LIBRARY_PATH=. CLASSPATH=gdcm.jar:. java SimplePrint gdcmData/012345.002.050.dcm
 */
import gdcm.*;
public class SimplePrint
{
    public static void RecurseDataSet(File f, DataSet ds, String indent)
    {
        JavaDataSet cds = new JavaDataSet(ds);
        while(!cds.IsAtEnd())
        {
            DataElement de = cds.GetCurrent();
            // Compute VR from the toplevel file, and the currently processed dataset:
            VR vr = DataSetHelper.ComputeVR(f, ds, de.GetTag() );
            if( vr.Compatible( new VR(VR.VRType.SQ) ) )
            {
                long uvl = de.GetVL().GetValueLength(); // Test cast is ok
                System.out.println( indent + de.GetTag().toString() + ":" + uvl ); // why not ?
                //SequenceOfItems sq = de.GetSequenceOfItems();
                // GetValueAsSQ handle more cases than GetSequenceOfItems
                SmartPtrSQ sq = de.GetValueAsSQ();
                long n = sq.GetNumberOfItems();
                for( long i = 1; i <= n; i++) // item starts at 1, not 0
                {
                    Item item = sq.GetItem( i );
                    DataSet nested = item.GetNestedDataSet();
                    RecurseDataSet( f, nested, indent + " " );
                }
            }
            else
            {
                System.out.println( indent + de.toString() );
            }
            cds.Next();
        }
    }
}

```

```
public static void main(String[] args) throws Exception
{
    String filename = args[0];
    Reader reader = new Reader();
    reader.SetFileName( filename );
    boolean ret = reader.Read();
    if( !ret )
    {
        throw new Exception("Could not read: " + filename );
    }
    File f = reader.GetFile();
    DataSet ds = f.GetDataSet();
    RecurseDataSet( f, ds, "" );
}
}
```

## 12.112 AddPrivateAttribute.py

```
1
14
15 """
16 Usage:
17
18 python AddPrivateAttribute.py input.dcm output.dcm
19
20
21 """
22
23 import sys
24 import gdcm
25
26 if __name__ == "__main__":
27
28     file1 = sys.argv[1]
29     file2 = sys.argv[2]
30
31     r = gdcm.Reader()
32     r.SetFileName( file1 )
33     if not r.Read():
34         sys.exit(1)
35
36     f = r.GetFile()
37     ds = f.GetDataSet()
38
39     # Create a dataelement
40     de = gdcm.DataElement(gdcm.Tag(0x0051, 0x1011))
41     de.SetByteStringValue("p2")
42     de.SetVR(gdcm.VR(gdcm.VR.SH))
43
44     ds.Insert(de)
45
46     w = gdcm.Writer()
47     w.SetFile( f )
48     w.SetFileName( file2 )
49     if not w.Write():
50         sys.exit(1)
```

## 12.113 ConvertMPL.py

```
1
14
15 """
16 display a DICOM image with matplotlib via numpy
17
18 Caveats:
19 - Does not support UINT12/INT12
20
21 Usage:
22
23 python ConvertNumpy.py "IM000000"
24
25 Thanks:
26 plotting example - Ray Schumacher 2009
```

```

27 """
28
29 import gdcM
30 import numpy
31 from pylab import *
32
33
34 def get_gdcm_to_numpy_typemap():
35     """Returns the GDCM Pixel Format to numpy array type mapping."""
36     _gdcm_np = {gdcm.PixelFormat.UINT8 :numpy.int8,
37                gdcm.PixelFormat.INT8 :numpy.uint8,
38                gdcm.PixelFormat.UINT16 :numpy.uint16,
39                gdcm.PixelFormat.INT16 :numpy.int16,
40                gdcm.PixelFormat.UINT32 :numpy.uint32,
41                gdcm.PixelFormat.INT32 :numpy.int32,
42                gdcm.PixelFormat.FLOAT32 :numpy.float32,
43                gdcm.PixelFormat.FLOAT64 :numpy.float64 }
44     return _gdcm_np
45
46 def get_numpy_array_type(gdcm_pixel_format):
47     """Returns a numpy array typecode given a GDCM Pixel Format."""
48     return get_gdcm_to_numpy_typemap()[gdcm_pixel_format]
49
50 def gdcm_to_numpy(image):
51     """Converts a GDCM image to a numpy array.
52     """
53     pf = image.GetPixelFormat().GetScalarType()
54     print 'pf', pf
55     print image.GetPixelFormat().GetScalarTypeAsString()
56     assert pf in get_gdcm_to_numpy_typemap().keys(), \
57            "Unsupported array type %s"%pf
58     d = image.GetDimension(0), image.GetDimension(1)
59     print 'Image Size: %d x %d' % (d[0], d[1])
60     dtype = get_numpy_array_type(pf)
61     gdcm_array = image.GetBuffer()
62
63     result = numpy.frombuffer(gdcm_array, dtype=dtype).astype(float)
64
65     result.shape = d
66     return result
67
68
69 if __name__ == "__main__":
70     import sys
71     r = gdcM.ImageReader()
72     filename = sys.argv[1]
73     r.SetFileName( filename )
74     if not r.Read(): sys.exit(1)
75     numpy_array = gdcm_to_numpy( r.GetImage() )
76
77     subplot(111)# one plot, on left
78     title(filename)
79
80     imshow(numpy_array, interpolation='bilinear', cmap=cm.jet)
81
82     subplots_adjust(bottom=0.1, right=0.8, top=0.9)
83     cax = axes([0.85, 0.1, 0.075, 0.8])
84     colorbar(cax=cax)
85     title('values')
86     get_current_fig_manager().window.title('plot')
87     show()

```

## 12.114 ConvertNumpy.py

```

1
14
15 """
16 This module add support for converting a gdcm.Image to a numpy array.
17
18 Caveats:
19 - Does not support UINT12/INT12
20
21 Removed:
22 - float16 is defined in GDCM API but no implementation exist for it ...
23 """
24
25 import gdcM
26 import numpy

```

```

27
28 def get_gdcm_to_numpy_typemap():
29     """Returns the GDCM Pixel Format to numpy array type mapping."""
30     _gdcm_np = {gdcm.PixelFormat.UINT8 :numpy.uint8,
31                 gdcm.PixelFormat.INT8 :numpy.int8,
32                 #gdcm.PixelFormat.UINT12 :numpy.uint12,
33                 #gdcm.PixelFormat.INT12 :numpy.int12,
34                 gdcm.PixelFormat.UINT16 :numpy.uint16,
35                 gdcm.PixelFormat.INT16 :numpy.int16,
36                 gdcm.PixelFormat.UINT32 :numpy.uint32,
37                 gdcm.PixelFormat.INT32 :numpy.int32,
38                 #gdcm.PixelFormat.FLOAT16 :numpy.float16,
39                 gdcm.PixelFormat.FLOAT32 :numpy.float32,
40                 gdcm.PixelFormat.FLOAT64 :numpy.float64 }
41     return _gdcm_np
42
43 def get_numpy_array_type(gdcm_pixel_format):
44     """Returns a numpy array typecode given a GDCM Pixel Format."""
45     return get_gdcm_to_numpy_typemap()[gdcm_pixel_format]
46
47 def gdcm_to_numpy(image):
48     """Converts a GDCM image to a numpy array.
49     """
50     pf = image.GetPixelFormat()
51
52     assert pf.GetScalarType() in get_gdcm_to_numpy_typemap().keys(), \
53         "Unsupported array type %s"%pf
54
55     shape = image.GetDimension(0) * image.GetDimension(1), pf.GetSamplesPerPixel()
56     if image.GetNumberOfDimensions() == 3:
57         shape = shape[0] * image.GetDimension(2), shape[1]
58
59     dtype = get_numpy_array_type(pf.GetScalarType())
60     gdcm_array = image.GetBuffer()
61     result = numpy.frombuffer(gdcm_array, dtype=dtype)
62     result.shape = shape
63     return result
64
65 if __name__ == "__main__":
66     import sys
67     r = gdcm.ImageReader()
68     filename = sys.argv[1]
69     r.SetFileName( filename )
70     if not r.Read():
71         sys.exit(1)
72
73     numpy_array = gdcm_to_numpy( r.GetImage() )
74     print numpy_array

```

## 12.115 ConvertPIL.py

```

1
14
15 """
16 save a DICOM image with PIL via numpy
17
18 Caveats:
19 - Does not support UINT12/INT12
20
21 Usage:
22
23 python ConvertNumpy.py "IM000000"
24
25 Thanks:
26 plotting example - Ray Schumacher 2009
27 """
28
29 import gdcm
30 import numpy
31 from PIL import Image, ImageOps
32
33
34 def get_gdcm_to_numpy_typemap():
35     """Returns the GDCM Pixel Format to numpy array type mapping."""
36     _gdcm_np = {gdcm.PixelFormat.UINT8 :numpy.int8,
37                 gdcm.PixelFormat.INT8 :numpy.uint8,
38                 gdcm.PixelFormat.UINT16 :numpy.uint16,

```

```

39         gdcM.PixelFormat.INT16 :numpy.int16,
40         gdcM.PixelFormat.UINT32 :numpy.uint32,
41         gdcM.PixelFormat.INT32 :numpy.int32,
42         gdcM.PixelFormat.FLOAT32:numpy.float32,
43         gdcM.PixelFormat.FLOAT64:numpy.float64 }
44     return _gdcM_np
45
46 def get_numpy_array_type(gdcM_pixel_format):
47     """Returns a numpy array typecode given a GDCM Pixel Format."""
48     return get_gdcM_to_numpy_typedmap()[gdcM_pixel_format]
49
50 def gdcM_to_numpy(image):
51     """Converts a GDCM image to a numpy array.
52     """
53     pf = image.GetPixelFormat().GetScalarType()
54     print 'pf', pf
55     print image.GetPixelFormat().GetScalarTypeAsString()
56     assert pf in get_gdcM_to_numpy_typedmap().keys(), \
57         "Unsupported array type %s"%pf
58     d = image.GetDimension(0), image.GetDimension(1)
59     print 'Image Size: %d x %d' % (d[0], d[1])
60     dtype = get_numpy_array_type(pf)
61     gdcM_array = image.GetBuffer()
62     result = numpy.frombuffer(gdcM_array, dtype=dtype)
63     maxV = float(result[result.argmax()])
64
65     result = numpy.log(result+50)
66     maxV = float(result[result.argmax()])
67     result = result*(2.**8/maxV)
68     result.shape = d
69     return result
70
71 if __name__ == "__main__":
72     import sys
73     r = gdcM.ImageReader()
74     filename = sys.argv[1]
75     r.SetFileName( filename )
76     if not r.Read(): sys.exit(1)
77     numpy_array = gdcM_to_numpy( r.GetImage() )
78
79     pilImage = Image.frombuffer('L',
80                               numpy_array.shape,
81                               numpy_array.astype(numpy.uint8),
82                               'raw','L',0,1)
83
84     pilImage = ImageOps.autocontrast(pilImage, cutoff=.1)
85     pilImage.save(sys.argv[1]+'.jpg')

```

## 12.116 CreateRAWStorage.py

```

1
14
15 """
16     <uid value="1.2.840.10008.5.1.4.1.1.66" name="Raw Data Storage" type="SOP Class" part="PS 3.4"
17     retired="false"/>
18 """
19 import gdcM
20 import sys,os
21
22 if __name__ == "__main__":
23     r = gdcM.Reader()
24     # Will require Testing...
25     dataroot = gdcM.Testing.GetDataRoot()
26     filename = os.path.join( dataroot, '012345.002.050.dcm' )
27     r.SetFileName( filename )
28     r.Read()
29     f = r.GetFile()
30     ds = f.GetDataSet()
31
32     uid = "1.2.840.10008.5.1.4.1.1.66"
33     # f = gdcM.File()
34     # ds = f.GetDataSet()
35     de = gdcM.DataElement( gdcM.Tag(0x0008,0x0016) )
36     de.SetByteStringValue( uid )
37     vr = gdcM.VR( gdcM.VR.UI )
38     de.SetVR( vr )

```

```
39 ds.Replace( de )
40
41 ano = gdcm.Anonymizer()
42 ano.SetFile( r.GetFile() )
43 ano.RemovePrivateTags()
44 ano.RemoveGroupLength()
45 taglist = [
46 gdcm.Tag(0x0008,0x0008),
47 gdcm.Tag(0x0008,0x0022),
48 gdcm.Tag(0x0008,0x0032),
49 gdcm.Tag(0x0008,0x2111),
50 gdcm.Tag(0x0008,0x1150),
51 gdcm.Tag(0x0008,0x1155),
52 gdcm.Tag(0x0008,0x0100),
53 gdcm.Tag(0x0008,0x0102),
54 gdcm.Tag(0x0008,0x0104),
55 gdcm.Tag(0x0040,0xa170),
56 gdcm.Tag(0x0008,0x2112),
57 gdcm.Tag(0x0008,0x0100),
58 gdcm.Tag(0x0008,0x0102),
59 gdcm.Tag(0x0008,0x0104),
60 gdcm.Tag(0x0008,0x9215),
61 gdcm.Tag(0x0018,0x0010),
62 gdcm.Tag(0x0018,0x0022),
63 gdcm.Tag(0x0018,0x0050),
64 gdcm.Tag(0x0018,0x0060),
65 gdcm.Tag(0x0018,0x0088),
66 gdcm.Tag(0x0018,0x0090),
67 gdcm.Tag(0x0018,0x1040),
68 gdcm.Tag(0x0018,0x1100),
69 gdcm.Tag(0x0018,0x1110),
70 gdcm.Tag(0x0018,0x1111),
71 gdcm.Tag(0x0018,0x1120),
72 gdcm.Tag(0x0018,0x1130),
73 gdcm.Tag(0x0018,0x1150),
74 gdcm.Tag(0x0018,0x1151),
75 gdcm.Tag(0x0018,0x1152),
76 gdcm.Tag(0x0018,0x1160),
77 gdcm.Tag(0x0018,0x1190),
78 gdcm.Tag(0x0018,0x1210),
79 gdcm.Tag(0x0020,0x0012),
80 gdcm.Tag(0x0020,0x0032),
81 gdcm.Tag(0x0020,0x0037),
82 gdcm.Tag(0x0020,0x1041),
83 gdcm.Tag(0x0020,0x4000),
84 gdcm.Tag(0x0028,0x0002),
85 gdcm.Tag(0x0028,0x0004),
86 gdcm.Tag(0x0028,0x0010),
87 gdcm.Tag(0x0028,0x0011),
88 gdcm.Tag(0x0028,0x0030),
89 gdcm.Tag(0x0028,0x0100),
90 gdcm.Tag(0x0028,0x0101),
91 gdcm.Tag(0x0028,0x0102),
92 gdcm.Tag(0x0028,0x0103),
93 gdcm.Tag(0x0028,0x1052),
94 gdcm.Tag(0x0028,0x1053),
95 gdcm.Tag(0x0028,0x2110),
96 gdcm.Tag(0x0028,0x2112),
97 gdcm.Tag(0x7fe0,0x0010),
98 gdcm.Tag(0x0018,0x0020),
99 gdcm.Tag(0x0018,0x0021),
100 gdcm.Tag(0x0018,0x0023),
101 gdcm.Tag(0x0018,0x0025),
102 gdcm.Tag(0x0018,0x0080),
103 gdcm.Tag(0x0018,0x0081),
104 gdcm.Tag(0x0018,0x0083),
105 gdcm.Tag(0x0018,0x0084),
106 gdcm.Tag(0x0018,0x0085),
107 gdcm.Tag(0x0018,0x0086),
108 gdcm.Tag(0x0018,0x0087),
109 gdcm.Tag(0x0018,0x0091),
110 gdcm.Tag(0x0018,0x0093),
111 gdcm.Tag(0x0018,0x0094),
112 gdcm.Tag(0x0018,0x0095),
113 gdcm.Tag(0x0018,0x1088),
114 gdcm.Tag(0x0018,0x1090),
115 gdcm.Tag(0x0018,0x1094),
116 gdcm.Tag(0x0018,0x1250),
117 gdcm.Tag(0x0018,0x1251),
118 gdcm.Tag(0x0018,0x1310),
119 gdcm.Tag(0x0018,0x1312),
```

```

120  gdcM.Tag(0x0018,0x1314),
121  gdcM.Tag(0x0018,0x1315),
122  gdcM.Tag(0x0018,0x1316),
123  gdcM.Tag(0x0020,0x0110),
124  gdcM.Tag(0x0028,0x0120),
125  gdcM.Tag(0x0028,0x1050),
126  gdcM.Tag(0x0028,0x1051)
127  ]
128  for tag in taglist:
129      #print tag
130      ano.Remove( tag )
131
132  # special handling
133  gen = gdcM.UIDGenerator()
134  ano.Replace( gdcM.Tag(0x0008,0x9123), gen.Generate() )
135  #ano.Empty( gdcM.Tag(0x0040,0x0555) )
136
137
138  #
139  # uid = gen.Generate()
140  # de.SetTag( gdcM.Tag(0x0008,0x0018) )
141  # de.SetByteStringValue( uid )
142  # ds.Insert( de )
143
144  # init FMI now:
145  #fmi = f.GetHeader()
146  #ts = gdcM.TransferSyntax()
147  #print ts
148  #fmi.SetDataSetTransferSyntax( ts ) # default
149  #print fmi.GetDataSetTransferSyntax()
150  #de.SetTag( gdcM.Tag(0x0002,0x0010) )
151  #uid = "1.2.840.10008.1.2"
152  #de.SetByteStringValue( uid )
153  #fmi.Insert( de )
154  # f.SetHeader( r.GetFile().GetHeader() )
155
156  writer = gdcM.Writer()
157  writer.SetFile( ano.GetFile() )
158  writer.SetFileName( "rawstorage.dcm" );
159  writer.Write()

```

## 12.117 DecompressImage.py

```

1
14
15 """
16 Usage:
17
18 python DecompressImage.py gdcMData/012345.002.050.dcm decompress.dcm
19 """
20
21 import gdcM
22 import sys
23
24 if __name__ == "__main__":
25
26     file1 = sys.argv[1]
27     file2 = sys.argv[2]
28
29     r = gdcM.ImageReader()
30     r.SetFileName( file1 )
31     if not r.Read():
32         sys.exit(1)
33
34     # check GetFragment API:
35     pd = r.GetFile().GetDataSet().GetDataElement(gdcM.Tag(0x7fe0, 0x0010))
36     frags = pd.GetSequenceOfFragments();
37     frags.GetFragment(0);
38
39     ir = r.GetImage()
40     w = gdcM.ImageWriter()
41     image = w.GetImage()
42
43     image.SetNumberOfDimensions( ir.GetNumberOfDimensions() );
44     dims = ir.GetDimensions();
45     print ir.GetDimension(0);
46     print ir.GetDimension(1);

```



```

47 print "Dims:",dims
48
49 # Just for fun:
50 dircos = ir.GetDirectionCosines()
51 t = gdcm.Orientation.GetType(tuple(dircos))
52 l = gdcm.Orientation.GetLabel(t)
53 print "Orientation label:",l
54
55 image.SetDimension(0, ir.GetDimension(0) );
56 image.SetDimension(1, ir.GetDimension(1) );
57
58 pixeltype = ir.GetPixelFormat();
59 image.SetPixelFormat( pixeltype );
60
61 pi = ir.GetPhotometricInterpretation();
62 image.SetPhotometricInterpretation( pi );
63
64 pixeldata = gdcm.DataElement( gdcm.Tag(0x7fe0,0x0010) )
65 str1 = ir.GetBuffer()
66 #print ir.GetBufferLength()
67 pixeldata.SetByteStringValue( str1 )
68 image.SetDataElement( pixeldata )
69
70 w.SetFileName( file2 )
71 w.SetFile( r.GetFile() )
72 w.SetImage( image )
73 if not w.Write():
74     sys.exit(1)

```

## 12.118 DumbAnonymizer.py

```

1
14
15 """
16 This example shows how one can use the gdcm.Anonymizer in 'dumb' mode.
17 This class becomes really handy when one knows which particular tag to fill in.
18
19 Usage:
20
21 python DumbAnonymizer.py gdcmData/012345.002.050.dcm out.dcm
22
23 """
24
25 import gdcm
26
27 # http://www.oid-info.com/get/1.3.6.1.4.17434
28 THERALYS_ORG_ROOT = "1.3.6.1.4.17434"
29
30 tag_rules={
31     # Value
32     (0x0012,0x0010):("Value","MySponsorName"),
33     (0x0012,0x0020):("Value","MyProtocolID"),
34     (0x0012,0x0021):("Value","MyProtocolName"),
35     (0x0012,0x0062):("Value","YES"),
36     (0x0012,0x0063):("Value","MyDeidentificationMethod"),
37
38     # Method
39     #(0x0002,0x0003):("Method","GenerateMSOPId"),
40     #(0x0008,0x1155):("Method","GenerateMSOPId"),
41     (0x0008,0x0018):("Method","GenerateMSOPId"),
42     (0x0010,0x0010):("Method","GetSponsorInitials"),
43     (0x0010,0x0020):("Method","GetSponsorId"),
44     (0x0012,0x0030):("Method","GetSiteId"),
45     (0x0012,0x0031):("Method","GetSiteName"),
46     (0x0012,0x0040):("Method","GetSponsorId"),
47     (0x0012,0x0050):("Method","GetTPId"),
48     (0x0018,0x0022):("Method","KeepIfExist"),
49     (0x0018,0x1315):("Method","KeepIfExist"),
50     (0x0020,0x000d):("Method","GenerateStudyId"),
51     (0x0020,0x000e):("Method","GenerateSeriesId"),
52     (0x0020,0x1002):("Method","GetNumberOfFrames"),
53     (0x0020,0x0020):("Method","GetPatientOrientation"),
54     # Other:
55     (0x0012,0x0051):("Patient Field","Type Examen"),
56     (0x0018,0x1250):("Sequence Field","Receive Coil"),
57     (0x0018,0x0088):("Sequence Field","Spacing Between Slice"),
58     (0x0018,0x0095):("Sequence Field","Pixel Bandwidth"),

```

```

59 (0x0018,0x0082):("Sequence Field","Inverction Time"),
60 }
61
62 class MyAnon:
63     def __init__(self):
64         self.studyuid = None
65         self.seriesuid = None
66         generator = gdcms.UIDGenerator()
67         if not self.studyuid:
68             self.studyuid = generator.Generate()
69         if not self.seriesuid:
70             self.seriesuid = generator.Generate()
71     def GetSponsorInitials(self):
72         return "dummy^foobar"
73     def GenerateStudyId(self):
74         return self.studyuid
75     def GenerateSeriesId(self):
76         return self.seriesuid
77     #def GenerateMSOPId(self):
78     def GenerateMSOPId(self):
79         generator = gdcms.UIDGenerator()
80         return generator.Generate()
81     def GetSiteId(self):
82         return "MySiteId"
83     def GetSiteName(self):
84         return "MySiteName"
85     def GetSponsorId(self):
86         return "MySponsorId"
87     def GetTPId(self):
88         return "MyTP"
89
90 if __name__ == "__main__":
91     import sys
92     gdcms.FileMetaInformation.SetSourceApplicationEntityTitle( "DumbAnonymizer" )
93     gdcms.UIDGenerator.SetRoot( THERALYS_ORG_ROOT )
94
95     r = gdcms.Reader()
96     filename = sys.argv[1]
97     r.SetFileName( filename )
98     if not r.Read(): sys.exit(1)
99
100     obj = MyAnon()
101
102     w = gdcms.Writer()
103     ano = gdcms.Anonymizer()
104     ano.SetFile( r.GetFile() )
105     ano.RemoveGroupLength()
106     for tag,rule in tag_rules.items():
107         if rule[0] == 'Value':
108             print tag,rule
109             ano.Replace( gdcms.Tag( tag[0], tag[1] ), rule[1] )
110         elif rule[0] == 'Method':
111             print tag,rule
112             # result = locals()[rule[1]]()
113             methodname = rule[1]
114             if hasattr(obj, methodname):
115                 _member = getattr(obj, methodname)
116                 result = _member()
117                 ano.Replace( gdcms.Tag( tag[0], tag[1] ), result )
118             else:
119                 print "Problem with: ", methodname
120
121     outfilename = sys.argv[2]
122     w.SetFileName( outfilename )
123     w.SetFile( ano.GetFile() )
124     if not w.Write(): sys.exit(1)

```

## 12.119 ExtractImageRegion.py

```

1
14
15 """
16
17 This small code shows how to use the gdcms.ImageRegionReader API
18 In this example we are taking each frame by frame and dump them to
19 /tmp/frame.raw.
20

```

```

21 Usage:
22 $ ExtractImageRegion.py input.dcm
23
24 Example:
25 $ ExtractImageRegion.py gdcmlData/012345.002.050.dcm
26 $ md5sum /tmp/frame.raw
27 d594a5e2fde12f32b6633ca859b4d4a6 /tmp/frame.raw
28 $ gdcminfo --md5sum gdcmlData/012345.002.050.dcm
29 [...]
30 md5sum: d594a5e2fde12f32b6633ca859b4d4a6
31 """
32
33 import gdcml
34
35 if __name__ == "__main__":
36     import sys
37     filename = sys.argv[1]
38
39     file_size = gdcml.System.FileSize(filename);
40
41     # instantiate the reader:
42     reader = gdcml.ImageRegionReader();
43     reader.SetFileName( filename );
44
45     # pull DICOM info:
46     if not reader.ReadInformation():
47         sys.exit(1)
48
49     # store current offset:
50     cur_pos = reader.GetStreamCurrentPosition();
51
52     remaining = file_size - cur_pos;
53
54     print("Remaining bytes to read (Pixel Data): %d" % remaining );
55
56     # Get file infos
57     f = reader.GetFile();
58
59     # get some info about image
60     dims = gdcml.ImageHelper.GetDimensionsValue(f);
61     print(dims)
62     pf = gdcml.ImageHelper.GetPixelFormatValue(f);
63     pixelsize = pf.GetPixelFormat();
64     pi = gdcml.ImageHelper.GetPhotometricInterpretationValue(f);
65     print( pi );
66
67     # buffer to get the pixels
68     buffer = bytearray( dims[0] * dims[1] * pixelsize )
69
70     # define a simple box region.
71     box = gdcml.BoxRegion();
72     for z in range(0, dims[2]):
73         # Define that I want the image 0, full size (dimx x dimy pixels)
74         # and do that for each z:
75         box.SetDomain(0, dims[0] - 1, 0, dims[1] - 1, z, z);
76         #print( box.toString() );
77         reader.SetRegion( box );
78
79         # reader will try to load the uncompressed image region into buffer.
80         # the call returns an error when buffer.Length is too small. For instance
81         # one can call:
82         # uint buf_len = reader.ComputeBufferLength(); // take into account pixel size
83         # to get the exact size of minimum buffer
84         if reader.ReadIntoBuffer(buffer):
85             open('/tmp/frame.raw', 'wb').write(buffer)
86         else:
87             #throw new Exception("can't read pixels error");
88             sys.exit(1)

```

## 12.120 FindAllPatientName.py

```

1
14 """
15 This example shows how one can use the gdcml.CompositeNetworkFunctions class
16 for executing a C-FIND query
17 It will print the list of patient name found
18

```

```

19 Usage:
20
21 python FindAllPatientName.py
22
23 """
24
25 import gdcM
26
27 # Patient Name
28 tag = gdcM.Tag(0x10,0x10)
29 de = gdcM.DataElement(tag)
30
31 # Search all patient name where string match 'F*'
32 de.SetByteStringValue('F*')
33
34 ds = gdcM.DataSet()
35 ds.Insert(de)
36
37 cnf = gdcM.CompositeNetworkFunctions()
38 theQuery = cnf.ConstructQuery(gdcM.ePatientRootType,gdcM.ePatient,ds)
39
40 #print theQuery.ValidateQuery()
41
42 # prepare the variable for output
43 ret = gdcM.DataSetArrayType()
44
45 # Execute the C-FIND query
46 cnf.CFind('dicom.example.com',11112,theQuery,ret,'GDCM_PYTHON','ANY-SCP')
47
48 for i in range(0,ret.size()):
49     print "Patient #",i
50     print ret[i]

```

## 12.121 FixCommaBug.py

```

1
14
15 """
16 Using LC_NUMERIC set to something not compatible with "C" it is possible to write out "," instead of
17 "." as required by the DICOM standard
18 Issue is still current (IMHO) with gdcM 2.0.9
19 """
20
21 import gdcM
22 import sys
23
24 filename = sys.argv[1]
25 outname = sys.argv[2]
26
27 # read
28 r = gdcM.Reader()
29 r.SetFileName( filename )
30 if not r.Read():
31     print "not valid"
32     sys.exit(1)
33
34 file = r.GetFile()
35 dataset = file.GetDataSet()
36
37 ano = gdcM.Anonymizer()
38 ano.SetFile( file )
39
40 tags = [
41 gdcM.Tag(0x0018,0x1164),
42 gdcM.Tag(0x0018,0x0088),
43 gdcM.Tag(0x0018,0x0050),
44 gdcM.Tag(0x0028,0x0030),
45 ]
46
47 for tag in tags:
48     print tag
49     if dataset.FindDataElement( tag ):
50         pixelspacing = dataset.GetDataElement( tag )
51         #print pixelspacing
52         bv = pixelspacing.GetByteValue()
53         str = bv.GetBuffer()
54         #print bv.GetLength()

```

```

55     #print len(str)
56     new_str = str.replace(",",".")
57     # Need to explicitly pass bv.GetLength() to remove any trailing garbage
58     ano.Replace( tag, new_str, bv.GetLength() )
59
60 #print dataset
61
62 w = gdcm.Writer()
63 w.SetFile( file )
64 w.SetFileName( outname )
65 if not w.Write():
66     print "Cannot write"
67     sys.exit(1)
68
69 # paranoid:
70 image_reader = gdcm.ImageReader()
71 image_reader.SetFileName( outname )
72 if not image_reader.Read():
73     print "there is still a comma"
74     sys.exit(1)
75
76 print "Sucess!"
77 sys.exit(0) # success

```

## 12.122 GetPortionCSAHeader.py

```

1
14
15 """
16 Usage:
17
18 python GetPortionCSAHeader.py input.dcm
19
20 Footnote:
21 SIEMENS is not publishing any information on the CSA header. So any info extracted
22 is at your own risk.
23 """
24
25 import sys
26 import gdcm
27
28 if __name__ == "__main__":
29
30     file = sys.argv[1]
31
32     r = gdcm.Reader()
33     r.SetFileName( file )
34     if not r.Read():
35         sys.exit(1)
36
37     ds = r.GetFile().GetDataSet()
38     csa_t1 = gdcm.CSAHeader()
39     csa_t2 = gdcm.CSAHeader()
40     #print csa
41     t1 = csa_t1.GetCSAImageHeaderInfoTag();
42     print t1
43     t2 = csa_t2.GetCSASeriesHeaderInfoTag();
44     print t2
45     # Let's do it for t1:
46     if ds.FindDataElement( t1 ):
47         csa_t1.LoadFromDataElement( ds.GetDataElement( t1 ) )
48         print csa_t1
49
50     # Now let's pretend we are only interested in B_value and DiffusionGradientDirection entries:
51     bvalues = csa_t1.GetCSAElementByName( "B_value" ) # WARNING: it is case sensitive !
52     print bvalues
53
54     diffgraddir = csa_t1.GetCSAElementByName( "DiffusionGradientDirection" ) # WARNING: it is case sensitive !
55     print diffgraddir
56
57     # repeat for t2 if you like it:
58     if ds.FindDataElement( t2 ):
59         csa_t2.LoadFromDataElement( ds.GetDataElement( t2 ) )
60         # print csa_t2
61
62     gdt = csa_t2.GetCSAElementByName( "GradientDelayTime" )
63     print gdt

```

```

64
65 bv = gdt.GetByteValue();
66 #print bv
67 str = bv.GetPointer()
68 print str.split("\\")

```

## 12.123 HelloWorld.py

```

1
14
15 """
16 Hello World !
17 """
18
19 import gdcM
20 import sys
21
22 if __name__ == "__main__":
23
24     # verbosity:
25     #gdcM.Trace.DebugOn()
26     #gdcM.Trace.WarningOn()
27     #gdcM.Trace.ErrorOn()
28
29     # Get the filename from the command line
30     filename = sys.argv[1]
31
32     # Instanciate a gdcM.Reader
33     # This is the main class to handle any type of DICOM object
34     # You should check for gdcM.ImageReader for reading specifically DICOM Image file
35     r = gdcM.Reader()
36     r.SetFileName( filename )
37     # If the reader fails to read the file, we should stop !
38     if not r.Read():
39         print "Not a valid DICOM file"
40         sys.exit(1)
41
42     # Get the DICOM File structure
43     file = r.GetFile()
44
45     # Get the DataSet part of the file
46     dataset = file.GetDataSet()
47
48     # Ok let's print it !
49     print dataset
50
51     # Use StringFilter to print a particular Tag:
52     sf = gdcM.StringFilter()
53     sf.SetFile(r.GetFile())
54
55     # Check if Attribute exist
56     print dataset.FindDataElement( gdcM.Tag(0x0028,0x0010))
57
58     # Let's print it as string pair:
59     print sf.ToStringPair(gdcM.Tag(0x0028,0x0010))

```

## 12.124 ManipulateFile.py

```

1
14
15 """
16 Usage:
17
18 python ManipulateFile.py input.dcm output.dcm
19
20 Footnote:
21 GDCM 1.2.x would create incorrect Multiframe MR Image Storage file. Try to recover from
22 the issues to recreate a MultiframeGrayscaleByteSecondaryCaptureImageStorage file.
23 e.g:
24
25 python ManipulateFile.py Insight/Testing/Temporary/itkGDCMImageIOTest5-j2k.dcm manipulated.dcm
26 """
27

```

```

28 import sys
29 import gdcm
30
31 if __name__ == "__main__":
32
33     file1 = sys.argv[1]
34     file2 = sys.argv[2]
35
36     r = gdcm.Reader()
37     r.SetFileName( file1 )
38     if not r.Read():
39         sys.exit(1)
40
41     ano = gdcm.Anonymizer()
42     ano.SetFile( r.GetFile() )
43     ano.RemovePrivateTags()
44     ano.Remove( gdcm.Tag(0x0032,0x1030) )
45     ano.Remove( gdcm.Tag(0x008,0x14) )
46     ano.Remove( gdcm.Tag(0x008,0x1111) )
47     ano.Remove( gdcm.Tag(0x008,0x1120) )
48     ano.Remove( gdcm.Tag(0x008,0x1140) )
49     ano.Remove( gdcm.Tag(0x10,0x21b0) )
50     ano.Empty( gdcm.Tag(0x10,0x10) )
51     ano.Empty( gdcm.Tag(0x10,0x20) )
52     ano.Empty( gdcm.Tag(0x10,0x30) )
53     ano.Empty( gdcm.Tag(0x20,0x10) )
54     ano.Empty( gdcm.Tag(0x32,0x1032) )
55     ano.Empty( gdcm.Tag(0x32,0x1033) )
56     ano.Empty( gdcm.Tag(0x40,0x241) )
57     ano.Empty( gdcm.Tag(0x40,0x254) )
58     ano.Empty( gdcm.Tag(0x40,0x253) )
59     ano.Empty( gdcm.Tag(0x40,0x1001) )
60     ano.Empty( gdcm.Tag(0x8,0x80) )
61     ano.Empty( gdcm.Tag(0x8,0x50) )
62     ano.Empty( gdcm.Tag(0x8,0x1030) )
63     ano.Empty( gdcm.Tag(0x8,0x103e) )
64     ano.Empty( gdcm.Tag(0x18,0x1030) )
65     ano.Empty( gdcm.Tag(0x38,0x300) )
66     g = gdcm.UIDGenerator()
67     ano.Replace( gdcm.Tag(0x0008,0x0018), g.Generate() )
68     ano.Replace( gdcm.Tag(0x0020,0x000d), g.Generate() )
69     ano.Replace( gdcm.Tag(0x0020,0x000e), g.Generate() )
70     ano.Replace( gdcm.Tag(0x0020,0x0052), g.Generate() )
71     #ano.Replace( gdcm.Tag(0x0008,0x0016), "1.2.840.10008.5.1.4.1.1.7.2" )
72     """
73     ano.Remove( gdcm.Tag(0x0018,0x0020) ) # ScanningSequence
74     ano.Remove( gdcm.Tag(0x0018,0x0021) ) # SequenceVariant
75     ano.Remove( gdcm.Tag(0x0018,0x0022) ) # ScanOptions
76     ano.Remove( gdcm.Tag(0x0018,0x0023) ) # MRAcquisitionType
77     ano.Remove( gdcm.Tag(0x0018,0x0050) ) # SliceThickness
78     ano.Remove( gdcm.Tag(0x0018,0x0080) ) # RepetitionTime
79     ano.Remove( gdcm.Tag(0x0018,0x0081) ) # EchoTime
80     ano.Remove( gdcm.Tag(0x0018,0x0088) ) # SpacingBetweenSlices
81     ano.Remove( gdcm.Tag(0x0018,0x0091) ) # EchoTrainLength
82     ano.Remove( gdcm.Tag(0x0018,0x1164) ) # ImagerPixelSpacing
83
84     ano.Remove( gdcm.Tag(0x0020,0x0032) ) # Image Position (Patient)
85     ano.Remove( gdcm.Tag(0x0020,0x0037) ) # Image Orientation (Patient)
86     ano.Remove( gdcm.Tag(0x0020,0x0052) ) # Frame of Reference UID
87     ano.Remove( gdcm.Tag(0x0020,0x1040) ) # Position Reference Indicator
88
89     ano.Replace( gdcm.Tag(0x0028,0x0301), "NO" ) # Burned In Annotation
90
91     ano.Empty( gdcm.Tag(0x0020,0x0020) )
92
93     ano.Remove( gdcm.Tag(0x7fe0,0x0000) )
94
95     #ano.Empty( gdcm.Tag(0x0028,0x0009) ) # Frame Increment Pointer
96
97     #ano.Empty( gdcm.Tag(0x0028,0x1052) ) #<entry group="0028" element="1052" vr="DS" vm="1" name="Rescale
Intercept"/>
98     #ano.Empty( gdcm.Tag(0x0028,0x1053) ) #<entry group="0028" element="1053" vr="DS" vm="1" name="Rescale
Slope"/>
99     #ano.Replace( gdcm.Tag(0x0028,0x1054), "US" ) #<entry group="0028" element="1054" vr="LO" vm="1"
name="Rescale Type"/>
100
101     ano.Replace( gdcm.Tag(0x2050, 0x0020), "IDENTITY")
102     """
103
104     w = gdcm.Writer()
105     w.SetFile( ano.GetFile() )

```

```

106 w.SetFileName( file2 )
107 if not w.Write():
108     sys.exit(1)

```

## 12.125 ManipulateSequence.py

```

1
14
15 """
16 Usage:
17
18 python ManipulateSequence.py input.dcm output.dcm
19
20 This was tested using:
21
22 python ManipulateSequence.py gdcmlData/D_CLUNIE_CT1_J2KI.dcm myoutput.dcm
23
24 This is a dummy example on how to modify a value set in a nested-nested dataset
25
26 WARNING:
27 Do not use as-is in production, this is just an example
28 This example works in an undefined length Item only (you need to explicitly recompute the length otherwise)
29 """
30
31 import sys
32 import gdcml
33
34 if __name__ == "__main__":
35
36     file1 = sys.argv[1]
37     file2 = sys.argv[2]
38
39     r = gdcml.Reader()
40     r.SetFileName( file1 )
41     if not r.Read():
42         sys.exit(1)
43
44     f = r.GetFile()
45     ds = f.GetDataSet()
46     tsis = gdcml.Tag(0x0008,0x2112) # SourceImageSequence
47     if ds.FindDataElement( tsis ):
48         sis = ds.GetDataElement( tsis )
49         #sqsis = sis.GetSequenceOfItems()
50         # GetValueAsSQ handle more cases
51         sqsis = sis.GetValueAsSQ()
52         if sqsis.GetNumberOfItems():
53             item1 = sqsis.GetItem(1)
54             nestedds = item1.GetNestedDataSet()
55             tprcs = gdcml.Tag(0x0040,0x170) # PurposeOfReferenceCodeSequence
56             if nestedds.FindDataElement( tprcs ):
57                 prcs = nestedds.GetDataElement( tprcs )
58                 sqprcs = prcs.GetSequenceOfItems()
59                 if sqprcs.GetNumberOfItems():
60                     item2 = sqprcs.GetItem(1)
61                     nestedds2 = item2.GetNestedDataSet()
62                     # (0008,0104) LO [Uncompressed predecessor] # 24, 1 CodeMeaning
63                     tcm = gdcml.Tag(0x0008,0x0104)
64                     if nestedds2.FindDataElement( tcm ):
65                         cm = nestedds2.GetDataElement( tcm )
66                         mystr = "GDCM was here"
67                         cm.SetByteStringValue( mystr )
68
69     w = gdcml.Writer()
70     w.SetFile( f )
71     w.SetFileName( file2 )
72     if not w.Write():
73         sys.exit(1)

```

## 12.126 MergeFile.py

```

1
14
15 """

```



```

16 Usage:
17
18 python MergeFile.py input1.dcm input2.dcm
19
20 It will produce a 'merge.dcm' output file, which contains all meta information from input1.dcm
21 and copy the Stored Pixel values from input2.dcm
22 This script even works when input2.dcm is a Secondary Capture and does not contains information
23 such as IOP and IPP...
24 """
25
26 import sys
27 import gdcm
28
29 if __name__ == "__main__":
30
31     file1 = sys.argv[1]
32     file2 = sys.argv[2]
33
34     r1 = gdcm.ImageReader()
35     r1.SetFileName( file1 )
36     if not r1.Read():
37         sys.exit(1)
38
39     r2 = gdcm.ImageReader()
40     r2.SetFileName( file2 )
41     if not r2.Read():
42         sys.exit(1)
43
44     # Image from r2 could be Secondary Capture and thus would not contains neither IPP nor IOP
45     # Instead always prefer to only copy the Raw Data Element.
46     # Warning ! Image need to be identical ! Only the value of Stored Pixel can be different.
47     r1.GetImage().SetDataElement( r2.GetImage().GetDataElement() )
48
49     w = gdcm.ImageWriter()
50     w.SetFile( r1.GetFile() )
51     #w.SetImage( r2.GetImage() ) # See comment above
52     w.SetImage( r1.GetImage() )
53
54     w.SetFileName( "merge.dcm" )
55     if not w.Write():
56         sys.exit(1)
57
58     sys.exit(0)

```

## 12.127 NewSequence.py

```

1
14
15 """
16 Usage:
17
18 python NewSequence.py input.dcm output.dcm
19
20
21 Thanks to Robert Irie for code
22 """
23
24 import sys
25 import gdcm
26
27 if __name__ == "__main__":
28
29     file1 = sys.argv[1]
30     file2 = sys.argv[2]
31
32     r = gdcm.Reader()
33     r.SetFileName( file1 )
34     if not r.Read():
35         sys.exit(1)
36
37     f = r.GetFile()
38     ds = f.GetDataSet()
39     #tsis = gdcm.Tag(0x0008,0x2112) # SourceImageSequence
40
41     # Create a dataelement
42     de = gdcm.DataElement( gdcm.Tag(0x0010, 0x2180) )
43     de.SetByteStringValue("Occupation")

```

```

44 de.SetVR(gdcm.VR(gdcm.VR.SH))
45
46 # Create an item
47 it=gdcm.Item()
48 it.SetVLToUndefined() # Needed to not popup error message
49 #it.InsertDataElement(de)
50 nds=it.GetNestedDataSet()
51 nds.Insert(de)
52
53 # Create a Sequence
54 sq=gdcm.SequenceOfItems().New()
55 sq.SetLengthToUndefined()
56 sq.AddItem(it)
57
58 # Insert sequence into data set
59 des=gdcm.DataElement(gdcm.Tag(0x0400,0x0550))
60 des.SetVR(gdcm.VR(gdcm.VR.SQ))
61 des.SetValue(sq.__ref__())
62 des.SetVLToUndefined()
63
64 ds.Insert(des)
65
66 w = gdcm.Writer()
67 w.SetFile( f )
68 w.SetFileName( file2 )
69 if not w.Write():
70     sys.exit(1)

```

## 12.128 PhilipsPrivateRescaleInterceptSlope.py

```

1
14
15 """
16 Usage:
17
18 python
19 """
20
21 import gdcm
22 import sys
23
24 filename = sys.argv[1]
25 tmpfile = "/tmp/philips_rescaled.dcm"
26
27
28 # Need to access some private tags, read the file :
29 reader = gdcm.Reader()
30 reader.SetFileName( filename )
31 if not reader.Read():
32     sys.exit(1)
33
34 ds = reader.GetFile().GetDataSet()
35
36 #print ds
37 # (2005,1409) DS 4 0.0
38 # (2005,140a) DS 16 1.52283272283272
39
40 # (2005,0014) LO 26 Philips MR Imaging DD 005
41 tag1 = gdcm.PrivateTag(0x2005,0x09,"Philips MR Imaging DD 005")
42 tag2 = gdcm.PrivateTag(0x2005,0x0a,"Philips MR Imaging DD 005")
43 print tag1
44 print tag2
45
46 # make sure to do a copy, we want the private tag to remain
47 # otherwise gdcm gives us a reference
48 e11 = gdcm.DataElement( ds.GetDataElement( tag1 ) )
49 print e11
50 e12 = gdcm.DataElement( ds.GetDataElement( tag2 ) )
51 print e12
52
53 # (0028,1052) DS [-1000] # 6, 1 RescaleIntercept
54 # (0028,1053) DS [1] # 2, 1 RescaleSlope
55
56 e11.SetTag( gdcm.Tag(0x0028,0x1052) )
57 e12.SetTag( gdcm.Tag(0x0028,0x1053) )
58
59 ds.Insert( e11 )

```

```

60 ds.Insert( el2 )
61
62 w = gdcm.Writer()
63 w.SetCheckFileMetaInformation( False )
64 w.SetFileName( tmpfile )
65 w.SetFile( reader.GetFile() )
66 if not w.Write():
67     sys.exit(1)
68
69 print "success"

```

## 12.129 PlaySound.py

```

1
14
15 """
16 Usage:
17
18 python PlaySound.py input.dcm
19 """
20
21 import gdcm
22 import sys
23
24 #filename = "/home/mmalaterre/Creatis/gdcmDataExtra/gdcmNonImageData/audio_from_rafael_sanguinetti.dcm"
25 filename = sys.argv[1]
26 print filename
27
28 r = gdcm.Reader()
29 r.SetFileName( filename )
30 if not r.Read():
31     sys.exit(1)
32
33 ds = r.GetFile().GetDataSet()
34
35 waveformtag = gdcm.Tag(0x5400,0x0100)
36 waveformsq = ds.GetDataElement( waveformtag )
37 #print waveformsq
38
39 #print dir(waveformsq)
40
41 items = waveformsq.GetSequenceOfItems()
42
43 if not items.GetNumberOfItems():
44     sys.exit(1)
45
46 item = items.GetItem(1)
47 #print item
48
49 waveformds = item.GetNestedDataSet()
50 #print waveformds
51
52 waveformdatatag = gdcm.Tag(0x5400,0x1010)
53 waveformdata = waveformds.GetDataElement( waveformdatatag )
54
55 #print waveformdata.GetPointer()
56 bv = waveformdata.GetByteValue()
57 print dir(bv)
58
59 #print bv.GetPointer()
60 print bv.GetLength()
61 l = 116838
62
63 file='test.wav'
64 myfile = open(file, "wb")
65 s = bv.GetPointer()
66 for i in range(0, l):
67     myfile.write(s[i])
68 myfile.close()
69
70 # http://mail.python.org/pipermail/python-list/2004-October/288905.html
71 if sys.platform.startswith('win'):
72     from winsound import PlaySound, SND_FILENAME, SND_ASYNC
73     PlaySound(file, SND_FILENAME|SND_ASYNC)
74 elif sys.platform.find('linux')>-1:
75     from wave import open as waveOpen
76     from ossaudiodev import open as ossOpen

```

```

77 s = waveOpen(file,'rb')
78 (nc,sw,fr,nf,comptype, compname) = s.getparams()
79 dsp = ossOpen('/dev/dsp','w')
80 try:
81     from ossaudiodev import AFMT_S16_NE
82 except ImportError:
83     if byteorder == "little":
84         AFMT_S16_NE = ossaudiodev.AFMT_S16_LE
85     else:
86         AFMT_S16_NE = ossaudiodev.AFMT_S16_BE
87 dsp.setparameters(AFMT_S16_NE, nc, fr)
88 data = s.readframes(nf)
89 s.close()
90 dsp.write(data)
91 dsp.close()

```

## 12.130 PrivateDict.py

```

1
14
15 """
16 """
17
18 import gdcM
19 import sys,os
20
21 if __name__ == "__main__":
22     #gdcM.Trace.DebugOn()
23     globInst = gdcM.Global.GetInstance()
24     # Try to load Part3.xml file
25     # This file is too big for being accessible directly at runtime.
26     globInst.LoadResourcesFiles()
27
28
29     # Get a private tag from the runtime dicts. LoadResourcesFiles could
30     # have failed but this has no impact on the private dict
31
32     d = globInst.GetDicts()
33     print d.GetDictEntry( gdcM.Tag(0x0029,0x0010) ,"SIEMENS CSA HEADER" )
34     pd = d.GetPrivateDict()
35     print pd.GetDictEntry( gdcM.PrivateTag(0x0029,0x0010,"SIEMENS CSA HEADER" )

```

## 12.131 ReWriteSCAsMR.py

```

1
14
15 """
16 GDCM 1.x would write out MR Image Storage as Secondary Capture Object while still setting Rescale
17 Slope/Intercept
18 and saving the Pixel Spacing in (0028,0030)
19 """
20
21 import gdcM
22 import sys,os
23
24 def CheckSecondaryCaptureObjectIsMRImageStorage(r):
25     ds = r.GetFile().GetDataSet()
26     # Check Source Image Sequence
27     if ds.FindDataElement( gdcM.Tag(0x0008,0x2112) ):
28         sis = ds.GetDataElement( gdcM.Tag(0x0008,0x2112) )
29         sqsis = sis.GetSequenceOfItems()
30         if sqsis.GetNumberOfItems():
31             item1 = sqsis.GetItem(1)
32             nestedds = item1.GetNestedDataSet()
33             if nestedds.FindDataElement( gdcM.Tag(0x0008,0x1150) ):
34                 ReferencedSOPClassUID = nestedds.GetDataElement( gdcM.Tag(0x0008,0x1150) )
35                 raw = ReferencedSOPClassUID.GetByteValue().GetPointer()
36                 uids = gdcM.UIDs()
37                 # what is the actual object we are looking at ?
38                 ms = gdcM.MediaStorage()
39                 ms.SetFromDataSet(ds)
40                 msuid = ms.GetString()
41                 uids.SetFromUID( msuid )

```

```

41     msuidname = uids.GetName() # real Media Storage Name
42     uids.SetFromUID( raw )
43     sqmsuidname = uids.GetName() # Source Image Sequence Media Storage Name
44     # If object is SC and Source derivation is MRImageStorage then we can assume 'Pixel Spacing' is
    correct
45     if( sqmsuidname == 'MR Image Storage' and msuidname == 'Secondary Capture Image Storage' ):
46         return True
47     # in all other case simply return the currentspacing:
48     return False
49
50 if __name__ == "__main__":
51     r = gdcM.ImageReader()
52     filename = sys.argv[1]
53     r.SetFileName( filename )
54     if not r.Read():
55         sys.exit(1)
56     f = r.GetFile()
57
58     if( CheckSecondaryCaptureObjectIsMRImageStorage( r ) ):
59         # Special handling of the spacing:
60         # GDCM 1.2.0 would not rewrite correctly DICOM Object and would always set them as 'Secondary Capture
        Image Storage'
61         # while we would rather have 'MR Image Storage'
62         gdcM.ImageHelper.SetForcePixelSpacing( True )
63         mrspacing = gdcM.ImageHelper.GetSpacingValue( r.GetFile() )
64         # TODO: I cannot do simply the following:
65         #image.SetSpacing( mrspacing )
66         image.SetSpacing(0, mrspacing[0] )
67         image.SetSpacing(1, mrspacing[1] )
68         image.SetSpacing(2, mrspacing[2] )
69         gdcM.ImageHelper.SetForceRescaleInterceptSlope( True )
70         ris = gdcM.ImageHelper.GetRescaleInterceptSlopeValue( r.GetFile() )
71         image.SetIntercept( ris[0] )
72         image.SetSlope( ris[1] )
73
74     outfilename = sys.argv[2]
75     w = gdcM.ImageWriter()
76     w.SetFileName( outfilename )
77     w.SetFile( r.GetFile() )
78     w.SetImage( image )
79     if not w.Write():
80         sys.exit(1)
81
82     sys.exit(0)

```

## 12.132 ReadAndDumpDICOMDIR.py

```

1
23
24
25
26 import sys
27 import gdcM
28
29 if __name__ == "__main__":
30     # Check arguments
31     if (len(sys.argv) < 2):
32         # No filename passed
33         print "No input filename found"
34         quit()
35
36     filename = sys.argv[1]
37
38
39     # Read file
40     reader = gdcM.Reader()
41     reader.SetFileName(filename)
42     if (not reader.Read()):
43         print "Unable to read %s" % (filename)
44         quit()
45
46     file = reader.GetFile()
47
48     # Retrieve header information
49     fileMetaInformation = file.GetHeader()
50     print fileMetaInformation
51

```

```

52     # Retrieve data set
53     dataSet = file.GetDataSet()
54     #print dataSet
55
56     # Check media storage
57     mediaStorage = gdcm.MediaStorage()
58     mediaStorage.SetFromFile(file)
59     if (gdcm.MediaStorage.GetMSType(str(mediaStorage)) != gdcm.MediaStorage.MediaStorageDirectoryStorage):
60         # File is not a DICOMDIR
61         print "This file is not a DICOMDIR (Media storage type: %s)" % (str(mediaStorage))
62         quit()
63
64     # Check Media Storage SOP Class
65     if (fileMetaInformation.FindDataElement(gdcm.Tag(0x0002, 0x0002))):
66         sopClassUid = str(fileMetaInformation.GetDataElement(gdcm.Tag(0x0002, 0x0002)).GetValue())
67         # Check SOP UID
68         if (sopClassUid != "1.2.840.10008.1.3.10"):
69             # File is not a DICOMDIR
70             print "This file is not a DICOMDIR"
71     else:
72         # Not present
73         print "Media Storage SOP Class not present"
74         quit()
75
76     # Iterate through the DICOMDIR data set
77     iterator = dataSet.GetDES().begin()
78     while (not iterator.equal(dataSet.GetDES().end())):
79         dataElement = iterator.next()
80
81         # Check the element tag
82         if (dataElement.GetTag() == gdcm.Tag(0x004, 0x1220)):
83             # The 'Directory Record Sequence' element
84             sequence = dataElement.GetValueAsSQ()
85
86             # Loop through the sequence items
87             itemNr = 1
88             while (itemNr < sequence.GetNumberOfItems()):
89                 item = sequence.GetItem(itemNr)
90
91                 # Check the element tag
92                 if (item.FindDataElement(gdcm.Tag(0x0004, 0x1430))):
93                     # The 'Directory Record Type' element
94                     value = str(item.GetDataElement(gdcm.Tag(0x0004, 0x1430)).GetValue())
95
96                     # PATIENT
97                     while (value.strip() == "PATIENT"):
98                         print value.strip()
99                         # Print patient name
100                        if (item.FindDataElement(gdcm.Tag(0x0010, 0x0010))):
101                            value = str(item.GetDataElement(gdcm.Tag(0x0010, 0x0010)).GetValue())
102                            print value
103
104                        # Print patient ID
105                        if (item.FindDataElement(gdcm.Tag(0x0010, 0x0020))):
106                            value = str(item.GetDataElement(gdcm.Tag(0x0010, 0x0020)).GetValue())
107                            print value
108
109                        # Next
110                        itemNr = itemNr + 1
111                        item = sequence.GetItem(itemNr)
112                        if (item.FindDataElement(gdcm.Tag(0x0004, 0x1430))):
113                            value = str(item.GetDataElement(gdcm.Tag(0x0004, 0x1430)).GetValue())
114
115                        # STUDY
116                        while (value.strip() == "STUDY"):
117                            print value.strip()
118
119                            # Print study UID
120                            if (item.FindDataElement(gdcm.Tag(0x0020, 0x000d))):
121                                value = str(item.GetDataElement(gdcm.Tag(0x0020, 0x000d)).GetValue())
122                                print value
123
124                            # Print study date
125                            if (item.FindDataElement(gdcm.Tag(0x0008, 0x0020))):
126                                value = str(item.GetDataElement(gdcm.Tag(0x0008, 0x0020)).GetValue())
127                                print value
128
129                            # Print study description
130                            if (item.FindDataElement(gdcm.Tag(0x0008, 0x1030))):
131                                value = str(item.GetDataElement(gdcm.Tag(0x0008, 0x1030)).GetValue())
132                                print value

```

```

133
134
135     # Next
136     itemNr = itemNr + 1
137     item = sequence.GetItem(itemNr)
138     if (item.FindDataElement(gdcm.Tag(0x0004, 0x1430))):
139         value = str(item.GetDataElement(gdcm.Tag(0x0004, 0x1430)).GetValue())
140
141     # SERIES
142     while (value.strip() == "SERIES"):
143         print value.strip()
144
145         # Print series UID
146         if (item.FindDataElement(gdcm.Tag(0x0020, 0x000e))):
147             value = str(item.GetDataElement(gdcm.Tag(0x0020, 0x000e)).GetValue())
148             print value
149
150         # Print series modality
151         if (item.FindDataElement(gdcm.Tag(0x0008, 0x0060))):
152             value = str(item.GetDataElement(gdcm.Tag(0x0008, 0x0060)).GetValue())
153             print "Modality"
154             print value
155
156         # Print series description
157         if (item.FindDataElement(gdcm.Tag(0x0008, 0x103e))):
158             value = str(item.GetDataElement(gdcm.Tag(0x0008, 0x103e)).GetValue())
159             print "Description"
160             print value
161
162         # Next
163         itemNr = itemNr + 1
164         item = sequence.GetItem(itemNr)
165         if (item.FindDataElement(gdcm.Tag(0x0004, 0x1430))):
166             value = str(item.GetDataElement(gdcm.Tag(0x0004, 0x1430)).GetValue())
167
168         # IMAGE
169         while (value.strip() == "IMAGE"):
170             print value.strip()
171
172             # Print image UID
173             if (item.FindDataElement(gdcm.Tag(0x0004, 0x1511))):
174                 value = str(item.GetDataElement(gdcm.Tag(0x0004,
175                 Ox1511)).GetValue())
176
177                 print value
178
179             # Next
180             if (itemNr < sequence.GetNumberOfItems()):
181                 itemNr = itemNr + 1
182             else:
183                 break
184
185             item = sequence.GetItem(itemNr)
186             if (item.FindDataElement(gdcm.Tag(0x0004, 0x1430))):
187                 value = str(item.GetDataElement(gdcm.Tag(0x0004,
188                 Ox1430)).GetValue())
189
190         # Next
191         itemNr = itemNr + 1

```

## 12.133 RemovePrivateTags.py

```

1
14
15 """
16 Usage:
17
18 python RemovePrivateTags.py input.dcm output.dcm
19 """
20
21 import sys
22 import gdcm
23
24
25 if __name__ == "__main__":
26
27     file1 = sys.argv[1]
28     file2 = sys.argv[2]
29

```

```

30 # Instantiate the reader.
31 r = gdcM.Reader()
32 r.SetFileName( file1 )
33 if not r.Read():
34     sys.exit(1)
35
36 # Remove private tags
37 ano = gdcM.Anonymizer()
38 ano.SetFile( r.GetFile() )
39 if not ano.RemovePrivateTags():
40     sys.exit(1)
41
42 # Write DICOM file
43 w = gdcM.Writer()
44 w.SetFile( ano.GetFile() )
45 #w.CheckFileMetaInformationOff() # Do not attempt to check meta header
46 w.SetFileName( file2 )
47 if not w.Write():
48     sys.exit(1)
49
50 # It is usually a good idea to exit the script with an error, as gdcM does not remove partial (incorrect)
    DICOM file
51 # (application level)

```

## 12.134 ScanDirectory.py

```

1
14
15 import gdcM
16 import sys,os
17
18 class ProgressWatcher(gdcM.SimpleSubjectWatcher):
19     def ShowProgress(self, sender, event):
20         pe = gdcM.ProgressEvent.Cast(event)
21         print pe.GetProgress()
22     def EndFilter(self):
23         print "Yay ! I am done"
24
25 if __name__ == "__main__":
26     directory = sys.argv[1]
27
28     # Define the set of tags we are interested in
29     t1 = gdcM.Tag(0x8,0x8);
30     t2 = gdcM.Tag(0x10,0x10);
31
32     # Iterate over directory
33     d = gdcM.Directory();
34     nfiles = d.Load( directory );
35     if(nfiles == 0): sys.exit(1);
36     # System.Console.WriteLine( "Files:\n" + d.toString() );
37
38     filenames = d.GetFilenames()
39
40     # Get rid of any Warning while parsing the DICOM files
41     gdcM.Trace.WarningOff()
42
43     # instantiate Scanner:
44     sp = gdcM.Scanner.New();
45     s = sp.__ref__();
46     w = ProgressWatcher(s, 'Watcher')
47
48     s.AddTag( t1 );
49     s.AddTag( t2 );
50     b = s.Scan( filenames );
51     if(not b): sys.exit(1);
52
53     print "success" ;
54     #print s
55
56     pttv = gdcM.PythonTagToValue( s.GetMapping( filenames[1] ) )
57     pttv.Start()
58     # iterate until the end:
59     while( not pttv.IsAtEnd() ):
60         # get current value for tag and associated value:
61         # if tag was not found, then it was simply not added to the internal std::map
62         # Warning value can be None
63         tag = pttv.GetCurrentTag()

```



```

64     value = pttv.GetCurrentValue()
65     print tag,"->",value
66     # increment iterator
67     pttv.Next()
68
69     sys.exit(0)

```

## 12.135 SortImage.py

```

1
14
15 """
16 Usage:
17
18 python SortImage.py dirname
19 """
20
21 import gdcM
22 import sys
23
24 def PrintProgress(object, event):
25     assert event == "ProgressEvent"
26     print "Progress:", object.GetProgress()
27
28 def MySort(ds1, ds2):
29     # compare ds1
30     return False
31
32 if __name__ == "__main__":
33
34     dirname = sys.argv[1]
35     d = gdcM.Directory()
36     d.Load( dirname )
37
38     print d
39
40     sorter = gdcM.Sorter()
41     sorter.SetSortFunction( MySort )
42     #sorter.AddObserver( "ProgressEvent", PrintProgress )
43     sorter.Sort( d.GetFileNames() )
44
45     print "Sorter:"
46     print sorter

```

## 12.136 WriteBuffer.py

```

1
14
15 """
16 Usage:
17
18 http://chuckhahm.com/Ischem/Zurich/XX_0134
19
20 (2005,1132) SQ (Sequence with undefined length #=8) # u/1, 1 Unknown Tag & Data
21 (fffe,e000) na (Item with undefined length #=9) # u/1, 1 Item
22 (2005,0011) LO [Philips MR Imaging DD 002] # 26, 1 PrivateCreator
23 (2005,1137) PN [PDF_CONTROL_GEN_PARS] # 20, 1 Unknown Tag & Data
24 (2005,1138) PN (no value available) # 0, 0 Unknown Tag & Data
25 (2005,1139) PN [IEEE_PDF] # 8, 1 Unknown Tag & Data
26 (2005,1140) PN (no value available) # 0, 0 Unknown Tag & Data
27 (2005,1141) PN (no value available) # 0, 0 Unknown Tag & Data
28 (2005,1143) SL 3103 # 4, 1 Unknown Tag & Data
29 (2005,1144) OW 0566\0000\013b\0000\0a4a\0000\000e\0000\0a7a\0000\0195\0000\0008... # 3104, 1 Unknown Tag
    & Data
30 (2005,1147) CS [Y] # 2, 1 Unknown Tag & Data
31 (fffe,e00d) na (ItemDelimitationItem) # 0, 0 ItemDelimitationItem
32 (fffe,e000) na (Item with undefined length #=9) # u/1, 1 Item
33 (2005,0011) LO [Philips MR Imaging DD 002] # 26, 1 PrivateCreator
34 (2005,1137) PN [PDF_CONTROL_PREP_PARS] # 22, 1 Unknown Tag & Data
35 (2005,1138) PN (no value available) # 0, 0 Unknown Tag & Data
36 (2005,1139) PN [IEEE_PDF] # 8, 1 Unknown Tag & Data
37 (2005,1140) PN (no value available) # 0, 0 Unknown Tag & Data
38 (2005,1141) PN (no value available) # 0, 0 Unknown Tag & Data

```

```

39     (2005,1143) SL 7934 # 4, 1 Unknown Tag & Data
40     (2005,1144) OW 19b6\0000\005f\0000\1b2a\0000\00f3\0000\1eee\0000\0000\0000\0008... # 7934, 1 Unknown Tag
    & Data
41     (2005,1147) CS [Y] # 2, 1 Unknown Tag & Data
42     (ffff,e00d) na (ItemDelimitationItem) # 0, 0 ItemDelimitationItem
43 ...
44 ""
45
46 import sys
47 import gdcm
48
49 if __name__ == "__main__":
50
51     file1 = sys.argv[1]
52     file2 = sys.argv[2]
53
54     r = gdcm.Reader()
55     r.SetFileName( file1 )
56     if not r.Read():
57         sys.exit(1)
58
59     fg = gdcm.FileNameGenerator()
60     f = r.GetFile()
61     ds = f.GetDataSet()
62     tsis = gdcm.Tag(0x2005,0x1132) #
63     if ds.FindDataElement( tsis ):
64         sis = ds.GetDataElement( tsis )
65         #sqsis = sis.GetSequenceOfItems()
66         # GetValueAsSQ handle more cases
67         sqsis = sis.GetValueAsSQ()
68         if sqsis.GetNumberOfItems():
69             nitems = sqsis.GetNumberOfItems();
70             fg.SetNumberOfFileNames( nitems )
71             fg.SetPrefix( file2 )
72             if not fg.Generate():
73                 print "problem"
74                 sys.exit(1)
75         for i in range(0,nitems):
76             item1 = sqsis.GetItem(i+1) # Item start at 1
77             nestedds = item1.GetNestedDataSet()
78             tprcs = gdcm.Tag(0x2005,0x1144) #
79             if nestedds.FindDataElement( tprcs ):
80                 prcs = nestedds.GetDataElement( tprcs )
81                 bv = prcs.GetByteValue()
82                 print bv
83                 f = open( fg.GetFilename(i) , "w" )
84                 f.write( bv.WriteBuffer() )

```

## 12.137 HelloActiviz.cs

```

/*=====
Program: GDCM (Grassroots DICOM). A DICOM library

Copyright (c) 2006-2011 Mathieu Malaterre
All rights reserved.
See Copyright.txt or http://gdcm.sourceforge.net/Copyright.html for details.

This software is distributed WITHOUT ANY WARRANTY; without even
the implied warranty of MERCHANTABILITY or FITNESS FOR A PARTICULAR
PURPOSE. See the above copyright notice for more information.

=====*/
using vtkgdcm;
using Kitware.VTK;
using System;
using System.Runtime.InteropServices;
/*
 * This example shows how vtkgdcm can be connected to Kitware.VTK Activiz product.
 * Three (3) arguments are required:
 * 1. Input DICOM file (SWIG)
 * 2. Temporary PNG (intermediate) file (Activiz)
 * 3. Final DICOM file (SWIG)
 *
 * $ export MONO_PATH=/usr/lib/cli/Activiz.NET:/usr/lib/cli/Kitware.mummy.Runtime-1.0
 * $ mono ./bin/HelloActiviz.exe ~/Creatis/gdcmData/test.acr out.png toto.dcm
 */

```

```

* Footnote:
* this test originally used vtkBMPWriter / vtkBMPReader combination to store intermediate
* image file, but BMP file are 24bits by default. Instead use PNG format which supports seems
* to be closer to what was expected in this simple test.
*/
public class HelloActiviz
{
    // Does not work with Activiz.NET-5.4.0.455-Linux-x86_64-Personal
    /*
    static void ConnectSWIGToActiviz(Kitware.VTK.vtkImageExport imgin, Kitware.VTK.vtkImageImport imgout)
    {
        imgout.SetUpdateInformationCallback(imgin.GetUpdateInformationCallback());
        imgout.SetPipelineModifiedCallback(imgin.GetPipelineModifiedCallback());
        imgout.SetWholeExtentCallback(imgin.GetWholeExtentCallback());
        imgout.SetSpacingCallback(imgin.GetSpacingCallback());
        imgout.SetOriginCallback(imgin.GetOriginCallback());
        imgout.SetScalarTypeCallback(imgin.GetScalarTypeCallback());
        imgout.SetNumberOfComponentsCallback(imgin.GetNumberOfComponentsCallback());
        imgout.SetPropagateUpdateExtentCallback(imgin.GetPropagateUpdateExtentCallback());
        imgout.SetUpdateDataCallback(imgin.GetUpdateDataCallback());
        imgout.SetDataExtentCallback(imgin.GetDataExtentCallback());
        imgout.SetBufferPointerCallback(imgin.GetBufferPointerCallback());
        imgout.SetCallbackUserData(imgin.GetCallbackUserData());
    }
    */
    static Kitware.VTK.vtkImageData ConnectSWIGToActiviz(vtkgdc.vtkImageData imgin)
    {
        HandleRef rawCppThis = imgin.GetCppThis();
        Kitware.VTK.vtkImageData imgout = new Kitware.VTK.vtkImageData( rawCppThis.Handle, false, false);
        return imgout;
    }
    static vtkgdc.vtkImageData ConnectActivizToSWIG(Kitware.VTK.vtkImageData imgin)
    {
        HandleRef rawCppThis = imgin.GetCppThis();
        vtkgdc.vtkImageData imgout = new vtkgdc.vtkImageData( rawCppThis );
        return imgout;
    }
    public static int Main(string[] args)
    {
        string filename = args[0];
        string outfilename = args[1];
        // Step 1. Test SWIG -> Activiz
        vtkGDCMImageReader reader = vtkGDCMImageReader.New();
        reader.SetFileName( filename );
        //reader.Update(); // DO NOT call Update to check pipeline execution
        Kitware.VTK.vtkImageData imgout = ConnectSWIGToActiviz(reader.GetOutput());
        System.Console.WriteLine( imgout.ToString() ); // not initialized as expected
        vtkPNGWriter writer = new vtkPNGWriter();
        writer.SetInput( imgout );
        writer.SetFileName( outfilename );
        writer.Write();
        // Step 2. Test Activiz -> SWIG
        vtkPNGReader bmpreader = new vtkPNGReader();
        bmpreader.SetFileName( outfilename );
        //bmpreader.Update(); // DO NOT update to check pipeline execution
        System.Console.WriteLine( bmpreader.GetOutput().ToString() ); // not initialized as expected
        vtkgdc.vtkImageData imgout2 = ConnectActivizToSWIG(bmpreader.GetOutput());
        System.Console.WriteLine( imgout2.ToString() ); // not initialized as expected
        Kitware.VTK.vtkMedicalImageProperties prop = new Kitware.VTK.vtkMedicalImageProperties();
        prop.SetModality( "MR" );
        string outfilename2 = args[2];
        vtkGDCMImageWriter writer2 = vtkGDCMImageWriter.New();
        writer2.SetMedicalImageProperties( prop.CastToActiviz() );
        writer2.SetFileName( outfilename2 );
        writer2.SetInput( imgout2 );
        writer2.Write();
        return 0;
    }
}

```

## 12.138 HelloActiviz2.cs

```

/*=====
Program: GDCM (Grassroots DICOM). A DICOM library

Copyright (c) 2006-2011 Mathieu Malaterre

```

All rights reserved.  
See Copyright.txt or <http://gdcm.sourceforge.net/Copyright.html> for details.

This software is distributed WITHOUT ANY WARRANTY; without even the implied warranty of MERCHANTABILITY or FITNESS FOR A PARTICULAR PURPOSE. See the above copyright notice for more information.

```

=====*/
using Kitware.VTK;
using Kitware.VTK.GDCM;
/*
 * Usage:
 * $ export MONO_PATH=/usr/lib/cli/Activiz.NET:/usr/lib/cli/Kitware.mummy.Runtime-1.0
 * $ mono ./bin/HelloActiviz2.exe gdcmData/test.acr bla.png bla2.dcm
 */
/*
 * From the outside view, no-one can detect that object pass to/from
 * vtkGDCMImageWriter/vtkGDCMImageReader are not Activiz object.
 *
 * TODO: Test Command/Observer
 */
public class HelloActiviz2
{
    public static int Main(string[] args)
    {
        string filename = args[0];
        string outfilename = args[1];
        string outfilename2 = args[2];
        vtkGDCMImageReader reader = new Kitware.VTK.GDCM.vtkGDCMImageReader();
        reader.SetFileName( filename );
        // When calling multiple times creation of C# object from the same C++ object it triggers a:
        //error: potential refcounting error: Duplicate rawCppThis - weak reference that is still alive. Attempting to
        //    add '0x00b2dc10' again.
        //    Allowing new wrapped object to take over table key...
        //    Original object should *not* have been destroyed while we still had it in our table without notifying
        //    us...
        //reader.GetOutput();
        //reader.GetOutput();
        System.Console.WriteLine( reader.ToString() ); // Test the ToString compat with Activiz
        vtkGDCMImageWriter writer = new vtkGDCMImageWriter();
        writer.SetInput( reader.GetOutput() );
        writer.SetFileName( outfilename2 );
        writer.Write();
        System.Console.WriteLine( reader.GetOutput().ToString() ); // Test the ToString compat with Activiz
        System.Console.WriteLine( writer.ToString() ); // Test the ToString compat with Activiz
        vtkPNGWriter pngwriter = new vtkPNGWriter();
        pngwriter.SetInput( reader.GetOutput() );
        pngwriter.SetFileName( outfilename );
        pngwriter.Write();
        // at that point the .Write() should have triggered an Update() on the reader:
        if( reader.GetImageFormat() == vtkgdcm.VTK_LUMINANCE ) // MONOCHROME2
        {
            System.Console.WriteLine( "Image is MONOCHROME2" ); //
        }
        vtkPNGReader bmpreader = new vtkPNGReader();
        bmpreader.SetFileName( outfilename );
        vtkMedicalImageProperties prop = new vtkMedicalImageProperties();
        prop.SetModality( "MR" );
        vtkMatrix4x4 dircos = reader.GetDirectionCosines();
        dircos.Invert();
        vtkGDCMImageWriter writer2 = new vtkGDCMImageWriter();
        writer2.SetFileName( outfilename2 );
        writer2.SetDirectionCosines( dircos );
        writer2.SetMedicalImageProperties( prop );
        writer2.SetInput( bmpreader.GetOutput() );
        writer2.Write();
        return 0;
    }
}

```

## 12.139 HelloActiviz3.cs

```

/*=====
Program: GDCM (Grassroots DICOM). A DICOM library

Copyright (c) 2006-2011 Mathieu Malaterre

```

All rights reserved.  
See Copyright.txt or <http://gdcm.sourceforge.net/Copyright.html> for details.

This software is distributed WITHOUT ANY WARRANTY; without even  
the implied warranty of MERCHANTABILITY or FITNESS FOR A PARTICULAR  
PURPOSE. See the above copyright notice for more information.

```

=====*/
using Kitware.VTK;
using Kitware.VTK.GDCM;
/*
 * $ export MONO_PATH=/usr/lib/cli/Activiz.NET:/usr/lib/cli/Kitware.mummy.Runtime-1.0
 * $ mono ./bin/HelloActiviz3.exe ~/Creatis/gdcmData/test.acr
 */
public class HelloActiviz3
{
    public static int Main(string[] args)
    {
        string filename = args[0];
        vtkGDCMImageReader reader = vtkGDCMImageReader.New();
        vtkStringArray array = vtkStringArray.New();
        array.InsertNextValue(filename);
        reader.SetFileNames(array);
        reader.Update();
        //System.Console.Write(reader.GetOutput());
        vtkRenderWindowInteractor iren = vtkRenderWindowInteractor.New();
        vtkImageViewer2 viewer = vtkImageViewer2.New();
        viewer.SetInput(reader.GetOutput());
        viewer.SetupInteractor(iren);
        viewer.SetSize(600, 600);
        viewer.Render();
        iren.Initialize();
        iren.Start();
        return 0;
    }
}

```

## 12.140 HelloActiviz4.cs

```

/*=====
Program: GDCM (Grassroots DICOM). A DICOM library

Copyright (c) 2006-2011 Mathieu Malaterre
All rights reserved.
See Copyright.txt or http://gdcm.sourceforge.net/Copyright.html for details.

This software is distributed WITHOUT ANY WARRANTY; without even
the implied warranty of MERCHANTABILITY or FITNESS FOR A PARTICULAR
PURPOSE. See the above copyright notice for more information.

=====*/
using Kitware.VTK;
using Kitware.VTK.GDCM;
/*
 * $ export MONO_PATH=/usr/lib/cli/Activiz.NET:/usr/lib/cli/Kitware.mummy.Runtime-1.0
 * $ mono ./bin/HelloActiviz4.exe ~/Creatis/gdcmData/test.acr
 */
public class HelloActiviz4
{
    public static int Main(string[] args)
    {
        string filename = args[0];
        vtkGDCMImageReader reader = new vtkGDCMImageReader();
        vtkStringArray array = vtkStringArray.New();
        array.InsertNextValue(filename);
        reader.SetFileNames(array);
        reader.Update();
        //System.Console.Write(reader.GetOutput());
        vtkRenderWindowInteractor iren = vtkRenderWindowInteractor.New();
        vtkImageViewer viewer = vtkImageViewer.New();
        viewer.SetInput(reader.GetOutput());
        viewer.SetupInteractor(iren);
        viewer.SetSize(600, 600);
        viewer.Render();
        iren.Initialize();
        iren.Start();
    }
}

```

```

    return 0;
}
}

```

## 12.141 HelloActiviz5.cs

```

/*=====
Program: GDCM (Grassroots DICOM). A DICOM library

Copyright (c) 2006-2011 Mathieu Malaterre
All rights reserved.
See Copyright.txt or http://gdcm.sourceforge.net/Copyright.html for details.

This software is distributed WITHOUT ANY WARRANTY; without even
the implied warranty of MERCHANTABILITY or FITNESS FOR A PARTICULAR
PURPOSE. See the above copyright notice for more information.

=====*/
using Kitware.VTK;
using Kitware.VTK.GDCM;
// The command line arguments are:
// -I      => run in interactive mode; unless this is used, the program will
//         not allow interaction and exit
// -D <path> => path to the data; the data should be in <path>/Data/
/*
 * $ export MONO_PATH=/usr/lib/cli/Activiz.NET:/usr/lib/cli/Kitware.mummy.Runtime-1.0
 * $ mono ./bin/HelloActiviz5.exe -I
 */
public class HelloActiviz5
{
    public static int Main(string[] args)
    {
        vtkTesting testHelper = vtkTesting.New();
        for ( int cc = 0; cc < args.Length; cc++ )
        {
            //testHelper.AddArguments(argc, const_cast<const char **>(argv));
            //System.Console.Write( "args: " + args[cc] + "\n" );
            testHelper.AddArgument( args[cc] );
        }
        if ( testHelper.IsFlagSpecified("-D") != 0 )
        {
            string VTK_DATA_ROOT = vtkGDCMTesting.GetVTKDataRoot();
            if( VTK_DATA_ROOT != null )
            {
                //System.Console.Write( "VTK_DATA_ROOT: " + VTK_DATA_ROOT + "\n" );
                testHelper.SetDataRoot(VTK_DATA_ROOT);
                testHelper.AddArgument("-D");
                testHelper.AddArgument(VTK_DATA_ROOT);
            }
        }
        string dataRoot = testHelper.GetDataRoot();
        string filename = dataRoot;
        filename += "/Data/mr.001";
        vtkDirectory dir = vtkDirectory.New();
        if( dir.FileIsDirectory( dataRoot ) == 0 )
        {
            filename = vtkGDCMTesting.GetGDCMDataRoot() + "/test.acr";
        }
        //System.Console.Write( "dataRoot: " + dataRoot + "\n" );
        System.Console.Write( "filename being used is: " + filename + "\n" );
        vtkGDCMImageReader reader = vtkGDCMImageReader.New();
        vtkStringArray array = vtkStringArray.New();
        array.InsertNextValue(filename);
        reader.SetFileNames(array);
        reader.Update();
        System.Console.Write(reader.GetOutput());
        vtkRenderWindowInteractor iren = vtkRenderWindowInteractor.New();
        vtkRenderer ren1 = vtkRenderer.New();
        vtkRenderWindow renWin = vtkRenderWindow.New();
        renWin.AddRenderer(ren1);
        vtkImageActor actor = vtkImageActor.New();
        vtkImageMapToWindowLevelColors coronalColors = vtkImageMapToWindowLevelColors.New();
        coronalColors.SetInput(reader.GetOutput());
        actor.SetInput(coronalColors.GetOutput());
        ren1.AddActor(actor);
        iren.SetRenderWindow(renWin);
    }
}

```

```

    iren.Initialize();
    renWin.Render();
    int retVal = testHelper.IsInteractiveModeSpecified();
    if( retVal != 0 )
    {
        iren.Start();
    }
    return 0;
}
}

```

## 12.142 HelloVTKWorld.cs

```

/*=====
Program: GDCM (Grassroots DICOM). A DICOM library

Copyright (c) 2006-2011 Mathieu Malaterre
All rights reserved.
See Copyright.txt or http://gdcmlib.sourceforge.net/Copyright.html for details.

This software is distributed WITHOUT ANY WARRANTY; without even
the implied warranty of MERCHANTABILITY or FITNESS FOR A PARTICULAR
PURPOSE. See the above copyright notice for more information.

=====*/
using vtkgdcmlib;
/*
 * This test only test the SWIG/VTK part, you do not need Activiz
 */
public class HelloVTKWorld
{
    public static int Main(string[] args)
    {
        string filename = args[0];
        vtkGDCMImageReader reader = vtkGDCMImageReader.New();
        reader.SetFileName( filename );
        reader.Update();
        vtkMedicalImageProperties prop = reader.GetMedicalImageProperties();
        System.Console.WriteLine( prop.GetPatientName() ); //
        if( reader.GetImageFormat() == vtkgdcmlib.VTK_LUMINANCE ) // MONOCHROME2
        {
            System.Console.WriteLine( "Image is MONOCHROME2" ); //
        }
        // Just for fun, invert the direction cosines, output should reflect that:
        vtkMatrix4x4 dircos = reader.GetDirectionCosines();
        dircos.Invert();
        string outfilename = args[1];
        vtkGDCMImageWriter writer = vtkGDCMImageWriter.New();
        writer.SetMedicalImageProperties( reader.GetMedicalImageProperties() );
        writer.SetDirectionCosines( dircos );
        writer.SetShift( reader.GetShift() );
        writer.SetScale( reader.GetScale() );
        writer.SetImageFormat( reader.GetImageFormat() );
        writer.SetFileName( outfilename );
        writer.SetInputConnection( reader.GetOutputPort() );
        writer.Write();
        return 0;
    }
}

```

## 12.143 HelloVTKWorld2.cs

```

/*=====
Program: GDCM (Grassroots DICOM). A DICOM library

Copyright (c) 2006-2011 Mathieu Malaterre
All rights reserved.
See Copyright.txt or http://gdcmlib.sourceforge.net/Copyright.html for details.

This software is distributed WITHOUT ANY WARRANTY; without even
the implied warranty of MERCHANTABILITY or FITNESS FOR A PARTICULAR
PURPOSE. See the above copyright notice for more information.

=====*/

```

```

    PURPOSE. See the above copyright notice for more information.
=====*/
using vtkgdcm;
/*
 * This test only test the SWIG/VTK part, you do not need Activiz
 */
public class HelloVTKWorld2
{
    public static int Main(string[] args)
    {
        string VTK_DATA_ROOT = vtkGDCMTesting.GetVTKDataRoot();
        vtkVolumel6Reader reader = vtkVolumel6Reader.New();
        reader.SetDataDimensions(64, 64);
        reader.SetDataByteOrderToLittleEndian();
        reader.SetFilePrefix(VTK_DATA_ROOT + "/Data/headsq/quarter");
        reader.SetImageRange(1, 93);
        reader.SetDataSpacing(3.2, 3.2, 1.5);
        vtkImageCast cast = vtkImageCast.New();
        cast.SetInputConnection( reader.GetOutputPort() );
        cast.SetOutputScalarTypeToUnsignedChar();
        // By default this is creating a Multiframe Grayscale Word Secondary Capture Image Storage
        vtkGDCMImageWriter writer = vtkGDCMImageWriter.New();
        writer.SetFileName( "headsq.dcm" );
        writer.SetInputConnection( reader.GetOutputPort() );
        // cast -> Multiframe Grayscale Byte Secondary Capture Image Storage
        // writer.SetInputConnection( cast.GetOutputPort() );
        writer.SetFileDimensionality( 3 );
        writer.Write();
        return 0;
    }
}

```

## 12.144 MetaImageMD5Activiz.cs

```

/*=====
Program: GDCM (Grassroots DICOM). A DICOM library

Copyright (c) 2006-2011 Mathieu Malaterre
All rights reserved.
See Copyright.txt or http://gdcm.sourceforge.net/Copyright.html for details.

This software is distributed WITHOUT ANY WARRANTY; without even
the implied warranty of MERCHANTABILITY or FITNESS FOR A PARTICULAR
PURPOSE. See the above copyright notice for more information.
=====*/
using Kitware.VTK;
using Kitware.VTK.GDCM;
using gdcm;
/*
 * $ export MONO_PATH=/usr/lib/cli/Activiz.NET:/usr/lib/cli/Kitware.mummy.Runtime-1.0
 * $ mono ./bin/MetaImageMD5Activiz.exe gdcmData/012345.002.050.dcm
 */
public class MetaImageMD5Activiz
{
    public static int ProcessOneMHDMD5(string filename)
    {
        vtkGDCMImageReader reader = vtkGDCMImageReader.New();
        reader.FileLowerLeftOn();
        reader.DebugOff();
        int canread = reader.CanReadFile( filename );
        if( canread == 0 )
        {
            string refms = gdcm.Testing.GetMediaStorageFromFile(filename);
            if( gdcm.MediaStorage.IsImage( gdcm.MediaStorage.GetMSType(refms) ) )
            {
                System.Console.Write( "Problem with file: " + filename + "\n" );
                return 1;
            }
            // not an image
            return 0;
        }
        reader.SetFileName( filename );
        reader.Update();
        // System.Console.Write(reader.GetOutput());
    }
}

```



```

vtkMetaImageWriter writer = vtkMetaImageWriter.New();
writer.SetCompression( false );
writer.SetInput( reader.GetOutput() );
string subdir = "MetaImageMD5Activiz";
string tmpdir = gdcm.Testing.GetTempDirectory( subdir );
if( !gdcm.PosixEmulation.FileIsDirectory( tmpdir ) )
{
    gdcm.PosixEmulation.MakeDirectory( tmpdir );
}
string mhdfilename = gdcm.Testing.GetTempFilename( filename, subdir );
string rawfile = mhdfilename;
mhdfilename += ".mhd";
rawfile += ".raw";
writer.SetFileName( mhdfilename );
writer.Write();
string digestmhd = gdcm.Testing.ComputeFileMD5( mhdfilename );
string digestraw = gdcm.Testing.ComputeFileMD5( rawfile );
string mhhref = vtkGDCMTesting.GetMHDMD5FromFile( filename );
string rawref = vtkGDCMTesting.GetRAWMD5FromFile( filename );
if( mhhref != digestmhd )
{
    System.Console.WriteLine( "Problem with mhd file: " + filename + "\n" );
    System.Console.WriteLine( digestmhd );
    System.Console.WriteLine( "\n" );
    System.Console.WriteLine( mhhref );
    System.Console.WriteLine( "\n" );
    return 1;
}
if( rawref != digestraw )
{
    System.Console.WriteLine( "Problem with raw file: " + filename + "\n" );
    System.Console.WriteLine( digestraw );
    System.Console.WriteLine( "\n" );
    System.Console.WriteLine( rawref );
    System.Console.WriteLine( "\n" );
    return 1;
}
return 0;
}
public static int Main( string[] args )
{
    if ( args.Length == 1 )
    {
        string filename = args[0];
        return ProcessOneMHDMD5( filename );
    }
    // Loop over all gdcmData
    gdcm.Trace.DebugOff();
    gdcm.Trace.WarningOff();
    gdcm.Trace.ErrorOff();
    uint n = gdcm.Testing.GetNumberOfFileNames();
    int ret = 0;
    for( uint i = 0; i < n; ++i )
    {
        string filename = gdcm.Testing.GetFileName( i );
        ret += ProcessOneMHDMD5( filename );
    }
    return ret;
}
}

```

## 12.145 RefCounting.cs

```

/*=====
Program: GDCM (Grassroots DICOM). A DICOM library

Copyright (c) 2006-2011 Mathieu Malaterre
All rights reserved.
See Copyright.txt or http://gdcm.sourceforge.net/Copyright.html for details.

This software is distributed WITHOUT ANY WARRANTY; without even
the implied warranty of MERCHANTABILITY or FITNESS FOR A PARTICULAR
PURPOSE. See the above copyright notice for more information.

=====*/
using Kitware.VTK;

```

```

using Kitware.VTK.GDCM;
/*
 * this is not so much an example but simply a test to make sure ctor / dstor work as expected
 * and call the ::New and ->Delete() of VTK style.
 */
public class RefCounting
{
    public static int Main(string[] args)
    {
        vtkGDCMTesting testing1 = vtkGDCMTesting.New();
        vtkGDCMTesting testing2 = new vtkGDCMTesting(); // just in case people do not read STYLE documentation
        vtkGDCMImageReader reader1 = vtkGDCMImageReader.New();
        vtkGDCMImageReader reader2 = new vtkGDCMImageReader();
        vtkGDCMImageWriter writer1 = vtkGDCMImageWriter.New();
        vtkGDCMImageWriter writer2 = new vtkGDCMImageWriter();
        using (vtkGDCMTesting testing3 = new vtkGDCMTesting())
        {
            System.Console.WriteLine( "GetReferenceCount: " + testing1.GetReferenceCount() + "\n");
            System.Console.WriteLine( "GetReferenceCount: " + testing2.GetReferenceCount() + "\n");
            System.Console.WriteLine( "GetReferenceCount: " + testing3.GetReferenceCount() + "\n");
        }
        using (vtkGDCMImageReader reader3 = new vtkGDCMImageReader())
        {
            System.Console.WriteLine( "GetReferenceCount: " + reader3.GetReferenceCount() + "\n");
        }
        using (vtkGDCMImageWriter writer3 = vtkGDCMImageWriter.New())
        {
            System.Console.WriteLine( "GetReferenceCount: " + writer3.GetReferenceCount() + "\n");
        }
        // C# destructor will call ->Delete on all C++ object as expected.
        return 0;
    }
}

```

## 12.146 Compute3DSpacing.cxx

```

/*=====
Program: GDCM (Grassroots DICOM). A DICOM library

Copyright (c) 2006-2011 Mathieu Malaterre
All rights reserved.
See Copyright.txt or http://gdcml.sourceforge.net/Copyright.html for details.

This software is distributed WITHOUT ANY WARRANTY; without even
the implied warranty of MERCHANTABILITY or FITNESS FOR A PARTICULAR
PURPOSE. See the above copyright notice for more information.

=====*/
#include "vtkGDCMImageReader2.h"
#include "vtkImageChangeInformation.h"
#include "vtkStringArray.h"
#include "gdcmlPPSorter.h"
#ifdef vtkFloatingPointType
#define vtkFloatingPointType double
#endif
/*
 * Simple example to check computation of spacing within vtkGDCMImageReader2
 * This is a direct implementation of:
 *
 * http://gdcml.sourceforge.net/wiki/index.php/Using_GDCM_API#Automatic_ordering_of_slices_for_vtkGDCMImageReader.SetFileNames
 *
 * For more advanced information on how 3D spacing is being computed see:
 *
 * - http://gdcml.sourceforge.net/html/classgdcml_1_1IPPSorter.html
 *
 * Usage:
 *
 * $ Compute3DSpacing SIEMENS_MAGNETOM-12-MONO2-FileSeq0.dcm \
 *   SIEMENS_MAGNETOM-12-MONO2-FileSeq1.dcm \
 *   SIEMENS_MAGNETOM-12-MONO2-FileSeq2.dcm \
 *   SIEMENS_MAGNETOM-12-MONO2-FileSeq3.dcm
 */
int main(int argc, char *argv[])
{
    if( argc < 2 ) return 1;
}

```

```

std::vector<std::string> filenames;
for( int i = 1; i < argc; ++i )
{
    filenames.push_back( argv[i] );
}
gdcm::IPPSorter s;
s.SetComputeZSpacing( true );
s.SetZSpacingTolerance( 1e-3 );
bool b = s.Sort( filenames );
if( !b )
{
    std::cerr << "Failed to sort files" << std::endl;
    return 1;
}
std::cout << "Sorting succeeded:" << std::endl;
//s.Print( std::cout );
std::cout << "Found z-spacing:" << std::endl;
std::cout << s.GetZSpacing() << std::endl;
const double ippzspacing = s.GetZSpacing();
const std::vector<std::string> & sorted = s.GetFilenames();
vtkGDCMImageReader2 * reader = vtkGDCMImageReader2::New();
vtkStringArray *files = vtkStringArray::New();
std::vector< std::string >::const_iterator it = sorted.begin();
for( ; it != sorted.end(); ++it)
{
    const std::string &f = *it;
    files->InsertNextValue( f.c_str() );
}
reader->SetFileNames( files );
reader->Update();
const vtkFloatingPointType *spacing = reader->GetOutput()->GetSpacing();
vtkImageChangeInformation *v16 = vtkImageChangeInformation::New();
#if (VTK_MAJOR_VERSION >= 6)
v16->SetInputConnection( reader->GetOutputPort() );
#else
v16->SetInput( reader->GetOutput() );
#endif
v16->SetOutputSpacing( spacing[0], spacing[1], ippzspacing );
v16->Update();
v16->GetOutput()->Print( std::cout );
return 0;
}

```

## 12.147 Convert16BitsTo8Bits.cxx

```

/*=====
Program: GDCM (Grassroots DICOM). A DICOM library

Copyright (c) 2006-2011 Mathieu Malaterre
All rights reserved.
See Copyright.txt or http://gdcm.sourceforge.net/Copyright.html for details.

This software is distributed WITHOUT ANY WARRANTY; without even
the implied warranty of MERCHANTABILITY or FITNESS FOR A PARTICULAR
PURPOSE. See the above copyright notice for more information.

=====*/
#include "vtkGDCMImageReader.h"
#include "vtkGDCMImageWriter.h"
#include "vtkImageData.h"
#include "vtkImageCast.h"
#include "gdcmTesting.h"
// The following file is 16/16/15 but the scalar range of the image is [0,192]
// it could be safely stored as 8bits instead:
// gdcmData/012345.002.050.dcm
int main(int, char *[])
{
    const char *directory = gdcm::Testing::GetDataRoot();
    if(!directory) return 1;
    std::string file = std::string(directory) + "/012345.002.050.dcm";
    std::cout << file << std::endl;
    vtkGDCMImageReader *reader = vtkGDCMImageReader::New();
    reader->SetFileName( file.c_str() );
    reader->Update();
    //reader->GetOutput()->Print( std::cout );
    vtkImageCast *cast = vtkImageCast::New();

```

```

#if (VTK_MAJOR_VERSION >= 6)
    cast->SetInputConnection( reader->GetOutputPort() );
#else
    cast->SetInput( reader->GetOutput() );
#endif
cast->SetOutputScalarTypeToUnsignedChar();
vtkGDCMImageWriter *writer = vtkGDCMImageWriter::New();
writer->SetFileName( "/tmp/cast.dcm" );
#if (VTK_MAJOR_VERSION >= 6)
    writer->SetInputConnection( cast->GetOutputPort() );
#else
    writer->SetInput( cast->GetOutput() );
#endif
writer->SetImageFormat( reader->GetImageFormat() );
writer->SetMedicalImageProperties( reader->GetMedicalImageProperties() );
writer->SetDirectionCosines( reader->GetDirectionCosines() );
writer->SetShift( reader->GetShift() );
writer->SetScale( reader->GetScale() );
writer->Write();
reader->Delete();
cast->Delete();
writer->Delete();
return 0;
}

```

## 12.148 ConvertMultiFrameToSingleFrame.cxx

```

/*=====
Program: GDCM (Grassroots DICOM). A DICOM library

Copyright (c) 2006-2011 Mathieu Malaterre
All rights reserved.
See Copyright.txt or http://gdcm.sourceforge.net/Copyright.html for details.

This software is distributed WITHOUT ANY WARRANTY; without even
the implied warranty of MERCHANTABILITY or FITNESS FOR A PARTICULAR
PURPOSE. See the above copyright notice for more information.

=====*/
#include "vtkGDCMImageReader.h"
#include "vtkGDCMImageWriter.h"
#include "vtkImageData.h"
#include "vtkStringArray.h"
#include "gdcmTesting.h"
#include "gdcmFilenameGenerator.h"
int main(int argc, char *argv[])
{
    std::string filename;
    if( argc <= 1 )
    {
        const char *directory = gdcm::Testing::GetDataRoot();
        if(!directory) return 1;
        std::string file = std::string(directory) + "/US-PAL-8-10x-echo.dcm";
        filename = file;
    }
    else
    {
        filename = argv[1];
    }
    std::cout << "file: " << filename << std::endl;
    vtkGDCMImageReader *reader = vtkGDCMImageReader::New();
    reader->SetFileName( filename.c_str() );
    reader->Update();
    //reader->GetOutput()->Print( std::cout );
    int dims[3];
    reader->GetOutput()->GetDimensions( dims );
    std::ostringstream os;
    os << "singleframe";
    os << "%04d.dcm";
    gdcm::FilenameGenerator fg;
    fg.SetPattern( os.str().c_str() );
    unsigned int nfiles = dims[2];
    fg.SetNumberOfFileNames( nfiles );
    bool b = fg.Generate();
    if( !b )
    {

```

```

    std::cerr << "FilenameGenerator::Generate() failed" << std::endl;
    return 1;
}
if( !fg.GetNumberOfFileNames() )
{
    std::cerr << "FilenameGenerator::Generate() failed somehow..." << std::endl;
    return 1;
}
// By default write them as Secondary Capture (for portability)
vtkGDCMImageWriter *writer = vtkGDCMImageWriter::New();
vtkStringArray *filenames = vtkStringArray::New();
for(unsigned int i = 0; i < fg.GetNumberOfFileNames(); ++i)
{
    filenames->InsertNextValue( fg.GetFilename(i) );
}
assert( filenames->GetNumberOfValues() == (int)fg.GetNumberOfFileNames() );
writer->SetFileNames( filenames );
filenames->Delete();
writer->SetFileDimensionality( 2 );
#if (VTK_MAJOR_VERSION >= 6)
    writer->SetInputConnection( reader->GetOutputPort() );
#else
    writer->SetInput( reader->GetOutput() );
#endif
writer->SetImageFormat( reader->GetImageFormat() );
writer->Write();
reader->Delete();
writer->Delete();
return 0;
}

```

## 12.149 ConvertRGBToLuminance.cxx

```

/*=====
Program: GDCM (Grassroots DICOM). A DICOM library

Copyright (c) 2006-2011 Mathieu Malaterre
All rights reserved.
See Copyright.txt or http://gdcm.sourceforge.net/Copyright.html for details.

This software is distributed WITHOUT ANY WARRANTY; without even
the implied warranty of MERCHANTABILITY or FITNESS FOR A PARTICULAR
PURPOSE. See the above copyright notice for more information.

=====*/
#include "vtkGDCMImageReader.h"
#include "vtkGDCMImageWriter.h"
#include "vtkImageData.h"
#include "vtkImageLuminance.h"
#include "gdcmTesting.h"
// There is no such thing as MR Image Storage + Photometric Interpretation = RGB
// let's rewrite that into a proper single component image:
int main(int, char *[])
{
    const char *directory = gdcm::Testing::GetDataRoot();
    if(!directory) return 1;
    std::string file = std::string(directory) + "/SIEMENS-MR-RGB-16Bits.dcm";
    std::cout << file << std::endl;
    vtkGDCMImageReader *reader = vtkGDCMImageReader::New();
    reader->SetFileName( file.c_str() );
    reader->Update();
    //reader->GetOutput()->Print( std::cout );
    vtkImageLuminance *luminance = vtkImageLuminance::New();
    #if (VTK_MAJOR_VERSION >= 6)
        luminance->SetInputConnection( reader->GetOutputPort() );
    #else
        luminance->SetInput( reader->GetOutput() );
    #endif
    vtkGDCMImageWriter *writer = vtkGDCMImageWriter::New();
    writer->SetFileName( "/tmp/bla.dcm" );
    #if (VTK_MAJOR_VERSION >= 6)
        writer->SetInputConnection( luminance->GetOutputPort() );
    #else
        writer->SetInput( luminance->GetOutput() );
    #endif
    //writer->SetImageFormat( reader->GetImageFormat() ); // Do NOT pass image format

```

```

writer->SetMedicalImageProperties( reader->GetMedicalImageProperties() );
writer->SetDirectionCosines( reader->GetDirectionCosines() );
writer->SetShift( reader->GetShift() );
writer->SetScale( reader->GetScale() );
writer->Write();
// TODO:
//vtkImageAppendComponents.h
reader->Delete();
luminance->Delete();
writer->Delete();
return 0;
}

```

## 12.150 ConvertSingleBitTo8Bits.cxx

```

/*=====
Program: GDCM (Grassroots DICOM). A DICOM library

Copyright (c) 2006-2011 Mathieu Malaterre
All rights reserved.
See Copyright.txt or http://gdcm.sourceforge.net/Copyright.html for details.

This software is distributed WITHOUT ANY WARRANTY; without even
the implied warranty of MERCHANTABILITY or FITNESS FOR A PARTICULAR
PURPOSE. See the above copyright notice for more information.

=====*/
#include "vtkGDCMImageReader.h"
#include "vtkGDCMImageWriter.h"
#include "vtkImageData.h"
#include "vtkImageCast.h"
#include "vtkPointData.h"
#include "vtkBitArray.h"
#include "vtkUnsignedCharArray.h"
int main(int argc, char *argv[])
{
    if( argc < 3 )
    {
        return 1;
    }
    const char *filename = argv[1];
    const char *outfilename = argv[2];
    vtkGDCMImageReader *reader = vtkGDCMImageReader::New();
    reader->SetFileName( filename );
    reader->Update();
    //reader->GetOutput()->Print( std::cout );
    vtkDataArray* array = reader->GetOutput()->GetPointData()->GetScalars();
    vtkBitArray *barray = vtkBitArray::SafeDownCast( array );
    if( !barray ) return false;
    vtkIdType nvalues = array->GetNumberOfTuples();
    vtkUnsignedCharArray *uarray = vtkUnsignedCharArray::New();
    uarray->SetNumberOfTuples( nvalues );
    for(vtkIdType i = 0; i < nvalues; ++i)
    {
        uarray->SetValue( i, (unsigned char)barray->GetValue(i) );
    }
    vtkImageData *copy = vtkImageData::New();
    // http://www.vtk.org/Wiki/VTK/VTK_6_Migration/Changes_to_Scalars_Manipulation_Functions#AllocateScalars.28.29
    copy->SetExtent( reader->GetOutput()->GetExtent() );
    #if (VTK_MAJOR_VERSION >= 6)
    copy->AllocateScalars(VTK_UNSIGNED_CHAR, 3);
    #else
    copy->SetScalarType( VTK_UNSIGNED_CHAR );
    copy->AllocateScalars();
    #endif
    //uarray->Print( std::cout );
    //copy->GetPointData()->GetScalars()->Print( std::cout );
    copy->GetPointData()->SetScalars( uarray );
    uarray->Delete();
    vtkGDCMImageWriter *writer = vtkGDCMImageWriter::New();
    writer->SetFileName( outfile );
    //writer->SetInput( cast->GetOutput() );
    #if (VTK_MAJOR_VERSION >= 6)
    writer->SetInputData( copy );
    #else
    writer->SetInput( copy );

```

```

#endif
writer->SetImageFormat( reader->GetImageFormat() );
writer->SetMedicalImageProperties( reader->GetMedicalImageProperties() );
writer->SetDirectionCosines( reader->GetDirectionCosines() );
writer->SetShift( reader->GetShift() );
writer->SetScale( reader->GetScale() );
writer->SetFileDimensionality( reader->GetFileDimensionality() );
writer->Write();
reader->Delete();
copy->Delete();
writer->Delete();
return 0;
}

```

## 12.151 CreateFakePET.cxx

```

/*=====
Program: GDCM (Grassroots DICOM). A DICOM library

Copyright (c) 2006-2011 Mathieu Malaterre
All rights reserved.
See Copyright.txt or http://gdcml.sourceforge.net/Copyright.html for details.

This software is distributed WITHOUT ANY WARRANTY; without even
the implied warranty of MERCHANTABILITY or FITNESS FOR A PARTICULAR
PURPOSE. See the above copyright notice for more information.

=====*/
#include "vtkGDCMImageWriter.h"
#include "vtkImageReader.h"
#include "vtkImageCast.h"
#include "vtkImageData.h"
#include "vtkPointData.h"
#include "vtkDataArray.h"
#include "vtkMedicalImageProperties.h"
#include "vtkStringArray.h"
#include "gdcmlTrace.h"
#include "gdcmlReader.h"
#include "gdcmlWriter.h"
#include "gdcmlAttribute.h"
#include "gdcmlFilenameGenerator.h"
/*
 * Minimal example to create a fake RTDOSE file. The data contains a sphere
 * just for testing.
 * The vtkMedicalImageProperties is not properly filled, but only contains a
 * single field which is required to set the proper SOP Class
 */
int main(int, char *[])
{
    gdcml::Trace::DebugOn();
    const vtkIdType xSize = 512;
    const vtkIdType ySize = 512;
    const vtkIdType zSize = 512;
    // Create the filenames in advance to supply to the vtkGDCMImageWriter
    std::ostream os;
    os << "PT";
    os << "%03d.dcm";
    gdcml::FilenameGenerator fg;
    fg.SetPattern( os.str().c_str() );
    unsigned int nfiles = zSize;
    fg.SetNumberOfFilenames( nfiles );
    bool b = fg.Generate();
    if( !b )
    {
        std::cerr << "FilenameGenerator::Generate() failed" << std::endl;
        return 1;
    }
    if( !fg.GetNumberOfFilenames() )
    {
        std::cerr << "FilenameGenerator::Generate() failed somehow..." << std::endl;
        return 1;
    }
    vtkStringArray *filenames = vtkStringArray::New();
    for(unsigned int i = 0; i < fg.GetNumberOfFilenames(); ++i)
    {
        filenames->InsertNextValue( fg.GetFilename(i) );
    }
}

```

```

    }
    vtkImageData *image = vtkImageData::New();
    image->SetDimensions(xSize,ySize,zSize);
    image->SetOrigin(-350.684,350.0,890.76);
    image->SetSpacing(5.4688,-5.4688,-3.27);
#ifdef VTK_MAJOR_VERSION <= 5
    image->SetNumberOfScalarComponents(1);
    image->SetScalarTypeToDouble();
#else
    image->AllocateScalars(VTK_DOUBLE,1);
#endif
    double pt[3];
    for( int z = 0; z < zSize; ++z )
        for( int y = 0; y < ySize; ++y )
            for( int x = 0; x < xSize; ++x )
                {
                pt[0] = x;
                pt[1] = y;
                pt[2] = z;
                pt[0] -= xSize / 2;
                pt[1] -= ySize / 2;
                pt[2] -= zSize / 2;
                pt[0] /= xSize / 2;
                pt[1] /= ySize / 2;
                pt[2] /= zSize / 2;
                const double unit = pt[0] * pt[0] + pt[1] * pt[1] + pt[2] * pt[2];
                const double inval = unit <= 1. ? (3 * unit + 7) : 0.; // just for fun => max == 10.
                double* pixel= static_cast<double*>(image->GetScalarPointer(x,y,z));
                pixel[0] = inval;
                }
    vtkGDCMImageWriter *writer = vtkGDCMImageWriter::New();
    writer->SetFileDimensionality( 2 );
    writer->SetFileNames( filenames );
#ifdef (VTK_MAJOR_VERSION >= 6)
    writer->SetInputData( image );
#else
    writer->SetInput( image );
#endif
    writer->GetMedicalImageProperties()->SetSliceThickness("1.5");
    writer->GetMedicalImageProperties()->SetModality( "PT " );
    writer->SetScale( 0.0042 ); // why not
    writer->Write();
    image->Delete();
    writer->Delete();
    return 0;
}

```

## 12.152 CreateFakeRTDOSE.cxx

```

/*=====
Program: GDCM (Grassroots DICOM). A DICOM library

Copyright (c) 2006-2011 Mathieu Malaterre
All rights reserved.
See Copyright.txt or http://gdcms.sourceforge.net/Copyright.html for details.

This software is distributed WITHOUT ANY WARRANTY; without even
the implied warranty of MERCHANTABILITY or FITNESS FOR A PARTICULAR
PURPOSE. See the above copyright notice for more information.

=====*/
#include "vtkGDCMImageWriter.h"
#include "vtkImageReader.h"
#include "vtkImageCast.h"
#include "vtkImageData.h"
#include "vtkPointData.h"
#include "vtkDataArray.h"
#include "vtkMedicalImageProperties.h"
#include "gdcmTrace.h"
#include "gdcmReader.h"
#include "gdcmWriter.h"
#include "gdcmAttribute.h"
/*
 * Minimal example to create a fake RTDOSE file. The data contains a sphere
 * just for testing.
 * The vtkMedicalImageProperties is not properly filled, but only contains a

```



```

* single field which is required to set the proper SOP Class
*/
int main(int, char *[])
{
    //gdcm::Trace::DebugOn();
    const vtkIdType xSize = 512;
    const vtkIdType ySize = 512;
    const vtkIdType zSize = 512;
    vtkImageData *image = vtkImageData::New();
    image->SetDimensions(xSize,ySize,zSize);
    image->SetOrigin(-350.684,350.0,890.76);
    image->SetSpacing(5.4688,-5.4688,-3.27);
#if VTK_MAJOR_VERSION <= 5
    image->SetNumberOfScalarComponents(1);
    image->SetScalarTypeToDouble();
#else
    image->AllocateScalars(VTK_DOUBLE,1);
#endif
    double pt[3];
    for( int z = 0; z < zSize; ++z )
        for( int y = 0; y < ySize; ++y )
            for( int x = 0; x < xSize; ++x )
                {
                    pt[0] = x;
                    pt[1] = y;
                    pt[2] = z;
                    pt[0] -= xSize / 2;
                    pt[1] -= ySize / 2;
                    pt[2] -= zSize / 2;
                    pt[0] /= xSize / 2;
                    pt[1] /= ySize / 2;
                    pt[2] /= zSize / 2;
                    const double unit = pt[0] * pt[0] + pt[1] * pt[1] + pt[2] * pt[2];
                    const double inval = unit <= 1. ? (3 * unit + 7) : 0.; // just for fun => max == 10.
                    double* pixel= static_cast<double*>(image->GetScalarPointer(x,y,z));
                    pixel[0] = inval;
                }
    vtkGDCMImageWriter *writer = vtkGDCMImageWriter::New();
    writer->SetFileDimensionality( 3 );
    writer->SetFileName( "rtdose.dcm" );
#if (VTK_MAJOR_VERSION >= 6)
    writer->SetInputData( image );
#else
    writer->SetInput( image );
#endif
    writer->GetMedicalImageProperties()->SetSliceThickness("1.5");
    writer->GetMedicalImageProperties()->AddUserDefinedValue( "Dose Units", "GY");
    writer->GetMedicalImageProperties()->AddUserDefinedValue( "Dose Summation Type", "PLAN");
    writer->GetMedicalImageProperties()->AddUserDefinedValue( "Dose Type", "PHYSICAL");
    writer->GetMedicalImageProperties()->AddUserDefinedValue( "Frame of Reference UID",
        "1.3.12.2.1107.5.6.1.68100.30270111041215391275000000001");
    writer->GetMedicalImageProperties()->SetModality( "RTDOSE" );
    //writer->GetMedicalImageProperties()->SetModality( "PT" ); // debug
    writer->SetScale( 0.0042 ); // why not
    writer->Write();
    image->Delete();
    writer->Delete();
    // BEGIN HACK
    // In GDCM version 2.4.3 and before, the following tag was missing which caused issue with some RTDose
    // software:
    // Open the DICOM file that was temporarily created. This will allows me to used
    // GDCM to append specific tags that allows the RTDOSE to be associated with the
    // relevant CT images.
    gdcm::Reader reader2;
    reader2.SetFileName("rtdose.dcm" );
    reader2.Read();
    gdcm::File &file = reader2.GetFile();
    gdcm::DataSet &ds = file.GetDataSet();
    // Required by some software and not automagically added by GDCM in old version
    gdcm::Attribute<0x0028,0x0009> framePointer;
    framePointer.SetNumberOfValues(1);
    framePointer.SetValue( gdcm::Tag(0x3004,0x000C) );
    ds.Replace( framePointer.GetAsDataElement() );
    gdcm::Writer writer2;
    writer2.CheckFileMetaInformationOff();
    writer2.SetFileName("rtdose2.dcm");
    writer2.SetFile( file );
    writer2.Write();
    // END HACK
    return 0;
}

```

## 12.153 GenerateRTSTRUCT.cxx

```

/*=====
Program: GDCM (Grassroots DICOM). A DICOM library

Copyright (c) 2006-2011 Mathieu Malaterre
All rights reserved.
See Copyright.txt or http://gdcm.sourceforge.net/Copyright.html for details.

This software is distributed WITHOUT ANY WARRANTY; without even
the implied warranty of MERCHANTABILITY or FITNESS FOR A PARTICULAR
PURPOSE. See the above copyright notice for more information.

=====*/
#include "vtkGDCMPolyDataWriter.h"
#include "vtkGDCMPolyDataReader.h"
#include "vtkPolyData.h"
#include "vtkPolyDataReader.h"
#include "vtkMedicalImageProperties.h"
#include "vtkRTStructSetProperties.h"
#include "vtkStringArray.h"
#include "vtkAppendPolyData.h"
#include "vtkPolyDataWriter.h"
#include "vtkPolyDataMapper.h"
#include "vtkPolyDataMapper2D.h"
#include "vtkActor2D.h"
#include "vtkRenderWindowInteractor.h"
#include "vtkMedicalImageProperties.h"
#include "vtkRenderWindow.h"
#include "vtkRenderer.h"
#include "vtkCamera.h"
#include "vtkProperty.h"
#include "vtkProperty2D.h"
#include "vtkImageData.h"
#include <algorithm> //for std::find
#include "gdcmDirectoryHelper.h"
using namespace gdcm;
//view each organ independently of the others, to make sure that
//organ names correspond to actual segmentations.
void ShowOrgan(vtkPolyData* inData)
{
    // Now we'll look at it.
    vtkPolyDataMapper *cubeMapper = vtkPolyDataMapper::New();
    #if (VTK_MAJOR_VERSION >= 6)
        cubeMapper->SetInputData( inData );
    #else
        cubeMapper->SetInput( inData );
    #endif
    cubeMapper->SetScalarRange(0,7);
    vtkActor *cubeActor = vtkActor::New();
    cubeActor->SetMapper(cubeMapper);
    vtkProperty *property = cubeActor->GetProperty();
    property->SetRepresentationToWireframe();
    vtkRenderer *renderer = vtkRenderer::New();
    vtkRenderWindow *renWin = vtkRenderWindow::New();
    renWin->AddRenderer(renderer);
    vtkRenderWindowInteractor *iren = vtkRenderWindowInteractor::New();
    iren->SetRenderWindow(renWin);
    renderer->AddActor(cubeActor);
    renderer->ResetCamera();
    renderer->SetBackground(1,1,1);
    renWin->SetSize(300,300);
    renWin->Render();
    iren->Start();
    cubeMapper->Delete();
    cubeActor->Delete();
    renderer->Delete();
    renWin->Delete();
    iren->Delete();
}
/*
 * Full application which ... RTSTRUCT
 */
int main(int argc, char *argv[])
{
    if( argc < 2 )
    {
        std::cerr << argv[0] << " directory-with-rtstruct-and-ct-images\n";
        return 1;
    }
}

```

```

    }
    std::string theDirName(argv[1]);
    Directory::FileNamesType theRTSeries =
        DirectoryHelper::GetRTStructSeriesUIDs(theDirName);
    gdcm::Directory theDir;
    theDir.Load(argv[1]);
    if (theRTSeries.empty())
    {
        std::cerr << "No RTStructs found for the test, ending." << std::endl;
        return 1;
    }
    for (size_t q = 0; q < theRTSeries.size(); q++)
    {
        Directory::FileNamesType theRTNames =
            DirectoryHelper::GetFileNamesFromSeriesUIDs(theDirName, theRTSeries[q]);
        if (theRTNames.empty()){
            std::cerr << "Unable to load RT Series " << theRTSeries[q] << ", continuing. " << std::endl;
            continue;
        }
        vtkGDCMPolyDataReader * reader = vtkGDCMPolyDataReader::New();
        reader->SetFileName( theRTNames[0].c_str() );
        reader->Update();
        //std::cout << reader->GetMedicalImageProperties()->GetStudyDate() << std::endl;
        vtkGDCMPolyDataWriter * writer = vtkGDCMPolyDataWriter::New();
        int numMasks = reader->GetNumberOfOutputPorts() + 1; //add a blank one in
        writer->SetNumberOfInputPorts( numMasks );
        std::string thePotentialName = theDirName + "/" + "GDCMTestRTStruct." + theRTSeries[q] + ".dcm";
        gdcm::Directory::FileNamesType theFileNames = theDir.GetFileNames();
        //keep renaming the output until we get something that doesn't overwrite what was there already
        int count = 0;
        while (std::find(theFileNames.begin(), theFileNames.end(), thePotentialName) != theFileNames.end())
        {
            char buff[255];
            sprintf(buff, "%d", count);
            thePotentialName = theDirName + "/" + "GDCMTestRTStruct." + buff + "." + theRTSeries[q] + ".dcm";
        }
        writer->SetFileName( thePotentialName.c_str() );
        writer->SetMedicalImageProperties( reader->GetMedicalImageProperties() );
        //this line is cheating, we won't have the same stuff, and may not have a struct
        //to start with.
        //have to go back to the original data to reconstruct the RTStructureSetProperties
        //writer->SetRTStructSetProperties( reader->GetRTStructSetProperties() );
        //writer->Write();
        //loop through the outputs in order to write them out as if they had been created and appended
        vtkStringArray* roiNames = vtkStringArray::New();
        vtkStringArray* roiAlgorithms = vtkStringArray::New();
        vtkStringArray* roiTypes = vtkStringArray::New();
        roiNames->SetNumberOfValues(numMasks);
        roiAlgorithms->SetNumberOfValues(numMasks);
        roiTypes->SetNumberOfValues(numMasks);
        vtkAppendPolyData* append = vtkAppendPolyData::New();
        //ok, now we'll add a blank organ
        //the blank organ is to test to ensure that blank organs work; there have been crash reports
        //this code is added at the beginning to ensure that the blank organs are read
        //and preserved as individual organs.
        vtkPolyData* blank = vtkPolyData::New();
        #if (VTK_MAJOR_VERSION >= 6)
            writer->SetInputData(0, blank);
        #else
            writer->SetInput(0, blank);
        #endif
        roiNames->InsertValue(0, "blank");
        roiAlgorithms->InsertValue(0, "blank");
        roiTypes->InsertValue(0, "ORGAN");
        //note the offsets used to place the blank rtstruct at the beginning of the newly generated RT.
        //the idea is to run the program twice; first to generate an rtstruct with a blank mask (making
        //sure that that functionality works), and then a second time to make sure that everything is
        //being read properly. Multiple organs with the same name could cause some strangenesses.
        for (int i = 1; i < numMasks; ++i)
        {
            #if (VTK_MAJOR_VERSION >= 6)
                writer->SetInputConnection(i, reader->GetOutputPort(i-1));
                append->AddInputConnection(reader->GetOutputPort(i-1));
            #else
                writer->SetInput(i, reader->GetOutput(i-1));
                append->AddInput(reader->GetOutput(i-1));
            #endif
            std::string theString = reader->GetRTStructSetProperties()->GetStructureSetROIName(i-1);
            roiNames->InsertValue(i, theString);
            theString = reader->GetRTStructSetProperties()->GetStructureSetROIGenerationAlgorithm(i-1);
            roiAlgorithms->InsertValue(i, theString);
        }
    }
}

```

```

        theString = reader->GetRTStructSetProperties()->GetStructureSetRTROIInterpretedType(i-1);
        roiTypes->InsertValue(i, theString);
        ShowOrgan(reader->GetOutput(i-1));
    }
    vtkRTStructSetProperties* theProperties = vtkRTStructSetProperties::New();
    writer->SetRTStructSetProperties(theProperties);
    writer->InitializeRTStructSet(theDirName,
        reader->GetRTStructSetProperties()->GetStructureSetLabel(),
        reader->GetRTStructSetProperties()->GetStructureSetName(),
        roiNames, roiAlgorithms, roiTypes);
    writer->SetRTStructSetProperties(theProperties);
    writer->Write();
    // print reader output:
    reader->Print( std::cout );
    // print first output:
    reader->GetOutput()->Print( std::cout );
    reader->Delete();
    append->Delete();
    roiNames->Delete();
    roiTypes->Delete();
    theProperties->Delete();
    roiAlgorithms->Delete();
    blank->Delete();
    writer->Delete();
}
return 0;
}

```

## 12.154 MagnifyFile.cxx

```

/*=====
Program: GDCM (Grassroots DICOM). A DICOM library

Copyright (c) 2006-2011 Mathieu Malaterre
All rights reserved.
See Copyright.txt or http://gdcm.sourceforge.net/Copyright.html for details.

This software is distributed WITHOUT ANY WARRANTY; without even
the implied warranty of MERCHANTABILITY or FITNESS FOR A PARTICULAR
PURPOSE. See the above copyright notice for more information.

=====*/
#include "vtkGDCMImageReader.h"
#include "vtkGDCMImageWriter.h"
#include "vtkImageData.h"
#include "vtkImageMagnify.h"
#include "vtkImageCast.h"
#include "gdcmTesting.h"
#include "gdcmSystem.h"
// This is a simple test to magnify an image that is known to give excellent
// compression ratio. This will be our test for those large image
int main(int, char *[])
{
    const char *directory = gdcm::Testing::GetDataRoot();
    if(!directory) return 1;
    std::string file = std::string(directory) + "/test.acr";
    std::cout << file << std::endl;
    if( !gdcm::System::FileExists( file.c_str() ) ) return 1;
    vtkGDCMImageReader *reader = vtkGDCMImageReader::New();
    reader->SetFileName( file.c_str() );
    reader->Update();
    //reader->GetOutput()->Print( std::cout );
    vtkImageCast *cast = vtkImageCast::New();
    #if (VTK_MAJOR_VERSION >= 6)
        cast->SetInputConnection( reader->GetOutputPort() );
    #else
        cast->SetInput( reader->GetOutput() );
    #endif
    cast->SetOutputScalarTypeToUnsignedShort();
    vtkImageMagnify *magnify = vtkImageMagnify::New();
    #if (VTK_MAJOR_VERSION >= 6)
        magnify->SetInputConnection( cast->GetOutputPort() );
    #else
        magnify->SetInput( cast->GetOutput() );
    #endif
    magnify->SetInterpolate( 1 );
}

```

```

magnify->SetInterpolate( 0 );
int factor = 100;
magnify->SetMagnificationFactors (factor, factor, 1);
vtkGDCMImageWriter *writer = vtkGDCMImageWriter::New();
writer->SetFileName( "/tmp/bla.dcm" );
#if (VTK_MAJOR_VERSION >= 6)
writer->SetInputConnection( magnify->GetOutputPort() );
#else
writer->SetInput( magnify->GetOutput() );
#endif
writer->SetImageFormat( reader->GetImageFormat() );
writer->SetMedicalImageProperties( reader->GetMedicalImageProperties() );
writer->SetDirectionCosines( reader->GetDirectionCosines() );
writer->SetShift( reader->GetShift() );
writer->SetScale( reader->GetScale() );
writer->Write();
// TODO:
//vtkImageAppendComponents.h
reader->Delete();
magnify->Delete();
writer->Delete();
return 0;
}

```

## 12.155 gdcmortoplanes.cxx

```

/*=====
Program: GDCM (Grassroots DICOM). A DICOM library

Copyright (c) 2006-2011 Mathieu Malaterre
All rights reserved.
See Copyright.txt or http://gdc.sourceforge.net/Copyright.html for details.

This software is distributed WITHOUT ANY WARRANTY; without even
the implied warranty of MERCHANTABILITY or FITNESS FOR A PARTICULAR
PURPOSE. See the above copyright notice for more information.

=====*/
#include "vtkActor.h"
#include "vtkCamera.h"
#include "vtkMatrix4x4.h"
#include "vtkTransform.h"
#include "vtkAssembly.h"
#include "vtkCellPicker.h"
#include "vtkCommand.h"
#include "vtkImageActor.h"
#include "vtkImageMapToColors.h"
#include "vtkImageOrthoPlanes.h"
#include "vtkImagePlaneWidget.h"
#include "vtkImageReader.h"
#include "vtkInteractorEventRecorder.h"
#include "vtkLookupTable.h"
#include "vtkOutlineFilter.h"
#include "vtkPolyDataMapper.h"
#include "vtkProperty.h"
#include "vtkRenderWindow.h"
#include "vtkRenderWindowInteractor.h"
#include "vtkRenderer.h"
#include "vtkVolume16Reader.h"
#include "vtkImageData.h"
#include "vtkImageChangeInformation.h"
#include "vtkOrientationMarkerWidget.h"
#include "vtkAnnotatedCubeActor.h"
#include "vtkAxesActor.h"
#include "vtkCaptionActor2D.h"
#include "vtkTextProperty.h"
#include "vtkPropAssembly.h"
#include "vtkGDCMImageReader.h"
#include "vtkGDCMImageWriter.h"
#include "vtkStringArray.h"
#include "gdcmsystem.h"
#include "gdcmdir.h"
#include "gdcmpp.h"
#ifdef vtkFloatingPointType
#define vtkFloatingPointType double
#endif

```

```

//-----
class vtkOrthoPlanesCallback : public vtkCommand
{
public:
    static vtkOrthoPlanesCallback *New()
    { return new vtkOrthoPlanesCallback; }
    void Execute( vtkObject *caller, unsigned long vtkNotUsed( event ),
                void *callData )
    {
        vtkImagePlaneWidget* self =
            reinterpret_cast< vtkImagePlaneWidget* >( caller );
        if(!self) return;
        double* wl = static_cast<double*>( callData );
        if ( self == this->WidgetX )
        {
            this->WidgetY->SetWindowLevel(wl[0],wl[1],1);
            this->WidgetZ->SetWindowLevel(wl[0],wl[1],1);
        }
        else if( self == this->WidgetY )
        {
            this->WidgetX->SetWindowLevel(wl[0],wl[1],1);
            this->WidgetZ->SetWindowLevel(wl[0],wl[1],1);
        }
        else if (self == this->WidgetZ)
        {
            this->WidgetX->SetWindowLevel(wl[0],wl[1],1);
            this->WidgetY->SetWindowLevel(wl[0],wl[1],1);
        }
    }
    vtkOrthoPlanesCallback():WidgetX( 0 ), WidgetY( 0 ), WidgetZ ( 0 ) {}
    vtkImagePlaneWidget* WidgetX;
    vtkImagePlaneWidget* WidgetY;
    vtkImagePlaneWidget* WidgetZ;
};

int main( int argc, char *argv[] )
{
    //char* fname = vtkTestUtilities::ExpandDataFileName(argc, argv, "Data/headsq/quarter");
    //vtkVolume16Reader* v16 = vtkVolume16Reader::New();
    // v16->SetDataDimensions( 64, 64);
    // v16->SetDataByteOrderToLittleEndian();
    // v16->SetImageRange( 1, 93);
    // v16->SetDataSpacing( 3.2, 3.2, 1.5);
    // v16->SetFilePrefix( fname );
    // v16->SetDataMask( 0x7fff);
    // v16->Update();
    std::vector<std::string> filenames;
    if( argc < 2 )
    {
        std::cerr << argv[0] << " filename1.dcm [filename2.dcm ...]\n";
        return 1;
    }
    else
    {
        // Is it a single directory ? If so loop over all files contained in it:
        const char *filename = argv[1];
        if( argc == 2 && gdcmm::System::FileIsDirectory( filename ) )
        {
            std::cout << "Loading directory: " << filename << std::endl;
            bool recursive = false;
            gdcmm::Directory d;
            d.Load(filename, recursive);
            gdcmm::Directory::FileNamesType const &files = d.GetFiles();
            for( gdcmm::Directory::FileNamesType::const_iterator it = files.begin(); it != files.end(); ++it )
            {
                filenames.push_back( it->c_str() );
            }
        }
        else // list of files passed directly on the cmd line:
            // discard non-existing or directory
        {
            for(int i=1; i < argc; ++i)
            {
                filename = argv[i];
                if( gdcmm::System::FileExists( filename ) )
                {
                    if( gdcmm::System::FileIsDirectory( filename ) )
                    {
                        std::cerr << "Discarding directory: " << filename << std::endl;
                    }
                    else
                    {

```

```

        filenames.push_back( filename );
    }
}
else
{
    std::cerr << "Discarding non existing file: " << filename << std::endl;
}
}
}
//names->Print( std::cout );
}
vtkGDCMImageReader * reader = vtkGDCMImageReader::New();
double ippzspacing;
if( filenames.size() > 1 )
{
    //gdcm::Trace::DebugOn();
    //gdcm::Trace::WarningOn();
    gdcm::IPPSorter s;
    s.SetComputeZSpacing( true );
    s.SetZSpacingTolerance( 1e-3 );
    bool b = s.Sort( filenames );
    if( !b )
    {
        std::cerr << "Failed to sort files" << std::endl;
        return 1;
    }
    std::cout << "Sorting succeeded:" << std::endl;
    s.Print( std::cout );
    std::cout << "Found z-spacing:" << std::endl;
    std::cout << s.GetZSpacing() << std::endl;
    ippzspacing = s.GetZSpacing();
    const std::vector<std::string> & sorted = s.GetFileNames();
    vtkStringArray *files = vtkStringArray::New();
    std::vector< std::string >::const_iterator it = sorted.begin();
    for( ; it != sorted.end(); ++it )
    {
        const std::string &f = *it;
        files->InsertNextValue( f.c_str() );
    }
    reader->SetFileNames( files );
    //reader->SetFileLowerLeft( 1 );
    reader->Update(); // important
    files->Delete();
}
else
{
    reader->SetFileName( argv[1] );
    reader->Update(); // important
    ippzspacing = reader->GetOutput()->GetSpacing()[2];
    ippzspacing = 4;
}
//reader->GetOutput()->Print( std::cout );
//vtkFloatingPointType range[2];
//reader->GetOutput()->GetScalarRange(range);
//std::cout << "Range: " << range[0] << " " << range[1] << std::endl;
const vtkFloatingPointType *spacing = reader->GetOutput()->GetSpacing();
vtkImageChangeInformation *v16 = vtkImageChangeInformation::New();
#if (VTK_MAJOR_VERSION >= 6)
    v16->SetInputConnection( reader->GetOutputPort() );
#else
    v16->SetInput( reader->GetOutput() );
#endif
v16->SetOutputSpacing( spacing[0], spacing[1], ippzspacing );
v16->Update();
#if 0
    vtkGDCMImageWriter *writer = vtkGDCMImageWriter::New();
    writer->SetInput( v16->GetOutput() );
    writer->SetFileLowerLeft( reader->GetFileLowerLeft() );
    writer->SetDirectionCosines( reader->GetDirectionCosines() );
    writer->SetImageFormat( reader->GetImageFormat() );
    writer->SetFileDimensionality( 3 ); //reader->GetFileDimensionality();
    writer->SetMedicalImageProperties( reader->GetMedicalImageProperties() );
    writer->SetShift( reader->GetShift() );
    writer->SetScale( reader->GetScale() );
    writer->SetFileName( "out.dcm" );
    writer->Write();
#endif
vtkOutlineFilter* outline = vtkOutlineFilter::New();
outline->SetInputConnection( v16->GetOutputPort() );
vtkPolyDataMapper* outlineMapper = vtkPolyDataMapper::New();
outlineMapper->SetInputConnection( outline->GetOutputPort() );

```

```

vtkActor* outlineActor = vtkActor::New();
outlineActor->SetMapper( outlineMapper);
vtkRenderer* ren1 = vtkRenderer::New();
vtkRenderer* ren2 = vtkRenderer::New();
vtkRenderWindow* renWin = vtkRenderWindow::New();
renWin->AddRenderer(ren2);
renWin->AddRenderer(ren1);
vtkRenderWindowInteractor* iren = vtkRenderWindowInteractor::New();
iren->SetRenderWindow(renWin);
vtkCellPicker* picker = vtkCellPicker::New();
picker->SetTolerance(0.005);
vtkProperty* ipwProp = vtkProperty::New();
//assign default props to the ipw's texture plane actor
vtkImagePlaneWidget* planeWidgetX = vtkImagePlaneWidget::New();
planeWidgetX->SetInteractor( iren);
planeWidgetX->SetKeyPressActivationValue('x');
planeWidgetX->SetPicker(picker);
planeWidgetX->RestrictPlaneToVolumeOn();
planeWidgetX->GetPlaneProperty()->SetColor(1,0,0);
planeWidgetX->SetTexturePlaneProperty(ipwProp);
planeWidgetX->TextureInterpolateOff();
planeWidgetX->SetResliceInterpolateToNearestNeighbour();
#if (VTK_MAJOR_VERSION >= 6)
planeWidgetX->SetInputConnection(v16->GetOutputPort());
#else
planeWidgetX->SetInput(v16->GetOutput());
#endif
planeWidgetX->SetPlaneOrientationToXAxes();
//planeWidgetX->SetSliceIndex(32);
planeWidgetX->DisplayTextOn();
planeWidgetX->On();
planeWidgetX->InteractionOff();
planeWidgetX->InteractionOn();
vtkImagePlaneWidget* planeWidgetY = vtkImagePlaneWidget::New();
planeWidgetY->SetInteractor( iren);
planeWidgetY->SetKeyPressActivationValue('y');
planeWidgetY->SetPicker(picker);
planeWidgetY->GetPlaneProperty()->SetColor(1,1,0);
planeWidgetY->SetTexturePlaneProperty(ipwProp);
planeWidgetY->TextureInterpolateOn();
planeWidgetY->SetResliceInterpolateToLinear();
#if (VTK_MAJOR_VERSION >= 6)
planeWidgetY->SetInputConnection(v16->GetOutputPort());
#else
planeWidgetY->SetInput(v16->GetOutput());
#endif
planeWidgetY->SetPlaneOrientationToYAxes();
//planeWidgetY->SetSlicePosition(102.4);
planeWidgetY->SetLookupTable( planeWidgetX->GetLookupTable());
planeWidgetY->DisplayTextOn();
planeWidgetY->UpdatePlacement();
planeWidgetY->On();
vtkImagePlaneWidget* planeWidgetZ = vtkImagePlaneWidget::New();
planeWidgetZ->SetInteractor( iren);
planeWidgetZ->SetKeyPressActivationValue('z');
planeWidgetZ->SetPicker(picker);
planeWidgetZ->GetPlaneProperty()->SetColor(0,0,1);
planeWidgetZ->SetTexturePlaneProperty(ipwProp);
planeWidgetZ->TextureInterpolateOn();
planeWidgetZ->SetResliceInterpolateToCubic();
#if (VTK_MAJOR_VERSION >= 6)
planeWidgetZ->SetInputConnection(v16->GetOutputPort());
#else
planeWidgetZ->SetInput(v16->GetOutput());
#endif
planeWidgetZ->SetPlaneOrientationToZAxes();
//planeWidgetZ->SetSliceIndex(25);
planeWidgetZ->SetLookupTable( planeWidgetX->GetLookupTable());
planeWidgetZ->DisplayTextOn();
planeWidgetZ->On();
vtkImageOrthoPlanes* orthoPlanes = vtkImageOrthoPlanes::New();
orthoPlanes->SetPlane(0, planeWidgetX);
orthoPlanes->SetPlane(1, planeWidgetY);
orthoPlanes->SetPlane(2, planeWidgetZ);
orthoPlanes->ResetPlanes();
vtkOrthoPlanesCallback* cbk = vtkOrthoPlanesCallback::New();
cbk->WidgetX = planeWidgetX;
cbk->WidgetY = planeWidgetY;
cbk->WidgetZ = planeWidgetZ;
planeWidgetX->AddObserver( vtkCommand::EndWindowLevelEvent, cbk );
planeWidgetY->AddObserver( vtkCommand::EndWindowLevelEvent, cbk );

```



```

    planeWidgetZ->AddObserver( vtkCommand::EndWindowLevelEvent, cbk );
    cbk->Delete();
    double wl[2];
    planeWidgetZ->GetWindowLevel(wl);
    // Add a 2D image to test the GetReslice method
    //
    vtkImageMapToColors* colorMap = vtkImageMapToColors::New();
    colorMap->PassAlphaToOutputOff();
    colorMap->SetActiveComponent(0);
    colorMap->SetOutputFormatToLuminance();
    #if (VTK_MAJOR_VERSION >= 6)
        colorMap->SetInputData(planeWidgetZ->GetResliceOutput());
    #else
        colorMap->SetInput(planeWidgetZ->GetResliceOutput());
    #endif
    colorMap->SetLookupTable(planeWidgetX->GetLookupTable());
    vtkImageActor* imageActor = vtkImageActor::New();
    imageActor->PickableOff();
    #if (VTK_MAJOR_VERSION >= 6)
        imageActor->SetInputData(colorMap->GetOutput());
    #else
        imageActor->SetInput(colorMap->GetOutput());
    #endif
    // Add the actors
    //
    ren1->AddActor( outlineActor);
    ren2->AddActor( imageActor);
    ren1->SetBackground( 0.1, 0.1, 0.2);
    ren2->SetBackground( 0.2, 0.1, 0.2);
    renWin->SetSize( 600, 350);
    ren1->SetViewport(0,0,0.58333,1);
    ren2->SetViewport(0.58333,0,1,1);
    // Set the actors' postions
    //
    renWin->Render();
    //iren->SetEventPosition( 175,175);
    //iren->SetKeyCode('r');
    //iren->InvokeEvent(vtkCommand::CharEvent,NULL);
    //iren->SetEventPosition( 475,175);
    //iren->SetKeyCode('r');
    //iren->InvokeEvent(vtkCommand::CharEvent,NULL);
    //renWin->Render();
    //ren1->GetActiveCamera()->Elevation(110);
    //ren1->GetActiveCamera()->SetViewUp(0, 0, -1);
    //ren1->GetActiveCamera()->Azimuth(45);
    //ren1->GetActiveCamera()->Dolly(1.15);
    ren1->ResetCameraClippingRange();
    vtkAnnotatedCubeActor* cube = vtkAnnotatedCubeActor::New();
    cube->SetXPlusFaceText ( "R" );
    cube->SetXMinusFaceText ( "L" );
    cube->SetYPlusFaceText ( "A" );
    cube->SetYMinusFaceText ( "P" );
    cube->SetZPlusFaceText ( "H" );
    cube->SetZMinusFaceText ( "F" );
    cube->SetFaceTextScale( 0.666667 );
    vtkAxesActor* axes2 = vtkAxesActor::New();
    vtkMatrix4x4 *invert = vtkMatrix4x4::New();
    invert->DeepCopy( reader->GetDirectionCosines() );
    invert->Invert();
    // simulate a left-handed coordinate system
    //
    vtkTransform *transform = vtkTransform::New();
    transform->Identity();
    //transform->RotateY(90);
    transform->Concatenate( invert);
    axes2->SetShaftTypeToCylinder();
    axes2->SetUserTransform( transform );
    cube->GetAssembly()->SetUserTransform( transform );
    axes2->SetTotalLength( 1.5, 1.5, 1.5 );
    axes2->SetCylinderRadius( 0.500 * axes2->GetCylinderRadius() );
    axes2->SetConeRadius ( 1.025 * axes2->GetConeRadius() );
    axes2->SetSphereRadius ( 1.500 * axes2->GetSphereRadius() );
    vtkTextProperty* tprop = axes2->GetXAxisCaptionActor2D()->
        GetCaptionTextProperty();
    tprop->ItalicOn();
    tprop->ShadowOn();
    tprop->SetFontFamilyToTimes();
    axes2->GetYAxisCaptionActor2D()->GetCaptionTextProperty()->ShallowCopy( tprop );
    axes2->GetZAxisCaptionActor2D()->GetCaptionTextProperty()->ShallowCopy( tprop );
    vtkPropAssembly* assembly = vtkPropAssembly::New();
    assembly->AddPart( axes2 );

```

```

assembly->AddPart( cube );
vtkOrientationMarkerWidget* widget = vtkOrientationMarkerWidget::New();
widget->SetOutlineColor( 0.9300, 0.5700, 0.1300 );
widget->SetOrientationMarker( assembly );
widget->SetInteractor( iren );
widget->SetViewport( 0.0, 0.0, 0.4, 0.4 );
widget->SetEnabled( 1 );
widget->InteractiveOff();
widget->InteractiveOn();
// Playback recorded events
//
//vtkInteractorEventRecorder *recorder = vtkInteractorEventRecorder::New();
//recorder->SetInteractor(iren);
//recorder->ReadFromInputStringOn();
//recorder->SetInputString(IOEventLog);
// Interact with data
// Render the image
//
iren->Initialize();
renWin->Render();
// Test SetKeyPressActivationValue for one of the widgets
//
//iren->SetKeyCode('z');
//iren->InvokeEvent(vtkCommand::CharEvent,NULL);
//iren->SetKeyCode('z');
//iren->InvokeEvent(vtkCommand::CharEvent,NULL);
//int retVal = vtkRegressionTestImage( renWin );
//
//if ( retVal == vtkRegressionTester::DO_INTERACTOR)
//{
//    iren->Start();
//}
// Clean up
//
//recorder->Off();
//recorder->Delete();
ipwProp->Delete();
orthoPlanes->Delete();
planeWidgetX->Delete();
planeWidgetY->Delete();
planeWidgetZ->Delete();
colorMap->Delete();
imageActor->Delete();
picker->Delete();
outlineActor->Delete();
outlineMapper->Delete();
outline->Delete();
iren->Delete();
renWin->Delete();
ren1->Delete();
ren2->Delete();
v16->Delete();
reader->Delete();
return 0;
}

```

## 12.156 gdcmlreslice.cxx

```

/*=====
Program: GDCM (Grassroots DICOM). A DICOM library

Copyright (c) 2006-2011 Mathieu Malaterre
All rights reserved.
See Copyright.txt or http://gdcml.sourceforge.net/Copyright.html for details.

This software is distributed WITHOUT ANY WARRANTY; without even
the implied warranty of MERCHANTABILITY or FITNESS FOR A PARTICULAR
PURPOSE. See the above copyright notice for more information.

=====*/
#include "vtkGDCMImageReader.h"
#include "vtkRenderer.h"
#include "vtkAssembly.h"
#include "vtkImageFlip.h"
#include "vtkImageReslice.h"
#include "vtkRenderWindow.h"

```

```

#include "vtkAnnotatedCubeActor.h"
#include "vtkTransform.h"
#include "vtkAxesActor.h"
#include "vtkTextProperty.h"
#include "vtkCaptionActor2D.h"
#include "vtkPropAssembly.h"
#include "vtkOrientationMarkerWidget.h"
#include "vtkRenderWindowInteractor.h"
#include "vtkPolyDataMapper.h"
#include "vtkActor.h"
#include "vtkImageData.h"
#include "vtkLookupTable.h"
#include "vtkTexture.h"
#include "vtkPlaneSource.h"
int main( int argc, char *argv[] )
{
    if( argc < 2 ) return 1;
    vtkGDCMImageReader *reader = vtkGDCMImageReader::New();
    reader->SetFileName( argv[1] );
    //reader->FileLowerLeftOn();
    reader->Update();
    vtkImageFlip *flip = vtkImageFlip::New();
    #if (VTK_MAJOR_VERSION >= 6)
        flip->SetInputConnection(reader->GetOutputPort());
    #else
        flip->SetInput( reader->GetOutput() );
    #endif
    flip->SetFilteredAxis(0);
    flip->Update();
    vtkImageReslice *reslice = vtkImageReslice::New();
    //reslice->SetInput( reader->GetOutput() );
    #if (VTK_MAJOR_VERSION >= 6)
        reslice->SetInputConnection(flip->GetOutputPort());
    #else
        reslice->SetInput( flip->GetOutput() );
    #endif
    //reslice->SetResliceAxesDirectionCosines()
    reader->GetDirectionCosines()->Print(std::cout);
    vtkMatrix4x4 *invert = vtkMatrix4x4::New();
    invert->DeepCopy( reader->GetDirectionCosines() );
    invert->Invert();
    //reslice->SetResliceAxes( reader->GetDirectionCosines() );
    reslice->SetResliceAxes( invert );
    reslice->Update();
    vtkImageData* ima = reslice->GetOutput();
    vtkLookupTable* table = vtkLookupTable::New();
    table->SetNumberOfColors(1000);
    table->SetTableRange(0,1000);
    table->SetSaturationRange(0,0);
    table->SetHueRange(0,1);
    table->SetValueRange(0,1);
    table->SetAlphaRange(1,1);
    table->Build();
    // Texture
    vtkTexture* texture = vtkTexture::New();
    #if (VTK_MAJOR_VERSION >= 6)
        texture->SetInputData(ima);
    #else
        texture->SetInput(ima);
    #endif
    texture->InterpolateOn();
    texture->SetLookupTable(table);
    // PlaneSource
    vtkPlaneSource* plane = vtkPlaneSource::New();
    // PolyDataMapper
    vtkPolyDataMapper *planeMapper = vtkPolyDataMapper::New();
    #if (VTK_MAJOR_VERSION >= 6)
        planeMapper->SetInputConnection(plane->GetOutputPort());
    #else
        planeMapper->SetInput(plane->GetOutput());
    #endif
    // Actor
    vtkActor* planeActor = vtkActor::New();
    planeActor->SetTexture(texture);
    planeActor->SetMapper(planeMapper);
    planeActor->PickableOn();
    // Final rendering with simple interactor:
    vtkRenderer *ren = vtkRenderer::New();
    vtkRenderWindow *renwin = vtkRenderWindow::New();
    renwin->AddRenderer(ren);
    vtkRenderWindowInteractor *iren = vtkRenderWindowInteractor::New();

```

```

iren->SetRenderWindow(renwin);
ren->AddActor(planeActor);
ren->SetBackground(0,0,0.5);
// DICOM is RAH:
vtkAnnotatedCubeActor* cube = vtkAnnotatedCubeActor::New();
cube->SetXPlusFaceText ( "R" );
cube->SetXMinusFaceText ( "L" );
cube->SetYPlusFaceText ( "A" );
cube->SetYMinusFaceText ( "P" );
cube->SetZPlusFaceText ( "H" );
cube->SetZMinusFaceText ( "F" );
vtkAxesActor* axes2 = vtkAxesActor::New();
vtkTransform *transform = vtkTransform::New();
transform->Identity();
//reader->GetDirectionCosines()->Print(std::cout);
transform->Concatenate(invert);
//axes2->SetShaftTypeToCylinder();
axes2->SetUserTransform( transform );
cube->GetAssembly()->SetUserTransform( transform ); // cant get it to work
vtkPropAssembly* assembly = vtkPropAssembly::New();
assembly->AddPart( axes2 );
assembly->AddPart( cube );
vtkOrientationMarkerWidget* widget = vtkOrientationMarkerWidget::New();
widget->SetOrientationMarker( assembly );
widget->SetInteractor( iren );
widget->SetEnabled( 1 );
widget->InteractiveOff();
widget->InteractiveOn();
renwin->Render();
iren->Start();
// Clean up:
reader->Delete();
table->Delete();
texture->Delete();
plane->Delete();
planeMapper->Delete();
planeActor->Delete();
ren->Delete();
renwin->Delete();
iren->Delete();
return 0;
}

```

## 12.157 gdcmrntionplan.cxx

```

/*=====
Program: GDCM (Grassroots DICOM). A DICOM library

Copyright (c) 2006-2011 Mathieu Malaterre
All rights reserved.
See Copyright.txt or http://gdcms.sourceforge.net/Copyright.html for details.

This software is distributed WITHOUT ANY WARRANTY; without even
the implied warranty of MERCHANTABILITY or FITNESS FOR A PARTICULAR
PURPOSE. See the above copyright notice for more information.

=====*/
#include "vtkImageData.h"
#include "vtkPointData.h"
#include "vtkPolyData.h"
#include "vtkProperty.h"
#include "vtkPolyDataMapper.h"
#include "vtkActor.h"
#include "vtkRenderer.h"
#include "vtkCellArray.h"
#include "vtkPoints.h"
#include "vtkDoubleArray.h"
#include <vtkXMLImageDataWriter.h>
#include <vtkXMLPolyDataWriter.h>
#include <vtkRenderWindowInteractor.h>
#include <vtkImageColorViewer.h>
#include "gdcmsReader.h"
#include "gdcmsAttribute.h"
/*
This example is just for fun. We found a RT Ion Plan Storage and simply extracted the viz stuff for VTK

```

```

    RTIonPlanStorage, // 1.2.840.10008.5.1.4.1.1.481.8
*/
int main(int argc, char *argv[])
{
    if( argc < 3 )
    {
        std::cerr << argv[0] << " filename.dcm outfile.vti\n";
        return 1;
    }
    const char * filename = argv[1];
    const char * outfile = argv[2];
    const char * outfile2 = argv[3];
    gdcm::Reader reader;
    reader.SetFileName( filename );
    if( !reader.Read() )
    {
        return 1;
    }
    gdcm::MediaStorage ms;
    ms.SetFromFile( reader.GetFile() );
    if( ms != gdcm::MediaStorage::RTIonPlanStorage )
    {
        return 1;
    }
/*
(300a,03a2) SQ # u/1,1 Ion Beam Sequence
(fffe,e000) na (Item with undefined length)
(0008,1040) LO [Test] # 4,1 Institutional Department Name
(300a,00b2) SH (no value) # 0,1 Treatment Machine Name
(300a,00b3) CS [MU] # 2,1 Primary Dosimeter Unit
(300a,00c0) IS [1 ] # 2,1 Beam Number
(300a,00c2) LO [1 ] # 2,1 Beam Name
(300a,00c4) CS [STATIC] # 6,1 Beam Type
(300a,00c6) CS [PROTON] # 6,1 Radiation Type
(300a,00ce) CS [TREATMENT ] # 10,1 Treatment Delivery Type
(300a,00d0) IS [0 ] # 2,1 Number of Wedges
(300a,00e0) IS [1 ] # 2,1 Number of Compensators
(300a,00ed) IS [0 ] # 2,1 Number of Boli
(300a,00f0) IS [1 ] # 2,1 Number of Blocks
(300a,0110) IS [2 ] # 2,1 Number of Control Points
(300a,02ea) SQ # u/1,1 Ion Range Compensator Sequence
(fffe,e000) na (Item with undefined length)
(300a,00e1) SH [lucite] # 6,1 Material ID
(300a,00e4) IS [1 ] # 2,1 Compensator Number
(300a,00e5) SH [75hdhe5 ] # 8,1 Compensator ID
(300a,00e7) IS [35] # 2,1 Compensator Rows
(300a,00e8) IS [37] # 2,1 Compensator Columns
(300a,00e9) DS [3.679991\4.249288 ] # 18,2 Compensator Pixel Spacing
(300a,00ea) DS [-76.00\62.50] # 12,2 Compensator Position
(300a,00ec) DS
[52.13\52.13\52.13\53.18\54.04\54.04\47.11\40.06\40.06\38.79\34.87\33.28\33.28\33.28\33.28\35.43\35.43\34.54\34.54\34.71\36.71]
# 7618,1-n Compensator Thickness Data
(300a,02e0) CS [ABSENT] # 6,1 Compensator Divergence
(300a,02e1) CS [SOURCE_SIDE ] # 12,1 Compensator Mounting Position
(300a,02e4) FL 39.2 # 4,1 Isocenter to Compensator Tray Distance
(300a,02e5) FL 2.12 # 4,1 Compensator Column Offset
(300a,02e8) FL 4.76 # 4,1 Compensator Milling Tool Diameter
(fffe,e00d)
*/
const gdcm::DataSet& ds = reader.GetFile().GetDataSet();
gdcm::Tag tbeamsq(0x300a,0x03a2);
if( !ds.FindDataElement( tbeamsq ) )
{
    return 1;
}
const gdcm::DataElement &beamsq = ds.GetDataElement( tbeamsq );
//std::cout << beamsq << std::endl;
gdcm::SmartPointer<gdcm::SequenceOfItems> sqi = beamsq.GetValueAsSQ();
if( !sqi || !sqi->GetNumberOfItems() )
{
    return 1;
}
//for( unsigned int pd = 0; pd < sqi->GetNumberOfItems(); ++pd )
// {
//     //const gdcm::Item & item = sqi->GetItem(1); // Item start at #1
//     const gdcm::Item & item = sqi->GetItem(1); // Item start at #1
//     const gdcm::DataSet& nestedds = item.GetNestedDataSet();
//     //std::cout << nestedds << std::endl;
//     gdcm::Tag tcompensatorsq(0x300a,0x02ea);
//     if( !nestedds.FindDataElement( tcompensatorsq ) )
//     {

```

```

    return 1;
}
const gdcm::DataElement &compensatorsq = nesteddds.GetDataElement( tcompensatorsq );
//std::cout << compensatorsq << std::endl;
gdcm::SmartPointer<gdcm::SequenceOfItems> ssqi = compensatorsq.GetValueAsSQ();
const gdcm::Item & item2 = ssqi->GetItem(1); // Item start at #1
const gdcm::DataSet& nesteddds2 = item2.GetNestedDataSet();
//std::cout << nesteddds2 << std::endl;
gdcm::Tag tcompensatorthicknessdata(0x300a,0x00ec);
if( !nesteddds2.FindDataElement( tcompensatorthicknessdata ) )
{
    return 1;
}
const gdcm::DataElement &compensatorthicknessdata = nesteddds2.GetDataElement( tcompensatorthicknessdata );
// std::cout << compensatorthicknessdata << std::endl;
gdcm::Attribute<0x300a,0x00ec> at;
at.SetFromDataElement( compensatorthicknessdata );
const double* pts = at.GetValues();
// (300a,00e7) IS [35] # 2,1 Compensator Rows
gdcm::Attribute<0x300a,0x00e7> at1;
const gdcm::DataElement &compensatorrows = nesteddds2.GetDataElement( at1.GetTag() );
at1.SetFromDataElement( compensatorrows );
std::cout << at1.GetValue() << std::endl;
// (300a,00e8) IS [37] # 2,1 Compensator Columns
gdcm::Attribute<0x300a,0x00e8> at2;
const gdcm::DataElement &compensatorcols = nesteddds2.GetDataElement( at2.GetTag() );
at2.SetFromDataElement( compensatorcols );
std::cout << at2.GetValue() << std::endl;
// (300a,00e9) DS [3.679991\4.249288 ] # 18,2 Compensator Pixel Spacing
gdcm::Attribute<0x300a,0x00e9> at3;
const gdcm::DataElement &compensatorpixelspacing = nesteddds2.GetDataElement( at3.GetTag() );
at3.SetFromDataElement( compensatorpixelspacing );
std::cout << at3.GetValue(0) << std::endl;
// (300a,00ea) DS [-76.00\62.50] # 12,2 Compensator Position
gdcm::Attribute<0x300a,0x00ea> at4;
const gdcm::DataElement &compensatorposition = nesteddds2.GetDataElement( at4.GetTag() );
at4.SetFromDataElement( compensatorposition );
std::cout << at4.GetValue(0) << std::endl;
vtkDoubleArray *d = vtkDoubleArray::New();
d->SetArray( const_cast<double*>(pts) , at1.GetValue() * at2.GetValue() , 0 );
vtkImageData *img = vtkImageData::New();
img->Initialize();
img->SetDimensions( at2.GetValue(), at1.GetValue(), 1 );
//imgb->SetExtent(1, xdim, 1, ydim, 1, zdim);
#if (VTK_MAJOR_VERSION >= 6)
assert(0);
#else
img->SetScalarTypeToDouble();
#endif
img->SetSpacing( at3.GetValue(1), at3.GetValue(0), 1); // FIXME image is upside down
img->SetOrigin( at4.GetValue(0), at4.GetValue(1), 1);
#if (VTK_MAJOR_VERSION >= 6)
assert(0);
#else
img->SetNumberOfScalarComponents(1);
#endif
img->GetPointData()->SetScalars(d);
#if (VTK_MAJOR_VERSION >= 6)
#else
img->Update();
#endif
img->Print(std::cout);
vtkXMLImageDataWriter *writeb= vtkXMLImageDataWriter::New();
#if (VTK_MAJOR_VERSION >= 6)
writeb->SetInputData( img );
#else
writeb->SetInput( img );
#endif
writeb->SetFileName( outfilename );
writeb->Write();
/*
(300a,03a6) SQ # u/1,1 Ion Block Sequence
(fffe,e000) na (Item with undefined length)
(300a,00e1) SH [brass ] # 6,1 Material ID
(300a,00f7) FL 95.03 # 4,1 Isocenter to Block Tray Distance
(300a,00f8) CS [APERTURE] # 8,1 Block Type
(300a,00fa) CS [ABSENT] # 6,1 Block Divergence
(300a,00fb) CS [SOURCE_SIDE ] # 12,1 Block Mounting Position
(300a,00fc) IS [1 ] # 2,1 Block Number
(300a,0100) DS [50.00 ] # 6,1 Block Thickness
(300a,0104) IS [179 ] # 4,1 Block Number of Points

```

```

        (300a,0106) DS
        [1.7\50.0\14.3\50.0\16.7\49.4\18.7\48.2\19.4\47.7\20.1\47.1\21.0\47.0\22.3\47.0\23.7\46.8\25.7\46.2\27.0\45.6\27.2\45.4\28.
2\37.4\43.0\37.1\44.7\36] # 1934,2-2n Block Data
        (fffe,e00d)
        (fffe,e0dd)
*/
gdcmm::Tag tblocksq(0x300a,0x03a6);
if( !nestedds.FindDataElement( tblocksq ) )
{
    return 1;
}
const gdcmm::DataElement &tblocksq = nestedds.GetDataElement( tblocksq );
//std::cout << tblocksq << std::endl;
gdcmm::SmartPointer<gdcmm::SequenceOfItems> sssqi = tblocksq.GetValueAssSQ();
const gdcmm::Item &item3 = sssqi->GetItem(1); // Item start at #1
const gdcmm::DataSet& nestedds3 = item3.GetNestedDataSet();
gdcmm::Tag tblockdata(0x300a,0x0106);
if( !nestedds3.FindDataElement( tblockdata ) )
{
    return 1;
}
const gdcmm::DataElement &tblockdata = nestedds3.GetDataElement( tblockdata );
// std::cout << tblockdata << std::endl;
gdcmm::Attribute<0x300a,0x0106> at_;
at_.SetFromDataElement( tblockdata );
vtkDoubleArray *scalars = vtkDoubleArray::New();
scalars->SetNumberOfComponents(3);
gdcmm::Attribute<0x300a,0x0104> bnpts; // IS [179 ] # 4,1 Block Number
of Points
if( !nestedds3.FindDataElement( bnpts.GetTag() ) )
{
    return 1;
}
const gdcmm::DataElement &tblocknpts = nestedds3.GetDataElement( bnpts.GetTag() );
bnpts.SetFromDataElement( tblocknpts );
//std::cout << bnpts.GetValue() << std::endl;
vtkPolyData *output = vtkPolyData::New();
vtkPoints *newPts = vtkPoints::New();
vtkCellArray *polys = vtkCellArray::New();
const double *ptr = at_.GetValues();
//unsigned int npts = bnpts.GetNumberOfValues() / 2;
unsigned int npts = bnpts.GetValue();
vtkIdType *ptIds = new vtkIdType[npts];
for(unsigned int i = 0; i < npts; ++i)
{
    float x[3] = {};
    x[0] = (float)ptr[2*i+0];
    x[1] = (float)ptr[2*i+1];
    //x[2] = ptr[i+2];
    vtkIdType ptId = newPts->InsertNextPoint( x );
    //std::cout << x[0] << ", " << x[1] << ", " << x[2] << std::endl;
    ptIds[i] = ptId;
}
vtkIdType cellId = polys->InsertNextCell(npts, ptIds);
(void)cellId;
delete[] ptIds;
output->SetPoints(newPts);
newPts->Delete();
output->SetPolys(polys);
polys->Delete();
//output->GetCellData()->SetScalars(scalars);
//scalars->Delete();
#if (VTK_MAJOR_VERSION >= 6)
#else
    output->Update();
#endif
output->Print( std::cout );
// }
vtkRenderWindowInteractor *iren = vtkRenderWindowInteractor::New();
vtkImageColorViewer *viewer = vtkImageColorViewer::New();
#if (VTK_MAJOR_VERSION >= 6)
viewer->SetInputData(img);
#else
viewer->SetInput( img );
#endif
viewer->SetupInteractor( iren );
viewer->SetSize(600, 600);
viewer->GetRenderer()->ResetCameraClippingRange();
viewer->Render();
viewer->GetRenderer()->ResetCameraClippingRange();

```

```

    vtkPolyDataMapper *cubeMapper = vtkPolyDataMapper::New();
    //vtkPolyDataMapper2D* cubeMapper = vtkPolyDataMapper2D::New();
    #if (VTK_MAJOR_VERSION >= 6)
        cubeMapper->SetInputData( output );
    #else
        cubeMapper->SetInput( output );
    #endif
    cubeMapper->SetScalarRange(0,7);
    vtkActor *cubeActor = vtkActor::New();
    //vtkActor2D* cubeActor = vtkActor2D::New();
    cubeActor->SetMapper(cubeMapper);
    vtkProperty * property = cubeActor->GetProperty();
    property->SetRepresentationToWireframe();
    viewer->GetRenderer()->AddActor( cubeActor );
    vtkXMLPolyDataWriter *writec= vtkXMLPolyDataWriter::New();
    #if (VTK_MAJOR_VERSION >= 6)
        writec->SetInputData( output );
    #else
        writec->SetInput( output );
    #endif
    writec->SetFileName( outfilename2 );
    writec->Write( );
    iren->Initialize();
    iren->Start();
    return 0;
}

```

## 12.158 gdcmrtpan.cxx

```

/*=====
Program: GDCM (Grassroots DICOM). A DICOM library

Copyright (c) 2006-2011 Mathieu Malaterre
All rights reserved.
See Copyright.txt or http://gdcms.sourceforge.net/Copyright.html for details.

This software is distributed WITHOUT ANY WARRANTY; without even
the implied warranty of MERCHANTABILITY or FITNESS FOR A PARTICULAR
PURPOSE. See the above copyright notice for more information.

=====*/
#include "vtkImageData.h"
#include "vtkPointData.h"
#include "vtkPolyData.h"
#include "vtkProperty.h"
#include "vtkPolyDataMapper.h"
#include "vtkActor.h"
#include "vtkRenderer.h"
#include "vtkCellArray.h"
#include "vtkPoints.h"
#include "vtkDoubleArray.h"
#include <vtkXMLImageDataWriter.h>
#include <vtkRenderWindowInteractor.h>
#include <vtkImageColorViewer.h>
#include "gdcmReader.h"
#include "gdcmAttribute.h"
/*
This example is just for fun. We found a fake RT Ion Plan Storage and simply extracted the viz stuff for VTK
but this is rather a RT Plan storage
*/
int main(int argc, char *argv[])
{
    if( argc < 3 )
    {
        std::cerr << argv[0] << " filename.dcm outfile.vti\n";
        return 1;
    }
    const char * filename = argv[1];
    const char * outfilename = argv[2];
    gdcm::Reader reader;
    reader.SetFileName( filename );
    if( !reader.Read() )
    {
        return 1;
    }
    gdcm::MediaStorage ms;

```



```

ms.SetFromFile( reader.GetFile() );
if( ms != gdcmm::MediaStorage::RTIonPlanStorage )
{
    return 1;
}
/*
(300a,00b0) SQ # u/1,1 Beam Sequence
(fffe,e000) na (Item with undefined length)
(300a,00b2) SH (no value) # 0,1 Treatment Machine Name
(300a,00c0) IS [1 ] # 2,1 Beam Number
(300a,00c2) LO [1 ] # 2,1 Beam Name
(300a,00c4) CS [STATIC] # 6,1 Beam Type
(300a,00c6) CS [PROTON] # 6,1 Radiation Type
(300a,00ce) CS [TREATMENT ] # 10,1 Treatment Delivery Type
(300a,00e0) IS [1 ] # 2,1 Number of Compensators
(300a,00e3) SQ # u/1,1 Compensator Sequence
(fffe,e000) na (Item with undefined length)
(300a,00e1) SH [Lucite] # 6,1 Material ID
(300a,00e4) IS [1 ] # 2,1 Compensator Number
(300a,00e5) SH [75hdhe5 ] # 8,1 Compensator ID
(300a,00e7) IS [35] # 2,1 Compensator Rows
(300a,00e8) IS [37] # 2,1 Compensator Columns
(300a,00e9) DS [3.679991\4.249288 ] # 18,2 Compensator Pixel Spacing
(300a,00ea) DS [-76.00\62.50] # 12,2 Compensator Position
(300a,00ec) DS
[52.13\52.13\52.13\53.18\54.04\54.04\47.11\40.06\40.06\38.79\34.87\33.28\33.28\33.28\33.28\35.43\35.43\34.54\34.54\34.71\36.71]
# 7618,1-n Compensator Thickness Data
(300a,02e0) CS [ABSENT] # 6,1 Compensator Divergence
(300a,02e1) CS [SOURCE_SIDE ] # 12,1 Compensator Mounting Position
(fffe,e00d)
(fffe,e000) na (Item with undefined length)
(fffe,e00d)
(fffe,e0dd)
*/
const gdcmm::DataSet& ds = reader.GetFile().GetDataSet();
gdcmm::Tag tbeamsq(0x300a,0x00b0);
if( !ds.FindDataElement( tbeamsq ) )
{
    return 1;
}
const gdcmm::DataElement &beamsq = ds.GetDataElement( tbeamsq );
//std::cout << beamsq << std::endl;
gdcmm::SmartPointer<gdcmm::SequenceOfItems> sqi = beamsq.GetValueAsSQ();
if( !sqi || !sqi->GetNumberOfItems() )
{
    return 1;
}
//for( unsigned int pd = 0; pd < sqi->GetNumberOfItems(); ++pd )
// {
//const gdcmm::Item & item = sqi->GetItem(1); // Item start at #1
const gdcmm::Item & item = sqi->GetItem(2); // Item start at #1
const gdcmm::DataSet& nestedds = item.GetNestedDataSet();
//std::cout << nestedds << std::endl;
gdcmm::Tag tcompensatorsq(0x300a,0x00e3);
if( !nestedds.FindDataElement( tcompensatorsq ) )
{
    return 1;
}
const gdcmm::DataElement &compensatorsq = nestedds.GetDataElement( tcompensatorsq );
//std::cout << compensatorsq << std::endl;
gdcmm::SmartPointer<gdcmm::SequenceOfItems> ssqi = compensatorsq.GetValueAsSQ();
const gdcmm::Item & item2 = ssqi->GetItem(1); // Item start at #1
const gdcmm::DataSet& nestedds2 = item2.GetNestedDataSet();
//std::cout << nestedds2 << std::endl;
gdcmm::Tag tcompensatorthicknessdata(0x300a,0x00ec);
if( !nestedds2.FindDataElement( tcompensatorthicknessdata ) )
{
    return 1;
}
const gdcmm::DataElement &compensatorthicknessdata = nestedds2.GetDataElement( tcompensatorthicknessdata );
// std::cout << compensatorthicknessdata << std::endl;
gdcmm::Attribute<0x300a,0x00ec> at;
at.SetFromDataElement( compensatorthicknessdata );
const double* pts = at.GetValues();
// (300a,00e7) IS [35] # 2,1 Compensator Rows
gdcmm::Attribute<0x300a,0x00e7> at1;
const gdcmm::DataElement &compensatorrows = nestedds2.GetDataElement( at1.GetTag() );
at1.SetFromDataElement( compensatorrows );
std::cout << at1.GetValue() << std::endl;
// (300a,00e8) IS [37] # 2,1 Compensator Columns
gdcmm::Attribute<0x300a,0x00e8> at2;

```

```

const gdcM::DataElement &compensatorcols = nestedds2.GetDataElement( at2.GetTag() );
at2.SetFromDataElement( compensatorcols );
std::cout << at2.GetValue() << std::endl;
// (300a,00e9) DS [3.679991\4.249288 ] # 18,2 Compensator Pixel Spacing
gdcM::Attribute<0x300a,0x00e9> at3;
const gdcM::DataElement &compensatorpixelspacing = nestedds2.GetDataElement( at3.GetTag() );
at3.SetFromDataElement( compensatorpixelspacing );
std::cout << at3.GetValue(0) << std::endl;
// (300a,00ea) DS [-76.00\62.50] # 12,2 Compensator Position
gdcM::Attribute<0x300a,0x00ea> at4;
const gdcM::DataElement &compensatorposition = nestedds2.GetDataElement( at4.GetTag() );
at4.SetFromDataElement( compensatorposition );
std::cout << at4.GetValue(0) << std::endl;
vtkDoubleArray *d = vtkDoubleArray::New();
d->SetArray( const_cast<double*>(pts) , at1.GetValue() * at2.GetValue() , 0 );
vtkImageData *img = vtkImageData::New();
img->Initialize();
img->SetDimensions( at2.GetValue(), at1.GetValue(), 1 );
//imgb->SetExtent(1, xdim, 1, ydim, 1, zdim);
#if (VTK_MAJOR_VERSION >= 6)
assert(0);
#else
img->SetScalarTypeToDouble();
#endif
img->SetSpacing( at3.GetValue(1), at3.GetValue(0), 1); // FIXME image is upside down
img->SetOrigin( at4.GetValue(0), at4.GetValue(1), 1);
#if (VTK_MAJOR_VERSION >= 6)
assert(0);
#else
img->SetNumberOfScalarComponents(1);
#endif
img->GetPointData()->SetScalars(d);
vtkXMLImageDataWriter *writeb= vtkXMLImageDataWriter::New();
#if (VTK_MAJOR_VERSION >= 6)
writeb->SetInputData( img );
#else
writeb->SetInput( img );
#endif
writeb->SetFileName( outfilename );
writeb->Write( );
/*
(300a,00f4) SQ # u/1,1 Block Sequence
  (fffe,e000) na (Item with undefined length)
    (300a,00e1) SH [brass ] # 6,1 Material ID
    (300a,00f8) CS [APERTURE] # 8,1 Block Type
    (300a,00fa) CS [ABSENT] # 6,1 Block Divergence
    (300a,00fb) CS [SOURCE_SIDE ] # 12,1 Block Mounting Position
    (300a,00fc) IS [1 ] # 2,1 Block Number
    (300a,0100) DS [50.00 ] # 6,1 Block Thickness
    (300a,0104) IS [179 ] # 4,1 Block Number of Points
    (300a,0106) DS
    [1.7\50.0\14.3\50.0\16.7\49.4\18.7\48.2\19.4\47.7\20.1\47.1\21.0\47.0\22.3\47.0\23.7\46.8\25.7\46.2\27.0\45.6\27.2\45.4\28.
    # 1934,2-2n Block Data
  (fffe,e00d)
  (fffe,e000) na (Item with undefined length)
  (fffe,e00d)
(fffe,e0dd)
*/
gdcM::Tag tblocksq(0x300a,0x00f4);
if( !nestedds.FindDataElement( tblocksq ) )
{
return 1;
}
const gdcM::DataElement &tblocksq = nestedds.GetDataElement( tblocksq );
//std::cout << tblocksq << std::endl;
gdcM::SmartPointer<gdcM::SequenceOfItems> sssqi = tblocksq.GetValueAsSQ();
const gdcM::Item &item3 = sssqi->GetItem(1); // Item start at #1
const gdcM::DataSet& nestedds3 = item3.GetNestedDataSet();
gdcM::Tag tblockdata(0x300a,0x0106);
if( !nestedds3.FindDataElement( tblockdata ) )
{
return 1;
}
const gdcM::DataElement &tblockdata = nestedds3.GetDataElement( tblockdata );
// std::cout << tblockdata << std::endl;
gdcM::Attribute<0x300a,0x0106> at_;
at_.SetFromDataElement( tblockdata );
vtkDoubleArray *scalars = vtkDoubleArray::New();
scalars->SetNumberOfComponents(3);
gdcM::Attribute<0x300a,0x0104> bnpts; // IS [179 ] # 4,1 Block Number of Points
if( !nestedds3.FindDataElement( bnpts.GetTag() ) )

```

```

    {
        return 1;
    }
    const gdcms::DataElement &blocknpts = nesteddds3.GetDataElement( bnpts.GetTag() );
    bnpts.SetFromDataElement( blocknpts );
    std::cout << bnpts.GetValue() << std::endl;
    vtkPolyData *output = vtkPolyData::New();
    vtkPoints *newPts = vtkPoints::New();
    vtkCellArray *polys = vtkCellArray::New();
    const double *ptr = at_.GetValues();
    //unsigned int npts = bnpts.GetNumberOfValues() / 2;
    unsigned int npts = bnpts.GetValue();
    vtkIdType *ptIds = new vtkIdType[npts];
    for(unsigned int i = 0; i < npts; ++i)
    {
        float x[3] = {};
        x[0] = (float)ptr[2*i+0];
        x[1] = (float)ptr[2*i+1];
        //x[2] = ptr[i+2];
        vtkIdType ptId = newPts->InsertNextPoint( x );
        //std::cout << x[0] << ", " << x[1] << ", " << x[2] << std::endl;
        ptIds[i] = ptId;
    }
    vtkIdType cellId = polys->InsertNextCell(npts, ptIds);
    (void)cellId;
    delete[] ptIds;
    output->SetPoints(newPts);
    newPts->Delete();
    output->SetPolys(polys);
    polys->Delete();
    //output->GetCellData()->SetScalars(scalars);
    //scalars->Delete();
#if (VTK_MAJOR_VERSION >= 6)
#else
    output->Update();
#endif
    output->Print( std::cout );
    // }
    vtkRenderWindowInteractor *iren = vtkRenderWindowInteractor::New();
    vtkImageColorViewer *viewer = vtkImageColorViewer::New();
#if (VTK_MAJOR_VERSION >= 6)
    viewer->SetInputData(img);
#else
    viewer->SetInput(img);
#endif
    viewer->SetupInteractor(iren);
    viewer->SetSize(600, 600);
    viewer->Render();
    vtkPolyDataMapper *cubeMapper = vtkPolyDataMapper::New();
    //vtkPolyDataMapper2D* cubeMapper = vtkPolyDataMapper2D::New();
#if (VTK_MAJOR_VERSION >= 6)
    cubeMapper->SetInputData( output );
#else
    cubeMapper->SetInput( output );
#endif
    cubeMapper->SetScalarRange(0,7);
    vtkActor *cubeActor = vtkActor::New();
    //vtkActor2D* cubeActor = vtkActor2D::New();
    cubeActor->SetMapper(cubeMapper);
    vtkProperty *property = cubeActor->GetProperty();
    property->SetRepresentationToWireframe();
    viewer->GetRenderer()->AddActor( cubeActor );
    iren->Initialize();
    iren->Start();
    return 0;
}

```

## 12.159 gdcmscene.cxx

```

/*=====
Program: GDCM (Grassroots DICOM). A DICOM library

Copyright (c) 2006-2011 Mathieu Malaterre
All rights reserved.
See Copyright.txt or http://gdcms.sourceforge.net/Copyright.html for details.

```

This software is distributed WITHOUT ANY WARRANTY; without even the implied warranty of MERCHANTABILITY or FITNESS FOR A PARTICULAR PURPOSE. See the above copyright notice for more information.

```

=====*/
#include "vtkGDCMPolyDataReader.h"
// #include "vtkGDCMPolyDataWriter.h"
#include "vtkAppendPolyData.h"
#include "vtkPolyDataWriter.h"
#include "vtkPolyDataMapper.h"
#include "vtkPolyDataMapper2D.h"
#include "vtkActor2D.h"
#include "vtkRenderWindowInteractor.h"
#include "vtkRenderWindow.h"
#include "vtkRenderer.h"
#include "vtkCamera.h"
#include "vtkProperty.h"
#include "vtkProperty2D.h"
// gdcmDataExtra/gdcmNonImageData/exRT_Structure_Set_Storage.dcm
// gdcmDataExtra/gdcmNonImageData/RTSTRUCT_1.3.6.1.4.1.22213.1.1396.2.dcm
// gdcmDataExtra/gdcmNonImageData/RT/RTStruct.dcm
int main(int argc, char *argv[])
{
    if( argc < 2 )
    {
        std::cerr << argv[0] << " filename1.dcm\n";
        return 1;
    }
    const char * filename = argv[1];
    vtkGDCMPolyDataReader * reader = vtkGDCMPolyDataReader::New();
    reader->SetFileName( filename );
    reader->Update();
    // vtkGDCMPolyDataWriter * writer2 = vtkGDCMPolyDataWriter::New();
    // for(int num = 0; num < reader->GetNumberOfOutputPorts(); ++num )
    //     writer2->SetInput( num, reader->GetOutput( num ) );
    // writer2->SetFileName( "rtstruct.dcm" );
    // writer2->Write();
    // print reader output:
    reader->Print( std::cout );
    // print first output:
    reader->GetOutput()->Print( std::cout );
    vtkAppendPolyData *append = vtkAppendPolyData::New();
    int n = reader->GetNumberOfOutputPorts();
    for(int i = 0; i < n; ++i)
    {
#ifdef VTK_MAJOR_VERSION >= 6
        append->AddInputConnection( reader->GetOutputPort(i) );
#else
        append->AddInput( reader->GetOutput(i) );
#endif
    }
    vtkPolyDataWriter * writer = vtkPolyDataWriter::New();
#ifdef VTK_MAJOR_VERSION >= 6
    writer->SetInputConnection( reader->GetOutputPort() );
#else
    writer->SetInput( reader->GetOutput() );
#endif
    writer->SetFileName( "rtstruct.vtk" );
    //writer->Write();
    // Now we'll look at it.
    vtkPolyDataMapper *cubeMapper = vtkPolyDataMapper::New();
    //vtkPolyDataMapper2D* cubeMapper = vtkPolyDataMapper2D::New();
    //cubeMapper->SetInput( reader->GetOutput() );
#ifdef VTK_MAJOR_VERSION >= 6
    cubeMapper->SetInputConnection( append->GetOutputPort() );
#else
    cubeMapper->SetInput( append->GetOutput() );
#endif
    cubeMapper->SetScalarRange(0,7);
    vtkActor *cubeActor = vtkActor::New();
    //vtkActor2D* cubeActor = vtkActor2D::New();
    cubeActor->SetMapper(cubeMapper);
    vtkProperty * property = cubeActor->GetProperty();
    property->SetRepresentationToWireframe();
    //cubeActor->GetProperty()->SetColor(1, 0, 0);
    // The usual rendering stuff.
    // vtkCamera *camera = vtkCamera::New();
    // camera->SetPosition(1,1,1);
    // camera->SetFocalPoint(0,0,0);
    vtkRenderer *renderer = vtkRenderer::New();
    vtkRenderWindow *renWin = vtkRenderWindow::New();

```

```

    renWin->AddRenderer(renderer);
    vtkRenderWindowInteractor *iren = vtkRenderWindowInteractor::New();
    iren->SetRenderWindow(renWin);
    renderer->AddActor(cubeActor);
    //renderer->AddActor2D(cubeActor);
    //renderer->SetActiveCamera(camera);
    renderer->ResetCamera();
    renderer->SetBackground(1,1,1);
    renWin->SetSize(300,300);
    // interact with data
    renWin->Render();
    iren->Start();
    reader->Delete();
    append->Delete();
    cubeMapper->Delete();
    cubeActor->Delete();
    // camera->Delete();
    renderer->Delete();
    renWin->Delete();
    iren->Delete();
    writer->Delete();
    return 0;
}

```

## 12.160 gdcmttexture.cxx

```

/*=====
Program: GDCM (Grassroots DICOM). A DICOM library

Copyright (c) 2006-2011 Mathieu Malaterre
All rights reserved.
See Copyright.txt or http://gdcm.sourceforge.net/Copyright.html for details.

This software is distributed WITHOUT ANY WARRANTY; without even
the implied warranty of MERCHANTABILITY or FITNESS FOR A PARTICULAR
PURPOSE. See the above copyright notice for more information.

=====*/
#include "vtkGDCMImageReader.h"
#include "vtkRenderer.h"
#include "vtkAssembly.h"
#include "vtkRenderWindow.h"
#include "vtkAnnotatedCubeActor.h"
#include "vtkTransform.h"
#include "vtkAxesActor.h"
#include "vtkTextProperty.h"
#include "vtkCaptionActor2D.h"
#include "vtkPropAssembly.h"
#include "vtkOrientationMarkerWidget.h"
#include "vtkRenderWindowInteractor.h"
#include "vtkPolyDataMapper.h"
#include "vtkActor.h"
#include "vtkImageData.h"
#include "vtkLookupTable.h"
#include "vtkTexture.h"
#include "vtkPlaneSource.h"
int main( int argc, char *argv[] )
{
    if( argc < 2 ) return 1;
    vtkGDCMImageReader *reader = vtkGDCMImageReader::New();
    reader->SetFileName( argv[1] );
    reader->Update();
    vtkImageData* ima = reader->GetOutput();
    vtkLookupTable* table = vtkLookupTable::New();
    table->SetNumberOfColors(1000);
    table->SetTableRange(0,1000);
    table->SetSaturationRange(0,0);
    table->SetHueRange(0,1);
    table->SetValueRange(0,1);
    table->SetAlphaRange(1,1);
    table->Build();
    // Texture
    vtkTexture* texture = vtkTexture::New();
    #if (VTK_MAJOR_VERSION >= 6)
    texture->SetInputData(ima);
    #else

```

```

texture->SetInput(ima);
#endif
texture->InterpolateOn();
texture->SetLookupTable(table);
// PlaneSource
vtkPlaneSource* plane = vtkPlaneSource::New();
plane->SetOrigin(-0.5, -0.5, 0.0);
plane->SetPoint1(0.5, -0.5, 0.0);
plane->SetPoint2(-0.5, 0.5, 0.0);
// PolyDataMapper
vtkPolyDataMapper *planeMapper = vtkPolyDataMapper::New();
#if (VTK_MAJOR_VERSION >= 6)
planeMapper->SetInputConnection(plane->GetOutputPort());
#else
planeMapper->SetInput(plane->GetOutput());
#endif
// Actor
vtkActor* planeActor = vtkActor::New();
planeActor->SetTexture(texture);
planeActor->SetMapper(planeMapper);
planeActor->PickableOn();
// Final rendering with simple interactor:
vtkRenderer *ren = vtkRenderer::New();
vtkRenderWindow *renwin = vtkRenderWindow::New();
renwin->AddRenderer(ren);
vtkRenderWindowInteractor *iren = vtkRenderWindowInteractor::New();
iren->SetRenderWindow(renwin);
ren->AddActor(planeActor);
ren->SetBackground(0,0,0.5);
vtkAnnotatedCubeActor* cube = vtkAnnotatedCubeActor::New();
cube->SetXPlusFaceText("L");
cube->SetXMinusFaceText("R");
cube->SetYPlusFaceText("A");
cube->SetYMinusFaceText("P");
cube->SetZPlusFaceText("H");
cube->SetZMinusFaceText("F");
vtkAxesActor* axes2 = vtkAxesActor::New();
// simulate a left-handed coordinate system
//
vtkTransform *transform = vtkTransform::New();
transform->Identity();
//transform->RotateY(180);
reader->GetDirectionCosines()->Print(std::cout);
transform->Concatenate(reader->GetDirectionCosines());
//axes2->SetShaftTypeToCylinder();
axes2->SetUserTransform(transform);
//cube->SetUserTransform(transform); // cant get it to work
cube->GetAssembly()->SetUserTransform(transform); // cant get it to work
vtkPropAssembly* assembly = vtkPropAssembly::New();
assembly->AddPart(axes2);
assembly->AddPart(cube);
vtkOrientationMarkerWidget* widget = vtkOrientationMarkerWidget::New();
//widget->SetOutlineColor(0.9300, 0.5700, 0.1300);
widget->SetOrientationMarker(assembly);
widget->SetInteractor(iren);
//widget->SetViewport(0.0, 0.0, 0.4, 0.4);
widget->SetEnabled(1);
widget->InteractiveOff();
widget->InteractiveOn();
renwin->Render();
iren->Start();
// Clean up:
reader->Delete();
table->Delete();
texture->Delete();
plane->Delete();
planeMapper->Delete();
planeActor->Delete();
ren->Delete();
renwin->Delete();
iren->Delete();
return 0;
}

```

## 12.161 gdcmvolume.cxx

```

/*=====

```

Program: GDCM (Grassroots DICOM). A DICOM library

Copyright (c) 2006-2011 Mathieu Malaterre

All rights reserved.

See Copyright.txt or <http://gdcm.sourceforge.net/Copyright.html> for details.

This software is distributed WITHOUT ANY WARRANTY; without even the implied warranty of MERCHANTABILITY or FITNESS FOR A PARTICULAR PURPOSE. See the above copyright notice for more information.

```

=====*/
#include "vtkVersion.h"
#include "vtkGDCMImageReader.h"
#include "vtkPiecewiseFunction.h"
#include "vtkColorTransferFunction.h"
#include "vtkVolume.h"
#include "vtkVolumeProperty.h"
#if VTK_MAJOR_VERSION < 7
#include "vtkVolumeTextureMapper3D.h"
#endif
#include "vtkFixedPointVolumeRayCastMapper.h"
#include "vtkInteractorStyleTrackballCamera.h"
#include "vtkRenderer.h"
#include "vtkRenderWindow.h"
#include "vtkImageClip.h"
#include "vtkRenderWindowInteractor.h"
// gdcmvolume gdcmData/GE_DLX-8-MONO2-Multiframe-Jpeg_Lossless.dcm
int main(int argc, char *argv[])
{
    if( argc < 2 ) return 1;
    vtkGDCMImageReader *reader = vtkGDCMImageReader::New();
    reader->SetFileName( argv[1] );
    reader->Update();
    // Create the renderers, render window, and interactor
    vtkRenderWindow *renWin = vtkRenderWindow::New();
    vtkRenderWindowInteractor *iren = vtkRenderWindowInteractor::New();
    iren->SetRenderWindow(renWin);
    vtkRenderer *ren = vtkRenderer::New();
    renWin->AddRenderer(ren);
    // Create a transfer function mapping scalar value to opacity
    vtkPiecewiseFunction *oTFun = vtkPiecewiseFunction::New();
    //oTFun->AddSegment(0, 1.0, 256, 0.1);
    oTFun->AddSegment(0, 1.0, 240, 0.1);
    vtkColorTransferFunction *cTFun = vtkColorTransferFunction::New();
    cTFun->AddRGBPoint( 0, 1.0, 1.0, 1.0 );
    //cTFun->AddRGBPoint( 255, 1.0, 1.0, 1.0 );
    cTFun->AddRGBPoint( 240, 1.0, 1.0, 1.0 );
    // Need to crop to actually see minimum intensity
    vtkImageClip *clip = vtkImageClip::New();
    clip->SetInputConnection( reader->GetOutputPort() );
    clip->SetOutputWholeExtent(0,66,0,66,30,37);
    clip->ClipDataOn();
    vtkVolumeProperty *property = vtkVolumeProperty::New();
    property->SetScalarOpacity(oTFun);
    property->SetColor(cTFun);
    property->SetInterpolationTypeToLinear();
    vtkFixedPointVolumeRayCastMapper *mapper = vtkFixedPointVolumeRayCastMapper::New();
    mapper->SetBlendModeToMinimumIntensity();
    mapper->SetInputConnection( reader->GetOutputPort() );
    vtkVolume *volume = vtkVolume::New();
    volume->SetMapper(mapper);
    volume->SetProperty(property);
    ren->AddViewProp(volume);
    renWin->Render();
    {
        iren->Start();
    }
    volume->Delete();
    mapper->Delete();
    property->Delete();
    clip->Delete();
    cTFun->Delete();
    oTFun->Delete();
    reader->Delete();
    renWin->Delete();
    iren->Delete();
    ren->Delete();
    return 0;
}

```

## 12.162 offscreenimage.cxx

```

/*=====
Program: GDCM (Grassroots DICOM). A DICOM library

Copyright (c) 2006-2011 Mathieu Malaterre
All rights reserved.
See Copyright.txt or http://gdcm.sourceforge.net/Copyright.html for details.

This software is distributed WITHOUT ANY WARRANTY; without even
the implied warranty of MERCHANTABILITY or FITNESS FOR A PARTICULAR
PURPOSE. See the above copyright notice for more information.

=====*/
#include "vtkGDCMImageReader.h"
#include "vtkRenderWindow.h"
#include "vtkRenderer.h"
#include "vtkImageMapToWindowLevelColors.h"
#include "vtkImageActor.h"
#include "vtkPNGWriter.h"
#include "vtkWindowToImageFilter.h"
#include "vtkMedicalImageProperties.h"
int main(int argc, char *argv[])
{
    if( argc < 2 )
    {
        return 1;
    }
    const char *filename = argv[1];
    vtkGDCMImageReader *reader = vtkGDCMImageReader::New();
    reader->SetFileName( filename );
    reader->Update(); // important to read the window/level info
    vtkMedicalImageProperties *prop = reader->GetMedicalImageProperties();
    vtkRenderWindow *renWin = vtkRenderWindow::New();
    renWin->OffScreenRenderingOn();
    vtkRenderer *renderer = vtkRenderer::New();
    renWin->AddRenderer( renderer );
    vtkImageMapToWindowLevelColors *windowlevel = vtkImageMapToWindowLevelColors::New();
    #if (VTK_MAJOR_VERSION >= 6)
        windowlevel->SetInputConnection( reader->GetOutputPort() );
    #else
        windowlevel->SetInput( reader->GetOutput() );
    #endif
    unsigned int n = prop->GetNumberOfWindowLevelPresets();
    if( n )
    {
        // Take the first one by default:
        const double *wl = prop->GetNthWindowLevelPreset( 0 );
        windowlevel->SetWindow( wl[0] );
        windowlevel->SetLevel( wl[1] );
    }
    vtkImageActor *actor = vtkImageActor::New();
    #if (VTK_MAJOR_VERSION >= 6)
        actor->SetInputData( windowlevel->GetOutput() );
    #else
        actor->SetInput( windowlevel->GetOutput() );
    #endif
    renderer->AddActor( actor );
    renWin->Render();
    vtkWindowToImageFilter *w2if = vtkWindowToImageFilter::New();
    w2if->SetInput( renWin );
    vtkPNGWriter *wr = vtkPNGWriter::New();
    #if (VTK_MAJOR_VERSION >= 6)
        wr->SetInputConnection( w2if->GetOutputPort() );
    #else
        wr->SetInput( w2if->GetOutput() );
    #endif
    wr->SetFileName( "offscreenimage.png" );
    wr->Write();
    reader->Delete();
    renWin->Delete();
    renderer->Delete();
    windowlevel->Delete();
    actor->Delete();
    w2if->Delete();
    wr->Delete();
    return 0;
}

```



## 12.163 reslicesphere.cxx

```

/*=====
Program: GDCM (Grassroots DICOM). A DICOM library

Copyright (c) 2006-2011 Mathieu Malaterre
All rights reserved.
See Copyright.txt or http://gdcm.sourceforge.net/Copyright.html for details.

This software is distributed WITHOUT ANY WARRANTY; without even
the implied warranty of MERCHANTABILITY or FITNESS FOR A PARTICULAR
PURPOSE. See the above copyright notice for more information.

=====*/
//
// Load a DICOM series.
// Position a sphere within the volume.
// Allow the user to change between Axial, Sagittal, Coronal, and
// Oblique view of the images and move through the slices.
// The display should show the resliced image and the cross section
// of the sphere intersecting that plane.
//
/*
from Scott Johnson /Scott Johnson neuwave com/
to VTK /vtkusers vtk.org/
date Tue, May 11, 2010 at 7:01 PM
*/
#include <sstream>
#include <string>
#include <vtkDICOMImageReader.h>
#include <vtkStringArray.h>
#include <vtkDirectory.h>
#include <vtkImageThreshold.h>
#include <vtkImageShiftScale.h>
#include <vtkImageReslice.h>
#include <vtkRenderWindowInteractor.h>
#include <vtkImageViewer2.h>
#include <vtkSphereSource.h>
#include <vtkPolyDataMapper.h>
#include <vtkPlane.h>
#include <vtkCutter.h>
#include <vtkActor.h>
#include <vtkCommand.h>
#include <vtkSmartPointer.h>
#include <vtkMatrix4x4.h>
#include <vtkInteractorObserver.h>
#include <vtkProperty.h>
#include <vtkRenderer.h>
#include <vtkImageData.h>
#include <vtkImageActor.h>
#include "vtkTransformPolyDataFilter.h"
#include <vtkCamera.h>
#include <vtkMath.h>
#include <vtkTransform.h>
#include <vtkTextActor.h>
#include <vtkActor2D.h>
#include <vtkPolyDataMapper2D.h>
#include <vtkProperty2D.h>
#include <vtkGDCMImageReader.h>
#include <vtkImageChangeInformation.h>
#include "gdcmDirectory.h"
#include "gdcmTesting.h"
#include "gdcmIPPSorter.h"
// Change to match the path to find Raw_0.vti or provide
// the parameter when starting ResliceSphere.
const double sphereCenter[3]={74, 219, 70};
// Angles (0, 0, 0)
const double AxialMatrix[] = { 1.0, 0.0, 0.0, 0.0,
                              0.0, 1.0, 0.0, 0.0,
                              0.0, 0.0, 1.0, 0.0,
                              0.0, 0.0, 0.0, 1.0 };

// Angles (0, 90, 0)
const double SagittalMatrix[] = { 0.0, 0.0, 1.0, 0.0,
                                  0.0, 1.0, 0.0, 0.0,
                                  -1.0, 0.0, 0.0, 0.0,
                                  0.0, 0.0, 0.0, 1.0 };

// Angles (-90, 0, 0)
const double CoronalMatrix[] = { 1.0, 0.0, 0.0, 0.0,
                                 0.0, 0.0, 1.0, 0.0,

```

```

                                0.0, -1.0,  0.0,  0.0,
                                0.0,  0.0,  0.0,  1.0 };
// Angles (0, 90, 31)
const double ObliqueMatrix[] = { 0.0, -0.515038, 0.857167, 0.0,
                                0.0,  0.857167, 0.515038, 0.0,
                                -1.0,  0.0,  0.0,  0.0,
                                0.0,  0.0,  0.0,  1.0 };

class ResliceRender;
// Class to handle key press events.
class KeyCallback : public vtkCommand
{
public:
    static KeyCallback* New()
    {
        return new KeyCallback();
    }
    void Execute(vtkObject* caller, unsigned long eventId, void *calldata);
    void SetCallbackData(ResliceRender* reslice);
protected:
    ResliceRender* _reslice;
};
class ResliceRender
{
public:
    typedef enum _ORIENTATION
    {
        AXIAL = 0,
        SAGITTAL = 1,
        CORONAL = 2,
        OBLIQUE = 3
    } ORIENTATION;
    ResliceRender()
    {
        _orientation=AXIAL;
    }
    ~ResliceRender()
    {
        _transform->Delete();
        _reader->Delete();
        _reslice->Delete();
        _interactor->Delete();
        _imageView->Delete();
        _sphere->Delete();
        _sphereMapper->Delete();
        _sphereActor->Delete();
        _plane->Delete();
        _cutter->Delete();
        _polyTransform->Delete();
        _ROIMapper->Delete();
        _ROIActor->Delete();
        _annotation->Delete();
    }
    void CreatePipeline(const char* fileName)
    {
        vtkProperty2D* props;
        //_reader=vtkXMLImageDataReader::New();
        //_reader->SetFileName(fileName);
        //_reader->Update();
        //_reader=qzDICOMImageReader::New();
        _reader=vtkGDCMImageReader::New();
        //vtkDirectory *d = vtkDirectory::New();
        //d->Open(fileName);
        //d->Print( std::cout );
        gdcmm::Directory d;
        d.Load(fileName);
        gdcmm::Directory::FileNamesType const &files = d.GetFilesNames();
        gdcmm::IPPSorter s;
        s.SetComputeZSpacing( true );
        s.SetZSpacingTolerance( 1e-3 );
        bool b = s.Sort( files );
        if( !b )
        {
            std::cerr << "Failed to sort:" << fileName << std::endl;
            //return ;
        }
        //std::cout << "Sorting succeeded:" << std::endl;
        //s.Print( std::cout );
        //std::cout << "Found z-spacing:" << std::endl;
        //std::cout << s.GetZSpacing() << std::endl;
        double ippzspacing = s.GetZSpacing();
        const std::vector<std::string> &sorted = s.GetFilesNames();
    }
};

```

```

vtkStringArray *vtkfiles = vtkStringArray::New();
std::vector< std::string >::const_iterator it = sorted.begin();
for( ; it != sorted.end(); ++it)
{
    const std::string &f = *it;
    vtkfiles->InsertNextValue( f.c_str() );
}
    //_reader->SetDirectoryName(fileName);
    //_reader->SetFileNames( d->GetFiles() );
    _reader->SetFileNames( vtkfiles );
    _reader->Update();
const vtkFloatingPointType *spacing = _reader->GetOutput()->GetSpacing();
vtkImageChangeInformation *v16 = vtkImageChangeInformation::New();
#if (VTK_MAJOR_VERSION >= 6)
    v16->SetInputConnection( _reader->GetOutputPort() );
#else
    v16->SetInput( _reader->GetOutput() );
#endif
v16->SetOutputSpacing( spacing[0], spacing[1], ippszspacing );
v16->Update();
    _threshold=vtkImageThreshold::New();
    _threshold->ThresholdByUpper(-3024.0);
    _threshold->ReplaceOutOn();
    _threshold->SetOutValue(0.0);
    _threshold->SetInputConnection(v16->GetOutputPort());
    _shift=vtkImageShiftScale::New();
    _shift->SetShift(0);
    _shift->SetScale(1);
    _shift->SetInputConnection(_threshold->GetOutputPort());
    // Initialize the reslice with an axial orientation.
    vtkSmartPointer<vtkMatrix4x4> matrix =
        vtkSmartPointer<vtkMatrix4x4>::New();
    matrix->Identity();
    _transform = vtkTransform::New();
    _transform->SetMatrix(matrix);
    _reslice = vtkImageReslice::New();
    _reslice->SetOutputDimensionality(3);
    // PROBLEM:
    // The original intent was to connect the same transform
    // to the vtkImageReslice and vtkTransformPolyDataFilter,
    // but the resulting reslices appear different using the
    // vtkTransform as opposed to explicitly setting the
    // reslice axes via SetResliceAxes. Also, if the vtkTransform
    // is connected and orientated other than axial, the extents
    // don't seem to update resulting in VTK believing the slice
    // is out of range.
    //_reslice->SetResliceTransform(_transform);
    _reslice->SetResliceAxes(matrix);
    //_reslice->SetInputConnection(_reader->GetOutputPort());
    _reslice->SetInputConnection(_shift->GetOutputPort());
    // Create the sphere target shape.
    _sphere=vtkSphereSource::New();
    _sphere->SetRadius(7.0);
    _sphere->SetThetaResolution(16);
    _sphere->SetPhiResolution(16);
    _sphere->SetCenter(sphereCenter[0], sphereCenter[1], sphereCenter[2]);
    _sphereMapper=vtkPolyDataMapper::New();
    _sphereMapper->SetInputConnection(_sphere->GetOutputPort());
    _sphereActor=vtkActor::New();
    _sphereActor->SetMapper(_sphereMapper);
    _sphereActor->PickableOff();
    _sphereActor->GetProperty()->SetColor(1.0, 0.0, 0.0);
    _sphereActor->GetProperty()->SetEdgeColor(1.0, 0.0, 0.0);
    _sphereActor->GetProperty()->SetDiffuseColor(1.0, 0.0, 0.0);
    _sphereActor->SetVisibility(true);
    // Create the cutting pipeline.
    // This plane will be positioned in the original image coordinate system.
    _plane = vtkPlane::New();
    _plane->SetNormal(0.0, 0.0, 1.0);
    _cutter = vtkCutter::New();
    _cutter->SetInputConnection(_sphere->GetOutputPort());
    _cutter->SetCutFunction(_plane);
    _cutter->GenerateCutScalarsOn();
    _cutter->SetValue(0, 0.5);
    // The transform attached to _polyTransform should move the cut
    // ROI into the resliced coordinate system, which should be the
    // same as the coordinate system of the resliced images.
    // PROBLEM: It doesn't.
    _polyTransform = vtkTransformPolyDataFilter::New();
    _polyTransform->SetTransform(_transform);
    _polyTransform->SetInputConnection(_cutter->GetOutputPort());

```

```

    _ROIMapper = vtkPolyDataMapper2D::New();
    _ROIMapper->SetInputConnection(_polyTransform->GetOutputPort());
    vtkCoordinate* coordinate = vtkCoordinate::New();
    coordinate->SetCoordinateSystemToWorld();
    _ROIMapper->SetTransformCoordinate(coordinate);
    _ROIActor = vtkActor2D::New();
    _ROIActor->SetMapper(_ROIMapper);
    // Make sure the cut can be seen, especially the edges.
    props = _ROIActor->GetProperty();
    props->SetLineWidth(2);
    props->SetOpacity(1.0);
//    props->EdgeVisibilityOn();
//    props->SetDiffuse(0.8);
//    props->SetSpecular(0.3);
//    props->SetSpecularPower(20);
//    props->SetRepresentationToSurface();
//    props->SetDiffuseColor(1.0, 0.0, 0.0);
//    props->SetEdgeColor(1.0, 0.0, 0.0);
    props->SetColor(1.0, 0.0, 0.0);
    _interactor = vtkRenderWindowInteractor::New();
    // Create the image viewer and add the actor with the cut ROI.
    _imageView = vtkImageViewer2::New();
    _imageView->SetupInteractor(_interactor);
    _imageView->SetSize(400, 400);
    _imageView->SetColorWindow(1024);
    _imageView->SetColorLevel(800);
    _imageView->SetInputConnection(_reslice->GetOutputPort());
    _imageView->GetImageActor()->SetOpacity(0.5);
    _annotation = vtkTextActor::New();
    _annotation->SetTextScaleModeToViewport();
    _imageView->GetRenderer()->AddActor(_annotation);
    // Add the cut shape actor to the renderer.
    _imageView->GetRenderer()->AddActor(_ROIActor);
    // Set up the key handler.
    vtkSmartPointer<KeyCallback> callback = vtkSmartPointer<KeyCallback>::New();
    callback->SetCallbackData(this);
    _interactor->AddObserver(vtkCommand::KeyPressEvent, callback);
    _interactor->Initialize();
}
void Start()
{
    _interactor->Start();
}
void ResetOrientation()
{
    vtkSmartPointer<vtkMatrix4x4> matrix =
        vtkSmartPointer<vtkMatrix4x4>::New();
    matrix->Identity();
    SetOrientation(matrix);
}
// Make sure the orientation of the vtkImageReslice and
// vtkTransform are in sync.
void SetOrientation(vtkMatrix4x4* matrix)
{
    _reslice->SetResliceAxes(matrix);
    _reslice->Update();
    vtkMatrix4x4* inverse = vtkMatrix4x4::New();
    vtkMatrix4x4::Invert(matrix, inverse);
    _transform->SetMatrix(inverse);
    _transform->Update();
}
// Set the current slice of the current view.
void SetSlice(int slice)
{
    std::stringstream posString;
    double center[3];
    double spacing[3];
    double origin[3];
    double point[4];
    double newPoint[4];
    vtkImageData* imageData;
    int newSlice;
    // Try to make sure the extents of the reslice are updated.
    // PROBLEM: It doesn't seem to work when changing the orientation.
    imageData = vtkImageData::SafeDownCast(_reslice->GetOutput());
#if (VTK_MAJOR_VERSION >= 6)
    assert(0);
#else
    imageData->UpdateInformation();
#endif
    // Let vtkImageViewer2 handle the slice limits.

```

```

    _imageView->SetSlice(slice);
    newSlice=GetSlice();
    imageData->GetCenter(center);
    imageData->GetSpacing(spacing);
    imageData->GetOrigin(origin);
    // Compute the position of the center of the slice based on the
    // spacing of the slices. The resliced axis will always
    // be the "Z" axis.
    point[0]=center[0];
    point[1]=center[1];
    point[2]=(newSlice * spacing[2]) + origin[2];
    point[3]=1.0;
    // Convert the coordinate from the reslice coordinate system to the
    // original image coordinate system.
    // PROBLEM: Logically this seems like it should have been multiplied
    // by the inverse to translate from the resliced coordinate system to
    // the original coordinate system. However, multiplying by the inverse
    // sticks the plane in the wrong place completely. Using the original
    // matrix at least gets the Z coordinate right.
    vtkMatrix4x4* matrix=_reslice->GetResliceAxes();
    vtkSmartPointer<vtkMatrix4x4> inverse =
        vtkSmartPointer<vtkMatrix4x4>::New();
    vtkMatrix4x4::Invert(matrix, inverse);
    matrix->MultiplyPoint(point, newPoint);
    _plane->SetOrigin(newPoint[0], newPoint[1], newPoint[2]);
    // Annotate the image.
    posString << "Position: (" << newPoint[0] << ", " << newPoint[1]
        << ", " << newPoint[2] << ") Slice: " << newSlice;
    _annotation->SetInput(posString.str());
    _imageView->Render();
}
int GetSlice()
{
    return _imageView->GetSlice();
}
// Set the orientation of the view.
void SetOrientation(ResliceRender::ORIENTATION orientation)
{
    vtkCamera* camera=_imageView->GetRenderer()->GetActiveCamera();
    double spacing[3];
    double origin[3];
    double point[4];
    double newPoint[4];
    double initialPosition;
    double xDirCosine[3];
    double yDirCosine[3];
    double zDirCosine[3];
    double normal[3];
    vtkImageData* imageData;
    vtkSmartPointer<vtkMatrix4x4> matrix =
        vtkSmartPointer<vtkMatrix4x4>::New();
    _orientation=orientation;
    // Reset ViewUp
    camera->SetViewUp(0.0, 1.0, 0.0);
    // Compute the cut plane position to the input coordinate system.
    imageData=vtkImageData::SafeDownCast(_reslice->GetInput());
#if (VTK_MAJOR_VERSION >= 6)
    assert(0);
#else
    imageData->UpdateInformation();
#endif
    imageData->GetSpacing(spacing);
    imageData->GetOrigin(origin);
    point[0]=origin[0];
    point[1]=origin[1];
    point[2]=origin[2];
    point[3]=1.0;
    switch (_orientation)
    {
    case AXIAL:
        matrix->DeepCopy(AxialMatrix);
        initialPosition=sphereCenter[2];
        break;
    case CORONAL:
        matrix->DeepCopy(CoronalMatrix);
        initialPosition=sphereCenter[1];
        break;
    case SAGITTAL:
        matrix->DeepCopy(SagittalMatrix);
        initialPosition=sphereCenter[0];
        break;
    }
}

```

```

    case OBLIQUE:
        matrix->DeepCopy(ObliqueMatrix);
        initialPosition=sphereCenter[2];
        break;
    }
    // Move the origin from the original image coordinate system to the
    // resliced image coordinate system.
    matrix->MultiplyPoint(point, newPoint);
    matrix->SetElement(0, 3, newPoint[0]);
    matrix->SetElement(1, 3, newPoint[1]);
    matrix->SetElement(2, 3, newPoint[2]);
    ResetOrientation();
    SetOrientation(matrix);
    // Compute the cutting plane normal and set it.
    // PROBLEM: If the transformation is connected rather than
    // using SetResliceAxes, the Direction Cosines do not reflect
    // the orientation of the vtkImageReslice.
    _reslice->GetResliceAxesDirectionCosines(xDirCosine, yDirCosine,
                                             zDirCosine);

    vtkMath::Cross(xDirCosine, yDirCosine, normal);
    _plane->SetNormal(normal);
    // Set the extents and spacing of the reslice to account for
    // all of the data.
    _reslice->SetOutputExtentToDefault();
    _reslice->SetOutputSpacing(spacing[0], spacing[0], spacing[0]);
    // Force the vtkImageViewer2 to update.
    // PROBLEM: The whole extent does not seem to be set in time
    // for the first render. This results in an error because the
    // slice is positioned outside the old bounds.
#if (VTK_MAJOR_VERSION >= 6)
    _imageView->SetInputData(NULL);
#else
    _imageView->SetInput(NULL);
#endif
    _imageView->SetInputConnection(_reslice->GetOutputPort());
    _imageView->GetRenderer()->ResetCameraClippingRange();
    _imageView->GetRenderer()->ResetCamera();
    // Set the initial slice to be at the center of the sphere.
    // Divide by the spacing because this will be undone in SetSlice.
    SetSlice( (int)(initialPosition / spacing[0]));
}
vtkRenderWindowInteractor* GetInteractor()
{
    return _interactor;
}
protected:
    ORIENTATION                _orientation;
    //qzDICOMImageReader*       _reader;
    vtkGDCMImageReader*         _reader;
    vtkImageThreshold*          _threshold;
    vtkImageShiftScale*         _shift;
    vtkImageReslice*            _reslice;
    vtkRenderWindowInteractor*   _interactor;
    vtkImageViewer2*            _imageView;
    vtkSphereSource*            _sphere;
    vtkPolyDataMapper*           _sphereMapper;
    vtkActor*                   _sphereActor;
    vtkPlane*                   _plane;
    vtkCutter*                  _cutter;
    vtkTransform*               _transform;
    vtkTransformPolyDataFilter* _polyTransform;
    vtkPolyDataMapper2D*         _ROIMapper;
    vtkActor2D*                 _ROIActor;
    vtkTextActor*               _annotation;
};
// Catch KeyPress events.
// Up Arrow - increases the slice
// Down Arrow - decreases the slice
// 'A' - sets the view to Axial
// 'S' - sets the view to Sagittal
// 'C' - sets the view to Coronal
// 'O' - set the view to Oblique
void KeyCallback::Execute(vtkObject* caller, unsigned long eventId, void *calldata)
{
    (void)caller;
    (void)eventId;
    (void)calldata;
    std::string sym=_reslice->GetInteractor()->GetKeySym();
    if (!sym.compare("Up"))
    {
        _reslice->SetSlice(_reslice->GetSlice() + 1);
    }
}

```

```

    }
    else if (!sym.compare("Down"))
    {
        _reslice->SetSlice(_reslice->GetSlice() - 1);
    }
    else if ((!sym.compare("A")) || (!sym.compare("a")))
    {
        _reslice->SetOrientation(ResliceRender::AXIAL);
    }
    else if ((!sym.compare("C")) || (!sym.compare("c")))
    {
        _reslice->SetOrientation(ResliceRender::CORONAL);
    }
    else if ((!sym.compare("S")) || (!sym.compare("s")))
    {
        _reslice->SetOrientation(ResliceRender::SAGITTAL);
    }
    else if ((!sym.compare("O")) || (!sym.compare("o")))
    {
        _reslice->SetOrientation(ResliceRender::OBLIQUE);
    }
}
void KeyCallback::SetCallbackData(ResliceRender* reslice)
{
    _reslice=reslice;
}
// Usage: ResliceSphere [fileName]
int main(int argc, char *argv[])
{
    ResliceRender render;
    if (argc == 1)
    {
        const char *root = gdcm::Testing::GetDataExtraRoot();
        std::string dir3 = root;
        dir3 += "/gdcmSampleData/ForSeriesTesting/Dentist/images/";
        render.CreatePipeline(dir3.c_str());
    }
    else
    {
        render.CreatePipeline(argv[1]);
    }
    render.SetOrientation(ResliceRender::AXIAL);
    render.Start();
    return EXIT_SUCCESS;
}

```

## 12.164 rtstructapp.cxx

```

/*=====
Program: GDCM (Grassroots DICOM). A DICOM library

Copyright (c) 2006-2011 Mathieu Malaterre
All rights reserved.
See Copyright.txt or http://gdcm.sourceforge.net/Copyright.html for details.

This software is distributed WITHOUT ANY WARRANTY; without even
the implied warranty of MERCHANTABILITY or FITNESS FOR A PARTICULAR
PURPOSE. See the above copyright notice for more information.

=====*/
#include "vtkGDCMPolyDataReader.h"
#include "vtkGDCMPolyDataWriter.h"
#include "vtkPolyDataWriter.h"
#include "vtkPolyDataMapper.h"
#include "vtkPolyDataMapper2D.h"
#include "vtkActor2D.h"
#include "vtkRenderWindowInteractor.h"
#include "vtkMedicalImageProperties.h"
#include "vtkRenderWindow.h"
#include "vtkRenderer.h"
#include "vtkCamera.h"
#include "vtkProperty.h"
#include "vtkProperty2D.h"
#include "vtkAppendPolyData.h"
#include "vtkImageData.h"
/*

```

```

* Small example to read in a RTSTRUCT and write it out (displays it too).
*/
// gdcMDataExtra/gdcMNonImageData/exRT_Structure_Set_Storage.dcm
// gdcMDataExtra/gdcMNonImageData/RTSTRUCT_1.3.6.1.4.1.22213.1.1396.2.dcm
// gdcMDataExtra/gdcMNonImageData/RT/RTStruct.dcm
int main(int argc, char *argv[])
{
    if( argc < 3 )
    {
        std::cerr << argv[0] << " input.dcm output.dcm\n";
        return 1;
    }
    const char * filename = argv[1];
    const char * outfilename = argv[2];
    vtkGDCMPolyDataReader * reader = vtkGDCMPolyDataReader::New();
    reader->SetFileName( filename );
    reader->Update();
    //std::cout << reader->GetMedicalImageProperties()->GetStudyDate() << std::endl;
    vtkGDCMPolyDataWriter * writer = vtkGDCMPolyDataWriter::New();
    writer->SetNumberOfInputPorts( reader->GetNumberOfOutputPorts() );
    writer->SetFileName( outfilename );
    for(int num = 0; num < reader->GetNumberOfOutputPorts(); ++num )
    #if (VTK_MAJOR_VERSION >= 6)
        writer->SetInputConnection( num, reader->GetOutputPort(num) );
    #else
        writer->SetInput( num, reader->GetOutput(num) );
    #endif
    //doesn't look like the medical properties are actually written out
    writer->SetMedicalImageProperties( reader->GetMedicalImageProperties() );
    writer->SetRTStructSetProperties( reader->GetRTStructSetProperties() );
    writer->Write();
    // print reader output:
    reader->Print( std::cout );
    // print first output:
    reader->GetOutput()->Print( std::cout );
    vtkAppendPolyData *append = vtkAppendPolyData::New();
    int n = reader->GetNumberOfOutputPorts();
    for(int i = 0; i < n; ++i)
    {
    #if (VTK_MAJOR_VERSION >= 6)
        append->AddInputConnection( reader->GetOutputPort(i) );
    #else
        append->AddInput( reader->GetOutput(i) );
    #endif
    }
    // Now we'll look at it.
    vtkPolyDataMapper *cubeMapper = vtkPolyDataMapper::New();
    #if (VTK_MAJOR_VERSION >= 6)
        cubeMapper->SetInputConnection( append->GetOutputPort() );
    #else
        cubeMapper->SetInput( append->GetOutput() );
    #endif
    #endif
    cubeMapper->SetScalarRange(0,7);
    vtkActor *cubeActor = vtkActor::New();
    cubeActor->SetMapper( cubeMapper );
    vtkProperty * property = cubeActor->GetProperty();
    property->SetRepresentationToWireframe();
    vtkRenderer *renderer = vtkRenderer::New();
    vtkRenderWindow *renWin = vtkRenderWindow::New();
    renWin->AddRenderer( renderer );
    vtkRenderWindowInteractor *iren = vtkRenderWindowInteractor::New();
    iren->SetRenderWindow( renWin );
    renderer->AddActor( cubeActor );
    renderer->ResetCamera();
    renderer->SetBackground(1,1,1);
    renWin->SetSize(300,300);
    renWin->Render();
    iren->Start();
    reader->Delete();
    append->Delete();
    cubeMapper->Delete();
    cubeActor->Delete();
    renderer->Delete();
    renWin->Delete();
    iren->Delete();
    writer->Delete();
    return 0;
}

```



## 12.165 threadgdcm.cxx

```

/*=====
Program: GDCM (Grassroots DICOM). A DICOM library

Copyright (c) 2006-2011 Mathieu Malaterre
All rights reserved.
See Copyright.txt or http://gdcm.sourceforge.net/Copyright.html for details.

This software is distributed WITHOUT ANY WARRANTY; without even
the implied warranty of MERCHANTABILITY or FITNESS FOR A PARTICULAR
PURPOSE. See the above copyright notice for more information.

=====*/
#include "gdcmReader.h"
#include "gdcmImageReader.h"
#include "gdcmDirectory.h"
#include "gdcmSystem.h"
#include "vtkImageData.h"
#include "vtkStructuredPointsWriter.h"
#include <pthread.h>
struct threadparams
{
    const char **filenames;
    size_t nfiles;
    char *scalarpointer;
// TODO I should also pass in the dim of the reference image just in case
};
void *ReadFilesThread(void *voidparams)
{
    const threadparams *params = static_cast<const threadparams *> (voidparams);
    const size_t nfiles = params->nfiles;
    for(unsigned int file = 0; file < nfiles; ++file)
    {
        /*
        // TODO: update progress
        pthread_mutex_lock(&params->lock);
        //section critique
        ReadingProgress+=params->stepProgress;
        pthread_mutex_unlock(&params->lock);
        */
        const char *filename = params->filenames[file];
        //std::cerr << filename << std::endl;
        gdcm::ImageReader reader;
        reader.SetFileName( filename );
        try
        {
            {
                if( !reader.Read() )
                {
                    std::cerr << "Failed to read: " << filename << std::endl;
                    break;
                }
            }
        } catch( ... )
        {
            std::cerr << "Failed to read: " << filename << std::endl;
            break;
        }
        const gdcm::Image &image = reader.GetImage();
        unsigned long len = image.GetBufferLength();
        char * pointer = params->scalarpointer;
    #if 0
        char *tempimage = new char[len];
        image.GetBuffer(tempimage);
        memcpy(pointer + file*len, tempimage, len);
        delete[] tempimage;
    #else
        char *tempimage = pointer + file * len;
        image.GetBuffer(tempimage);
    #endif
    }
    return voidparams;
}
void ShowFileNames(const threadparams &params)
{
    std::cout << "start" << std::endl;
    for(unsigned int i = 0; i < params.nfiles; ++i)
    {
        const char *filename = params.filenames[i];

```

```

        std::cout << filename << std::endl;
    }
    std::cout << "end" << std::endl;
}
void ReadFiles(size_t nfiles, const char *filenames[])
{
    // \precondition: nfiles > 0
    assert( nfiles > 0 );
    const char *reference= filenames[0]; // take the first image as reference
    gdcm::ImageReader reader;
    reader.SetFileName( reference );
    if( !reader.Read() )
    {
        // That would be very bad...
        assert(0);
    }
    const gdcm::Image &image = reader.GetImage();
    gdcm::PixelFormat pixeltype = image.GetPixelFormat();
    unsigned long len = image.GetBufferLength();
    const unsigned int *dims = image.GetDimensions();
    unsigned short pixelsize = pixeltype.GetPixelSize();
    (void)pixelsize;
    assert( image.GetNumberOfDimensions() == 2 );
    vtkImageData *output = vtkImageData::New();
    output->SetDimensions(dims[0], dims[1], (int)nfiles);
    #if (VTK_MAJOR_VERSION >= 6)
    int numscal = pixeltype.GetSamplesPerPixel();
    switch( pixeltype )
    {
        case gdcm::PixelFormat::INT8:
            output->AllocateScalars( VTK_SIGNED_CHAR, numscal );
            break;
        case gdcm::PixelFormat::UINT8:
            output->AllocateScalars( VTK_UNSIGNED_CHAR, numscal );
            break;
        case gdcm::PixelFormat::INT16:
            output->AllocateScalars( VTK_SHORT, numscal );
            break;
        case gdcm::PixelFormat::UINT16:
            output->AllocateScalars( VTK_UNSIGNED_SHORT, numscal );
            break;
        case gdcm::PixelFormat::INT32:
            output->AllocateScalars( VTK_INT, numscal );
            break;
        case gdcm::PixelFormat::UINT32:
            output->AllocateScalars( VTK_UNSIGNED_INT, numscal );
            break;
        default:
            assert(0);
    }
    #else
    switch( pixeltype )
    {
        case gdcm::PixelFormat::INT8:
            #if (VTK_MAJOR_VERSION >= 5) || ( VTK_MAJOR_VERSION == 4 && VTK_MINOR_VERSION > 5 )
            output->SetScalarType ( VTK_SIGNED_CHAR );
            #else
            output->SetScalarType ( VTK_CHAR );
            #endif
            break;
        case gdcm::PixelFormat::UINT8:
            output->SetScalarType ( VTK_UNSIGNED_CHAR );
            break;
        case gdcm::PixelFormat::INT16:
            output->SetScalarType ( VTK_SHORT );
            break;
        case gdcm::PixelFormat::UINT16:
            output->SetScalarType ( VTK_UNSIGNED_SHORT );
            break;
        case gdcm::PixelFormat::INT32:
            output->SetScalarType ( VTK_INT );
            break;
        case gdcm::PixelFormat::UINT32:
            output->SetScalarType ( VTK_UNSIGNED_INT );
            break;
        default:
            assert(0);
    }
    output->SetNumberOfScalarComponents ( pixeltype.GetSamplesPerPixel() );
    output->AllocateScalars();
    #endif
}

```

```

char * scalarpointer = static_cast<char*>(output->GetScalarPointer());
const unsigned int nthreads = 4;
threadparams params[nthreads];
//pthread_mutex_t lock;
//pthread_mutex_init(&lock, NULL);
pthread_t *pthread = new pthread_t[nthreads];
// There is nfiles, and nThreads
assert( nfiles > nthreads );
const size_t partition = nfiles / nthreads;
for (unsigned int thread=0; thread < nthreads; ++thread)
{
    params[thread].filenames = filenames + thread * partition;
    params[thread].nfiles = partition;
    if( thread == nthreads - 1 )
    {
        // There is slightly more files to process in this thread:
        params[thread].nfiles += nfiles % nthreads;
    }
    assert( thread * partition < nfiles );
    params[thread].scalarpointer = scalarpointer + thread * partition * len;
    //assert( params[thread].scalarpointer < scalarpointer + 2 * dims[0] * dims[1] * dims[2] );
    // start thread:
    int res = pthread_create( &pthread[thread], NULL, ReadFilesThread, &params[thread]);
    if( res )
    {
        std::cerr << "Unable to start a new thread, pthread returned: " << res << std::endl;
        assert(0);
    }
    //ShowFileNames(params[thread]);
}
// DEBUG
size_t total = 0;
for (unsigned int thread=0; thread < nthreads; ++thread)
{
    total += params[thread].nfiles;
}
assert( total == nfiles );
// END DEBUG
for (unsigned int thread=0;thread<nthreads;thread++)
{
    pthread_join( pthread[thread], NULL);
}
delete[] pthread;
//pthread_mutex_destroy(&lock);
// For some reason writing down the file is painfully slow...
vtkStructuredPointsWriter *writer = vtkStructuredPointsWriter::New();
#if (VTK_MAJOR_VERSION >= 6)
    writer->SetInputData( output );
#else
    writer->SetInput( output );
#endif
writer->SetFileName( "/tmp/threadgdc.vtk" );
writer->SetFileTypeToBinary();
//writer->Write();
writer->Delete();
//output->Print( std::cout );
output->Delete();
}
int main(int argc, char *argv[])
{
    if( argc < 2 )
    {
        std::cerr << argv[0] << " [directory|list of filenames]\n";
        return 1;
    }
    // Check if user pass in a single directory
    if( argc == 2 && gdc::System::FileIsDirectory( argv[1] ) )
    {
        gdc::Directory d;
        d.Load( argv[1] );
        gdc::Directory::FileNamesType l = d.GetFilesNames();
        const size_t nfiles = l.size();
        const char **filenames = new const char* [ nfiles ];
        for(unsigned int i = 0; i < nfiles; ++i)
        {
            filenames[i] = l[i].c_str();
        }
        ReadFiles(nfiles, filenames);
        delete[] filenames;
    }
    else

```

```

    {
    // Simply copy all filenames into the vector:
    const char **filenames = const_cast<const char**>(argv+1);
    const size_t nfiles = argc - 1;
    ReadFiles(nfiles, filenames);
    }
return 0;
}

```

## 12.166 AWTMedical3.java

```

/*=====
Program: GDCM (Grassroots DICOM). A DICOM library

Copyright (c) 2006-2011 Mathieu Malaterre
All rights reserved.
See Copyright.txt or http://gdcm.sourceforge.net/Copyright.html for details.

This software is distributed WITHOUT ANY WARRANTY; without even
the implied warranty of MERCHANTABILITY or FITNESS FOR A PARTICULAR
PURPOSE. See the above copyright notice for more information.

=====*/
package examples;
import vtk.*;
//import gdcm.*;
import vtk.util.VtkPanelContainer;
import vtk.util.VtkPanelUtil;
import vtk.util.VtkUtil;
import java.util.ArrayList;
import javax.swing.*;
import java.awt.*;
import java.io.File;
public class AWTMedical3 extends JComponent implements VtkPanelContainer {
    private VtkPanel renWin;
    vtkImageData ReadDataFile(File inSelectedFile){
        vtkImageData outImageData = null;
        Directory theDir = new Directory();
        String theInputDirectory = inSelectedFile.getPath();
        theDir.Load(theInputDirectory);
        Scanner theScanner = new Scanner();
        Tag theStudyTag = new Tag(0x0020,0x000d);
        Tag theSeriesTag = new Tag(0x0020,0x000e);
        theScanner.AddTag(theStudyTag); //get studies,
        theScanner.AddTag(theSeriesTag); //get studies,
        theScanner.Scan(theDir.GetFilesNames());
        FilenamesType theStudyValues = theScanner.GetOrderedValues(theStudyTag);
        long theNumStudies = theStudyValues.size();
        //for now, take the first study, and nothing else.
        //and the return is actually not FilenamesType, just a
        //vector of strings
        if (theNumStudies != 1)
            return outImageData;
        String theStudyVal = theStudyValues.get(0);
        //now, get all the values from the scanner that are in that
        //study, then from that get their different series
        FilenamesType theFileNames =
            theScanner.GetAllFilenamesFromTagToValue(theStudyTag, theStudyVal);
        //from that set of filenames, isolate individual series
        //conclude that singleton series = RT struct (can do further
        //checking for things like MIPs and the like)
        //and multiple series entries = volumetric data
        theScanner.Scan(theFileNames);
        FilenamesType theSeriesValues = theScanner.GetOrderedValues(theSeriesTag);
        String studyUID = theScanner.GetValue(theScanner.GetFilesNames().get(0), theStudyTag);
        long theNumSeries = theSeriesValues.size();
        for (int i = 0; i < theNumSeries; i++) {
            FilenamesType theSeriesFiles =
                theScanner.GetAllFilenamesFromTagToValue(theSeriesTag, theSeriesValues.get(i));
            long theNumFilesInSeries = theSeriesFiles.size();
            if (theNumFilesInSeries > 1) { //assume it's CT or volumetric data
                //for now, assume a single volume
                //could have multiples, like PET and CT
                IPPSorter sorter = new IPPSorter();
                sorter.SetComputeZSpacing(true);
                sorter.SetZSpacingTolerance(0.001);
            }
        }
    }
}

```

```
        Boolean sorted = sorter.Sort(theSeriesFiles);
        if (!sorted){
            //need some better way to handle failures here
            return outImageData;
        }
        FilenamesType sortedFT = sorter.GetFilesNames();
        long theSize = sortedFT.size();
        vtkStringArray sa = new vtkStringArray();
        ArrayList<String> theStrings = new ArrayList<String>();
        vtkGDCMImageReader gdcMReader = new vtkGDCMImageReader();
        for (int j = 0; j < theSize; j++) {
            String theFileName = sortedFT.get(j);
            if (gdcMReader.CanReadFile(theFileName) > 0){
                theStrings.add(theFileName);
                sa.InsertNextValue(theFileName);
            } else {
                //this is a busted series
                //need some more appropriate error here
                return outImageData;
            }
        }
        gdcMReader.SetFileNames(sa);
        gdcMReader.Update();
        outImageData = gdcMReader.GetOutput();//the zeroth output should be the image
    }
}
String theImageInfo = "";
if (outImageData != null){
    theImageInfo = outImageData.Print();
}
return outImageData;
}
//this function is a rewrite of Medical3 to see if data can
//be loaded via gdcM easily
public AWTMedical3(File inFile) {
    // Create the buttons.
    renWin = new vtkPanel();
    vtkImageData theImageData = ReadDataFile(inFile);
    // An isosurface, or contour value of 500 is known to correspond to the
    // skin of the patient. Once generated, a vtkPolyDataNormals filter is
    // is used to create normals for smooth surface shading during rendering.
    // The triangle stripper is used to create triangle strips from the
    // isosurface these render much faster on some systems.
    vtkContourFilter skinExtractor = new vtkContourFilter();
    skinExtractor.SetInput(theImageData);
    skinExtractor.SetValue(0, 500);
    vtkPolyDataNormals skinNormals = new vtkPolyDataNormals();
    skinNormals.SetInput(skinExtractor.GetOutput());
    skinNormals.SetFeatureAngle(60.0);
    //      vtkStripper skinStripper = new vtkStripper();
    //      skinStripper.SetInput(skinNormals.GetOutput());
    vtkPolyDataMapper skinMapper = new vtkPolyDataMapper();
    skinMapper.SetInput(skinNormals.GetOutput());
    skinMapper.ScalarVisibilityOff();
    vtkActor skin = new vtkActor();
    skin.SetMapper(skinMapper);
    skin.GetProperty().SetDiffuseColor(1, .49, .25);
    skin.GetProperty().SetSpecular(.3);
    skin.GetProperty().SetSpecularPower(20);
    // An isosurface, or contour value of 1150 is known to correspond to the
    // skin of the patient. Once generated, a vtkPolyDataNormals filter is
    // is used to create normals for smooth surface shading during rendering.
    // The triangle stripper is used to create triangle strips from the
    // isosurface these render much faster on some systems.
    vtkContourFilter boneExtractor = new vtkContourFilter();
    boneExtractor.SetInput(theImageData);
    boneExtractor.SetValue(0, 1150);
    vtkPolyDataNormals boneNormals = new vtkPolyDataNormals();
    boneNormals.SetInput(boneExtractor.GetOutput());
    boneNormals.SetFeatureAngle(60.0);
    vtkStripper boneStripper = new vtkStripper();
    boneStripper.SetInput(boneNormals.GetOutput());
    vtkPolyDataMapper boneMapper = new vtkPolyDataMapper();
    boneMapper.SetInput(boneStripper.GetOutput());
    boneMapper.ScalarVisibilityOff();
    vtkActor bone = new vtkActor();
    bone.SetMapper(boneMapper);
    bone.GetProperty().SetDiffuseColor(1, 1, .9412);
    // An outline provides context around the data.
    vtkOutlineFilter outlineData = new vtkOutlineFilter();
    outlineData.SetInput(theImageData);
```

```

vtkPolyDataMapper mapOutline = new vtkPolyDataMapper();
mapOutline.SetInput(outlineData.GetOutput());
vtkActor outline = new vtkActor();
outline.SetMapper(mapOutline);
outline.GetProperty().SetColor(0, 0, 0);
// Now we are creating three orthogonal planes passing through the
// volume. Each plane uses a different texture map and therefore has
// different coloration.
// Start by creating a black/white lookup table.
vtkLookupTable bwLut = new vtkLookupTable();
bwLut.SetTableRange(0, 2000);
bwLut.SetSaturationRange(0, 0);
bwLut.SetHueRange(0, 0);
bwLut.SetValueRange(0, 1);
bwLut.Build();
// Now create a lookup table that consists of the full hue circle (from
// HSV);.
vtkLookupTable hueLut = new vtkLookupTable();
hueLut.SetTableRange(0, 2000);
hueLut.SetHueRange(0, 1);
hueLut.SetSaturationRange(1, 1);
hueLut.SetValueRange(1, 1);
hueLut.Build();
// Finally, create a lookup table with a single hue but having a range
// in the saturation of the hue.
vtkLookupTable satLut = new vtkLookupTable();
satLut.SetTableRange(0, 2000);
satLut.SetHueRange(.6, .6);
satLut.SetSaturationRange(0, 1);
satLut.SetValueRange(1, 1);
satLut.Build();
// Create the first of the three planes. The filter vtkImageMapToColors
// maps the data through the corresponding lookup table created above.
// The vtkImageActor is a type of vtkProp and conveniently displays an
// image on a single quadrilateral plane. It does this using texture
// mapping and as a result is quite fast. (Note: the input image has to
// be unsigned char values, which the vtkImageMapToColors produces.);
// Note also that by specifying the DisplayExtent, the pipeline
// requests data of this extent and the vtkImageMapToColors only
// processes a slice of data.
vtkImageMapToColors saggitalColors = new vtkImageMapToColors();
saggitalColors.SetInput(theImageData);
saggitalColors.SetLookupTable(bwLut);
vtkImageActor saggital = new vtkImageActor();
saggital.SetInput(saggitalColors.GetOutput());
saggital.SetDisplayExtent(32, 32, 0, 63, 0, 92);
// Create the second (axial); plane of the three planes. We use the same
// approach as before except that the extent differs.
vtkImageMapToColors axialColors = new vtkImageMapToColors();
axialColors.SetInput(theImageData);
axialColors.SetLookupTable(hueLut);
vtkImageActor axial = new vtkImageActor();
axial.SetInput(axialColors.GetOutput());
axial.SetDisplayExtent(0, 63, 0, 63, 46, 46);
// Create the third (coronal); plane of the three planes. We use the same
// approach as before except that the extent differs.
vtkImageMapToColors coronalColors = new vtkImageMapToColors();
coronalColors.SetInput(theImageData);
coronalColors.SetLookupTable(satLut);
vtkImageActor coronal = new vtkImageActor();
coronal.SetInput(coronalColors.GetOutput());
coronal.SetDisplayExtent(0, 63, 32, 32, 0, 92);
// It is convenient to create an initial view of the data. The FocalPoint
// and Position form a vector direction. Later on (ResetCamera() method)
// this vector is used to position the camera to look at the data in
// this direction.
vtkCamera aCamera = new vtkCamera();
aCamera.SetViewUp(0, 0, -1);
aCamera.SetPosition(0, 1, 0);
aCamera.SetFocalPoint(0, 0, 0);
aCamera.ComputeViewPlaneNormal();
// Actors are added to the renderer. An initial camera view is created.
// The Dolly() method moves the camera towards the FocalPoint,
// thereby enlarging the image.
renWin.GetRenderer().AddActor(saggital);
renWin.GetRenderer().AddActor(axial);
renWin.GetRenderer().AddActor(coronal);
renWin.GetRenderer().AddActor(outline);
renWin.GetRenderer().AddActor(skin);
renWin.GetRenderer().AddActor(bone);
// Turn off bone for this example.

```

```

bone.VisibilityOff();
// Set skin to semi-transparent.
skin.GetProperty().SetOpacity(0.5);
// An initial camera view is created. The Dolly() method moves
// the camera towards the FocalPoint, thereby enlarging the image.
renWin.GetRenderer().SetActiveCamera(aCamera);
renWin.GetRenderer().ResetCamera();
aCamera.Dolly(1.5);
// Set a background color for the renderer and set the size of the
// render window (expressed in pixels).
renWin.GetRenderer().SetBackground(1, 1, 1);
VtkPanelUtil.setSize(renWin, 640, 480);
// Note that when camera movement occurs (as it does in the Dolly()
// method), the clipping planes often need adjusting. Clipping planes
// consist of two planes: near and far along the view direction. The
// near plane clips out objects in front of the plane the far plane
// clips out objects behind the plane. This way only what is drawn
// between the planes is actually rendered.
renWin.GetRenderer().ResetCameraClippingRange();
// Setup panel
setLayout(new BorderLayout());
add(renWin, BorderLayout.CENTER);
}
public vtkPanel getRenWin() {
    return renWin;
}
public static void main(String s[]) {
    if (s.length == 0){
        return; //need a filename here
    }
    File theFile = new File(s[0]);
    //File theFile = new
        File("/Users/mmroden/Documents/MVSDownloadDirectory/Documents/1.2.840.113704.1.111.3384.1271766367.5/");
    AWTMedical3 panel = new AWTMedical3(theFile);
    JFrame frame = new JFrame("AWTMedical3");
    frame.setDefaultCloseOperation(JFrame.EXIT_ON_CLOSE);
    frame.getContentPane().add("Center", panel);
    frame.pack();
    frame.setVisible(true);
}
}

```

## 12.167 HelloVTKWorld.java

```

/*=====
Program: GDCM (Grassroots DICOM). A DICOM library

Copyright (c) 2006-2011 Mathieu Malaterre
All rights reserved.
See Copyright.txt or http://gdcm.sourceforge.net/Copyright.html for details.

This software is distributed WITHOUT ANY WARRANTY; without even
the implied warranty of MERCHANTABILITY or FITNESS FOR A PARTICULAR
PURPOSE. See the above copyright notice for more information.

=====*/
// We are required to call the package 'vtk' eventhough I (MM) would have preferred
// an import statement along the line of:
// import vtkgdcm.*;
import vtk.*;
/*
 * Compilation:
 * CLASSPATH=vtkgdcm.jar:/usr/share/java/vtk.jar javac HelloVTKWorld.java
 *
 * Usage:
 * LD_LIBRARY_PATH=/usr/lib/jvm/java-6-openjdk/jre/lib/amd64/xawt:/usr/lib/jni:.
 * CLASSPATH=/usr/share/java/vtk.jar:vtkgdcm.jar:gdcm.jar:. java HelloVTKWorld gdcmData/012345.002.050.dcm
 * bla.dcm
 */
public class HelloVTKWorld
{
    static {
        System.loadLibrary("vtkCommonJava");
        System.loadLibrary("vtkFilteringJava");
        System.loadLibrary("vtkIOJava");
    }
}

```

```

System.loadLibrary("vtkImagingJava");
System.loadLibrary("vtkGraphicsJava");
System.loadLibrary("vtkgdcmJava");
try {
    System.loadLibrary("vtkRenderingJava");
} catch (Throwable e) {
    System.out.println("cannot load vtkHybrid, skipping...");
}
try {
    System.loadLibrary("vtkHybridJava");
} catch (Throwable e) {
    System.out.println("cannot load vtkHybrid, skipping...");
}
try {
    System.loadLibrary("vtkVolumeRenderingJava");
} catch (Throwable e) {
    System.out.println("cannot load vtkVolumeRendering, skipping...");
}
}
public static void main(String[] args)
{
    String filename = args[0];
    vtkGDCMImageReader reader = new vtkGDCMImageReader();
    reader.SetFileName( filename );
    reader.Update();
    vtkMedicalImageProperties prop = reader.GetMedicalImageProperties();
    System.out.println( prop.GetPatientName() ); //
//    if( reader.GetImageFormat() == vtkgdcm.vtkgdcm.VTK_LUMINANCE ) // MONOCHROME2
//    {
//        System.out.println( "Image is MONOCHROME2" ); //
//    }
// Just for fun, invert the direction cosines, output should reflect that:
vtkMatrix4x4 dircos = reader.GetDirectionCosines();
dircos.Invert();
// We need to maintain in sync information stored in vtkMedicalImageProperties:
double[] cosines = new double[6];
cosines[0] = dircos.GetElement(0,0);
cosines[1] = dircos.GetElement(1,0);
cosines[2] = dircos.GetElement(2,0);
cosines[3] = dircos.GetElement(0,1);
cosines[4] = dircos.GetElement(1,1);
cosines[5] = dircos.GetElement(2,1);
reader.GetMedicalImageProperties().SetDirectionCosine( cosines );
String outfilename = args[1];
vtkGDCMImageWriter writer = new vtkGDCMImageWriter();
writer.SetMedicalImageProperties( reader.GetMedicalImageProperties() );
writer.SetDirectionCosines( dircos );
writer.SetShift( reader.GetShift() );
writer.SetScale( reader.GetScale() );
writer.SetImageFormat( reader.GetImageFormat() );
writer.SetFileName( outfilename );
writer.SetInputConnection( reader.GetOutputPort() ); // new
//writer.SetInput( reader.GetOutput() ); // old
writer.Write();
System.out.println("Success reading: " + filename );
}
}

```

## 12.168 MIPViewer.java

```

/*=====
Program: GDCM (Grassroots DICOM). A DICOM library

Copyright (c) 2006-2011 Mathieu Malaterre
All rights reserved.
See Copyright.txt or http://gdcm.sourceforge.net/Copyright.html for details.

This software is distributed WITHOUT ANY WARRANTY; without even
the implied warranty of MERCHANTABILITY or FITNESS FOR A PARTICULAR
PURPOSE. See the above copyright notice for more information.

=====*/
import vtk.*;
import gdcm.*;
import java.io.File;
import java.awt.Canvas;

```



```

/*
 * Compilation:
 * CLASSPATH=vtkgdcm.jar:/usr/share/java/vtk.jar javac MIPViewer.java
 *
 * Usage:
 * LD_LIBRARY_PATH=/usr/lib/jvm/java-6-openjdk/jre/lib/amd64/xawt:/usr/lib/jni:.
 * CLASSPATH=/usr/share/java/vtk.jar:vtkgdcm.jar:gdcm.jar:. java MIPViewer BRAINX
 *
 */
public class MIPViewer extends Canvas
{
    static {
        // VTK
        System.loadLibrary("vtkCommonJava");
        System.loadLibrary("vtkFilteringJava");
        System.loadLibrary("vtkIOJava");
        System.loadLibrary("vtkImagingJava");
        System.loadLibrary("vtkGraphicsJava");
        System.loadLibrary("vtkRenderingJava");
        System.loadLibrary("vtkVolumeRenderingJava"); // vtkSmartVolumeMapper
        System.loadLibrary("vtkWidgetsJava"); // vtkBoxWidget
        // VTK-GDCM
        System.loadLibrary("vtkgdcmJava");
    }
    static FilenamesType fns = new FilenamesType();
    protected native int Lock();
    protected native int UnLock();
    public static void process(String path)
    {
        fns.add( path );
    }
    // Process only files under dir
    public static void visitAllFiles(File dir)
    {
        if (dir.isDirectory())
        {
            String[] children = dir.list();
            for (int i=0; i<children.length; i++)
            {
                visitAllFiles(new File(dir, children[i]));
            }
        }
        else
        {
            process(dir.getPath());
        }
    }
    public static void main(String[] args) throws Exception
    {
        String dirname = args[0];
        if( !PosixEmulation.FileIsDirectory( dirname ) )
        {
            return;
        }
        File dir = new File(dirname);
        visitAllFiles(dir);
        IPPSorter ipp = new IPPSorter();
        ipp.SetComputeZSpacing( true );
        ipp.SetZSpacingTolerance( 1e-3 );
        boolean b = ipp.Sort( fns );
        if(!b)
        {
            throw new Exception("Could not scan");
        }
        double ippzspacing = ipp.GetZSpacing();
        FilenamesType sorted = ipp.GetFilenames();
        vtkStringArray files = new vtkStringArray();
        long nfiles = sorted.size();
        //for( String f : sorted )
        for (int i = 0; i < nfiles; i++) {
            String f = sorted.get(i);
            files.InsertNextValue( f );
        }
        vtkGDCMImageReader reader = new vtkGDCMImageReader();
        reader.SetFileNames( files );
        reader.Update(); // get spacing value
        double[] spacing = reader.GetOutput().GetSpacing();
        vtkImageChangeInformation change = new vtkImageChangeInformation();
        change.SetInputConnection( reader.GetOutputPort() );
        change.SetOutputSpacing( spacing[0], spacing[1], ippzspacing );
        // Create our volume and mapper
    }
}

```

```

vtkVolume volume = new vtkVolume();
vtkSmartVolumeMapper mapper = new vtkSmartVolumeMapper();
vtkRenderWindowInteractor iren = new vtkRenderWindowInteractor();
// Add a box widget if the clip option was selected
vtkBoxWidget box = new vtkBoxWidget();
box.SetInteractor(iren);
box.SetPlaceFactor(1.01);
box.SetInputConnection(change.GetOutputPort());
//box.SetDefaultRenderer(renderer);
box.InsideOutOn();
box.PlaceWidget();
//vtkBoxWidgetCallback callback = vtkBoxWidgetCallback::New();
//callback.SetMapper(mapper);
//box.AddObserver(vtkCommand::InteractionEvent, callback);
//callback.Delete();
// Lock();
// box.EnabledOn();
// Unlock();
box.GetSelectedFaceProperty().SetOpacity(0.0);
mapper.SetInputConnection( change.GetOutputPort() );
// Create our transfer function
vtkColorTransferFunction colorFun = new vtkColorTransferFunction();
vtkPiecewiseFunction opacityFun = new vtkPiecewiseFunction();
// Create the property and attach the transfer functions
vtkVolumeProperty property = new vtkVolumeProperty();
property.IndependentComponentsOn();
property.SetColor( colorFun );
property.SetScalarOpacity( opacityFun );
property.SetInterpolationTypeToLinear();
// connect up the volume to the property and the mapper
volume.SetProperty( property );
volume.SetMapper( mapper );
vtkMedicalImageProperties medprop = reader.GetMedicalImageProperties();
int n = medprop.GetNumberOfWindowLevelPresets();
double opacityWindow = 4096;
double opacityLevel = 2048;
// Override default with value from DICOM files:
for( int i = 0; i < n; ++i )
{
    double wl[] = medprop.GetNthWindowLevelPreset(i);
    //System.out.println( "W/L: " + wl[0] + " " + wl[1] );
    opacityWindow = wl[0];
    opacityLevel = wl[1];
}
colorFun.AddRGBSegment(0.0, 1.0, 1.0, 1.0, 255.0, 1.0, 1.0, 1.0 );
opacityFun.AddSegment( opacityLevel - 0.5*opacityWindow, 0.0,
    opacityLevel + 0.5*opacityWindow, 1.0 );
mapper.SetBlendModeToMaximumIntensity();
// Create the RenderWindow, Renderer
vtkRenderer ren1 = new vtkRenderer();
vtkRenderWindow renWin = new vtkRenderWindow();
renWin.AddRenderer(ren1);
// Set the default window size
renWin.SetSize(600,600);
// Add the volume to the scene
ren1.AddVolume( volume );
ren1.ResetCamera();
iren.SetRenderWindow( renWin );
// interact with data
renWin.Render();
iren.Start();
}
}

```

## 12.169 MPRViewer.java

```

/*=====
Program: GDCM (Grassroots DICOM). A DICOM library

Copyright (c) 2006-2011 Mathieu Malaterre
All rights reserved.
See Copyright.txt or http://gdcm.sourceforge.net/Copyright.html for details.

This software is distributed WITHOUT ANY WARRANTY; without even
the implied warranty of MERCHANTABILITY or FITNESS FOR A PARTICULAR
PURPOSE. See the above copyright notice for more information.

```

```

=====*/
import vtk.*;
import gdcm.*;
import java.io.File;
/*
 * Compilation:
 * CLASSPATH=vtkgdc.jar:/usr/share/java/vtk.jar javac MPRViewer.java
 *
 * Usage:
 * LD_LIBRARY_PATH=/usr/lib/jvm/java-6-openjdk/jre/lib/amd64/xawt:/usr/lib/jni:.
 * CLASSPATH=/usr/share/java/vtk.jar:vtkgdc.jar:gdcm.jar:. java MPRViewer BRAINX
 *
 */
public class MPRViewer
{
    static {
        // VTK
        System.loadLibrary("vtkCommonJava");
        System.loadLibrary("vtkFilteringJava");
        System.loadLibrary("vtkIOJava");
        System.loadLibrary("vtkImagingJava");
        System.loadLibrary("vtkGraphicsJava");
        System.loadLibrary("vtkRenderingJava");
        // VTK-GDCM
        System.loadLibrary("vtkgdcJava");
    }
    static FilenamesType fns = new FilenamesType();
    public static void process(String path)
    {
        fns.add( path );
    }
    // Process only files under dir
    public static void visitAllFiles(File dir)
    {
        if (dir.isDirectory())
        {
            String[] children = dir.list();
            for (int i=0; i<children.length; i++)
            {
                visitAllFiles(new File(dir, children[i]));
            }
        }
        else
        {
            process(dir.getPath());
        }
    }
    public static void main(String[] args) throws Exception
    {
        String dirname = args[0];
        if( !PosixEmulation.FileIsDirectory( dirname ) )
        {
            return;
        }
        File dir = new File(dirname);
        visitAllFiles(dir);
        IPPSorter ipp = new IPPSorter();
        ipp.SetComputeZSpacing( true );
        ipp.SetZSpacingTolerance( 1e-3 );
        boolean b = ipp.Sort( fns );
        if(!b)
        {
            throw new Exception("Could not scan");
        }
        double ippzspacing = ipp.GetZSpacing();
        FilenamesType sorted = ipp.GetFilenames();
        vtkStringArray files = new vtkStringArray();
        long nfiles = sorted.size();
        //for( String f : sorted )
        for (int i = 0; i < nfiles; i++) {
            String f = sorted.get(i);
            files.InsertNextValue( f );
        }
        vtkGDCMImageReader reader = new vtkGDCMImageReader();
        reader.SetFileNames( files );
        reader.Update(); // get spacing value
        double[] spacing = reader.GetOutput().GetSpacing();
        vtkImageChangeInformation change = new vtkImageChangeInformation();
        change.SetInputConnection( reader.GetOutputPort() );
        change.SetOutputSpacing( spacing[0], spacing[1], ippzspacing );
    }
}

```

```

// A simple vtkInteractorStyleImage example for
// 3D image viewing with the vtkImageResliceMapper.
//
// Drag Left mouse button to window/level
// Shift-Left drag to rotate (oblique slice)
// Shift-Middle drag to slice through image
// OR Ctrl-Right drag to slice through image
// Create the RenderWindow, Renderer
vtkRenderer ren1 = new vtkRenderer();
vtkRenderWindow renWin = new vtkRenderWindow();
renWin.AddRenderer(ren1);
vtkImageResliceMapper im = new vtkImageResliceMapper();
im.SetInputConnection(change.GetOutputPort());
im.SliceFacesCameraOn();
im.SliceAtFocalPointOn();
im.BorderOff();
vtkImageProperty ip = new vtkImageProperty();
ip.SetColorWindow(2000);
ip.SetColorLevel(1000);
ip.SetAmbient(0.0);
ip.SetDiffuse(1.0);
ip.SetOpacity(1.0);
ip.SetInterpolationTypeToLinear();
vtkImageSlice ia = new vtkImageSlice();
ia.SetMapper(im);
ia.SetProperty(ip);
ren1.AddViewProp(ia);
ren1.SetBackground(0.1,0.2,0.4);
renWin.SetSize(300,300);
vtkRenderWindowInteractor iren = new vtkRenderWindowInteractor();
vtkInteractorStyleImage style = new vtkInteractorStyleImage();
style.SetInteractionModeToImage3D();
iren.SetInteractorStyle(style);
renWin.SetInteractor(iren);
// render the image
renWin.Render();
vtkCamera cam1 = ren1.GetActiveCamera();
cam1.ParallelProjectionOn();
ren1.ResetCameraClippingRange();
renWin.Render();
iren.Start();
}
}

```

## 12.170 MPRViewer2.java

```

/*=====
Program: GDCM (Grassroots DICOM). A DICOM library

Copyright (c) 2006-2011 Mathieu Malaterre
All rights reserved.
See Copyright.txt or http://gdcm.sourceforge.net/Copyright.html for details.

This software is distributed WITHOUT ANY WARRANTY; without even
the implied warranty of MERCHANTABILITY or FITNESS FOR A PARTICULAR
PURPOSE. See the above copyright notice for more information.

=====*/
import vtk.*;
import gdcm.*;
import java.io.File;
/*
 * Compilation:
 * CLASSPATH=vtkgdcm.jar:/usr/share/java/vtk.jar javac MPRViewer2.java
 *
 * Usage:
 * LD_LIBRARY_PATH=/usr/lib/jvm/java-6-openjdk/jre/lib/amd64/xawt:/usr/lib/jni:.
 * CLASSPATH=/usr/share/java/vtk.jar:vtkgdcm.jar:gdcm.jar:. java MPRViewer2 BRAINX
 */
public class MPRViewer2
{
    static {
        // VTK
        System.loadLibrary("vtkCommonJava");
        System.loadLibrary("vtkFilteringJava");
    }
}

```

```

System.loadLibrary("vtkIOJava");
System.loadLibrary("vtkImagingJava");
System.loadLibrary("vtkGraphicsJava");
System.loadLibrary("vtkRenderingJava");
System.loadLibrary("vtkHybridJava");
System.loadLibrary("vtkWidgetsJava");
// VTK-GDCM
System.loadLibrary("vtkgdcmJava");
}
static FilenamesType fns = new FilenamesType();
public static void process(String path)
{
    fns.add( path );
}
// Process only files under dir
public static void visitAllFiles(File dir)
{
    if (dir.isDirectory())
    {
        String[] children = dir.list();
        for (int i=0; i<children.length; i++)
        {
            visitAllFiles(new File(dir, children[i]));
        }
    }
    else
    {
        process(dir.getPath());
    }
}
public void dointer(vtkImagePlaneWidget current_widget)
{
    int cstat = current_widget.GetCursorDataStatus();
    double[] v = current_widget.GetCurrentCursorPosition();
    //System.out.println( cstat );
    //System.out.println( v[0] );
    //System.out.println( v[1] );
    //System.out.println( v[2] );
    planeWidgetX.SetSliceIndex( (int)v[0] );
    planeWidgetY.SetSliceIndex( (int)v[1] );
    planeWidgetZ.SetSliceIndex( (int)v[2] );
    planeWidgetX.GetCurrentRenderer().ResetCameraClippingRange();
    planeWidgetY.GetCurrentRenderer().ResetCameraClippingRange();
    planeWidgetZ.GetCurrentRenderer().ResetCameraClippingRange();
}
public void startinterX()
{
    dointer( planeWidgetX );
}
public void interX()
{
    dointer( planeWidgetX );
}
public void endinterX()
{
}
public void startinterY()
{
    dointer( planeWidgetY );
}
public void interY()
{
    dointer( planeWidgetY );
}
public void endinterY()
{
}
public void startinterZ()
{
    dointer( planeWidgetZ );
}
public void interZ()
{
    dointer( planeWidgetZ );
}
public void endinterZ()
{
    //System.out.println( "endinter" );
}
public static void AlignCamera(int slice_number, vtkImagePlaneWidget current_widget)
{

```

```

vtkImageData image = (vtkImageData)current_widget.GetInput();
vtkRenderer ren = current_widget.GetCurrentRenderer();
double[] origin = image.GetOrigin();
double ox = origin[0];
double oy = origin[1];
double oz = origin[2];
int dims[] = image.GetDimensions();
int xmin = 0;
int xmax = 1;
int ymin = 2;
int ymax = dims[0]-1;
int zmin = dims[1]-1;
int zmax = dims[2]-1;
double[] spacing = image.GetSpacing();
double sx = spacing[0];
double sy = spacing[1];
double sz = spacing[2];
double cx = ox+(0.5*(xmax-xmin))*sx;
double cy = oy+(0.5*(ymax-ymin))*sy;
double cz = oz+(0.5*(zmax-zmin))*sz;
double vx = 0, vy = 0, vz = 0;
double nx = 0, ny = 0, nz = 0;
int iaxis = current_widget.GetPlaneOrientation();
if ( iaxis == 0 ) {
    vz = -1;
    nx = ox + xmax*sx;
    cx = ox + slice_number*sx;
}
else if ( iaxis == 1 ) {
    vz = -1;
    ny = oy+ymax*sy;
    cy = oy+slice_number*sy;
}
else {
    vy = 1;
    nz = oz+zmax*sz;
    cz = oz+slice_number*sz;
}
double px = cx+nx*2;
double py = cy+ny*2;
double pz = cz+nz*3;
vtkCamera camera = ren.GetActiveCamera();
camera.SetViewUp(vx, vy, vz);
camera.SetFocalPoint(cx, cy, cz);
camera.SetPosition(px, py, pz);
camera.OrthogonalizeViewUp();
ren.ResetCameraClippingRange();
}
private vtkImagePlaneWidget planeWidgetX = new vtkImagePlaneWidget();
private vtkImagePlaneWidget planeWidgetY = new vtkImagePlaneWidget();
private vtkImagePlaneWidget planeWidgetZ = new vtkImagePlaneWidget();
public void config()
{
    //System.out.println( "config" );
    planeWidgetX.GetCurrentRenderer().ResetCamera();
    planeWidgetY.GetCurrentRenderer().ResetCamera();
    planeWidgetZ.GetCurrentRenderer().ResetCamera();
}
public void Run(String dirname)
{
    File dir = new File(dirname);
    visitAllFiles(dir);
    IPPSorter ipp = new IPPSorter();
    ipp.SetComputeZSpacing( true );
    ipp.SetZSpacingTolerance( 1e-3 );
    boolean b = ipp.Sort( fns );
    if(!b)
    {
        //throw new Exception("Could not scan");
    }
    double ippzspacing = ipp.GetZSpacing();
    FilenamesType sorted = ipp.GetFilenames();
    vtkStringArray files = new vtkStringArray();
    long nfiles = sorted.size();
    //for( String f : sorted )
    for (int i = 0; i < nfiles; i++) {
        String f = sorted.get(i);
        files.InsertNextValue( f );
    }
    vtkGDCMImageReader reader = new vtkGDCMImageReader();
    reader.SetFileNames( files );
}

```

```

reader.Update(); // get spacing value
double[] spacing = reader.GetOutput().GetSpacing();
vtkImageChangeInformation change = new vtkImageChangeInformation();
change.SetInputConnection( reader.GetOutputPort() );
change.SetOutputSpacing( spacing[0], spacing[1], ippzspacing );
change.Update();
System.out.println( change.GetOutput().toString() );
vtkRenderer ren1 = new vtkRenderer();
ren1.SetViewport(0., 0., 0.333, 1);
ren1.SetBackground(0.1,0.2,0.4);
vtkRenderer ren2 = new vtkRenderer();
ren2.SetViewport(0.333, 0., 0.667, 1);
ren2.SetBackground(0.1,0.2,0.4);
vtkRenderer ren3 = new vtkRenderer();
ren3.SetViewport(0.667, 0., 1., 1.);
ren3.SetBackground(0.1,0.2,0.4);
vtkRenderWindow renWin = new vtkRenderWindow();
renWin.AddRenderer(ren1);
renWin.AddRenderer(ren2);
renWin.AddRenderer(ren3);
vtkRenderWindowInteractor iren = new vtkRenderWindowInteractor();
iren.SetRenderWindow(renWin);
vtkInteractorStyleImage style = new vtkInteractorStyleImage();
iren.SetInteractorStyle( style );
vtkCellPicker picker = new vtkCellPicker();
picker.SetTolerance(0.005);
vtkProperty ipwProp = new vtkProperty();
//vtkImagePlaneWidget planeWidgetX = new vtkImagePlaneWidget();
planeWidgetX.SetInteractor(iren);
planeWidgetX.SetCurrentRenderer(ren1);
planeWidgetX.SetDefaultRenderer(ren1);
planeWidgetX.RestrictPlaneToVolumeOn();
planeWidgetX.SetTexturePlaneProperty(ipwProp);
//planeWidgetX.GetPlaneProperty().SetColor(1,0,0);
//planeWidgetX.TextureInterpolateOff();
//planeWidgetX.SetResliceInterpolateToNearestNeighbour();
planeWidgetX.SetInputConnection(change.GetOutputPort());
planeWidgetX.SetPlaneOrientationToXAxes();
planeWidgetX.SetSliceIndex(62);
planeWidgetX.SetPicker(picker);
planeWidgetX.SetKeyPressActivationValue('x');
planeWidgetX.On();
planeWidgetX.InteractionOn();
//vtkImagePlaneWidget planeWidgetY = new vtkImagePlaneWidget();
planeWidgetY.SetInteractor(iren);
planeWidgetY.SetCurrentRenderer(ren2);
planeWidgetY.SetDefaultRenderer(ren2);
planeWidgetY.RestrictPlaneToVolumeOn();
planeWidgetY.SetTexturePlaneProperty(ipwProp);
//planeWidgetY.GetPlaneProperty().SetColor(1,0,0);
//planeWidgetY.TextureInterpolateOff();
//planeWidgetY.SetResliceInterpolateToNearestNeighbour();
planeWidgetY.SetInputConnection(change.GetOutputPort());
planeWidgetY.SetLookupTable(planeWidgetX.GetLookupTable());
planeWidgetY.SetPlaneOrientationToYAxes();
planeWidgetY.SetSliceIndex(32);
planeWidgetY.SetPicker(picker);
planeWidgetY.SetKeyPressActivationValue('y');
planeWidgetY.On();
//vtkImagePlaneWidget planeWidgetZ = new vtkImagePlaneWidget();
planeWidgetZ.SetInteractor(iren);
planeWidgetZ.SetCurrentRenderer(ren3);
planeWidgetZ.SetDefaultRenderer(ren3);
planeWidgetZ.RestrictPlaneToVolumeOn();
planeWidgetZ.SetTexturePlaneProperty(ipwProp);
//planeWidgetZ.GetPlaneProperty().SetColor(1,0,0);
//planeWidgetZ.TextureInterpolateOff();
//planeWidgetZ.SetResliceInterpolateToNearestNeighbour();
planeWidgetZ.SetInputConnection(change.GetOutputPort());
planeWidgetZ.SetLookupTable(planeWidgetX.GetLookupTable());
planeWidgetZ.SetPlaneOrientationToZAxes();
planeWidgetZ.SetSliceIndex(32);
planeWidgetZ.SetPicker(picker);
planeWidgetZ.SetKeyPressActivationValue('z');
planeWidgetZ.On();
iren.Initialize();
renWin.Render();
AlignCamera(52, planeWidgetX);
AlignCamera(32, planeWidgetY);
AlignCamera(32, planeWidgetZ);
planeWidgetX.GetCurrentRenderer().ResetCamera();

```

```

planeWidgetY.GetCurrentRenderer().ResetCamera();
planeWidgetZ.GetCurrentRenderer().ResetCamera();
renWin.Render();
planeWidgetX.AddObserver("StartInteractionEvent", this,"startinterX");
planeWidgetX.AddObserver("InteractionEvent", this,"interX");
planeWidgetX.AddObserver("EndInteractionEvent", this,"endinterX");
planeWidgetY.AddObserver("StartInteractionEvent", this,"startinterY");
planeWidgetY.AddObserver("InteractionEvent", this,"interY");
planeWidgetY.AddObserver("EndInteractionEvent", this,"endinterY");
planeWidgetZ.AddObserver("StartInteractionEvent", this,"startinterZ");
planeWidgetZ.AddObserver("InteractionEvent", this,"interZ");
planeWidgetZ.AddObserver("EndInteractionEvent", this,"endinterZ");
iren.AddObserver("ConfigureEvent", this,"config");
iren.Start();
}
}

public static void main(String[] args) throws Exception
{
String dirname = args[0];
if( !PosixEmulation.FileIsDirectory( dirname ) )
{
return;
}
MPRViewer2 me = new MPRViewer2();
me.Run( dirname );
}
}

```

## 12.171 ReadSeriesIntoVTK.java

```

/*=====
Program: GDCM (Grassroots DICOM). A DICOM library

Copyright (c) 2006-2011 Mathieu Malaterre
All rights reserved.
See Copyright.txt or http://gdcm.sourceforge.net/Copyright.html for details.

This software is distributed WITHOUT ANY WARRANTY; without even
the implied warranty of MERCHANTABILITY or FITNESS FOR A PARTICULAR
PURPOSE. See the above copyright notice for more information.

=====*/
// We are required to call the package 'vtk' eventhough I (MM) would have preferred
// an import statement along the line of:
// import vtkgdcm.*;
import vtk.*;
/*
 * Usage:
 * export LD_LIBRARY_PATH=/usr/lib/jvm/java-6-openjdk/jre/lib/amd64/xawt:.
 * java -classpath 'pwd'/vtkgdcm.jar:/usr/share/java/vtk.jar:. ReadSeriesIntoVTK
 */
public class ReadSeriesIntoVTK
{
static {
System.loadLibrary("vtkCommonJava");
System.loadLibrary("vtkFilteringJava");
System.loadLibrary("vtkIOJava");
System.loadLibrary("vtkImagingJava");
System.loadLibrary("vtkGraphicsJava");
System.loadLibrary("vtkgdcmJava");
try {
System.loadLibrary("vtkRenderingJava");
} catch (Throwable e) {
System.out.println("cannot load vtkHybrid, skipping...");
}
try {
System.loadLibrary("vtkHybridJava");
} catch (Throwable e) {
System.out.println("cannot load vtkHybrid, skipping...");
}
try {
System.loadLibrary("vtkVolumeRenderingJava");
} catch (Throwable e) {
System.out.println("cannot load vtkVolumeRendering, skipping...");
}
}
}
public static void main(String[] args)

```



```

{
    vtkFileOutputWindow outWin = new vtkFileOutputWindow();
    outWin.SetInstance(outWin);
    outWin.SetFileName("MVSViewer.log");
    // See: http://review.source.kitware.com/#change,888
    // vtkWrapJava does not handle static keyword
    // String directory = vtkGDCMTesting.GetGDCMDataRoot();
    vtkGDCMTesting t = new vtkGDCMTesting();
    String directory = t.GetGDCMDataRoot();
    String file0 = directory + "/SIEMENS_MAGNETOM-12-MONO2-FileSeq0.dcm";
    String file1 = directory + "/SIEMENS_MAGNETOM-12-MONO2-FileSeq1.dcm";
    String file2 = directory + "/SIEMENS_MAGNETOM-12-MONO2-FileSeq2.dcm";
    String file3 = directory + "/SIEMENS_MAGNETOM-12-MONO2-FileSeq3.dcm";
    vtkStringArray s = new vtkStringArray();
    System.out.println("adding : " + file0);
    s.InsertNextValue( file0 );
    s.InsertNextValue( file1 );
    s.InsertNextValue( file2 );
    s.InsertNextValue( file3 );
    vtkGDCMImageReader reader = new vtkGDCMImageReader();
    reader.SetFileNames( s );
    reader.Update();
    System.out.println("Success reading: " + file0 );
    vtkMetaImageWriter writer = new vtkMetaImageWriter();
    writer.DebugOn();
    writer.SetCompression( false );
    writer.SetInputConnection( reader.GetOutputPort() );
    writer.SetFileName( "ReadSeriesIntoVTK.mhd" );
    writer.Write();
    System.out.println("Success writing: " + writer.GetFileName() );
}
}

```

## 12.172 CastConvertPhilips.py

```

1
14
15 """
16 Usage:
17
18 python --public /path/to/directory/
19 or
20 python --private /path/to/directory/
21
22 python --public --extension bak /path/to/directory/
23
24 rename -f 's/\.bak$/' *.bak
25
26 TODO:
27 http://docs.python.org/library/optparse.html#module-optparse
28 """
29
30 import vtkgdc
31 import vtk
32 import sys
33 import gdc
34
35 def ProcessOneFilePublic(filename, outfilename, tmpfile):
36     gdc.ImageHelper.SetForceRescaleInterceptSlope(True)
37     vtkreader = vtkgdc.vtkGDCMImageReader()
38     vtkreader.SetFileName( filename )
39     vtkreader.Update()
40
41     cast = vtk.vtkImageCast()
42     cast.SetInput( vtkreader.GetOutput() )
43     cast.SetOutputScalarTypeToUnsignedShort()
44
45     # vtkGDCMImageWriter does not support Sequence, so let's write a tmp file first:
46     # Some operation will actually be discarded (we simply need a temp storage)
47     vtkwriter = vtkgdc.vtkGDCMImageWriter()
48     vtkwriter.SetFileName( tmpfile )
49     vtkwriter.SetMedicalImageProperties( vtkreader.GetMedicalImageProperties() )
50     vtkwriter.SetDirectionCosines( vtkreader.GetDirectionCosines() )
51     print "Format:", vtkreader.GetImageFormat()
52     vtkwriter.SetImageFormat( vtkreader.GetImageFormat() )
53     vtkwriter.SetInput( cast.GetOutput() )
54     #vtkwriter.Update()

```

```

55  vtkwriter.Write()
56
57  # ok now rewrite the exact same file as the original (keep all info)
58  # but use the Pixel Data Element from the written file
59  tmpreader = gdcM.ImageReader()
60  tmpreader.SetFileName( tmpfile )
61  if not tmpreader.Read():
62      sys.exit(1)
63
64  reader = gdcM.Reader()
65  reader.SetFileName( filename )
66  if not reader.Read():
67      sys.exit(1)
68
69  # Make sure to remove Slope/Rescale to avoid re-execution
70  ds = reader.GetFile().GetDataSet()
71  tags = [
72      gdcM.Tag(0x0028,0x1052),
73      gdcM.Tag(0x0028,0x1053),
74      gdcM.Tag(0x0028,0x1053),
75  ]
76  for tag in tags:
77      ds.Remove( tag )
78
79  writer = gdcM.ImageWriter()
80  writer.SetFileName( outfilename )
81  # Pass image from vtk written file
82  writer.SetImage( tmpreader.GetImage() )
83  # pass dataset from initial 'reader'
84  writer.SetFile( reader.GetFile() )
85  if not writer.Write():
86      sys.exit(1)
87
88  def ProcessOneFilePrivate(filename, outfilename, tmpfile):
89      vtkreader = vtkgdcM.vtkGDCMImageReader()
90      vtkreader.SetFileName( filename )
91      vtkreader.Update()
92
93
94      # (2005,1409)    DS      4      0.0
95      # (2005,140a)   DS      16     1.52283272283272
96
97      # (2005,0014)   LO      26     Philips MR Imaging DD 005
98      tag1 = gdcM.PrivateTag(0x2005,0x09,"Philips MR Imaging DD 005")
99      tag2 = gdcM.PrivateTag(0x2005,0x0a,"Philips MR Imaging DD 005")
100
101
102
103      # Need to access some private tags, reread the file (for now):
104      reader = gdcM.Reader()
105      reader.SetFileName( filename )
106      if not reader.Read():
107          sys.exit(1)
108
109      ds = reader.GetFile().GetDataSet()
110
111      e11 = ds.GetDataElement( tag1 )
112      e12 = ds.GetDataElement( tag2 )
113
114
115      #pf = gdcM.PythonFilter()
116      #pf.SetFile( reader.GetFile() )
117      #print e11.GetTag()
118
119      print e11.GetByteValue()
120      v1 = eval(e11.GetByteValue().GetBuffer())
121      print e12.GetByteValue()
122      v2 = eval(e12.GetByteValue().GetBuffer())
123
124      print v1
125      shift = v1
126      print v2
127      scale = v2
128
129      ss = vtk.vtkImageShiftScale()
130      ss.SetInput( vtkreader.GetOutput() )
131      # because VTK image shift / scale convention is inverted from DICOM make sure shift is 0
132      assert shift == 0
133      ss.SetShift( shift )
134      ss.SetScale( scale )
135      ss.SetOutputScalarTypeToUnsignedShort ( )

```

```

136 ss.Update()
137
138 # vtkGDCMImageWriter does not support Sequence, so let's write a tmp file first:
139 # Some operation will actually be discarded (we simply need a temp storage)
140 vtkwriter = vtkgdcml.vtkGDCMImageWriter()
141 vtkwriter.SetFileName( tmpfile )
142 vtkwriter.SetMedicalImageProperties( vtkreader.GetMedicalImageProperties() )
143 vtkwriter.SetDirectionCosines( vtkreader.GetDirectionCosines() )
144 vtkwriter.SetImageFormat( reader.GetImageFormat() )
145 # do not pass shift/scale again
146 vtkwriter.SetInput( ss.GetOutput() )
147 #vtkwriter.Update()
148 vtkwriter.Write()
149
150 # ok now rewrite the exact same file as the original (keep all info)
151 # but use the Pixel Data Element from the written file
152 tmpreader = gdcml.ImageReader()
153 tmpreader.SetFileName( tmpfile )
154 if not tmpreader.Read():
155     sys.exit(1)
156
157 writer = gdcml.ImageWriter()
158 writer.SetFileName( outfile )
159 # Pass image from vtk written file
160 writer.SetImage( tmpreader.GetImage() )
161 # pass dataset from initial 'reader'
162 writer.SetFile( reader.GetFile() )
163 if not writer.Write():
164     sys.exit(1)
165
166 if __name__ == "__main__":
167
168     gdcml.Trace.DebugOff()
169     gdcml.Trace.WarningOff()
170     #filename = sys.argv[1]
171     #outfile = sys.argv[2]
172     tmpfile = "/tmp/philips_rescaled.dcm"
173     #ProcessOneFile( filename, outfile, tmpfile )
174     rescaletype = sys.argv[1]
175     assert rescaletype == "--public" or rescaletype == "--private"
176     dirname = sys.argv[2]
177     d = gdcml.Directory()
178     d.Load( dirname )
179
180     for f in d.GetFileNames():
181         #print f
182         ProcessOneFilePublic( f, f + ".bak", tmpfile )
183
184
185 print "success"

```

## 12.173 headsq2dcm.py

```

1
14
15 """
16 Usage:
17 python headsq2dcm.py -D /path/to/VTKData
18 """
19
20 import vtk
21 import vtkgdcml
22 from vtk.util.misc import vtkGetDataRoot
23 VTK_DATA_ROOT = vtkGetDataRoot()
24
25 reader = vtk.vtkVolume16Reader()
26 reader.SetDataDimensions(64, 64)
27 reader.SetDataByteOrderToLittleEndian()
28 reader.SetFilePrefix(VTK_DATA_ROOT + "/Data/headsq/quarter")
29 reader.SetImageRange(1, 93)
30 reader.SetDataSpacing(3.2, 3.2, 1.5)
31
32 cast = vtk.vtkImageCast()
33 cast.SetInput( reader.GetOutput() )
34 cast.SetOutputScalarTypeToUnsignedChar()
35
36 # By default this is creating a Multiframe Grayscale Word Secondary Capture Image Storage

```

```
37 writer = vtkgdc.vtkGDCImageWriter()
38 writer.SetFileName( "headsq.dcm" )
39 writer.SetInput( reader.GetOutput() )
40 # cast -> Multiframe Grayscale Byte Secondary Capture Image Storage
41 #writer.SetInput( cast.GetOutput() )
42 writer.SetFileDimensionality( 3 )
43 writer.Write()
```

# Index

- ~ASN1
  - gdcM::ASN1, [131](#)
- ~AnonymizeEvent
  - gdcM::AnonymizeEvent, [109](#)
- ~Anonymizer
  - gdcM::Anonymizer, [113](#)
- ~Attribute
  - gdcM::Attribute< Group, Element, TVR, VM::VM1\_n >, [155](#)
- ~AudioCodec
  - gdcM::AudioCodec, [167](#)
- ~BaseCompositeMessage
  - gdcM::network::BaseCompositeMessage, [172](#)
- ~BaseNormalizedMessage
  - gdcM::network::BaseNormalizedMessage, [174](#)
- ~BasePDU
  - gdcM::network::BasePDU, [176](#)
- ~BaseQuery
  - gdcM::BaseQuery, [179](#)
- ~BaseRootQuery
  - gdcM::BaseRootQuery, [185](#)
- ~Bitmap
  - gdcM::Bitmap, [197](#)
- ~BitmapToBitmapFilter
  - gdcM::BitmapToBitmapFilter, [211](#)
- ~BoxRegion
  - gdcM::BoxRegion, [214](#)
- ~ByteSwapFilter
  - gdcM::ByteSwapFilter, [222](#)
- ~ByteValue
  - gdcM::ByteValue, [225](#)
- ~CAPICryptographicMessageSyntax
  - gdcM::CAPICryptographicMessageSyntax, [234](#)
- ~CSAHeader
  - gdcM::CSAHeader, [289](#)
- ~Coder
  - gdcM::Coder, [250](#)
- ~Command
  - gdcM::Command, [259](#)
- ~CommandDataSet
  - gdcM::CommandDataSet, [261](#)
- ~CryptoFactory
  - gdcM::CryptoFactory, [274](#)
- ~CryptographicMessageSyntax
  - gdcM::CryptographicMessageSyntax, [276](#)
- ~Curve
  - gdcM::Curve, [305](#)
- ~DICOMDIRGenerator
  - gdcM::DICOMDIRGenerator, [356](#)
- ~DataEvent
  - gdcM::DataEvent, [325](#)
- ~DataSetEvent
  - gdcM::DataSetEvent, [342](#)
- ~Decoder
  - gdcM::Decoder, [345](#)
- ~Defs
  - gdcM::Defs, [349](#)
- ~DeltaEncodingCodec
  - gdcM::DeltaEncodingCodec, [353](#)
- ~DictConverter
  - gdcM::DictConverter, [365](#)
- ~DictPrinter
  - gdcM::DictPrinter, [375](#)
- ~Dicts
  - gdcM::Dicts, [377](#)
- ~DirectionCosines
  - gdcM::DirectionCosines, [383](#)
- ~Directory
  - gdcM::Directory, [387](#)
- ~Dumper
  - gdcM::Dumper, [395](#)
- ~Element
  - gdcM::Element< TVR, VM::VM1\_n >, [404](#)
- ~EmptyMaskGenerator
  - gdcM::EmptyMaskGenerator, [425](#)
- ~Event
  - gdcM::Event, [436](#)
- ~Exception
  - gdcM::Exception, [439](#)
- ~File
  - gdcM::File, [449](#)
- ~FileAnonymizer
  - gdcM::FileAnonymizer, [454](#)
- ~FileChangeTransferSyntax
  - gdcM::FileChangeTransferSyntax, [458](#)
- ~FileDecompressLookupTable
  - gdcM::FileDecompressLookupTable, [461](#)
- ~FileDerivation
  - gdcM::FileDerivation, [464](#)
- ~FileExplicitFilter

- gdcM::FileExplicitFilter, [468](#)
- ~FileMetalInformation
  - gdcM::FileMetalInformation, [473](#)
- ~FileNameEvent
  - gdcM::FileNameEvent, [485](#)
- ~FileStreamer
  - gdcM::FileStreamer, [495](#)
- ~FilenameGenerator
  - gdcM::FilenameGenerator, [489](#)
- ~Global
  - gdcM::Global, [512](#)
- ~GroupDict
  - gdcM::GroupDict, [516](#)
- ~IconImageFilter
  - gdcM::IconImageFilter, [518](#)
- ~IconImageGenerator
  - gdcM::IconImageGenerator, [522](#)
- ~Image
  - gdcM::Image, [527](#)
- ~ImageApplyLookupTable
  - gdcM::ImageApplyLookupTable, [534](#)
- ~ImageChangePhotometricInterpretation
  - gdcM::ImageChangePhotometricInterpretation, [537](#)
- ~ImageChangePlanarConfiguration
  - gdcM::ImageChangePlanarConfiguration, [541](#)
- ~ImageChangeTransferSyntax
  - gdcM::ImageChangeTransferSyntax, [545](#)
- ~ImageCodec
  - gdcM::ImageCodec, [551](#)
- ~ImageConverter
  - gdcM::ImageConverter, [562](#)
- ~ImageFragmentSplitter
  - gdcM::ImageFragmentSplitter, [566](#)
- ~ImageReader
  - gdcM::ImageReader, [576](#)
- ~ImageRegionReader
  - gdcM::ImageRegionReader, [580](#)
- ~ImageToImageFilter
  - gdcM::ImageToImageFilter, [584](#)
- ~ImageWriter
  - gdcM::ImageWriter, [587](#)
- ~JPEG12Codec
  - gdcM::JPEG12Codec, [617](#)
- ~JPEG16Codec
  - gdcM::JPEG16Codec, [620](#)
- ~JPEG2000Codec
  - gdcM::JPEG2000Codec, [624](#)
- ~JPEG8Codec
  - gdcM::JPEG8Codec, [631](#)
- ~JPEGCodec
  - gdcM::JPEGCodec, [635](#)
- ~JPEGLSCodec
  - gdcM::JPEGLSCodec, [644](#)
- ~JSON
  - gdcM::JSON, [649](#)
- ~KAKADUCodec
  - gdcM::KAKADUCodec, [652](#)
- ~LookupTable
  - gdcM::LookupTable, [660](#)
- ~MemberCommand
  - gdcM::MemberCommand< T >, [689](#)
- ~MeshPrimitive
  - gdcM::MeshPrimitive, [695](#)
- ~ModuleEntry
  - gdcM::ModuleEntry, [710](#)
- ~MrProtocol
  - gdcM::MrProtocol, [721](#)
- ~Object
  - gdcM::Object, [751](#)
- ~OpenSSLCryptographicMessageSyntax
  - gdcM::OpenSSLCryptographicMessageSyntax, [756](#)
- ~OpenSSLP7CryptographicMessageSyntax
  - gdcM::OpenSSLP7CryptographicMessageSyntax, [761](#)
- ~Orientation
  - gdcM::Orientation, [764](#)
- ~Overlay
  - gdcM::Overlay, [770](#)
- ~PDBHeader
  - gdcM::PDBHeader, [792](#)
- ~PDFCodec
  - gdcM::PDFCodec, [796](#)
- ~PGXCodec
  - gdcM::PGXCodec, [804](#)
- ~PNMCodec
  - gdcM::PNMCodec, [838](#)
- ~PVRGCodec
  - gdcM::PVRGCodec, [879](#)
- ~ParseException
  - gdcM::ParseException, [778](#)
- ~Parser
  - gdcM::Parser, [782](#)
- ~Pixmap
  - gdcM::Pixmap, [821](#)
- ~PixmapReader
  - gdcM::PixmapReader, [827](#)
- ~PixmapToPixmapFilter
  - gdcM::PixmapToPixmapFilter, [831](#)
- ~PixmapWriter
  - gdcM::PixmapWriter, [834](#)
- ~Preamble
  - gdcM::Preamble, [842](#)
- ~Printer
  - gdcM::Printer, [865](#)
- ~PrivateDict
  - gdcM::PrivateDict, [869](#)
- ~ProgressEvent
  - gdcM::ProgressEvent, [876](#)

- ~PythonFilter
  - gdcM::PythonFilter, [882](#)
- ~QueryBase
  - gdcM::QueryBase, [884](#)
- ~RAWCodec
  - gdcM::RAWCodec, [899](#)
- ~RLECodec
  - gdcM::RLECodec, [921](#)
- ~Reader
  - gdcM::Reader, [905](#)
- ~Region
  - gdcM::Region, [912](#)
- ~Rescaler
  - gdcM::Rescaler, [916](#)
- ~SHA1
  - gdcM::SHA1, [991](#)
- ~Scanner
  - gdcM::Scanner, [930](#)
- ~Segment
  - gdcM::Segment, [939](#)
- ~SegmentReader
  - gdcM::SegmentReader, [951](#)
- ~SegmentWriter
  - gdcM::SegmentWriter, [954](#)
- ~SegmentedPaletteColorLookupTable
  - gdcM::SegmentedPaletteColorLookupTable, [947](#)
- ~SerieHelper
  - gdcM::SerieHelper, [975](#)
- ~ServiceClassUser
  - gdcM::ServiceClassUser, [984](#)
- ~SimpleMemberCommand
  - gdcM::SimpleMemberCommand< T >, [995](#)
- ~SimpleSubjectWatcher
  - gdcM::SimpleSubjectWatcher, [998](#)
- ~SmartPointer
  - gdcM::SmartPointer< ObjectType >, [1005](#)
- ~Sorter
  - gdcM::Sorter, [1013](#)
- ~Spacing
  - gdcM::Spacing, [1018](#)
- ~SplitMosaicFilter
  - gdcM::SplitMosaicFilter, [1020](#)
- ~StreamImageReader
  - gdcM::StreamImageReader, [1026](#)
- ~StreamImageWriter
  - gdcM::StreamImageWriter, [1031](#)
- ~StrictScanner
  - gdcM::StrictScanner, [1039](#)
- ~StringFilter
  - gdcM::StringFilter, [1051](#)
- ~Subject
  - gdcM::Subject, [1057](#)
- ~Surface
  - gdcM::Surface, [1062](#)
- ~SurfaceReader
  - gdcM::SurfaceReader, [1079](#)
- ~SurfaceWriter
  - gdcM::SurfaceWriter, [1082](#)
- ~Table
  - gdcM::Table, [1097](#)
- ~TableEntry
  - gdcM::TableEntry, [1099](#)
- ~TableReader
  - gdcM::TableReader, [1101](#)
- ~TableRow
  - gdcM::network::TableRow, [1105](#)
- ~TagPath
  - gdcM::TagPath, [1117](#)
- ~Testing
  - gdcM::Testing, [1120](#)
- ~Trace
  - gdcM::Trace, [1128](#)
- ~Transition
  - gdcM::network::Transition, [1142](#)
- ~ULAction
  - gdcM::network::ULAction, [1188](#)
- ~ULBasicCallback
  - gdcM::network::ULBasicCallback, [1228](#)
- ~ULConnection
  - gdcM::network::ULConnection, [1231](#)
- ~ULConnectionCallback
  - gdcM::network::ULConnectionCallback, [1236](#)
- ~ULConnectionManager
  - gdcM::network::ULConnectionManager, [1242](#)
- ~ULEvent
  - gdcM::network::ULEvent, [1249](#)
- ~ULWritingCallback
  - gdcM::network::ULWritingCallback, [1253](#)
- ~UserInformation
  - gdcM::network::UserInformation, [1264](#)
- ~Validate
  - gdcM::Validate, [1268](#)
- ~Value
  - gdcM::Value, [1271](#)
- ~Version
  - gdcM::Version, [1275](#)
- ~Writer
  - gdcM::Writer, [1421](#)
- ~XMLDictReader
  - gdcM::XMLDictReader, [1425](#)
- ~XMLPrinter
  - gdcM::XMLPrinter, [1429](#)
- ~XMLPrivateDictReader
  - gdcM::XMLPrivateDictReader, [1432](#)
- ~vtkGDCMImageReader
  - vtkGDCMImageReader, [1301](#)
- ~vtkGDCMImageReader2
  - vtkGDCMImageReader2, [1316](#)

- ~vtkGDCMImageWriter
  - vtkGDCMImageWriter, [1330](#)
- ~vtkGDCMMedicalImageProperties
  - vtkGDCMMedicalImageProperties, [1338](#)
- ~vtkGDCMPolyDataReader
  - vtkGDCMPolyDataReader, [1342](#)
- ~vtkGDCMPolyDataWriter
  - vtkGDCMPolyDataWriter, [1347](#)
- ~vtkGDCMTesting
  - vtkGDCMTesting, [1352](#)
- ~vtkGDCMThreadedImageReader
  - vtkGDCMThreadedImageReader, [1356](#)
- ~vtkGDCMThreadedImageReader2
  - vtkGDCMThreadedImageReader2, [1360](#)
- ~vtkImageColorViewer
  - vtkImageColorViewer, [1370](#)
- ~vtkImageMapToColors16
  - vtkImageMapToColors16, [1383](#)
- ~vtkImageMapToWindowLevelColors2
  - vtkImageMapToWindowLevelColors2, [1389](#)
- ~vtkImagePlanarComponentsToComponents
  - vtkImagePlanarComponentsToComponents, [1393](#)
- ~vtkImageRGBToYBR
  - vtkImageRGBToYBR, [1395](#)
- ~vtkImageYBRToRGB
  - vtkImageYBRToRGB, [1398](#)
- ~vtkLookupTable16
  - vtkLookupTable16, [1401](#)
- ~vtkRTStructSetProperties
  - vtkRTStructSetProperties, [1405](#)
- AAbortPDU
  - gdcm::network::AAbortPDU, [88](#)
- AAssociateACPDU
  - gdcm::network::AAssociateACPDU, [91](#)
  - gdcm::network::AAssociateRQPDU, [103](#)
- AAssociateRJPDU
  - gdcm::network::AAssociateRJPDU, [95](#)
- AAssociateRQPDU
  - gdcm::network::AAssociateACPDU, [94](#)
  - gdcm::network::AAssociateRQPDU, [99](#)
- AbstractMultiDimensionalImageModel
  - gdcm::UIDs, [1175](#)
- AbstractSyntax
  - gdcm::network::AbstractSyntax, [105](#)
  - gdcm::PresentationContext, [848](#)
- AcquisitionContextSRStorage
  - gdcm::UIDs, [1174](#)
- ActiveComponent
  - vtkImageMapToColors16, [1387](#)
- Add
  - gdcm::GroupDict, [516](#)
- add1
  - gdcm, [63](#)
- AddAcceptedPresentationContext
  - gdcm::network::ULConnection, [1231](#)
- AddContourReferencedFrameOfReference
  - vtkRTStructSetProperties, [1405](#)
- AddCSAHeaderDictEntry
  - gdcm::CSAHeaderDict, [294](#)
- AddDerivationDescription
  - gdcm::FileDerivation, [464](#)
- AddDictEntry
  - gdcm::Dict, [361](#)
  - gdcm::PrivateDict, [869](#)
- AddFile
  - gdcm::FileSet, [492](#)
  - gdcm::SerieHelper, [975](#)
- AddFileName
  - gdcm::SerieHelper, [976](#)
- AddFragment
  - gdcm::SequenceOfFragments, [959](#)
- AddFromFile
  - gdcm::PresentationContextGenerator, [853](#)
- AddGroupLength
  - gdcm::DictConverter, [365](#)
- AddImageDirectoryRecord
  - gdcm::DICOMDIRGenerator, [357](#)
- AddInput
  - vtkImageColorViewer, [1370](#)
- AddInputConnection
  - vtkImageColorViewer, [1370](#)
- AddIOD
  - gdcm::IODs, [604](#)
- AddIODEntry
  - gdcm::IOD, [598](#)
- AddItem
  - gdcm::SequenceOfItems, [968](#)
- AddMacro
  - gdcm::Macros, [671](#)
  - gdcm::Module, [706](#)
- AddMacroEntry
  - gdcm::Macro, [668](#)
- AddModule
  - gdcm::Modules, [714](#)
- AddModuleEntry
  - gdcm::Module, [706](#)
  - gdcm::NestedModuleEntries, [734](#)
- AddNewUndefinedLengthItem
  - gdcm::SequenceOfItems, [968](#)
- AddObserver
  - gdcm::Subject, [1057](#)
- AddPatientDirectoryRecord
  - gdcm::DICOMDIRGenerator, [357](#)
- AddPresentationContext
  - gdcm::network::AAssociateRQPDU, [99](#)
  - gdcm::PresentationContextGenerator, [853](#)
- AddPresentationContextAC



- gdcM::network::AAssociateACPDU, 92
- AddPresentationDataValue
  - gdcM::network::PDataTFPDU, 786
- AddPrimitiveData
  - gdcM::MeshPrimitive, 695
- AddPrivateTag
  - gdcM::Scanner, 930
  - gdcM::StrictScanner, 1039
- AddPurposeOfReferenceCodeSequence
  - gdcM::FileDerivation, 464
- AddQueryDataSet
  - gdcM::BaseQuery, 179
- AddReference
  - gdcM::FileDerivation, 464
- AddReferencedFrameOfReference
  - vtkRTStructSetProperties, 1406
- AddRestriction
  - gdcM::SerieHelper, 976
- AddRoleSelectionSub
  - gdcM::network::UserInformation, 1265
- AddSegment
  - gdcM::SegmentWriter, 955
- AddSelect
  - gdcM::Sorter, 1013
- AddSeriesDirectoryRecord
  - gdcM::DICOMDIRGenerator, 357
- AddSkipTag
  - gdcM::Scanner, 931
  - gdcM::StrictScanner, 1040
- AddSOPClassExtendedNegotiationSub
  - gdcM::network::UserInformation, 1265
- AddSourceImageSequence
  - gdcM::FileDerivation, 464
- AddStructureSetROI
  - vtkRTStructSetProperties, 1406
- AddStructureSetROIObservation
  - vtkRTStructSetProperties, 1406
- AddStudyDirectoryRecord
  - gdcM::DICOMDIRGenerator, 357
- AddSurface
  - gdcM::Segment, 939
- AddTag
  - gdcM::Scanner, 931
  - gdcM::StrictScanner, 1040
- AddTransferSyntax
  - gdcM::network::PresentationContextRQ, 857
  - gdcM::PresentationContext, 847
- AdultMouseAnatomyOntology
  - gdcM::UIDs, 1172
- AdvancedBlendingPresentationStateStorage
  - gdcM::UIDs, 1173
- AE
  - gdcM::VR, 1288
- AECComp
  - gdcM, 58
- AES128\_CIPHER
  - gdcM::CryptographicMessageSyntax, 276
- AES192\_CIPHER
  - gdcM::CryptographicMessageSyntax, 276
- AES256\_CIPHER
  - gdcM::CryptographicMessageSyntax, 276
- AffectedSOPClassUID
  - gdcM::network::CEchoRQ, 238
- ALGOType
  - gdcM::Segment, 938
- ALGOType\_END
  - gdcM::Segment, 939
- Allocate
  - gdcM::LookupTable, 661
- AmbulatoryECGWaveformStorage
  - gdcM::MediaStorage, 680
  - gdcM::UIDs, 1169
- AnatomicRegion
  - gdcM::Segment, 944
- AnatomicRegionModifiers
  - gdcM::Segment, 944
- AnonymizeEvent
  - gdcM::AnonymizeEvent, 108, 109
- Anonymizer
  - gdcM::Anonymizer, 113
- Append
  - gdcM::ByteValue, 226
  - gdcM::Global, 512
- AppendFrameEncode
  - gdcM::ImageCodec, 551
  - gdcM::JPEG2000Codec, 624
  - gdcM::JPEGCodec, 635
  - gdcM::JPEGLSCodec, 644
  - gdcM::RLECodec, 921
- AppendImplementationClassUID
  - gdcM::FileMetaInformation, 473
- AppendRowEncode
  - gdcM::ImageCodec, 551
  - gdcM::JPEG2000Codec, 624
  - gdcM::JPEGCodec, 636
  - gdcM::JPEGLSCodec, 644
  - gdcM::RLECodec, 921
- AppendToDataElement
  - gdcM::FileStreamer, 495
- AppendToGroupDataElement
  - gdcM::FileStreamer, 495
- ApplicationContext
  - gdcM::network::ApplicationContext, 120
- Apply
  - gdcM::ImageApplyLookupTable, 534
- ApplyInverseVideo
  - vtkGDCMImageReader, 1309
  - vtkGDCMImageReader2, 1324

- ApplyLookupTable
  - vtkGDCMImageReader, [1310](#)
  - vtkGDCMImageReader2, [1324](#)
- ApplyPlanarConfiguration
  - vtkGDCMImageReader, [1310](#)
  - vtkGDCMImageReader2, [1324](#)
- ApplyShiftScale
  - vtkGDCMImageReader, [1310](#)
  - vtkGDCMImageReader2, [1325](#)
- ApplyYBRToRGB
  - vtkGDCMImageReader, [1310](#)
  - vtkGDCMImageReader2, [1325](#)
- Area
  - gdcm::BoxRegion, [214](#)
  - gdcm::Region, [912](#)
- AReleaseRPPDU
  - gdcm::network::AReleaseRPPDU, [125](#)
- AReleaseRQPDU
  - gdcm::network::AReleaseRQPDU, [127](#)
- AreOverlaysInPixelData
  - gdcm::Bitmap, [197](#)
  - gdcm::Pixmap, [821](#)
- ARGB
  - gdcm::PhotometricInterpretation, [808](#)
- ArrayIncludeMacrosType
  - gdcm::Macro, [668](#)
  - gdcm::Module, [706](#)
- ArrayType
  - gdcm::Attribute< Group, Element, TVR, TVM >, [136](#)
  - gdcm::Attribute< Group, Element, TVR, VM::VM1 >, [145](#)
  - gdcm::Attribute< Group, Element, TVR, VM::VM1\_n >, [154](#)
- ArterialPulseWaveformStorage
  - gdcm::UIDs, [1173](#)
- ARTIMTimer
  - gdcm::network::ARTIMTimer, [129](#)
- AS
  - gdcm::VR, [1288](#)
- ASComp
  - gdcm, [58](#)
- ASN1
  - gdcm::ASN1, [131](#)
- AsynchronousOperationsWindowSub
  - gdcm::network::AsynchronousOperationsWindowSub, [133](#)
- AT
  - gdcm::VR, [1288](#)
- Attribute
  - gdcm::Attribute< Group, Element, TVR, VM::VM1\_n >, [155](#)
  - gdcm::terminal, [85](#)
- Audio
  - gdcm::MediaStorage, [682](#)
- AudioCodec
  - gdcm::AudioCodec, [167](#)
- AudioSRStorageTrialRetired
  - gdcm::UIDs, [1170](#)
- AUTOMATIC
  - gdcm::Segment, [939](#)
- AutoPixelMinMax
  - gdcm::IconImageGenerator, [522](#)
- AutorefractionMeasurementsStorage
  - gdcm::UIDs, [1173](#)
- AXIAL
  - gdcm::Orientation, [764](#)
- backslash
  - gdcm, [63](#)
- BadBigEndian
  - gdcm::SwapCode, [1085](#)
- BadLittleEndian
  - gdcm::SwapCode, [1085](#)
- BALCPPProtect
  - gdcm::Anonymizer, [113](#)
- Base64
  - gdcm::Base64, [169](#)
- BaseQuery
  - gdcm::BaseQuery, [179](#)
- BaseRootQuery
  - gdcm::BaseRootQuery, [185](#)
- BasicAnnotationBoxSOPClass
  - gdcm::UIDs, [1168](#)
- BasicApplicationLevelConfidentialityProfile
  - gdcm::Anonymizer, [113](#)
- BasicCodedEntry
  - gdcm::SegmentHelper::BasicCodedEntry, [189](#)
- BasicCodedEntryVector
  - gdcm::Segment, [938](#)
- BasicColorImageBoxSOPClass
  - gdcm::UIDs, [1168](#)
- BasicColorPrintManagementMetaSOPClass
  - gdcm::UIDs, [1168](#)
- BasicFilmBoxSOPClass
  - gdcm::UIDs, [1168](#)
- BasicFilmSessionSOPClass
  - gdcm::UIDs, [1168](#)
- BasicGrayscaleImageBoxSOPClass
  - gdcm::UIDs, [1168](#)
- BasicGrayscalePrintManagementMetaSOPClass
  - gdcm::UIDs, [1168](#)
- BasicOffsetTable
  - gdcm::BasicOffsetTable, [192](#)
- BasicPrintImageOverlayBoxSOPClassRetired
  - gdcm::UIDs, [1168](#)
- BasicStructuredDisplayStorage
  - gdcm::UIDs, [1174](#)
- BasicStudyContentNotificationSOPClassRetired

- gdcM::UIDs, 1167
- BasicTextSR
  - gdcM::MediaStorage, 680
- BasicTextSRStorage
  - gdcM::UIDs, 1170
- BasicVoiceAudioWaveformStorage
  - gdcM::MediaStorage, 680
  - gdcM::UIDs, 1169
- Begin
  - gdcM::CSAHeaderDict, 294
  - gdcM::DataSet, 331
  - gdcM::Dict, 361
  - gdcM::IODs, 604
  - gdcM::Scanner, 931
  - gdcM::SequenceOfFragments, 960
  - gdcM::SequenceOfItems, 968
  - gdcM::StrictScanner, 1040
- BigEndian
  - gdcM::SwapCode, 1085
- Bitmap
  - gdcM::Bitmap, 197
  - gdcM::JPEG2000Codec, 629
  - gdcM::PixelFormat, 818
- BitmapToBitmapFilter
  - gdcM::BitmapToBitmapFilter, 211
- BitSample
  - gdcM::JPEGCodec, 641
  - gdcM::LookupTable, 665
- black
  - gdcM::terminal, 85
- BlendingSoftcopyPresentationStateStorageSOPClass
  - gdcM::UIDs, 1169
- blink
  - gdcM::terminal, 85
- BLUE
  - gdcM::LookupTable, 660
- blue
  - gdcM::terminal, 85
- BOOL\_FUNCTION\_PFILE\_PFILE\_POINTER
  - gdcM, 58
- BoundingBox
  - gdcM::BoxRegion, 214
- BoxRegion
  - gdcM::BoxRegion, 214
- BreakConnection
  - gdcM::network::ULConnectionManager, 1243
- BreakConnectionNow
  - gdcM::network::ULConnectionManager, 1243
- BreastImagingRelevantPatientInformationQuery
  - gdcM::UIDs, 1171
- BreastProjectionXRayImageStorageForPresentation
  - gdcM::MediaStorage, 681
  - gdcM::UIDs, 1173
- BreastProjectionXRayImageStorageForProcessing
  - gdcM::MediaStorage, 681
  - gdcM::UIDs, 1173
- BreastTomosynthesisImageStorage
  - gdcM::MediaStorage, 681
  - gdcM::UIDs, 1172
- bright
  - gdcM::terminal, 85
- Build
  - vtkLookupTable16, 1401
- ByteBuffer
  - gdcM::ByteBuffer, 218
- bytes
  - gdcM::Tag, 1116
- ByteSwap
  - gdcM::ByteSwapFilter, 222
- ByteSwapFilter
  - gdcM::ByteSwapFilter, 221, 222
- ByteValue
  - gdcM::ByteValue, 225
- C\_CANCEL\_RQ
  - gdcM::network::DIMSE, 381
- C\_ECHO\_RQ
  - gdcM::network::DIMSE, 381
- C\_ECHO\_RSP
  - gdcM::network::DIMSE, 381
- C\_FIND\_RQ
  - gdcM::network::DIMSE, 381
- C\_FIND\_RSP
  - gdcM::network::DIMSE, 381
- C\_GET\_RQ
  - gdcM::network::DIMSE, 381
- C\_GET\_RSP
  - gdcM::network::DIMSE, 381
- C\_MOVE\_RQ
  - gdcM::network::DIMSE, 381
- C\_MOVE\_RSP
  - gdcM::network::DIMSE, 381
- C\_STORE\_RQ
  - gdcM::network::DIMSE, 381
- C\_STORE\_RSP
  - gdcM::network::DIMSE, 381
- CALIBRATED
  - gdcM::Spacing, 1018
- CanCode
  - gdcM::AudioCodec, 167
  - gdcM::Coder, 251
  - gdcM::ImageCodec, 552
  - gdcM::JPEG2000Codec, 624
  - gdcM::JPEGCodec, 636
  - gdcM::JPEGLSCCodec, 644
  - gdcM::KAKADUCodec, 652
  - gdcM::PDFCodec, 796
  - gdcM::PGXCodec, 805

- gdcM::PNMCodec, [838](#)
- gdcM::PVRGCodec, [879](#)
- gdcM::RAWCodec, [899](#)
- gdcM::RLECodec, [921](#)
- CanDecode
  - gdcM::AudioCodec, [167](#)
  - gdcM::Decoder, [346](#)
  - gdcM::DeltaEncodingCodec, [353](#)
  - gdcM::ImageCodec, [552](#)
  - gdcM::JPEG2000Codec, [625](#)
  - gdcM::JPEGCodec, [636](#)
  - gdcM::JPEGLSCodec, [644](#)
  - gdcM::KAKADUCodec, [652](#)
  - gdcM::PDFCodec, [796](#)
  - gdcM::PGXCodec, [805](#)
  - gdcM::PNMCodec, [839](#)
  - gdcM::PVRGCodec, [880](#)
  - gdcM::RAWCodec, [900](#)
  - gdcM::RLECodec, [921](#)
- CanDisplay
  - gdcM::VR, [1289](#)
- CanEmptyTag
  - gdcM::Anonymizer, [114](#)
- CanRead
  - gdcM::Reader, [905](#)
- CanReadFile
  - vtkGDCMImageReader, [1301](#)
  - vtkGDCMImageReader2, [1316](#)
- CanReadImage
  - gdcM::StreamImageReader, [1026](#)
- CanStoreLossy
  - gdcM::TransferSyntax, [1136](#)
- CanWriteFile
  - gdcM::StreamImageWriter, [1031](#)
- CAPI
  - gdcM::CryptoFactory, [273](#)
- CAPICryptoFactory
  - gdcM::CAPICryptoFactory, [232](#)
- CAPICryptographicMessageSyntax
  - gdcM::CAPICryptographicMessageSyntax, [234](#)
- CardiacElectrophysiologyWaveformStorage
  - gdcM::MediaStorage, [680](#)
  - gdcM::UIDs, [1169](#)
- CardiacRelevantPatientInformationQuery
  - gdcM::UIDs, [1171](#)
- CEcho
  - gdcM::CompositeNetworkFunctions, [266](#)
- CFind
  - gdcM::CompositeNetworkFunctions, [266](#)
- Change
  - gdcM::FileChangeTransferSyntax, [458](#)
  - gdcM::FileDecompressLookupTable, [461](#)
  - gdcM::FileExplicitFilter, [468](#)
  - gdcM::ImageChangePhotometricInterpretation, [537](#)
  - gdcM::ImageChangePlanarConfiguration, [541](#)
  - gdcM::ImageChangeTransferSyntax, [546](#)
- ChangeFMI
  - gdcM::FileExplicitFilter, [468](#)
- ChangeMonochrome
  - gdcM::ImageChangePhotometricInterpretation, [538](#)
- ChangeRGB2YBR
  - gdcM::ImageChangePhotometricInterpretation, [538](#)
- ChangeYBR2RGB
  - gdcM::ImageChangePhotometricInterpretation, [538](#)
- CharacterDataHandler
  - gdcM::TableReader, [1101](#)
  - gdcM::XMLDictReader, [1426](#)
  - gdcM::XMLPrivateDictReader, [1432](#)
- CheckDataElement
  - gdcM::FileStreamer, [496](#)
- CheckEvent
  - gdcM::AnonymizeEvent, [109](#)
  - gdcM::DataEvent, [326](#)
  - gdcM::DataSetEvent, [342](#)
  - gdcM::Event, [436](#)
  - gdcM::FileNameEvent, [485](#)
  - gdcM::ProgressEvent, [876](#)
- CheckFileMetaInformationOff
  - gdcM::Writer, [1421](#)
- CheckFileMetaInformationOn
  - gdcM::Writer, [1421](#)
- CheckTemplateFileName
  - gdcM::FileStreamer, [496](#)
- ChestCADSRStorage
  - gdcM::UIDs, [1170](#)
- CipherTypes
  - gdcM::CryptographicMessageSyntax, [275](#)
- Clamp
  - gdcM, [63](#)
- clean
  - gdcM, [63](#)
- CleanupUnusedBits
  - gdcM::ImageCodec, [552](#)
- Clear
  - gdcM::Bitmap, [197](#)
  - gdcM::ByteValue, [226](#)
  - gdcM::DataElement, [313](#)
  - gdcM::DataSet, [331](#)
  - gdcM::IOD, [598](#)
  - gdcM::IODs, [604](#)
  - gdcM::Item, [612](#)
  - gdcM::LookupTable, [661](#)
  - gdcM::Macro, [669](#)
  - gdcM::Macros, [671](#)
  - gdcM::Module, [706](#)
  - gdcM::Modules, [714](#)
  - gdcM::Preamble, [842](#)
  - gdcM::SequenceOfFragments, [960](#)

- gdcM::SequenceOfItems, 968
- gdcM::SerieHelper, 976
- gdcM::Value, 1271
- vtkGDCMMedicalImageProperties, 1338
- vtkRTStructSetProperties, 1406
- ClearInternalUIDs
  - gdcM::Anonymizer, 114
- ClearSkipTags
  - gdcM::Scanner, 931
  - gdcM::StrictScanner, 1040
- ClearTags
  - gdcM::Scanner, 931
  - gdcM::StrictScanner, 1040
- Clone
  - gdcM::BoxRegion, 215
  - gdcM::ImageCodec, 552
  - gdcM::JPEG2000Codec, 625
  - gdcM::JPEGCodec, 636
  - gdcM::JPEGLSCodec, 645
  - gdcM::KAKADUCodec, 652
  - gdcM::PGXCodec, 805
  - gdcM::PNMCodec, 839
  - gdcM::PVRGCodec, 880
  - gdcM::RAWCodec, 900
  - gdcM::Region, 913
  - gdcM::RLECodec, 922
- CM
  - gdcM::SegmentHelper::BasicCodedEntry, 190
- cMaxEventID
  - gdcM::network, 83
- cMaxStateID
  - gdcM::network, 83
- CMove
  - gdcM::CompositeNetworkFunctions, 267
- CMYK
  - gdcM::PhotometricInterpretation, 808
- Code
  - gdcM::Coder, 251
  - gdcM::JPEG2000Codec, 625
  - gdcM::JPEGCodec, 637
  - gdcM::JPEGLSCodec, 645
  - gdcM::JSON, 649
  - gdcM::KAKADUCodec, 653
  - gdcM::PVRGCodec, 880
  - gdcM::RAWCodec, 900
  - gdcM::RLECodec, 922
- CodeMeaning
  - gdcM::RealWorldValueMappingContent, 910
- CodeString
  - gdcM::CodeString, 254, 255
- CodeValue
  - gdcM::RealWorldValueMappingContent, 910
- ColonCADSRStorage
  - gdcM::UIDs, 1174
- Color
  - gdcM::terminal, 85
- ColorArray
  - gdcM::SurfaceHelper, 1075
- ColorPaletteQueryRetrieveInformationModelFIND
  - gdcM::UIDs, 1175
- ColorPaletteQueryRetrieveInformationModelGET
  - gdcM::UIDs, 1175
- ColorPaletteQueryRetrieveInformationModelMOVE
  - gdcM::UIDs, 1175
- ColorPaletteStorage
  - gdcM::UIDs, 1175
- ColorSoftcopyPresentationStateStorageSOPClass
  - gdcM::UIDs, 1169
- Command
  - gdcM::Command, 258, 259
- CommandDataSet
  - gdcM::CommandDataSet, 261
- CommandTypes
  - gdcM::network::DIMSE, 381
- Compatible
  - gdcM::VM, 1284
  - gdcM::VR, 1290
- Component
  - gdcM::PersonName, 802
- CompOperators
  - gdcM, 60
- CompositeInstanceRetrieveWithoutBulkDataGET
  - gdcM::UIDs, 1174
- CompositeInstanceRootRetrieveGET
  - gdcM::UIDs, 1174
- CompositeInstanceRootRetrieveMOVE
  - gdcM::UIDs, 1174
- CompositingPlanarMPRVolumetricPresentationStateStorage
  - gdcM::UIDs, 1173
- Comprehensive3DSRStorage
  - gdcM::UIDs, 1174
- ComprehensiveSR
  - gdcM::MediaStorage, 680
- ComprehensiveSRStorage
  - gdcM::UIDs, 1170
- ComprehensiveSRStorageTrialRetired
  - gdcM::UIDs, 1170
- CompressionTypes
  - vtkGDCMImageWriter, 1330
- Compute
  - gdcM::EquipmentManufacturer, 434
  - gdcM::MD5, 675
  - gdcM::SHA1, 991
- ComputeBoundingBox
  - gdcM::BoxRegion, 215
  - gdcM::Region, 913
- ComputeBufferLength
  - gdcM::ImageRegionReader, 580

- ComputeByteLength
  - gdcM::SequenceOfFragments, [960](#)
- ComputeDataElement
  - gdcM::DataSet, [331](#)
- ComputeDataSetMediaStorageSOPClass
  - gdcM::FileMetaInformation, [473](#)
- ComputeDataSetTransferSyntax
  - gdcM::FileMetaInformation, [473](#)
- ComputeDistAlongNormal
  - gdcM::DirectionCosines, [383](#)
- ComputedRadiographyImageStorage
  - gdcM::MediaStorage, [679](#)
  - gdcM::UIDs, [1168](#)
- ComputeFile
  - gdcM::MD5, [675](#)
  - gdcM::SHA1, [991](#)
- ComputeFileMD5
  - gdcM::Testing, [1121](#)
- ComputeGroupLength
  - gdcM::DataSet, [331](#)
- ComputeInterceptSlopePixelType
  - gdcM::Rescaler, [916](#)
- ComputeLength
  - gdcM::ByteValue, [226](#)
  - gdcM::Fragment, [508](#)
  - gdcM::SequenceOfFragments, [960](#)
  - gdcM::SequenceOfItems, [969](#)
- ComputeLossyFlag
  - gdcM::Bitmap, [197](#)
- ComputeMD5
  - gdcM::Testing, [1121](#)
- ComputeMediaStorageFromModality
  - gdcM::ImageHelper, [568](#)
- ComputeMOSAICDimensions
  - gdcM::SplitMosaicFilter, [1020](#)
- ComputeMOSAICSliceNormal
  - gdcM::SplitMosaicFilter, [1020](#)
- ComputeMOSAICSlicePosition
  - gdcM::SplitMosaicFilter, [1021](#)
- ComputeNumberOfSurfaces
  - gdcM::SurfaceWriter, [1082](#)
- ComputeOffsetTable
  - gdcM::JPEGCodec, [637](#)
- ComputePixelAspectRatioFromPixelSpacing
  - gdcM::Spacing, [1018](#)
- ComputePixelTypeFromMinMax
  - gdcM::Rescaler, [916](#)
- ComputeSpacingFromImagePositionPatient
  - gdcM::ImageHelper, [568](#)
- ComputeTargetMediaStorage
  - gdcM::ImageWriter, [587](#)
- ComputeVR
  - gdcM::DataSetHelper, [344](#)
- ComputeZSpacing
  - gdcM::IPPSorter, [609](#)
- ConcatenatePDVBlobs
  - gdcM::network::PresentationDataValue, [860](#)
- ConcatenatePDVBlobsAsExplicit
  - gdcM::network::PresentationDataValue, [860](#)
- CONDENSED\_STYLE
  - gdcM::Printer, [865](#)
- Conditional
  - gdcM::Usage, [1261](#)
- CONSOLE
  - gdcM::terminal, [86](#)
- const
  - gdcM::SOPClassUIDToIOD, [1009](#)
- const\_iterator
  - gdcM::CodeString, [253](#)
  - gdcM::LO, [655](#)
  - gdcM::String< TDelimiter, TMaxLength, TPadChar >, [1047](#)
- const\_reference
  - gdcM::CodeString, [253](#)
  - gdcM::LO, [655](#)
  - gdcM::String< TDelimiter, TMaxLength, TPadChar >, [1047](#)
- const\_reverse\_iterator
  - gdcM::CodeString, [253](#)
  - gdcM::LO, [655](#)
  - gdcM::String< TDelimiter, TMaxLength, TPadChar >, [1047](#)
- ConstCharWrapper
  - gdcM::ConstCharWrapper, [269](#)
- ConstIterator
  - gdcM::CSAHeaderDict, [293](#)
  - gdcM::DataSet, [330](#)
  - gdcM::Dict, [360](#)
  - gdcM::Scanner, [929](#)
  - gdcM::SequenceOfFragments, [959](#)
  - gdcM::SequenceOfItems, [967](#)
  - gdcM::StrictScanner, [1038](#)
- Construct
  - gdcM::BaseRootQuery, [185](#)
- ConstructAbortPDU
  - gdcM::network::PDUFactory, [798](#)
- ConstructCEchoRQ
  - gdcM::network::CompositeMessageFactory, [263](#)
- ConstructCFindRQ
  - gdcM::network::CompositeMessageFactory, [263](#)
- ConstructCMoveRQ
  - gdcM::network::CompositeMessageFactory, [263](#)
- ConstructCStoreRQ
  - gdcM::network::CompositeMessageFactory, [264](#)
- ConstructCStoreRSP
  - gdcM::network::CompositeMessageFactory, [264](#)
- ConstructFromString
  - gdcM::TagPath, [1117](#)



- ConstructFromTagList
    - gdcM::TagPath, 1117
  - ConstructNAAction
    - gdcM::network::NormalizedMessageFactory, 742
  - ConstructNCreate
    - gdcM::network::NormalizedMessageFactory, 742
  - ConstructNDelete
    - gdcM::network::NormalizedMessageFactory, 742
  - ConstructNEventReport
    - gdcM::network::NormalizedMessageFactory, 743
  - ConstructNGet
    - gdcM::network::NormalizedMessageFactory, 743
  - ConstructNSet
    - gdcM::network::NormalizedMessageFactory, 743
  - ConstructorType
    - gdcM::Dicts, 377
  - ConstructPDU
    - gdcM::network::PDUFactory, 798
  - ConstructPDV
    - gdcM::network::BaseCompositeMessage, 172
    - gdcM::network::BaseNormalizedMessage, 174
    - gdcM::network::CEchoRQ, 238
    - gdcM::network::CFindRQ, 243
    - gdcM::network::CMoveRQ, 247
    - gdcM::network::CStoreRQ, 301
    - gdcM::network::CStoreRSP, 302
    - gdcM::network::NAActionRQ, 724
    - gdcM::network::NCreateRQ, 727
    - gdcM::network::NDeleteRQ, 730
    - gdcM::network::NEventReportRQ, 736
    - gdcM::network::NGetRQ, 739
    - gdcM::network::NSetRQ, 747
  - ConstructPDVByDataSet
    - gdcM::network::CEchoRSP, 240
    - gdcM::network::CFindCancelRQ, 241
    - gdcM::network::CFindRSP, 244
    - gdcM::network::CMoveCancelRq, 245
    - gdcM::network::CMoveRSP, 248
    - gdcM::network::NAActionRSP, 725
    - gdcM::network::NCreateRSP, 728
    - gdcM::network::NDeleteRSP, 731
    - gdcM::network::NEventReportRSP, 737
    - gdcM::network::NGetRSP, 740
    - gdcM::network::NSetRSP, 749
  - ConstructQuery
    - gdcM::CompositeNetworkFunctions, 267, 268
    - gdcM::NormalizedNetworkFunctions, 744
  - ConstructReleasePDU
    - gdcM::network::PDUFactory, 798
  - ContentAssessmentResultsStorage
    - gdcM::UIDs, 1174
  - Convert
    - gdcM::DictConverter, 365
    - gdcM::ImageConverter, 563
  - ConvertRGBToPaletteColor
    - gdcM::IconImageGenerator, 522
  - ConvertToCXX
    - gdcM::DictConverter, 366
  - ConvertToUNC
    - gdcM::System, 1089
  - ConvertToXML
    - gdcM::DictConverter, 366
  - CornealTopographyMapStorage
    - gdcM::UIDs, 1174
  - CORONAL
    - gdcM::Orientation, 764
  - Create
    - gdcM::Preamble, 842
  - CreateCEchoPDU
    - gdcM::network::PDUFactory, 798
  - CreateCFindPDU
    - gdcM::network::PDUFactory, 798
  - CreateCMovePDU
    - gdcM::network::PDUFactory, 798
  - CreateCMSProvider
    - gdcM::CAPICryptoFactory, 233
    - gdcM::CryptoFactory, 274
    - gdcM::OpenSSLCryptoFactory, 754
    - gdcM::OpenSSLP7CryptoFactory, 759
  - CreateCStoreRQPDU
    - gdcM::network::PDUFactory, 799
  - CreateCStoreRSPPDU
    - gdcM::network::PDUFactory, 799
  - CreateDefaultUniqueSeriesIdentifier
    - gdcM::SerieHelper, 976
  - CreateNAActionPDU
    - gdcM::network::PDUFactory, 799
  - CreateNCreatePDU
    - gdcM::network::PDUFactory, 799
  - CreateNDeletePDU
    - gdcM::network::PDUFactory, 799
  - CreateNEventReportPDU
    - gdcM::network::PDUFactory, 799
  - CreateNGetPDU
    - gdcM::network::PDUFactory, 800
  - CreateNSetPDU
    - gdcM::network::PDUFactory, 800
  - CreateUniqueSeriesIdentifier
    - gdcM::SerieHelper, 977
- Cross
  - gdcM::DirectionCosines, 383
- CrossDot
  - gdcM::DirectionCosines, 383
- CryptoFactory
  - gdcM::CryptoFactory, 274
- CryptographicMessageSyntax
  - gdcM::CryptographicMessageSyntax, 276
- CryptoLib

- gdcM::CryptoFactory, [273](#)
- CS
  - gdcM::VR, [1288](#)
- CSAElement
  - gdcM::CSAElement, [280](#)
- CSAHeader
  - gdcM::CSAHeader, [288](#)
  - gdcM::DataSet, [339](#)
- CSAHeaderDict
  - gdcM::CSAHeaderDict, [293](#), [294](#)
- CSAHeaderDictEntry
  - gdcM::CSAHeaderDictEntry, [296](#)
- CSAHeaderType
  - gdcM::CSAHeader, [288](#)
- CSANonImageStorage
  - gdcM::MediaStorage, [680](#)
- CSComp
  - gdcM, [58](#)
- CSD
  - gdcM::SegmentHelper::BasicCodedEntry, [190](#)
- CStore
  - gdcM::CompositeNetworkFunctions, [268](#)
- CSV
  - gdcM::SegmentHelper::BasicCodedEntry, [190](#)
- CT\_private\_ELE
  - gdcM::TransferSyntax, [1135](#)
- CTDefinedProcedureProtocolStorage
  - gdcM::UIDs, [1174](#)
- CTImageStorage
  - gdcM::MediaStorage, [679](#)
  - gdcM::UIDs, [1168](#)
- CTPerformedProcedureProtocolStorage
  - gdcM::UIDs, [1174](#)
- Curve
  - gdcM::Curve, [304](#), [305](#)
  - vtkGDCMImageReader, [1310](#)
  - vtkGDCMImageReader2, [1325](#)
- Curves
  - gdcM::Pixmap, [824](#)
- CV
  - gdcM::SegmentHelper::BasicCodedEntry, [191](#)
- CXX
  - gdcM::Printer, [865](#)
- cyan
  - gdcM::terminal, [85](#)
- DA
  - gdcM::VR, [1288](#)
- DAComp
  - gdcM, [58](#)
- DataElement
  - gdcM::DataElement, [312](#), [313](#)
  - gdcM::Value, [1272](#)
- DataElementSet
  - gdcM::DataSet, [330](#)
- DataElementType
  - gdcM::ModuleEntry, [712](#)
- DataEvent
  - gdcM::DataEvent, [325](#), [326](#)
- DataField
  - gdcM::CSAElement, [285](#)
- DataPtr
  - gdcM::CSAElement, [280](#)
- DATASET\_FORMAT
  - gdcM::CSAHeader, [288](#)
- DataSetEvent
  - gdcM::DataSetEvent, [342](#)
- DataSetHandled
  - gdcM::network::ULConnectionCallback, [1237](#)
- DataSetHandles
  - gdcM::network::ULConnectionCallback, [1237](#)
- DataSetMS
  - gdcM::FileMetaInformation, [479](#)
- DataSetTS
  - gdcM::FileMetaInformation, [479](#)
- DataWasPassed
  - vtkImageMapToColors16, [1387](#)
- dCor
  - gdcM::MrProtocol::Vector3, [1274](#)
- DebugOff
  - gdcM::Trace, [1128](#)
- DebugOn
  - gdcM::Trace, [1128](#)
- Decode
  - gdcM::AudioCodec, [168](#)
  - gdcM::Base64, [169](#)
  - gdcM::Curve, [305](#)
  - gdcM::Decoder, [346](#)
  - gdcM::DeltaEncodingCodec, [353](#)
  - gdcM::ImageCodec, [553](#)
  - gdcM::JPEG2000Codec, [625](#)
  - gdcM::JPEGCodec, [637](#)
  - gdcM::JPEGLSCoDec, [645](#)
  - gdcM::JSON, [649](#)
  - gdcM::KAKADUCoDec, [653](#)
  - gdcM::LookupTable, [661](#)
  - gdcM::PDFCoDec, [796](#)
  - gdcM::PVRGCoDec, [880](#)
  - gdcM::RAWCoDec, [900](#)
  - gdcM::RLECoDec, [922](#)
- Decode8
  - gdcM::LookupTable, [661](#)
- DecodeByStreams
  - gdcM::Decoder, [346](#)
  - gdcM::ImageCodec, [553](#)
  - gdcM::JPEG12CoDec, [617](#)
  - gdcM::JPEG16CoDec, [620](#)
  - gdcM::JPEG2000CoDec, [626](#)



- gdcM::JPEG8Codec, [631](#)
- gdcM::JPEGCodec, [637](#)
- gdcM::RAWCodec, [901](#)
- gdcM::RLECodec, [922](#)
- DecodeBytes
  - gdcM::RAWCodec, [901](#)
- DecodeExtent
  - gdcM::JPEG2000Codec, [626](#)
  - gdcM::JPEGCodec, [637](#)
  - gdcM::JPEGLSCoDec, [646](#)
  - gdcM::RLECodec, [923](#)
- Decompress
  - gdcM::Overlay, [770](#)
- Decrypt
  - gdcM::CAPICryptographicMessageSyntax, [235](#)
  - gdcM::CryptographicMessageSyntax, [276](#)
  - gdcM::OpenSSLCryptographicMessageSyntax, [756](#)
  - gdcM::OpenSSL7CryptographicMessageSyntax, [761](#)
- DeepCopy
  - vtkRTStructSetProperties, [1406](#)
- DEFAULT
  - gdcM::CryptoFactory, [273](#)
- Default
  - gdcM::FileMetaInformation, [473](#)
- DefinedProcedureProtocolInformationModelFIND
  - gdcM::UIDs, [1174](#)
- DefinedProcedureProtocolInformationModelGET
  - gdcM::UIDs, [1174](#)
- DefinedProcedureProtocolInformationModelMOVE
  - gdcM::UIDs, [1174](#)
- DefinedTerms
  - gdcM::DefinedTerms, [347](#)
- DefinePixelExtent
  - gdcM::StreamImageReader, [1026](#)
  - gdcM::StreamImageWriter, [1031](#)
- DefineProperBufferLength
  - gdcM::StreamImageReader, [1026](#)
  - gdcM::StreamImageWriter, [1031](#)
- DeflatedExplicitVRLittleEndian
  - gdcM::TransferSyntax, [1135](#)
  - gdcM::UIDs, [1166](#)
- DeformableSpatialRegistrationStorage
  - gdcM::UIDs, [1169](#)
- Defs
  - gdcM::Defs, [348](#), [349](#)
- DeleteDirectory
  - gdcM::System, [1089](#)
- DeltaEncodingCodec
  - gdcM::DeltaEncodingCodec, [353](#)
- Derive
  - gdcM::FileDerivation, [465](#)
- DES3\_CIPHER
  - gdcM::CryptographicMessageSyntax, [276](#)
- Description
  - gdcM::ModuleEntry, [710](#)
- DescriptionField
  - gdcM::ModuleEntry, [712](#)
- DetachedInterpretationManagementSOPClassRetired
  - gdcM::UIDs, [1168](#)
- DetachedPatientManagementMetaSOPClassRetired
  - gdcM::UIDs, [1167](#)
- DetachedPatientManagementSOPClass
  - gdcM::MediaStorage, [680](#)
- DetachedPatientManagementSOPClassRetired
  - gdcM::UIDs, [1167](#)
- DetachedResultsManagementMetaSOPClassRetired
  - gdcM::UIDs, [1167](#)
- DetachedResultsManagementSOPClassRetired
  - gdcM::UIDs, [1167](#)
- DetachedStudyManagementMetaSOPClassRetired
  - gdcM::UIDs, [1167](#)
- DetachedStudyManagementSOPClass
  - gdcM::MediaStorage, [680](#)
- DetachedStudyManagementSOPClassRetired
  - gdcM::UIDs, [1167](#)
- DetachedVisitManagementSOPClass
  - gdcM::MediaStorage, [680](#)
- DetachedVisitManagementSOPClassRetired
  - gdcM::UIDs, [1167](#)
- DetailSRStorageTrialRetired
  - gdcM::UIDs, [1170](#)
- DETECTOR
  - gdcM::Spacing, [1018](#)
- DetermineEventByPDU
  - gdcM::network::PDUFactory, [800](#)
- dicomAETitle
  - gdcM::UIDs, [1171](#)
- dicomApplicationCluster
  - gdcM::UIDs, [1171](#)
- DICOMApplicationContextName
  - gdcM::UIDs, [1167](#)
- dicomAssociationAcceptor
  - gdcM::UIDs, [1171](#)
- dicomAssociationInitiator
  - gdcM::UIDs, [1171](#)
- dicomAuthorizedNodeCertificateReference
  - gdcM::UIDs, [1171](#)
- dicomConfigurationRoot
  - gdcM::UIDs, [1172](#)
- DICOMContentMappingResource
  - gdcM::UIDs, [1175](#)
- DICOMControlledTerminology
  - gdcM::UIDs, [1167](#)
- dicomDescription
  - gdcM::UIDs, [1171](#)
- dicomDevice
  - gdcM::UIDs, [1172](#)

dicomDeviceName  
     gdcM::UIDs, 1171  
 dicomDeviceSerialNumber  
     gdcM::UIDs, 1172  
 dicomDevicesRoot  
     gdcM::UIDs, 1172  
 DICOMDIR  
     gdcM::DICOMDIR, 354  
 DICOMDIRGenerator  
     gdcM::DICOMDIRGenerator, 356  
 dicomHostname  
     gdcM::UIDs, 1171  
 dicomInstalled  
     gdcM::UIDs, 1171  
 dicomInstitutionAddress  
     gdcM::UIDs, 1172  
 dicomInstitutionDepartmentName  
     gdcM::UIDs, 1172  
 dicomInstitutionName  
     gdcM::UIDs, 1172  
 dicomIssuerOfPatientID  
     gdcM::UIDs, 1172  
 dicomManufacturer  
     gdcM::UIDs, 1171  
 dicomManufacturerModelName  
     gdcM::UIDs, 1171  
 dicomNetworkAET  
     gdcM::UIDs, 1172  
 dicomNetworkConnection  
     gdcM::UIDs, 1172  
 dicomNetworkConnectionReference  
     gdcM::UIDs, 1171  
 dicomPort  
     gdcM::UIDs, 1171  
 dicomPreferredCalledAETitle  
     gdcM::UIDs, 1171  
 dicomPreferredCallingAETitle  
     gdcM::UIDs, 1172  
 dicomPrimaryDeviceType  
     gdcM::UIDs, 1171  
 dicomRelatedDeviceReference  
     gdcM::UIDs, 1171  
 dicomSoftwareVersion  
     gdcM::UIDs, 1171  
 dicomSOPClass  
     gdcM::UIDs, 1171  
 dicomStationName  
     gdcM::UIDs, 1172  
 dicomSupportedCharacterSet  
     gdcM::UIDs, 1172  
 dicomThisNodeCertificateReference  
     gdcM::UIDs, 1171  
 dicomTLSCyphersuite  
     gdcM::UIDs, 1171  
 dicomTransferCapability  
     gdcM::UIDs, 1172  
 dicomTransferRole  
     gdcM::UIDs, 1171  
 dicomTransferSyntax  
     gdcM::UIDs, 1171  
 DICOMUIDRegistry  
     gdcM::UIDs, 1167  
 dicomUniqueAETitle  
     gdcM::UIDs, 1172  
 dicomUniqueAETitlesRegistryRoot  
     gdcM::UIDs, 1172  
 dicomVendorData  
     gdcM::UIDs, 1171  
 DICOS2DAITStorage  
     gdcM::UIDs, 1174  
 DICOS3DAITStorage  
     gdcM::UIDs, 1174  
 DICOSCTImageStorage  
     gdcM::UIDs, 1174  
 DICOSDigitalXRayImageStorageForPresentation  
     gdcM::UIDs, 1174  
 DICOSDigitalXRayImageStorageForProcessing  
     gdcM::UIDs, 1174  
 DICOSQuadrupoleResonanceQRStorage  
     gdcM::UIDs, 1174  
 DICOSThreatDetectionReportStorage  
     gdcM::UIDs, 1174  
 Dict  
     gdcM::Dict, 360, 361  
     gdcM::DictEntry, 372  
 DICT\_DEBUG  
     gdcM::DictConverter, 365  
 DICT\_DEFAULT  
     gdcM::DictConverter, 365  
 DICT\_XML  
     gdcM::DictConverter, 365  
 DictConverter  
     gdcM::DictConverter, 365  
 DictEntry  
     gdcM::DictEntry, 369  
 DictPrinter  
     gdcM::DictPrinter, 374  
 Dicts  
     gdcM::CSAHeaderDict, 295  
     gdcM::Dict, 363  
     gdcM::Dicts, 377  
     gdcM::PrivateDict, 871  
 difference\_type  
     gdcM::CodeString, 253  
     gdcM::LO, 655  
     gdcM::String< TDelimiter, TMaxLength, TPadChar  
         >, 1047  
 DigitalIntraoralXRayImageStorageForPresentation

- gdcM::UIDs, 1168
- DigitalIntraoralXRayImageStorageForPresentation
  - gdcM::MediaStorage, 679
- DigitalIntraoralXRayImageStorageForProcessing
  - gdcM::MediaStorage, 679
  - gdcM::UIDs, 1168
- DigitalMammographyImageStorageForPresentation
  - gdcM::MediaStorage, 679
- DigitalMammographyImageStorageForProcessing
  - gdcM::MediaStorage, 679
- DigitalMammographyXRayImageStorageForPresentation
  - gdcM::UIDs, 1168
- DigitalMammographyXRayImageStorageForProcessing
  - gdcM::UIDs, 1168
- DigitalXRayImageStorageForPresentation
  - gdcM::MediaStorage, 679
  - gdcM::UIDs, 1168
- DigitalXRayImageStorageForProcessing
  - gdcM::MediaStorage, 679
  - gdcM::UIDs, 1168
- dim
  - gdcM::terminal, 85
- Dimensions
  - gdcM::Bitmap, 208
  - gdcM::ImageCodec, 560
- DirCosTolerance
  - gdcM::IPPSorter, 609
- DirectionCosines
  - gdcM::DirectionCosines, 383
  - vtkGDCMImageReader, 1310
  - vtkGDCMImageReader2, 1325
- Directory
  - gdcM::Directory, 387
- DisplaySystemSOPClass
  - gdcM::UIDs, 1173
- DisplaySystemSOPInstance
  - gdcM::UIDs, 1173
- DoByteSwap
  - gdcM::ImageCodec, 553
- DolconImage
  - gdcM::PixmapWriter, 834
- DolInvertMonochrome
  - gdcM::ImageCodec, 553
- DoOverlayCleanup
  - gdcM::ImageCodec, 554
- DoPaddedCompositePixelCode
  - gdcM::ImageCodec, 554
- DoPlanarConfiguration
  - gdcM::ImageCodec, 554
- doround
  - gdcM, 64
- DoSimpleCopy
  - gdcM::ImageCodec, 554
- Dot
  - gdcM::DirectionCosines, 384
- DoYBR
  - gdcM::ImageCodec, 554
- DoYBRFull422
  - gdcM::ImageCodec, 554
- DropDuplicatePositions
  - gdcM::IPPSorter, 610
- DS
  - gdcM::VR, 1288
- dSag
  - gdcM::MrProtocol::Vector3, 1274
- DT
  - gdcM::VR, 1288
- DTComp
  - gdcM, 58
- dTra
  - gdcM::MrProtocol::Vector3, 1274
- Dumper
  - gdcM::Dumper, 394
- DuplicateAttributeError
  - gdcM::Parser, 782
- eAABORTPDUReturnedOpen
  - gdcM::network, 81
- eAABORTRequest
  - gdcM::network, 81
- eAASSOCIATE\_RQPDUreceived
  - gdcM::network, 81
- eAASSOCIATERequestLocalUser
  - gdcM::network, 81
- eAASSOCIATEresponseAccept
  - gdcM::network, 81
- eAASSOCIATEresponseReject
  - gdcM::network, 81
- eArabic
  - gdcM, 61
- eARELEASE\_RPPDUreceived
  - gdcM::network, 81
- eARELEASE\_RQPDUreceivedOpen
  - gdcM::network, 81
- eARELEASERequest
  - gdcM::network, 81
- eARELEASEResponse
  - gdcM::network, 81
- eARTIMTimerExpired
  - gdcM::network, 81
- eASSOCIATE\_ACPDUreceived
  - gdcM::network, 81
- eASSOCIATE\_RJPDUreceived
  - gdcM::network, 81
- ECG12leadWaveformStorage
  - gdcM::UIDs, 1169
- ECharSet
  - gdcM, 61

- eCreateMMPS
  - gdcm, [62](#)
- eCyrillic
  - gdcm, [61](#)
- EddyCurrentImageStorage
  - gdcm::UIDs, [1174](#)
- EddyCurrentMultiframeImageStorage
  - gdcm::UIDs, [1174](#)
- EDGE
  - gdcm::MeshPrimitive, [695](#)
- eEventDoesNotExist
  - gdcm::network, [81](#)
- EEventID
  - gdcm::network, [81](#)
- eFind
  - gdcm, [62](#)
- eGB18030
  - gdcm, [61](#)
- eGreek
  - gdcm, [61](#)
- eHebrew
  - gdcm, [61](#)
- elImage
  - gdcm, [62](#)
- eJapanese
  - gdcm, [61](#)
- eJapaneseKanjiMultibyte
  - gdcm, [61](#)
- eJapaneseSupplementaryKanjiMultibyte
  - gdcm, [61](#)
- eKoreanHangulHanjaMultibyte
  - gdcm, [61](#)
- eLatin1
  - gdcm, [61](#)
- eLatin2
  - gdcm, [61](#)
- eLatin3
  - gdcm, [61](#)
- eLatin4
  - gdcm, [61](#)
- eLatin5
  - gdcm, [61](#)
- elem
  - gdcm::SerieHelper, [978](#)
- Element
  - gdcm::Element< TVR, VM::VM1\_n >, [404](#)
- eMove
  - gdcm, [62](#)
- Empty
  - gdcm::Anonymizer, [114](#)
  - gdcm::BoxRegion, [215](#)
  - gdcm::DataElement, [313](#)
  - gdcm::FileAnonymizer, [454](#)
  - gdcm::Region, [913](#)
- EmptyMaskGenerator
  - gdcm::EmptyMaskGenerator, [425](#)
- EncapsulatedCDASStorage
  - gdcm::MediaStorage, [680](#)
  - gdcm::UIDs, [1170](#)
- EncapsulatedDocument
  - gdcm::EncapsulatedDocument, [427](#)
- EncapsulatedPDFStorage
  - gdcm::MediaStorage, [680](#)
  - gdcm::UIDs, [1170](#)
- EncapsulatedSTLStorage
  - gdcm::UIDs, [1174](#)
- Encode
  - gdcm::Base64, [169](#)
- EncodeBuffer
  - gdcm::JPEG12Codec, [618](#)
  - gdcm::JPEG16Codec, [621](#)
  - gdcm::JPEG8Codec, [631](#)
  - gdcm::JPEGCodec, [638](#)
- EncodeBytes
  - gdcm::System, [1090](#)
- Encrypt
  - gdcm::CAPICryptographicMessageSyntax, [235](#)
  - gdcm::CryptographicMessageSyntax, [276](#)
  - gdcm::OpenSSLCryptographicMessageSyntax, [756](#)
  - gdcm::OpenSSLP7CryptographicMessageSyntax, [761](#)
- End
  - gdcm::CSAHeaderDict, [294](#)
  - gdcm::DataSet, [331](#), [332](#)
  - gdcm::Dict, [361](#)
  - gdcm::IODs, [604](#)
  - gdcm::Scanner, [931](#)
  - gdcm::SequenceOfFragments, [960](#), [961](#)
  - gdcm::SequenceOfItems, [969](#)
  - gdcm::StrictScanner, [1040](#)
- EndElement
  - gdcm::TableReader, [1101](#)
  - gdcm::XMLDictReader, [1426](#)
  - gdcm::XMLPrivateDictReader, [1433](#)
- EndElementHandler
  - gdcm::Parser, [780](#)
- EndFilter
  - gdcm::SimpleSubjectWatcher, [998](#)
- EndWith
  - gdcm::Filename, [481](#)
- EnhancedCTImageStorage
  - gdcm::MediaStorage, [679](#)
  - gdcm::UIDs, [1168](#)
- EnhancedMRColorImageStorage
  - gdcm::MediaStorage, [681](#)
  - gdcm::UIDs, [1175](#)
- EnhancedMRImageStorage
  - gdcm::MediaStorage, [680](#)

- gdcM::UIDs, [1168](#)
- EnhancedPETImageStorage
  - gdcM::MediaStorage, [681](#)
  - gdcM::UIDs, [1174](#)
- EnhancedSR
  - gdcM::MediaStorage, [680](#)
- EnhancedSRStorage
  - gdcM::UIDs, [1170](#)
- EnhancedUSVolumeStorage
  - gdcM::MediaStorage, [681](#)
  - gdcM::UIDs, [1172](#)
- EnhancedXAImageStorage
  - gdcM::MediaStorage, [681](#)
  - gdcM::UIDs, [1169](#)
- EnhancedXRFImageStorage
  - gdcM::UIDs, [1169](#)
- ENQueryType
  - gdcM, [61](#)
- EnumeratedValues
  - gdcM::EnumeratedValues, [432](#)
- ePatient
  - gdcM, [62](#)
- ePatientRootType
  - gdcM, [62](#)
- ePDATArequest
  - gdcM::network, [81](#)
- ePDATATFPDU
  - gdcM::network, [81](#)
- EQueryLevel
  - gdcM, [62](#)
- EQueryType
  - gdcM, [62](#)
- ERootType
  - gdcM, [62](#)
- ErrorOff
  - gdcM::Trace, [1129](#)
- ErrorOn
  - gdcM::Trace, [1129](#)
- ErrorType
  - gdcM::Parser, [781](#)
- eSeries
  - gdcM, [62](#)
- eSetMMPS
  - gdcM, [62](#)
- eSta10ReleaseCollisionAc
  - gdcM::network, [83](#)
- eSta11ReleaseCollisionRq
  - gdcM::network, [83](#)
- eSta12ReleaseCollisionAcLocal
  - gdcM::network, [83](#)
- eSta13AwaitingClose
  - gdcM::network, [83](#)
- eSta1Idle
  - gdcM::network, [83](#)
- eSta2Open
  - gdcM::network, [83](#)
- eSta3WaitLocalAssoc
  - gdcM::network, [83](#)
- eSta4LocalAssocDone
  - gdcM::network, [83](#)
- eSta5WaitRemoteAssoc
  - gdcM::network, [83](#)
- eSta6TransferReady
  - gdcM::network, [83](#)
- eSta7WaitRelease
  - gdcM::network, [83](#)
- eSta8WaitLocalRelease
  - gdcM::network, [83](#)
- eSta9ReleaseCollisionRqLocal
  - gdcM::network, [83](#)
- EstablishConnection
  - gdcM::network::ULConnectionManager, [1243](#)
- EstablishConnectionMove
  - gdcM::network::ULConnectionManager, [1243](#)
- eStaDoesNotExist
  - gdcM::network, [83](#)
- EStateID
  - gdcM::network, [81](#)
- eStudy
  - gdcM, [62](#)
- eStudyRootType
  - gdcM, [62](#)
- eThai
  - gdcM, [61](#)
- eTransportConnConfirmLocal
  - gdcM::network, [81](#)
- eTransportConnectionClosed
  - gdcM::network, [81](#)
- eTransportConnIndicLocal
  - gdcM::network, [81](#)
- eUnrecognizedPDUReceived
  - gdcM::network, [81](#)
- eUTF8
  - gdcM, [61](#)
- Event
  - gdcM::Event, [436](#)
- eWLMFind
  - gdcM, [62](#)
- Exception
  - gdcM::Exception, [439](#)
- Execute
  - gdcM::Command, [259](#)
  - gdcM::EmptyMaskGenerator, [425](#)
  - gdcM::MemberCommand< T >, [690](#)
  - gdcM::SimpleMemberCommand< T >, [995](#)
- ExecuteData
  - vtkGDCMImageReader, [1301](#)
  - vtkGDCMThreadedImageReader, [1356](#)

- ExecuteInformation
  - vtkGDCMImageReader, 1302
  - vtkGDCMThreadedImageReader, 1356
- ExecuteQuery
  - gdcm::StringFilter, 1052
- Explicit
  - gdcm::TransferSyntax, 1134
- ExplicitVRBigEndian
  - gdcm::TransferSyntax, 1135
  - gdcm::UIDs, 1166
- ExplicitVRLittleEndian
  - gdcm::TransferSyntax, 1135
  - gdcm::UIDs, 1166
- Explore
  - gdcm::Directory, 387
- ExtensibleSRStorage
  - gdcm::UIDs, 1174
- Extract
  - gdcm::IconImageFilter, 519
- ExtractIconImages
  - gdcm::IconImageFilter, 519
- ExtractVeprolIconImages
  - gdcm::IconImageFilter, 519
- F
  - gdcm::Printer, 868
  - gdcm::Reader, 909
  - gdcm::Validate, 1269
  - gdcm::XMLPrinter, 1430
- FACET
  - gdcm::MeshPrimitive, 695
- FallColorPaletteSOPInstance
  - gdcm::UIDs, 1172
- FD
  - gdcm::VR, 1288
- Fiducials
  - gdcm::Fiducials, 447
- File
  - gdcm::File, 449
- FileAnonymizer
  - gdcm::FileAnonymizer, 454
- FileChangeTransferSyntax
  - gdcm::FileChangeTransferSyntax, 458
  - gdcm::ImageCodec, 560
- FileDecompressLookupTable
  - gdcm::FileDecompressLookupTable, 461
- FileDerivation
  - gdcm::FileDerivation, 464
- FileExists
  - gdcm::System, 1090
- FileExplicitFilter
  - gdcm::FileExplicitFilter, 468
- FilesDirectory
  - gdcm::System, 1090
- FilesSymlink
  - gdcm::System, 1090
- FileList
  - gdcm, 58
- FileMetaInformation
  - gdcm::FileMetaInformation, 472, 473
- FileName
  - vtkGDCMPolyDataReader, 1345
- Filename
  - gdcm::Filename, 480
- filename
  - gdcm::FileWithName, 500
- FileNameEvent
  - gdcm::FileNameEvent, 485
- FilenameGenerator
  - gdcm::FilenameGenerator, 488
- FileNameOrdering
  - gdcm::SerieHelper, 977
- FileNames
  - vtkGDCMImageReader, 1310
- Filenames
  - gdcm::Sorter, 1015
- FilenamesType
  - gdcm::DICOMDIRGenerator, 356
  - gdcm::Directory, 387
  - gdcm::FilenameGenerator, 488
- FilenameType
  - gdcm::DICOMDIRGenerator, 356
  - gdcm::Directory, 387
  - gdcm::FilenameGenerator, 488
- FileSet
  - gdcm::FileSet, 492
- FileSize
  - gdcm::System, 1091
- FileStreamer
  - gdcm::FileStreamer, 495
- FileType
  - gdcm::FileSet, 491
- FileTime
  - gdcm::System, 1091
- FileType
  - gdcm::FileSet, 492
- FileWithName
  - gdcm::FileWithName, 500
- Fill
  - gdcm::ByteValue, 226
- FillFromDataSet
  - gdcm::FileMetaInformation, 474
- FillMedicalImageInformation
  - vtkGDCMImageReader, 1302
  - vtkGDCMImageReader2, 1316
  - vtkGDCMPolyDataReader, 1342
- FindContext
  - gdcm::network::ULConnection, 1231

- FindCSAElementByName
  - gdcm::CSAHeader, 289
- FindDataElement
  - gdcm::DataSet, 332
  - gdcm::Item, 613
  - gdcm::SequenceOfItems, 969
- FindDictEntry
  - gdcm::PrivateDict, 869
- FindMacroEntry
  - gdcm::Macro, 669
- FindModuleEntryInMacros
  - gdcm::Module, 707
- FindMrProtocolByName
  - gdcm::MrProtocol, 722
- FindNextDataElement
  - gdcm::DataSet, 332
- FindPatientRootQuery
  - gdcm::FindPatientRootQuery, 502
- FindPDBelementByName
  - gdcm::PDBHeader, 793
- FindStudyRootQuery
  - gdcm::FindStudyRootQuery, 505
- FirstRender
  - vtkImageColorViewer, 1380
- FL
  - gdcm::VR, 1288
- FLOAT16
  - gdcm::PixelFormat, 812
- FLOAT32
  - gdcm::PixelFormat, 812
- FLOAT64
  - gdcm::PixelFormat, 812
- ForceRescale
  - vtkGDCMImageReader, 1311
  - vtkGDCMImageReader2, 1325
- FormatDateTime
  - gdcm::System, 1091
- Fragment
  - gdcm::Fragment, 508
- FragmentVector
  - gdcm::SequenceOfFragments, 959
- FromString
  - gdcm::StringFilter, 1052
- FUJIFilm
  - gdcm::EquipmentManufacturer, 433
- FujiPrivateCRImageStorage
  - gdcm::MediaStorage, 681
- FujiPrivateMammoCRImageStorage
  - gdcm::MediaStorage, 681
- gdcm, 43
  - add1, 63
  - AECComp, 58
  - ASComp, 58
  - backslash, 63
  - BOOL\_FUNCTION\_PFILE\_PFILE\_POINTER, 58
  - Clamp, 63
  - clean, 63
  - CompOperators, 60
  - CSComp, 58
  - DAComp, 58
  - doround, 64
  - DTComp, 58
  - eArabic, 61
  - ECharSet, 61
  - eCreateMMPS, 62
  - eCyrillic, 61
  - eFind, 62
  - eGB18030, 61
  - eGreek, 61
  - eHebrew, 61
  - eImage, 62
  - eJapanese, 61
  - eJapaneseKanjiMultibyte, 61
  - eJapaneseSupplementaryKanjiMultibyte, 61
  - eKoreanHangulHanjaMultibyte, 61
  - eLatin1, 61
  - eLatin2, 61
  - eLatin3, 61
  - eLatin4, 61
  - eLatin5, 61
  - eMove, 62
  - ENQueryType, 61
  - ePatient, 62
  - ePatientRootType, 62
  - EQueryLevel, 62
  - EQueryType, 62
  - ERootType, 62
  - eSeries, 62
  - eSetMMPS, 62
  - eStudy, 62
  - eStudyRootType, 62
  - eThai, 61
  - eUTF8, 61
  - eWLMFind, 62
  - FileList, 58
  - GDCM\_DIFFERENT, 61
  - GDCM\_EQUAL, 61
  - GDCM\_GREATER, 61
  - GDCM\_GREATEROREQUAL, 61
  - GDCM\_LESS, 61
  - GDCM\_LESSOREQUAL, 61
  - GetVRFromTag, 64
  - GlobalInstance, 76
  - IconImage, 59
  - LD\_ALL, 63
  - LD\_NOSEQ, 63
  - LD\_NOSHADOW, 63



- LD\_NOSHADOWSEQ, [63](#)
- LOComp, [59](#)
- LodModeType, [62](#)
- LTCComp, [59](#)
- MacroEntry, [59](#)
- NestedMacroEntries, [59](#)
- operator!=, [64](#)
- operator<<, [64–74](#)
- operator>>, [74, 75](#)
- operator==, [74](#)
- PNComp, [59](#)
- Round, [75](#)
- roundat, [75](#)
- SHComp, [59](#)
- STComp, [60](#)
- TMComp, [60](#)
- TYPETOENCODING, [75](#)
- UCComp, [60](#)
- UIComp, [60](#)
- URComp, [60](#)
- UTCComp, [60](#)
- VRBINARY, [76](#)
- x16printf, [76](#)
- gdcmm::AbortEvent, [103](#)
- gdcmm::AnonymizeEvent, [107](#)
  - ~AnonymizeEvent, [109](#)
  - AnonymizeEvent, [108, 109](#)
  - CheckEvent, [109](#)
  - GetEventName, [109](#)
  - GetTag, [109](#)
  - MakeObject, [109](#)
  - operator=, [110](#)
  - Self, [108](#)
  - SetTag, [110](#)
  - Superclass, [108](#)
- gdcmm::Anonymizer, [110](#)
  - ~Anonymizer, [113](#)
  - Anonymizer, [113](#)
  - BALCPPProtect, [113](#)
  - BasicApplicationLevelConfidentialityProfile, [113](#)
  - CanEmptyTag, [114](#)
  - ClearInternalUIDs, [114](#)
  - Empty, [114](#)
  - GetBasicApplicationLevelConfidentialityProfileAttributes, [114](#)
  - GetCryptographicMessageSyntax, [115](#)
  - GetFile, [115](#)
  - New, [115](#)
  - RecurseDataSet, [115](#)
  - Remove, [115](#)
  - RemoveGroupLength, [115](#)
  - RemovePrivateTags, [116](#)
  - RemoveRetired, [116](#)
  - Replace, [116](#)
  - SetCryptographicMessageSyntax, [117](#)
  - SetFile, [117](#)
- gdcmm::AnyEvent, [118](#)
- gdcmm::ApplicationEntity, [121](#)
  - Internal, [123](#)
  - IsValid, [122](#)
  - MaxLength, [123](#)
  - MaxNumberOfComponents, [123](#)
  - Padding, [123](#)
  - Print, [122](#)
  - Separator, [123](#)
  - SetBlob, [122](#)
  - Squeeze, [123](#)
- gdcmm::ASN1, [130](#)
  - ~ASN1, [131](#)
  - ASN1, [131](#)
  - operator=, [132](#)
  - ParseDump, [132](#)
  - ParseDumpFile, [132](#)
  - TestPBKDF2, [132](#)
- gdcmm::Attribute< Group, Element, TVR, TVM >, [134](#)
  - ArrayType, [136](#)
  - GDCM\_STATIC\_ASSERT, [137](#)
  - GetAsDataElement, [137](#)
  - GetDictVM, [137](#)
  - GetDictVR, [138](#)
  - GetNumberOfValues, [138](#)
  - GetTag, [138](#)
  - GetValue, [138, 139](#)
  - GetValues, [139](#)
  - GetVM, [139](#)
  - GetVR, [139](#)
  - Internal, [143](#)
  - operator!=, [140](#)
  - operator<, [140](#)
  - operator==, [140](#)
  - operator[], [140](#)
  - Print, [141](#)
  - Set, [141](#)
  - SetByteValue, [141](#)
  - SetByteValueNoSwap, [141](#)
  - SetFromDataElement, [142](#)
  - SetFromDataSet, [142](#)
  - SetValue, [142](#)
  - SetValues, [143](#)
  - VMType, [137](#)
- gdcmm::Attribute< Group, Element, TVR, VM::VM1 >, [144](#)
  - ArrayType, [145](#)
  - GDCM\_STATIC\_ASSERT, [146](#)
  - GetAsDataElement, [146](#)
  - GetDictVM, [147](#)
  - GetDictVR, [147](#)
  - GetNumberOfValues, [147](#)
  - GetTag, [147](#)



- GetValue, [147](#)
- GetValues, [148](#)
- GetVM, [148](#)
- GetVR, [148](#)
- Internal, [150](#)
- operator!=, [148](#)
- operator<, [148](#)
- operator==, [148](#)
- Print, [149](#)
- Set, [149](#)
- SetByteValue, [149](#)
- SetByteValueNoSwap, [149](#)
- SetFromDataElement, [149](#)
- SetFromDataSet, [150](#)
- SetValue, [150](#)
- VMType, [146](#)
- gdcM::Attribute< Group, Element, TVR, VM::VM1\_3 >, [151](#)
  - GetVM, [151](#)
- gdcM::Attribute< Group, Element, TVR, VM::VM1\_8 >, [152](#)
  - GetVM, [153](#)
- gdcM::Attribute< Group, Element, TVR, VM::VM1\_n >, [153](#)
  - ~Attribute, [155](#)
  - ArrayType, [154](#)
  - Attribute, [155](#)
  - GDCM\_STATIC\_ASSERT, [155](#)
  - GetAsDataElement, [155](#)
  - GetDictVM, [156](#)
  - GetDictVR, [156](#)
  - GetNumberOfValues, [156](#)
  - GetTag, [156](#)
  - GetValue, [156](#)
  - GetValues, [157](#)
  - GetVM, [157](#)
  - GetVR, [157](#)
  - operator[], [157](#)
  - Print, [157](#)
  - Set, [158](#)
  - SetByteValue, [158](#)
  - SetFromDataElement, [158](#)
  - SetFromDataSet, [158](#)
  - SetNumberOfValues, [158](#)
  - SetValue, [159](#)
  - SetValues, [159](#)
- gdcM::Attribute< Group, Element, TVR, VM::VM2\_2n >, [160](#)
  - GetVM, [161](#)
- gdcM::Attribute< Group, Element, TVR, VM::VM2\_n >, [161](#)
  - GetVM, [162](#)
- gdcM::Attribute< Group, Element, TVR, VM::VM3\_3n >, [163](#)
  - GetVM, [164](#)
- gdcM::Attribute< Group, Element, TVR, VM::VM3\_n >, [164](#)
  - GetVM, [165](#)
- gdcM::AudioCodec, [166](#)
  - ~AudioCodec, [167](#)
  - AudioCodec, [167](#)
  - CanCode, [167](#)
  - CanDecode, [167](#)
  - Decode, [168](#)
- gdcM::Base64, [168](#)
  - Base64, [169](#)
  - Decode, [169](#)
  - Encode, [169](#)
  - GetDecodeLength, [170](#)
  - GetEncodeLength, [170](#)
  - operator=, [170](#)
- gdcM::BaseQuery, [177](#)
  - ~BaseQuery, [179](#)
  - AddQueryDataSet, [179](#)
  - BaseQuery, [179](#)
  - GetAbstractSyntaxUID, [180](#)
  - GetQueryDataSet, [180](#)
  - GetSOPInstanceUID, [180](#)
  - mDataSet, [182](#)
  - mSopInstanceUID, [182](#)
  - Print, [180](#)
  - QueryFactory, [182](#)
  - SetSearchParameter, [180](#), [181](#)
  - SetSOPInstanceUID, [181](#)
  - ValidateQuery, [181](#)
  - ValidDataSet, [181](#)
  - WriteHelpFile, [182](#)
  - WriteQuery, [182](#)
- gdcM::BaseRootQuery, [183](#)
  - ~BaseRootQuery, [185](#)
  - BaseRootQuery, [185](#)
  - Construct, [185](#)
  - GetQueryLevelFromQueryRoot, [185](#)
  - GetQueryLevelFromString, [185](#)
  - GetQueryLevelString, [185](#)
  - GetTagListByLevel, [186](#)
  - InitializeDataSet, [186](#)
  - mHelpDescription, [187](#)
  - mImage, [187](#)
  - mPatient, [187](#)
  - mRootType, [187](#)
  - mSeries, [187](#)
  - mStudy, [187](#)
  - QueryFactory, [187](#)
  - ValidateQuery, [186](#)
- gdcM::BasicOffsetTable, [191](#)
  - BasicOffsetTable, [192](#)
  - operator<<, [193](#)

- Read, [193](#)
- gdcM::Bitmap, [194](#)
  - ~Bitmap, [197](#)
  - AreOverlaysInPixelData, [197](#)
  - Bitmap, [197](#)
  - Clear, [197](#)
  - ComputeLossyFlag, [197](#)
  - Dimensions, [208](#)
  - GetBuffer, [198](#)
  - GetBuffer2, [198](#)
  - GetBufferLength, [198](#)
  - GetColumns, [198](#)
  - GetDataElement, [198](#), [199](#)
  - GetDimension, [199](#)
  - GetDimensions, [199](#)
  - GetLUT, [199](#)
  - GetNeedByteSwap, [200](#)
  - GetNumberOfDimensions, [200](#)
  - GetPhotometricInterpretation, [200](#)
  - GetPixelFormat, [200](#), [201](#)
  - GetPlanarConfiguration, [201](#)
  - GetRows, [201](#)
  - GetTransferSyntax, [201](#)
  - ImageChangeTransferSyntax, [207](#)
  - IsEmpty, [201](#)
  - IsLossy, [202](#)
  - IsTransferSyntaxCompatible, [202](#)
  - LossyFlag, [208](#)
  - LUT, [208](#)
  - LUTPtr, [197](#)
  - NeedByteSwap, [208](#)
  - NumberOfDimensions, [208](#)
  - PF, [208](#)
  - PI, [208](#)
  - PixelData, [209](#)
  - PixmapReader, [207](#)
  - PlanarConfiguration, [209](#)
  - Print, [202](#)
  - SetColumns, [202](#)
  - SetDataElement, [202](#)
  - SetDimension, [203](#)
  - SetDimensions, [203](#)
  - SetLossyFlag, [203](#)
  - SetLUT, [203](#)
  - SetNeedByteSwap, [204](#)
  - SetNumberOfDimensions, [204](#)
  - SetPhotometricInterpretation, [204](#)
  - SetPixelFormat, [204](#)
  - SetPlanarConfiguration, [205](#)
  - SetRows, [205](#)
  - SetTransferSyntax, [205](#)
  - TryJPEG2000Codec, [205](#)
  - TryJPEG2000Codec2, [206](#)
  - TryJPEGCodec, [206](#)
  - TryJPEGCodec2, [206](#)
  - TryJPEGLSCodec, [206](#)
  - TryKAKADUCodec, [206](#)
  - TryPVRGCodec, [206](#)
  - TryRAWCodec, [207](#)
  - TryRLECodec, [207](#)
  - TS, [209](#)
  - UnusedBitsPresentInPixelData, [207](#)
- gdcM::BitmapToBitmapFilter, [209](#)
  - ~BitmapToBitmapFilter, [211](#)
  - BitmapToBitmapFilter, [211](#)
  - GetOutput, [211](#)
  - GetOutputAsBitmap, [211](#)
  - Input, [212](#)
  - Output, [212](#)
  - SetInput, [211](#)
- gdcM::BoxRegion, [212](#)
  - ~BoxRegion, [214](#)
  - Area, [214](#)
  - BoundingBox, [214](#)
  - BoxRegion, [214](#)
  - Clone, [215](#)
  - ComputeBoundingBox, [215](#)
  - Empty, [215](#)
  - GetXMax, [215](#)
  - GetXMin, [215](#)
  - GetYMax, [216](#)
  - GetYMin, [216](#)
  - GetZMax, [216](#)
  - GetZMin, [216](#)
  - IsValid, [216](#)
  - operator=, [216](#)
  - Print, [217](#)
  - SetDomain, [217](#)
- gdcM::ByteBuffer, [217](#)
  - ByteBuffer, [218](#)
  - Get, [218](#)
  - GetStart, [218](#)
  - ShiftEnd, [218](#)
  - UpdatePosition, [218](#)
- gdcM::ByteSwap< T >, [219](#)
  - Swap, [219](#)
  - SwapFromSwapCodeIntoSystem, [220](#)
  - SwapRange, [220](#)
  - SwapRangeFromSwapCodeIntoSystem, [220](#)
  - SystemIsBigEndian, [220](#)
  - SystemIsLittleEndian, [221](#)
- gdcM::ByteSwapFilter, [221](#)
  - ~ByteSwapFilter, [222](#)
  - ByteSwap, [222](#)
  - ByteSwapFilter, [221](#), [222](#)
  - operator=, [222](#)
  - SetByteSwapTag, [222](#)
- gdcM::ByteValue, [223](#)

- ~ByteValue, [225](#)
- Append, [226](#)
- ByteValue, [225](#)
- Clear, [226](#)
- ComputeLength, [226](#)
- Fill, [226](#)
- GetBuffer, [226](#)
- GetLength, [226](#)
- GetPointer, [227](#)
- GetVoidPointer, [227](#)
- IsEmpty, [228](#)
- IsPrintable, [228](#)
- operator const std::vector< char > &, [228](#)
- operator=, [228](#)
- operator==, [228](#), [229](#)
- Print, [229](#)
- PrintASCII, [229](#)
- PrintASCIIXML, [229](#)
- PrintGroupLength, [229](#)
- PrintHex, [229](#)
- PrintHexXML, [230](#)
- PrintPNXML, [230](#)
- Read, [230](#)
- SetLength, [230](#)
- SetLengthOnly, [230](#)
- Write, [231](#)
- WriteBuffer, [231](#)
- gdc::CAPICryptoFactory, [232](#)
  - CAPICryptoFactory, [232](#)
  - CreateCMSProvider, [233](#)
- gdc::CAPICryptographicMessageSyntax, [233](#)
  - ~CAPICryptographicMessageSyntax, [234](#)
  - CAPICryptographicMessageSyntax, [234](#)
  - Decrypt, [235](#)
  - Encrypt, [235](#)
  - GetCipherType, [235](#)
  - GetInitialized, [235](#)
  - ParseCertificateFile, [236](#)
  - ParseKeyFile, [236](#)
  - SetCipherType, [236](#)
  - SetPassword, [236](#)
- gdc::Codec, [249](#)
- gdc::Coder, [250](#)
  - ~Coder, [250](#)
  - CanCode, [251](#)
  - Code, [251](#)
  - InternalCode, [251](#)
- gdc::CodeString, [252](#)
  - CodeString, [254](#), [255](#)
  - const\_iterator, [253](#)
  - const\_reference, [253](#)
  - const\_reverse\_iterator, [253](#)
  - difference\_type, [253](#)
  - GetAsString, [255](#)
  - IsValid, [255](#)
  - iterator, [253](#)
  - operator!=, [256](#)
  - operator<<, [256](#)
  - operator==, [256](#)
  - pointer, [254](#)
  - reference, [254](#)
  - reverse\_iterator, [254](#)
  - Size, [256](#)
  - size\_type, [254](#)
  - TrimInternal, [256](#)
  - value\_type, [254](#)
- gdc::Command, [257](#)
  - ~Command, [259](#)
  - Command, [258](#), [259](#)
  - Execute, [259](#)
  - operator=, [259](#)
- gdc::CommandDataSet, [260](#)
  - ~CommandDataSet, [261](#)
  - CommandDataSet, [261](#)
  - Insert, [261](#)
  - operator<<, [262](#)
  - Read, [262](#)
  - Replace, [262](#)
  - Write, [262](#)
- gdc::CompositeNetworkFunctions, [264](#)
  - CEcho, [266](#)
  - CFind, [266](#)
  - CMove, [267](#)
  - ConstructQuery, [267](#), [268](#)
  - CStore, [268](#)
  - KeyValuePairArrayType, [265](#)
  - KeyValuePairType, [265](#)
- gdc::ConstCharWrapper, [269](#)
  - ConstCharWrapper, [269](#)
  - operator const char \*, [269](#)
- gdc::CP246ExplicitDataElement, [270](#)
  - GetLength, [271](#)
  - Read, [271](#)
  - ReadPreValue, [271](#)
  - ReadValue, [271](#)
  - ReadWithLength, [272](#)
- gdc::CryptoFactory, [272](#)
  - ~CryptoFactory, [274](#)
  - CAPI, [273](#)
  - CreateCMSProvider, [274](#)
  - CryptoFactory, [274](#)
  - CryptoLib, [273](#)
  - DEFAULT, [273](#)
  - GetFactoryInstance, [274](#)
  - OPENSSL, [273](#)
  - OPENSSL7, [273](#)
- gdc::CryptographicMessageSyntax, [275](#)
  - ~CryptographicMessageSyntax, [276](#)

- AES128\_CIPHER, [276](#)
- AES192\_CIPHER, [276](#)
- AES256\_CIPHER, [276](#)
- CipherTypes, [275](#)
- CryptographicMessageSyntax, [276](#)
- Decrypt, [276](#)
- DES3\_CIPHER, [276](#)
- Encrypt, [276](#)
- GetCipherType, [277](#)
- operator=, [277](#)
- ParseCertificateFile, [277](#)
- ParseKeyFile, [277](#)
- SetCipherType, [277](#)
- SetPassword, [278](#)
- gdcM::CSAElement, [278](#)
  - CSAElement, [280](#)
  - DataField, [285](#)
  - DataPtr, [280](#)
  - GetByteValue, [281](#)
  - GetKey, [281](#)
  - GetName, [281](#)
  - GetNoOfItems, [281](#)
  - GetSyngoDT, [281](#)
  - GetValue, [282](#)
  - GetVM, [282](#)
  - GetVR, [282](#)
  - IsEmpty, [282](#)
  - KeyField, [285](#)
  - NameField, [285](#)
  - NoOfItemsField, [285](#)
  - operator<, [283](#)
  - operator<<, [285](#)
  - operator=, [283](#)
  - operator==, [283](#)
  - SetByteValue, [283](#)
  - SetKey, [283](#)
  - SetName, [284](#)
  - SetNoOfItems, [284](#)
  - SetSyngoDT, [284](#)
  - SetValue, [284](#)
  - SetVM, [284](#)
  - SetVR, [284](#)
  - SyngoDTField, [286](#)
  - ValueMultiplicityField, [286](#)
  - VRField, [286](#)
- gdcM::CSAHeader, [286](#)
  - ~CSAHeader, [289](#)
  - CSAHeader, [288](#)
  - CSAHeaderType, [288](#)
  - DATASET\_FORMAT, [288](#)
  - FindCSAElementByName, [289](#)
  - GetCSADatInfo, [289](#)
  - GetCSAEEnd, [289](#)
  - GetCSAElementByName, [289](#)
  - GetCSAImageHeaderInfoTag, [290](#)
  - GetCSASeriesHeaderInfoTag, [290](#)
  - GetDataSet, [290](#)
  - GetFormat, [291](#)
  - GetInterfile, [291](#)
  - GetMrProtocol, [291](#)
  - INTERFILE, [288](#)
  - LoadFromDataElement, [291](#)
  - NOMAGIC, [288](#)
  - operator<<, [292](#)
  - Print, [291](#)
  - SV10, [288](#)
  - UNKNOWN, [288](#)
  - ZEROED\_OUT, [288](#)
- gdcM::CSAHeaderDict, [292](#)
  - AddCSAHeaderDictEntry, [294](#)
  - Begin, [294](#)
  - ConstIterator, [293](#)
  - CSAHeaderDict, [293](#), [294](#)
  - Dicts, [295](#)
  - End, [294](#)
  - GetCSAHeaderDictEntry, [294](#)
  - IsEmpty, [294](#)
  - Iterator, [293](#)
  - LoadDefault, [295](#)
  - MapCSAHeaderDictEntry, [293](#)
  - operator<<, [295](#)
  - operator=, [295](#)
- gdcM::CSAHeaderDictEntry, [295](#)
  - CSAHeaderDictEntry, [296](#)
  - GetDescription, [297](#)
  - GetName, [297](#)
  - GetVM, [297](#)
  - GetVR, [297](#)
  - operator<, [297](#)
  - operator<<, [298](#)
  - SetDescription, [298](#)
  - SetName, [298](#)
  - SetVM, [298](#)
  - SetVR, [298](#)
- gdcM::CSAHeaderDictException, [299](#)
- gdcM::Curve, [303](#)
  - ~Curve, [305](#)
  - Curve, [304](#), [305](#)
  - Decode, [305](#)
  - GetAsPoints, [305](#)
  - GetCurveDataDescriptor, [305](#)
  - GetDataValueRepresentation, [305](#)
  - GetDimensions, [306](#)
  - GetGroup, [306](#)
  - GetNumberOfCurves, [306](#)
  - GetNumberOfPoints, [306](#)
  - GetTypeOfData, [306](#)
  - GetTypeOfDataDescription, [306](#)

- IsEmpty, 306
- Print, 307
- SetCoordinateStartValue, 307
- SetCoordinateStepValue, 307
- SetCurve, 307
- SetCurveDataDescriptor, 307
- SetCurveDescription, 307
- SetDataValueRepresentation, 308
- SetDimensions, 308
- SetGroup, 308
- SetNumberOfPoints, 308
- SetTypeOfData, 308
- Update, 308
- gdcmm::DataElement, 309
  - Clear, 313
  - DataElement, 312, 313
  - Empty, 313
  - GetByteValue, 313
  - GetLength, 313
  - GetSequenceOfFragments, 314
  - GetTag, 314
  - GetValue, 314, 315
  - GetValueAsSQ, 315
  - GetVL, 315, 316
  - GetVR, 316
  - IsEmpty, 316
  - IsUndefinedLength, 316
  - operator<, 317
  - operator<<, 321
  - operator=, 317
  - operator==, 317
  - Read, 317
  - ReadOrSkip, 317
  - ReadPreValue, 318
  - ReadValue, 318
  - ReadValueWithLength, 318
  - ReadWithLength, 318
  - SetByteValue, 318
  - SetTag, 319
  - SetValue, 319
  - SetValueFieldLength, 320
  - SetVL, 320
  - SetVLToUndefined, 320
  - SetVR, 320
  - TagField, 321
  - ValueField, 322
  - ValueLengthField, 322
  - ValuePtr, 312
  - VRField, 322
  - Write, 321
- gdcmm::DataElementException, 323
- gdcmm::DataEvent, 323
  - ~DataEvent, 325
  - CheckEvent, 326
  - DataEvent, 325, 326
  - GetData, 326
  - GetDataLength, 326
  - GetEventName, 326
  - MakeObject, 326
  - operator=, 327
  - Self, 325
  - SetData, 327
  - Superclass, 325
- gdcmm::DataSet, 327
  - Begin, 331
  - Clear, 331
  - ComputeDataElement, 331
  - ComputeGroupLength, 331
  - ConstIterator, 330
  - CSAHeader, 339
  - DataElementSet, 330
  - End, 331, 332
  - FindDataElement, 332
  - FindNextDataElement, 332
  - GetDataElement, 333
  - GetDEEnd, 333
  - GetDES, 334
  - GetLength, 334
  - GetMediaStorage, 334
  - GetPrivateCreator, 334
  - Insert, 334
  - InsertDataElement, 335
  - IsEmpty, 335
  - Iterator, 330
  - operator<<, 339
  - operator(), 335
  - operator=, 335
  - operator[], 336
  - Print, 336
  - Read, 336
  - ReadNested, 336
  - ReadSelectedPrivateTags, 336
  - ReadSelectedPrivateTagsWithLength, 337
  - ReadSelectedTags, 337
  - ReadSelectedTagsWithLength, 337
  - ReadUpToTag, 337
  - ReadUpToTagWithLength, 337
  - ReadWithLength, 338
  - Remove, 338
  - Replace, 338
  - ReplaceEmpty, 338
  - Size, 339
  - SizeType, 330
  - Write, 339
- gdcmm::DataSetEvent, 340
  - ~DataSetEvent, 342
  - CheckEvent, 342
  - DataSetEvent, 342

- GetDataSet, [343](#)
- GetEventName, [343](#)
- m\_DataSet, [343](#)
- MakeObject, [343](#)
- operator=, [343](#)
- Self, [342](#)
- Superclass, [342](#)
- gdcM::DataSetHelper, [344](#)
  - ComputeVR, [344](#)
- gdcM::Decoder, [345](#)
  - ~Decoder, [345](#)
  - CanDecode, [346](#)
  - Decode, [346](#)
  - DecodeByStreams, [346](#)
- gdcM::DefinedTerms, [347](#)
  - DefinedTerms, [347](#)
- gdcM::Defs, [347](#)
  - ~Defs, [349](#)
  - Defs, [348](#), [349](#)
  - GetIODFromFile, [349](#)
  - GetIODNameFromMediaStorage, [349](#)
  - GetIODs, [349](#)
  - GetMacros, [350](#)
  - GetModules, [350](#)
  - GetTypeFromTag, [350](#)
  - Global, [351](#)
  - IsEmpty, [350](#)
  - LoadDefaults, [350](#)
  - LoadFromFile, [351](#)
  - operator=, [351](#)
  - Verify, [351](#)
- gdcM::DeltaEncodingCodec, [352](#)
  - ~DeltaEncodingCodec, [353](#)
  - CanDecode, [353](#)
  - Decode, [353](#)
  - DeltaEncodingCodec, [353](#)
- gdcM::DICOMDIR, [354](#)
  - DICOMDIR, [354](#)
- gdcM::DICOMDIRGenerator, [355](#)
  - ~DICOMDIRGenerator, [356](#)
  - AddImageDirectoryRecord, [357](#)
  - AddPatientDirectoryRecord, [357](#)
  - AddSeriesDirectoryRecord, [357](#)
  - AddStudyDirectoryRecord, [357](#)
  - DICOMDIRGenerator, [356](#)
  - FileNamesType, [356](#)
  - FilenameType, [356](#)
  - Generate, [357](#)
  - GetFile, [357](#)
  - GetScanner, [358](#)
  - SetDescriptor, [358](#)
  - SetFile, [358](#)
  - SetFileNames, [358](#)
  - SetRootDirectory, [358](#)
- gdcM::Dict, [359](#)
  - AddDictEntry, [361](#)
  - Begin, [361](#)
  - ConstIterator, [360](#)
  - Dict, [360](#), [361](#)
  - Dicts, [363](#)
  - End, [361](#)
  - GetDictEntry, [361](#)
  - GetDictEntryByKeyword, [362](#)
  - GetDictEntryByName, [362](#)
  - GetKeywordFromTag, [362](#)
  - IsEmpty, [362](#)
  - Iterator, [360](#)
  - LoadDefault, [363](#)
  - MapDictEntry, [360](#)
  - operator<<, [363](#)
  - operator=, [363](#)
- gdcM::DictConverter, [363](#)
  - ~DictConverter, [365](#)
  - AddGroupLength, [365](#)
  - Convert, [365](#)
  - ConvertToCXX, [366](#)
  - ConvertToXML, [366](#)
  - DICT\_DEBUG, [365](#)
  - DICT\_DEFAULT, [365](#)
  - DICT\_XML, [365](#)
  - DictConverter, [365](#)
  - GetDictName, [366](#)
  - GetInputFilename, [366](#)
  - GetOutputFilename, [366](#)
  - GetOutputType, [366](#)
  - OutputTypes, [365](#)
  - Readuint16, [366](#)
  - ReadVM, [367](#)
  - ReadVR, [367](#)
  - SetDictName, [367](#)
  - SetInputFileName, [367](#)
  - SetOutputFileName, [367](#)
  - SetOutputType, [367](#)
  - WriteFooter, [368](#)
  - WriteHeader, [368](#)
- gdcM::DictEntry, [368](#)
  - Dict, [372](#)
  - DictEntry, [369](#)
  - GetKeyword, [369](#)
  - GetName, [370](#)
  - GetRetired, [370](#)
  - GetVM, [370](#)
  - GetVR, [370](#)
  - IsUnique, [371](#)
  - operator<<, [372](#)
  - SetElementXX, [371](#)
  - SetGroupXX, [371](#)
  - SetKeyword, [371](#)

- SetName, [371](#)
- SetRetired, [372](#)
- SetVM, [372](#)
- SetVR, [372](#)
- gdcM::DictPrinter, [373](#)
  - ~DictPrinter, [375](#)
  - DictPrinter, [374](#)
  - Print, [375](#)
  - PrintDataElement2, [375](#)
  - PrintDataSet2, [375](#)
- gdcM::Dicts, [376](#)
  - ~Dicts, [377](#)
  - ConstructorType, [377](#)
  - Dicts, [377](#)
  - GEMS, [377](#)
  - GetConstructorString, [378](#)
  - GetCSAHeaderDict, [378](#)
  - GetDictEntry, [378](#)
  - GetPrivateDict, [378](#), [379](#)
  - GetPublicDict, [379](#)
  - Global, [379](#)
  - IsEmpty, [379](#)
  - LoadDefaults, [379](#)
  - operator<<, [380](#)
  - operator=, [379](#)
  - PHILIPS, [377](#)
  - SIEMENS, [377](#)
- gdcM::DirectionCosines, [382](#)
  - ~DirectionCosines, [383](#)
  - ComputeDistAlongNormal, [383](#)
  - Cross, [383](#)
  - CrossDot, [383](#)
  - DirectionCosines, [383](#)
  - Dot, [384](#)
  - IsValid, [384](#)
  - Normalize, [384](#)
  - operator const double \*, [385](#)
  - Print, [385](#)
  - SetFromString, [385](#)
- gdcM::Directory, [385](#)
  - ~Directory, [387](#)
  - Directory, [387](#)
  - Explore, [387](#)
  - FileNamesType, [387](#)
  - FilenameType, [387](#)
  - GetDirectories, [388](#)
  - GetFileNames, [388](#)
  - GetToplevel, [388](#)
  - Load, [388](#)
  - operator<<, [389](#)
  - Print, [389](#)
- gdcM::DirectoryHelper, [390](#)
  - GetCTImageSeriesUIDs, [390](#)
  - GetFileNamesFromSeriesUIDs, [390](#)
- GetFrameOfReference, [391](#)
- GetMRIImageSeriesUIDs, [391](#)
- GetRTStructSeriesUIDs, [391](#)
- GetSeriesUIDsBySOPClassUID, [391](#)
- GetSOPClassUID, [391](#)
- GetStringValueFromTag, [392](#)
- LoadImageFromFiles, [392](#)
- RetrieveSOPInstanceUIDFromIndex, [392](#)
- RetrieveSOPInstanceUIDFromZPosition, [392](#)
- gdcM::DummyValueGenerator, [392](#)
  - Generate, [393](#)
- gdcM::Dumper, [393](#)
  - ~Dumper, [395](#)
  - Dumper, [394](#)
- gdcM::Element< TVR, TVM >, [395](#)
  - GetAsDataElement, [397](#)
  - GetLength, [397](#)
  - GetValue, [398](#)
  - GetValues, [398](#)
  - GetVM, [398](#)
  - GetVR, [398](#)
  - Internal, [400](#)
  - operator[], [399](#)
  - Print, [399](#)
  - Read, [399](#)
  - Set, [399](#)
  - SetFromDataElement, [399](#)
  - SetNoSwap, [400](#)
  - SetValue, [400](#)
  - Type, [397](#)
  - Write, [400](#)
- gdcM::Element< TVR, VM::VM1\_2 >, [401](#)
  - Parent, [402](#)
  - SetLength, [402](#)
- gdcM::Element< TVR, VM::VM1\_n >, [403](#)
  - ~Element, [404](#)
  - Element, [404](#)
  - GetAsDataElement, [405](#)
  - GetLength, [405](#)
  - GetValue, [405](#)
  - GetVM, [405](#)
  - GetVR, [405](#)
  - operator=, [406](#)
  - operator[], [406](#)
  - Print, [406](#)
  - Read, [406](#)
  - Set, [406](#)
  - SetArray, [406](#)
  - SetFromDataElement, [407](#)
  - SetLength, [407](#)
  - SetNoSwap, [407](#)
  - SetValue, [407](#)
  - Type, [404](#)
  - Write, [407](#)

- WriteASCII, 408
- gdcM::Element< TVR, VM::VM2\_2n >, 408
  - Parent, 409
  - SetLength, 409
- gdcM::Element< TVR, VM::VM2\_n >, 410
  - Parent, 411
  - SetLength, 411
- gdcM::Element< TVR, VM::VM3\_3n >, 412
  - Parent, 413
  - SetLength, 413
- gdcM::Element< TVR, VM::VM3\_4 >, 414
  - Parent, 415
  - SetLength, 415
- gdcM::Element< TVR, VM::VM3\_n >, 416
  - Parent, 417
  - SetLength, 417
- gdcM::Element< VR::AS, VM::VM5 >, 417
  - GetLength, 418
  - Internal, 418
  - Print, 418
- gdcM::Element< VR::OB, VM::VM1 >, 418
- gdcM::Element< VR::OW, VM::VM1 >, 420
- gdcM::ElementDisableCombinations< TVR, TVM >, 422
- gdcM::ElementDisableCombinations< VR::OB, VM::VM1\_n >, 423
- gdcM::ElementDisableCombinations< VR::OW, VM::VM1\_n >, 423
- gdcM::EmptyMaskGenerator, 423
  - ~EmptyMaskGenerator, 425
  - EmptyMaskGenerator, 425
  - Execute, 425
  - SetInputDirectory, 425
  - SetOutputDirectory, 426
  - SetSOPClassUIDMode, 426
  - SOPClassUIDMode, 425
  - UseGrayscaleSecondaryImageStorage, 425
  - UseOriginalSOPClassUID, 425
- gdcM::EncapsulatedDocument, 426
  - EncapsulatedDocument, 427
- gdcM::EncodingImplementation< T >, 427
- gdcM::EncodingImplementation< VR::VRASCII >, 428
  - Read, 428
  - ReadComputeLength, 428
  - ReadNoSwap, 428
  - Write, 429
- gdcM::EncodingImplementation< VR::VRBINARY >, 429
  - Read, 430
  - ReadComputeLength, 430
  - ReadNoSwap, 430
  - Write, 430
- gdcM::EndEvent, 431
- gdcM::EnumeratedValues, 432
  - EnumeratedValues, 432
- gdcM::EquipmentManufacturer, 432
- Compute, 434
- FUJI, 433
- GEMS, 433
- HITACHI, 433
- KODAK, 433
- MARCONI, 433
- PMS, 433
- SIEMENS, 433
- TOSHIBA, 433
- Type, 433
- UNKNOWN, 433
- gdcM::Event, 434
  - ~Event, 436
  - CheckEvent, 436
  - Event, 436
  - GetEventName, 436
  - MakeObject, 437
  - operator=, 437
  - Print, 437
- gdcM::Exception, 438
  - ~Exception, 439
  - Exception, 439
  - GetDescription, 439
  - what, 439
- gdcM::ExitEvent, 440
- gdcM::ExplicitDataElement, 441
  - GetLength, 443
  - Read, 443
  - ReadPreValue, 443
  - ReadValue, 443
  - ReadWithLength, 443
  - Write, 443
- gdcM::ExplicitImplicitDataElement, 444
  - GetLength, 446
  - Read, 446
  - ReadPreValue, 446
  - ReadValue, 446
  - ReadWithLength, 446
- gdcM::Fiducials, 447
  - Fiducials, 447
- gdcM::File, 447
  - ~File, 449
  - File, 449
  - GetDataSet, 450
  - GetHeader, 450
  - operator<<, 452
  - Read, 451
  - SetDataSet, 451
  - SetHeader, 451
  - Write, 451
- gdcM::FileAnonymizer, 452
  - ~FileAnonymizer, 454
  - Empty, 454
  - FileAnonymizer, 454



- Remove, [454](#)
- Replace, [455](#)
- SetInputFileName, [455](#)
- SetOutputFileName, [455](#)
- Write, [456](#)
- gdcM::FileChangeTransferSyntax, [456](#)
  - ~FileChangeTransferSyntax, [458](#)
  - Change, [458](#)
  - FileChangeTransferSyntax, [458](#)
  - GetCodec, [458](#)
  - New, [458](#)
  - SetInputFileName, [459](#)
  - SetOutputFileName, [459](#)
  - SetTransferSyntax, [459](#)
- gdcM::FileDecompressLookupTable, [460](#)
  - ~FileDecompressLookupTable, [461](#)
  - Change, [461](#)
  - FileDecompressLookupTable, [461](#)
  - GetFile, [462](#)
  - GetPixmap, [462](#)
  - SetFile, [462](#)
  - SetPixmap, [462](#)
- gdcM::FileDerivation, [463](#)
  - ~FileDerivation, [464](#)
  - AddDerivationDescription, [464](#)
  - AddPurposeOfReferenceCodeSequence, [464](#)
  - AddReference, [464](#)
  - AddSourceImageSequence, [464](#)
  - Derive, [465](#)
  - FileDerivation, [464](#)
  - GetFile, [465](#)
  - SetAppendDerivationHistory, [465](#)
  - SetDerivationCodeSequenceCodeValue, [465](#)
  - SetDerivationDescription, [466](#)
  - SetFile, [466](#)
  - SetPurposeOfReferenceCodeSequenceCodeValue, [466](#)
- gdcM::FileExplicitFilter, [467](#)
  - ~FileExplicitFilter, [468](#)
  - Change, [468](#)
  - ChangeFMI, [468](#)
  - FileExplicitFilter, [468](#)
  - GetFile, [468](#)
  - ProcessDataSet, [468](#)
  - SetChangePrivateTags, [469](#)
  - SetFile, [469](#)
  - SetRecomputeItemLength, [469](#)
  - SetRecomputeSequenceLength, [469](#)
  - SetUseVRUN, [469](#)
- gdcM::FileMetaInformation, [470](#)
  - ~FileMetaInformation, [473](#)
  - AppendImplementationClassUID, [473](#)
  - ComputeDataSetMediaStorageSOPClass, [473](#)
  - ComputeDataSetTransferSyntax, [473](#)
  - DataSetMS, [479](#)
  - DataSetTS, [479](#)
  - Default, [473](#)
  - FileMetaInformation, [472, 473](#)
  - FillFromDataSet, [474](#)
  - GetDataSetTransferSyntax, [474](#)
  - GetFileMetaInformationVersion, [474](#)
  - GetFullLength, [474](#)
  - GetGDCMImplementationClassUID, [474](#)
  - GetGDCMImplementationVersionName, [474](#)
  - GetGDCMSourceApplicationEntityTitle, [475](#)
  - GetImplementationClassUID, [475](#)
  - GetImplementationVersionName, [475](#)
  - GetMediaStorage, [475](#)
  - GetMediaStorageAsString, [475](#)
  - GetMetaInformationTS, [475](#)
  - GetPreamble, [475, 476](#)
  - GetSourceApplicationEntityTitle, [476](#)
  - Insert, [476](#)
  - IsValid, [476](#)
  - MetaInformationTS, [479](#)
  - operator<<, [478](#)
  - operator=, [476](#)
  - Read, [476](#)
  - ReadCompat, [477](#)
  - ReadCompatInternal, [477](#)
  - Replace, [477](#)
  - SetDataSetTransferSyntax, [477](#)
  - SetImplementationClassUID, [477](#)
  - SetImplementationVersionName, [478](#)
  - SetPreamble, [478](#)
  - SetSourceApplicationEntityTitle, [478](#)
  - Write, [478](#)
- gdcM::Filename, [479](#)
  - EndWith, [481](#)
  - Filename, [480](#)
  - GetExtension, [481](#)
  - GetFileName, [481](#)
  - GetName, [481](#)
  - GetPath, [481](#)
  - IsEmpty, [481](#)
  - IsIdentical, [482](#)
  - Join, [482](#)
  - operator const char \*, [482](#)
  - ToUnixSlashes, [482](#)
  - ToWindowsSlashes, [482](#)
- gdcM::FileNameEvent, [483](#)
  - ~FileNameEvent, [485](#)
  - CheckEvent, [485](#)
  - FileNameEvent, [485](#)
  - GetEventName, [486](#)
  - GetFileName, [486](#)
  - MakeObject, [486](#)
  - operator=, [486](#)

- Self, [485](#)
- SetFileName, [486](#)
- Superclass, [485](#)
- gdcM::FilenameGenerator, [487](#)
  - ~FilenameGenerator, [489](#)
  - FilenameGenerator, [488](#)
  - FileNamesType, [488](#)
  - FilenameType, [488](#)
  - Generate, [489](#)
  - GetFilename, [489](#)
  - GetFileNames, [489](#)
  - GetNumberOfFileNames, [489](#)
  - GetPattern, [490](#)
  - GetPrefix, [490](#)
  - SetNumberOfFileNames, [490](#)
  - SetPattern, [490](#)
  - SetPrefix, [490](#)
  - SizeType, [488](#)
- gdcM::FileSet, [491](#)
  - AddFile, [492](#)
  - FileSet, [492](#)
  - FilesType, [491](#)
  - FileType, [492](#)
  - GetFiles, [492](#)
  - operator<<, [493](#)
  - SetFiles, [493](#)
- gdcM::FileStreamer, [493](#)
  - ~FileStreamer, [495](#)
  - AppendToDataElement, [495](#)
  - AppendToGroupDataElement, [495](#)
  - CheckDataElement, [496](#)
  - CheckTemplateFileName, [496](#)
  - FileStreamer, [495](#)
  - New, [496](#)
  - ReserveDataElement, [496](#)
  - ReserveGroupDataElement, [496](#)
  - SetOutputFileName, [497](#)
  - SetTemplateFileName, [497](#)
  - StartDataElement, [497](#)
  - StartGroupDataElement, [497](#)
  - StopDataElement, [498](#)
  - StopGroupDataElement, [498](#)
- gdcM::FileWithName, [498](#)
  - filename, [500](#)
  - FileWithName, [500](#)
- gdcM::FindPatientRootQuery, [501](#)
  - FindPatientRootQuery, [502](#)
  - GetAbstractSyntaxUID, [502](#)
  - GetTagListByLevel, [502](#)
  - InitializeDataSet, [502](#)
  - QueryFactory, [503](#)
  - ValidateQuery, [503](#)
- gdcM::FindStudyRootQuery, [504](#)
  - FindStudyRootQuery, [505](#)
  - GetAbstractSyntaxUID, [505](#)
  - GetTagListByLevel, [505](#)
  - InitializeDataSet, [505](#)
  - QueryFactory, [506](#)
  - ValidateQuery, [506](#)
- gdcM::Fragment, [507](#)
  - ComputeLength, [508](#)
  - Fragment, [508](#)
  - GetLength, [509](#)
  - operator<<, [510](#)
  - Read, [509](#)
  - ReadBacktrack, [509](#)
  - ReadPreValue, [509](#)
  - ReadValue, [509](#)
  - Write, [510](#)
- gdcM::Global, [510](#)
  - ~Global, [512](#)
  - Append, [512](#)
  - GetDefs, [512](#)
  - GetDicts, [512](#), [513](#)
  - GetInstance, [513](#)
  - Global, [511](#), [512](#)
  - LoadResourcesFiles, [513](#)
  - Locate, [513](#)
  - operator<<, [514](#)
  - operator=, [514](#)
  - Prepend, [514](#)
- gdcM::GroupDict, [514](#)
  - ~GroupDict, [516](#)
  - Add, [516](#)
  - GetAbbreviation, [516](#)
  - GetName, [516](#)
  - GroupDict, [515](#)
  - GroupStringVector, [515](#)
  - Insert, [516](#)
  - operator<<, [517](#)
  - Size, [516](#)
- gdcM::IconImageFilter, [517](#)
  - ~IconImageFilter, [518](#)
  - Extract, [519](#)
  - ExtractIconImages, [519](#)
  - ExtractVeprolIconImages, [519](#)
  - GetFile, [519](#)
  - GetIconImage, [519](#)
  - GetNumberOfIconImages, [520](#)
  - IconImageFilter, [518](#)
  - SetFile, [520](#)
- gdcM::IconImageGenerator, [520](#)
  - ~IconImageGenerator, [522](#)
  - AutoPixelMinMax, [522](#)
  - ConvertRGBToPaletteColor, [522](#)
  - Generate, [522](#)
  - GetIconImage, [522](#)
  - GetPixmap, [523](#)

- IconImageGenerator, [521](#)
- SetOutputDimensions, [523](#)
- SetOutsideValuePixel, [523](#)
- SetPixelMinMax, [523](#)
- SetPixmap, [524](#)
- gdcmm::ignore\_char, [524](#)
- ignore\_char, [524](#)
- m\_char, [525](#)
- gdcmm::Image, [525](#)
- ~Image, [527](#)
- GetDirectionCosines, [528](#)
- GetIntercept, [528](#)
- GetOrigin, [528](#)
- GetSlope, [529](#)
- GetSpacing, [529](#)
- Image, [527](#)
- Print, [529](#)
- SetDirectionCosines, [529](#), [530](#)
- SetIntercept, [530](#)
- SetOrigin, [530](#), [531](#)
- SetSlope, [531](#)
- SetSpacing, [531](#)
- gdcmm::ImageApplyLookupTable, [532](#)
- ~ImageApplyLookupTable, [534](#)
- Apply, [534](#)
- ImageApplyLookupTable, [534](#)
- SetRGB8, [534](#)
- gdcmm::ImageChangePhotometricInterpretation, [535](#)
- ~ImageChangePhotometricInterpretation, [537](#)
- Change, [537](#)
- ChangeMonochrome, [538](#)
- ChangeRGB2YBR, [538](#)
- ChangeYBR2RGB, [538](#)
- GetPhotometricInterpretation, [538](#)
- ImageChangePhotometricInterpretation, [537](#)
- RGB2YBR, [538](#)
- SetPhotometricInterpretation, [538](#)
- YBR2RGB, [539](#)
- gdcmm::ImageChangePlanarConfiguration, [539](#)
- ~ImageChangePlanarConfiguration, [541](#)
- Change, [541](#)
- GetPlanarConfiguration, [541](#)
- ImageChangePlanarConfiguration, [541](#)
- RGBPixelsToRGBPlanes, [542](#)
- RGBPlanesToRGBPixels, [542](#)
- SetPlanarConfiguration, [542](#)
- gdcmm::ImageChangeTransferSyntax, [543](#)
- ~ImageChangeTransferSyntax, [545](#)
- Change, [546](#)
- GetTransferSyntax, [546](#)
- ImageChangeTransferSyntax, [545](#)
- SetCompressIconImage, [546](#)
- SetForce, [546](#)
- SetTransferSyntax, [546](#)
- SetUserCodec, [547](#)
- TryJPEG2000Codec, [547](#)
- TryJPEGCodec, [547](#)
- TryJPEGLSCodec, [547](#)
- TryRAWCodec, [548](#)
- TryRLECodec, [548](#)
- gdcmm::ImageCodec, [548](#)
- ~ImageCodec, [551](#)
- AppendFrameEncode, [551](#)
- AppendRowEncode, [551](#)
- CanCode, [552](#)
- CanDecode, [552](#)
- CleanupUnusedBits, [552](#)
- Clone, [552](#)
- Decode, [553](#)
- DecodeByStreams, [553](#)
- Dimensions, [560](#)
- DoByteSwap, [553](#)
- DoInvertMonochrome, [553](#)
- DoOverlayCleanup, [554](#)
- DoPaddedCompositePixelCode, [554](#)
- DoPlanarConfiguration, [554](#)
- DoSimpleCopy, [554](#)
- DoYBR, [554](#)
- DoYBRFull422, [554](#)
- FileChangeTransferSyntax, [560](#)
- GetDimensions, [555](#)
- GetHeaderInfo, [555](#)
- GetLossyFlag, [555](#)
- GetLUT, [555](#)
- GetNeedByteSwap, [555](#)
- GetNumberOfDimensions, [555](#)
- GetPhotometricInterpretation, [556](#)
- GetPixelFormat, [556](#)
- GetPlanarConfiguration, [556](#)
- ImageChangePhotometricInterpretation, [560](#)
- ImageCodec, [551](#)
- IsFrameEncoder, [556](#)
- IsLossy, [556](#)
- IsRowEncoder, [557](#)
- IsValid, [557](#)
- LossyFlag, [560](#)
- LUT, [560](#)
- LUTPtr, [551](#)
- NeedByteSwap, [560](#)
- NeedOverlayCleanup, [561](#)
- NumberOfDimensions, [561](#)
- PF, [561](#)
- PI, [561](#)
- PlanarConfiguration, [561](#)
- RequestPaddedCompositePixelCode, [561](#)
- RequestPlanarConfiguration, [561](#)
- SetDimensions, [557](#)
- SetLossyFlag, [557](#)

- SetLUT, [558](#)
- SetNeedByteSwap, [558](#)
- SetNeedOverlayCleanup, [558](#)
- SetNumberOfDimensions, [558](#)
- SetPhotometricInterpretation, [558](#)
- SetPixelFormat, [559](#)
- SetPlanarConfiguration, [559](#)
- StartEncode, [559](#)
- StopEncode, [559](#)
- gdcm::ImageConverter, [562](#)
  - ~ImageConverter, [562](#)
  - Convert, [563](#)
  - GetOutput, [563](#)
  - ImageConverter, [562](#)
  - SetInput, [563](#)
- gdcm::ImageFragmentSplitter, [564](#)
  - ~ImageFragmentSplitter, [566](#)
  - GetFragmentSizeMax, [566](#)
  - ImageFragmentSplitter, [566](#)
  - SetForce, [566](#)
  - SetFragmentSizeMax, [566](#)
  - Split, [567](#)
- gdcm::ImageHelper, [567](#)
  - ComputeMediaStorageFromModality, [568](#)
  - ComputeSpacingFromImagePositionPatient, [568](#)
  - GetDimensionsValue, [569](#)
  - GetDirectionCosinesFromDataSet, [569](#)
  - GetDirectionCosinesValue, [569](#)
  - GetForcePixelSpacing, [569](#)
  - GetForceRescaleInterceptSlope, [569](#)
  - GetLUT, [570](#)
  - GetOriginValue, [570](#)
  - GetPhotometricInterpretationValue, [570](#)
  - GetPixelFormatValue, [570](#)
  - GetPlanarConfigurationValue, [570](#)
  - GetPMSRescaleInterceptSlope, [570](#)
  - GetPointerFromElement, [571](#)
  - GetRealWorldValueMappingContent, [571](#)
  - GetRescaleInterceptSlopeValue, [571](#)
  - GetSpacingTagFromMediaStorage, [571](#)
  - GetSpacingValue, [571](#)
  - GetZSpacingTagFromMediaStorage, [572](#)
  - SetDimensionsValue, [572](#)
  - SetDirectionCosinesValue, [572](#)
  - SetForcePixelSpacing, [572](#)
  - SetForceRescaleInterceptSlope, [572](#)
  - SetOriginValue, [573](#)
  - SetPMSRescaleInterceptSlope, [573](#)
  - SetRescaleInterceptSlopeValue, [573](#)
  - SetSpacingValue, [573](#)
- gdcm::ImageReader, [574](#)
  - ~ImageReader, [576](#)
  - GetImage, [576](#)
  - ImageReader, [576](#)
- Read, [577](#)
- ReadACRNEMAImage, [577](#)
- ReadImage, [577](#)
- gdcm::ImageRegionReader, [578](#)
  - ~ImageRegionReader, [580](#)
  - ComputeBufferLength, [580](#)
  - GetRegion, [581](#)
  - ImageRegionReader, [580](#)
  - Read, [581](#)
  - ReadInformation, [581](#)
  - ReadIntoBuffer, [581](#)
  - SetRegion, [582](#)
- gdcm::ImageToImageFilter, [582](#)
  - ~ImageToImageFilter, [584](#)
  - GetInput, [584](#)
  - GetOutput, [584](#)
  - ImageToImageFilter, [584](#)
- gdcm::ImageWriter, [585](#)
  - ~ImageWriter, [587](#)
  - ComputeTargetMediaStorage, [587](#)
  - GetImage, [588](#)
  - ImageWriter, [587](#)
  - Write, [588](#)
- gdcm::ImplicitDataElement, [593](#)
  - GetLength, [594](#)
  - Read, [594](#)
  - ReadPreValue, [594](#)
  - ReadValue, [594](#)
  - ReadValueWithLength, [595](#)
  - ReadWithLength, [595](#)
  - Write, [595](#)
- gdcm::InitializeEvent, [596](#)
- gdcm::IOD, [597](#)
  - AddIODEntry, [598](#)
  - Clear, [598](#)
  - GetIODEntry, [598](#)
  - GetNumberOfIODs, [598](#)
  - GetTypeFromTag, [599](#)
  - IOD, [598](#)
  - MapIODEntry, [597](#)
  - operator<<, [599](#)
  - SizeType, [598](#)
- gdcm::IODEntry, [599](#)
  - GetIE, [600](#)
  - GetName, [601](#)
  - GetRef, [601](#)
  - GetUsage, [601](#)
  - GetUsageType, [601](#)
  - IODEntry, [600](#)
  - operator<<, [602](#)
  - SetIE, [601](#)
  - SetName, [601](#)
  - SetRef, [601](#)
  - SetUsage, [602](#)

- gdcmm::IODs, 602
  - AddIOD, 604
  - Begin, 604
  - Clear, 604
  - End, 604
  - GetIOD, 605
  - IODMapType, 603
  - IODMapTypeConstIterator, 603
  - IODName, 603
  - IODs, 604
  - operator<<, 605
- gdcmm::IPPSorter, 605
  - ComputeZSpacing, 609
  - DirCosTolerance, 609
  - DropDuplicatePositions, 610
  - GetDirectionCosinesTolerance, 607
  - GetZSpacing, 607
  - GetZSpacingTolerance, 608
  - IPPSorter, 607
  - SetComputeZSpacing, 608
  - SetDirectionCosinesTolerance, 608
  - SetDropDuplicatePositions, 608
  - SetZSpacingTolerance, 609
  - Sort, 609
  - ZSpacing, 610
  - ZTolerance, 610
- gdcmm::Item, 610
  - Clear, 612
  - FindDataElement, 613
  - GetDataElement, 613
  - GetLength, 613
  - GetNestedDataSet, 613
  - InsertDataElement, 613
  - Item, 612
  - operator<<, 614
  - Read, 614
  - SetNestedDataSet, 614
  - Write, 614
- gdcmm::IterationEvent, 615
- gdcmm::JPEG12Codec, 616
  - ~JPEG12Codec, 617
  - DecodeByStreams, 617
  - EncodeBuffer, 618
  - GetHeaderInfo, 618
  - InternalCode, 618
  - IsStateSuspension, 618
  - JPEG12Codec, 617
- gdcmm::JPEG16Codec, 619
  - ~JPEG16Codec, 620
  - DecodeByStreams, 620
  - EncodeBuffer, 621
  - GetHeaderInfo, 621
  - InternalCode, 621
  - IsStateSuspension, 621
  - JPEG16Codec, 620
- gdcmm::JPEG2000Codec, 622
  - ~JPEG2000Codec, 624
  - AppendFrameEncode, 624
  - AppendRowEncode, 624
  - Bitmap, 629
  - CanCode, 624
  - CanDecode, 625
  - Clone, 625
  - Code, 625
  - Decode, 625
  - DecodeByStreams, 626
  - DecodeExtent, 626
  - GetHeaderInfo, 626
  - GetQuality, 626
  - GetRate, 627
  - ImageRegionReader, 629
  - IsFrameEncoder, 627
  - IsRowEncoder, 627
  - JPEG2000Codec, 624
  - SetMCT, 627
  - SetNumberOfResolutions, 627
  - SetNumberOfThreadsForDecompression, 627
  - SetQuality, 628
  - SetRate, 628
  - SetReversible, 628
  - SetTitleSize, 628
  - StartEncode, 628
  - StopEncode, 628
- gdcmm::JPEG8Codec, 629
  - ~JPEG8Codec, 631
  - DecodeByStreams, 631
  - EncodeBuffer, 631
  - GetHeaderInfo, 632
  - InternalCode, 632
  - IsStateSuspension, 632
  - JPEG8Codec, 631
- gdcmm::JPEGCodec, 633
  - ~JPEGCodec, 635
  - AppendFrameEncode, 635
  - AppendRowEncode, 636
  - BitSample, 641
  - CanCode, 636
  - CanDecode, 636
  - Clone, 636
  - Code, 637
  - ComputeOffsetTable, 637
  - Decode, 637
  - DecodeByStreams, 637
  - DecodeExtent, 637
  - EncodeBuffer, 638
  - GetHeaderInfo, 638
  - GetLossless, 638
  - GetQuality, 638

- ImageRegionReader, [641](#)
- IsFrameEncoder, [639](#)
- IsRowEncoder, [639](#)
- IsStateSuspension, [639](#)
- IsValid, [639](#)
- JPEGCodec, [635](#)
- Quality, [641](#)
- SetBitSample, [639](#)
- SetLossless, [639](#)
- SetPixelFormat, [640](#)
- SetQuality, [640](#)
- StartEncode, [640](#)
- StopEncode, [640](#)
- gdcmm::JPEGLSCodec, [641](#)
  - ~JPEGLSCodec, [644](#)
  - AppendFrameEncode, [644](#)
  - AppendRowEncode, [644](#)
  - CanCode, [644](#)
  - CanDecode, [644](#)
  - Clone, [645](#)
  - Code, [645](#)
  - Decode, [645](#)
  - DecodeExtent, [646](#)
  - GetBufferLength, [646](#)
  - GetHeaderInfo, [646](#)
  - GetLossless, [646](#)
  - ImageRegionReader, [648](#)
  - IsFrameEncoder, [646](#)
  - IsRowEncoder, [647](#)
  - JPEGLSCodec, [643](#)
  - SetBufferLength, [647](#)
  - SetLossless, [647](#)
  - SetLossyError, [647](#)
  - StartEncode, [647](#)
  - StopEncode, [647](#)
- gdcmm::JSON, [648](#)
  - ~JSON, [649](#)
  - Code, [649](#)
  - Decode, [649](#)
  - GetPrettyPrint, [649](#)
  - JSON, [648](#)
  - PrettyPrintOff, [649](#)
  - PrettyPrintOn, [650](#)
  - SetPrettyPrint, [650](#)
- gdcmm::KAKADUCodec, [650](#)
  - ~KAKADUCodec, [652](#)
  - CanCode, [652](#)
  - CanDecode, [652](#)
  - Clone, [652](#)
  - Code, [653](#)
  - Decode, [653](#)
  - KAKADUCodec, [652](#)
- gdcmm::LO, [654](#)
  - const\_iterator, [655](#)
  - const\_reference, [655](#)
  - const\_reverse\_iterator, [655](#)
  - difference\_type, [655](#)
  - IsValid, [657](#)
  - iterator, [655](#)
  - LO, [657](#)
  - pointer, [656](#)
  - reference, [656](#)
  - reverse\_iterator, [656](#)
  - size\_type, [656](#)
  - Superclass, [656](#)
  - value\_type, [656](#)
- gdcmm::LookupTable, [658](#)
  - ~LookupTable, [660](#)
  - Allocate, [661](#)
  - BitSample, [665](#)
  - BLUE, [660](#)
  - Clear, [661](#)
  - Decode, [661](#)
  - Decode8, [661](#)
  - GetBitSample, [662](#)
  - GetBufferAsRGBA, [662](#)
  - GetLUT, [662](#)
  - GetLUTDescriptor, [662](#)
  - GetLUTLength, [663](#)
  - GetPointer, [663](#)
  - GRAY, [660](#)
  - GREEN, [660](#)
  - IncompleteLUT, [666](#)
  - InitializeBlueLUT, [663](#)
  - Initialized, [663](#)
  - InitializeGreenLUT, [663](#)
  - InitializeLUT, [664](#)
  - InitializeRedLUT, [664](#)
  - Internal, [666](#)
  - IsRGB8, [664](#)
  - LookupTable, [660](#)
  - LookupTableType, [660](#)
  - Print, [664](#)
  - RED, [660](#)
  - SetBlueLUT, [664](#)
  - SetGreenLUT, [665](#)
  - SetLUT, [665](#)
  - SetRedLUT, [665](#)
  - UNKNOWN, [660](#)
  - WriteBufferAsRGBA, [665](#)
- gdcmm::Macro, [667](#)
  - AddMacroEntry, [668](#)
  - ArrayIncludeMacrosType, [668](#)
  - Clear, [669](#)
  - FindMacroEntry, [669](#)
  - GetMacroEntry, [669](#)
  - GetName, [669](#)
  - Macro, [668](#)

- MapModuleEntry, [668](#)
- operator<<, [670](#)
- SetName, [669](#)
- Verify, [669](#)
- gdcM::Macros, [670](#)
  - AddMacro, [671](#)
  - Clear, [671](#)
  - GetMacro, [672](#)
  - IsEmpty, [672](#)
  - Macros, [671](#)
  - ModuleMapType, [671](#)
  - operator<<, [672](#)
- gdcM::MD5, [674](#)
  - Compute, [675](#)
  - ComputeFile, [675](#)
- gdcM::MediaStorage, [675](#)
  - AmbulatoryECGWaveformStorage, [680](#)
  - Audio, [682](#)
  - BasicTextSR, [680](#)
  - BasicVoiceAudioWaveformStorage, [680](#)
  - BreastProjectionXRayImageStorageForPresentation, [681](#)
  - BreastProjectionXRayImageStorageForProcessing, [681](#)
  - BreastTomosynthesisImageStorage, [681](#)
  - CardiacElectrophysiologyWaveformStorage, [680](#)
  - ComprehensiveSR, [680](#)
  - ComputedRadiographyImageStorage, [679](#)
  - CSANonImageStorage, [680](#)
  - CTImageStorage, [679](#)
  - DetachedPatientManagementSOPClass, [680](#)
  - DetachedStudyManagementSOPClass, [680](#)
  - DetachedVisitManagementSOPClass, [680](#)
  - DigitalIntraoralXRayImageStorageForPresentation, [679](#)
  - DigitalIntraoralXRayImageStorageForProcessing, [679](#)
  - DigitalMammographyImageStorageForPresentation, [679](#)
  - DigitalMammographyImageStorageForProcessing, [679](#)
  - DigitalXRayImageStorageForPresentation, [679](#)
  - DigitalXRayImageStorageForProcessing, [679](#)
  - EncapsulatedCDASStorage, [680](#)
  - EncapsulatedPDFStorage, [680](#)
  - EnhancedCTImageStorage, [679](#)
  - EnhancedMRCOLORImageStorage, [681](#)
  - EnhancedMRIImageStorage, [680](#)
  - EnhancedPETImageStorage, [681](#)
  - EnhancedSR, [680](#)
  - EnhancedUSVolumeStorage, [681](#)
  - EnhancedXAImageStorage, [681](#)
  - FujiPrivateCRImageStorage, [681](#)
  - FujiPrivateMammoCRImageStorage, [681](#)
  - GeneralECGWaveformStorage, [680](#)
  - GeneralElectricMagneticResonanceImageStorage, [681](#)
  - GEPrivate3DModelStorage, [681](#)
  - GetModality, [682](#)
  - GetModalityDimension, [682](#)
  - GetMSString, [683](#)
  - GetMSType, [683](#)
  - GetNumberOfModality, [683](#)
  - GetNumberOfMSString, [683](#)
  - GetNumberOfMSType, [683](#)
  - GetString, [684](#)
  - GrayscaleSoftcopyPresentationStateStorageSOPClass, [680](#)
  - GuessFromModality, [684](#)
  - HangingProtocolStorage, [681](#)
  - HardcopyColorImageStorage, [681](#)
  - HardcopyGrayscaleImageStorage, [680](#)
  - HemodynamicWaveformStorage, [680](#)
  - IsImage, [684](#)
  - IsUndefined, [684](#)
  - IVOCTForPresentation, [681](#)
  - IVOCTForProcessing, [681](#)
  - KeyObjectSelectionDocument, [681](#)
  - LeadECGWaveformStorage, [680](#)
  - LegacyConvertedEnhancedCTImageStorage, [681](#)
  - LegacyConvertedEnhancedMRIImageStorage, [681](#)
  - LegacyConvertedEnhancedPETImageStorage, [681](#)
  - MammographyCADSR, [681](#)
  - MediaStorage, [682](#)
  - MediaStorageDirectoryStorage, [679](#)
  - ModalityPerformedProcedureStepSOPClass, [681](#)
  - MRIImageStorage, [679](#)
  - MRSpectroscopyStorage, [680](#)
  - MS\_END, [681](#)
  - MSType, [679](#)
  - MultiframeGrayscaleByteSecondaryCaptureImageStorage, [680](#)
  - MultiframeGrayscaleWordSecondaryCaptureImageStorage, [680](#)
  - MultiframeSingleBitSecondaryCaptureImageStorage, [680](#)
  - MultiframeTrueColorSecondaryCaptureImageStorage, [680](#)
  - NoObject, [682](#)
  - NuclearMedicineImageStorage, [680](#)
  - NuclearMedicineImageStorageRetired, [680](#)
  - ObjectEnd, [682](#)
  - ObjectType, [682](#)
  - operator MSType, [685](#)
  - operator<<, [686](#)
  - OphthalmicPhotography16BitImageStorage, [681](#)
  - OphthalmicPhotography8BitImageStorage, [681](#)
  - OphthalmicTomographyImageStorage, [681](#)



- PDF, [682](#)
- PETImageStorage, [680](#)
- Philips3D, [680](#)
- PhilipsPrivateMRSyntheticImageStorage, [681](#)
- RawDataStorage, [680](#)
- RTDoseStorage, [680](#)
- RTImageStorage, [680](#)
- RTIonBeamsTreatmentRecordStorage, [681](#)
- RTIonPlanStorage, [681](#)
- RTPlanStorage, [680](#)
- RTStructureSetStorage, [680](#)
- RTTreatmentSummaryRecordStorage, [681](#)
- SecondaryCaptureImageStorage, [680](#)
- Segmentation, [682](#)
- SegmentationStorage, [681](#)
- SetFromDataSet, [685](#)
- SetFromFile, [685](#)
- SetFromHeader, [685](#)
- SetFromModality, [685](#)
- SetFromSourceImageSequence, [686](#)
- SpacialFiducialsStorage, [680](#)
- SpacialRegistrationStorage, [680](#)
- StandaloneCurveStorage, [680](#)
- StandaloneModalityLUTStorage, [680](#)
- StandaloneOverlayStorage, [680](#)
- StandaloneVOILUTStorage, [680](#)
- StudyComponentManagementSOPClass, [680](#)
- SurfaceSegmentationStorage, [681](#)
- ToshibaPrivateDataStorage, [681](#)
- UltrasoundImageStorage, [679](#)
- UltrasoundImageStorageRetired, [679](#)
- UltrasoundMultiFrameImageStorage, [679](#)
- UltrasoundMultiFrameImageStorageRetired, [679](#)
- URI, [682](#)
- Video, [682](#)
- VideoEndoscopicImageStorage, [681](#)
- VideoMicroscopicImageStorage, [681](#)
- VideoPhotographicImageStorage, [681](#)
- VLEndoscopicImageStorage, [681](#)
- VLMicroscopicImageStorage, [681](#)
- VLPhotographicImageStorage, [681](#)
- VLWholeSlideMicroscopyImageStorage, [681](#)
- Waveform, [682](#)
- XRay3DAngiographicImageStorage, [681](#)
- XRay3DCraniofacialImageStorage, [681](#)
- XRayAngiographicBiPlanarImageStorageRetired, [680](#)
- XRayAngiographicImageStorage, [680](#)
- XRayRadiationDoseSR, [681](#)
- XRayRadiofluoroscopicImageStorage, [680](#)
- gdcM::MemberCommand< T >, [686](#)
- ~MemberCommand, [689](#)
- Execute, [690](#)
- m\_ConstMemberFunction, [691](#)
- m\_MemberFunction, [691](#)
- m\_This, [692](#)
- MemberCommand, [689](#)
- New, [690](#)
- operator=, [690](#)
- Self, [688](#)
- SetCallbackFunction, [691](#)
- TConstMemberFunctionPointer, [689](#)
- TMemberFunctionPointer, [689](#)
- gdcM::MeshPrimitive, [692](#)
- ~MeshPrimitive, [695](#)
- AddPrimitiveData, [695](#)
- EDGE, [695](#)
- FACET, [695](#)
- GetMPType, [695](#)
- GetMPTypeString, [695](#)
- GetNumberOfPrimitivesData, [696](#)
- GetPrimitiveData, [696](#)
- GetPrimitivesData, [696](#)
- GetPrimitiveType, [697](#)
- LINE, [695](#)
- MeshPrimitive, [695](#)
- MPType, [694](#)
- MPType\_END, [695](#)
- PrimitiveData, [697](#)
- PrimitivesData, [694](#)
- PrimitiveType, [698](#)
- SetPrimitiveData, [697](#)
- SetPrimitivesData, [697](#)
- SetPrimitiveType, [697](#)
- TRIANGLE, [695](#)
- TRIANGLE\_FAN, [695](#)
- TRIANGLE\_STRIP, [695](#)
- VERTEX, [695](#)
- gdcM::ModalityPerformedProcedureStepCreateQuery, [698](#)
- GetAbstractSyntaxUID, [700](#)
- GetRequiredDataSet, [700](#)
- ModalityPerformedProcedureStepCreateQuery, [700](#)
- QueryFactory, [700](#)
- ValidateQuery, [700](#)
- gdcM::ModalityPerformedProcedureStepSetQuery, [701](#)
- GetAbstractSyntaxUID, [703](#)
- GetRequiredDataSet, [703](#)
- ModalityPerformedProcedureStepSetQuery, [703](#)
- QueryFactory, [703](#)
- ValidateQuery, [703](#)
- gdcM::ModifiedEvent, [704](#)
- gdcM::Module, [705](#)
- AddMacro, [706](#)
- AddModuleEntry, [706](#)
- ArrayIncludeMacroType, [706](#)
- Clear, [706](#)
- FindModuleEntryInMacros, [707](#)
- GetModuleEntryInMacros, [707](#)



- GetName, [707](#)
- MapModuleEntry, [706](#)
- Module, [706](#)
- operator<<, [707](#)
- SetName, [707](#)
- Verify, [707](#)
- gdcM::ModuleEntry, [708](#)
  - ~ModuleEntry, [710](#)
  - DataElementType, [712](#)
  - Description, [710](#)
  - DescriptionField, [712](#)
  - GetDescription, [710](#)
  - GetName, [711](#)
  - GetType, [711](#)
  - ModuleEntry, [710](#)
  - Name, [712](#)
  - operator<<, [711](#)
  - SetDescription, [711](#)
  - SetName, [711](#)
  - SetType, [711](#)
- gdcM::Modules, [712](#)
  - AddModule, [714](#)
  - Clear, [714](#)
  - GetModule, [714](#)
  - IsEmpty, [714](#)
  - ModuleMapType, [713](#)
  - Modules, [713](#)
  - operator<<, [714](#)
- gdcM::MovePatientRootQuery, [715](#)
  - GetAbstractSyntaxUID, [716](#)
  - GetTagListByLevel, [716](#)
  - InitializeDataSet, [716](#)
  - MovePatientRootQuery, [716](#)
  - QueryFactory, [717](#)
  - ValidateQuery, [717](#)
- gdcM::MoveStudyRootQuery, [718](#)
  - GetAbstractSyntaxUID, [719](#)
  - GetTagListByLevel, [719](#)
  - InitializeDataSet, [719](#)
  - MoveStudyRootQuery, [719](#)
  - QueryFactory, [720](#)
  - ValidateQuery, [720](#)
- gdcM::MrProtocol, [720](#)
  - ~MrProtocol, [721](#)
  - FindMrProtocolByName, [722](#)
  - GetMrProtocolByName, [722](#)
  - GetSliceArray, [722](#)
  - GetVersion, [722](#)
  - Load, [722](#)
  - MrProtocol, [721](#)
  - operator<<, [723](#)
  - Print, [722](#)
- gdcM::MrProtocol::Slice, [1001](#)
  - Normal, [1001](#)
  - Position, [1001](#)
- gdcM::MrProtocol::SliceArray, [1002](#)
  - Slices, [1002](#)
- gdcM::MrProtocol::Vector3, [1274](#)
  - dCor, [1274](#)
  - dSag, [1274](#)
  - dTra, [1274](#)
- gdcM::NestedModuleEntries, [732](#)
  - AddModuleEntry, [734](#)
  - GetModuleEntry, [734](#)
  - GetNumberOfModuleEntries, [734](#)
  - NestedModuleEntries, [733](#)
  - operator<<, [734](#)
  - SizeType, [733](#)
- gdcM::network, [77](#)
  - cMaxEventID, [83](#)
  - cMaxStateID, [83](#)
  - eAABORTPDUReturnedOpen, [81](#)
  - eAABORTRequest, [81](#)
  - eAASSOCIATE\_RQPDUReturned, [81](#)
  - eAASSOCIATERequestLocalUser, [81](#)
  - eAASSOCIATEResponseAccept, [81](#)
  - eAASSOCIATEResponseReject, [81](#)
  - eARELEASE\_RPPDUReturned, [81](#)
  - eARELEASE\_RQPDUReturnedOpen, [81](#)
  - eARELEASERRequest, [81](#)
  - eARELEASEResponse, [81](#)
  - eARTIMTimerExpired, [81](#)
  - eASSOCIATE\_ACPDUReturned, [81](#)
  - eASSOCIATE\_RJPDUReturned, [81](#)
  - eEventDoesNotExist, [81](#)
  - EEventID, [81](#)
  - ePDATArequest, [81](#)
  - ePDATATFPDU, [81](#)
  - eSta10ReleaseCollisionAc, [83](#)
  - eSta11ReleaseCollisionRq, [83](#)
  - eSta12ReleaseCollisionAcLocal, [83](#)
  - eSta13AwaitingClose, [83](#)
  - eSta1Idle, [83](#)
  - eSta2Open, [83](#)
  - eSta3WaitLocalAssoc, [83](#)
  - eSta4LocalAssocDone, [83](#)
  - eSta5WaitRemoteAssoc, [83](#)
  - eSta6TransferReady, [83](#)
  - eSta7WaitRelease, [83](#)
  - eSta8WaitLocalRelease, [83](#)
  - eSta9ReleaseCollisionRqLocal, [83](#)
  - eStaDoesNotExist, [83](#)
  - EStateID, [81](#)
  - eTransportConnConfirmLocal, [81](#)
  - eTransportConnectionClosed, [81](#)
  - eTransportConnIndicLocal, [81](#)
  - eUnrecognizedPDUReturned, [81](#)
  - GetStateIndex, [83](#)

- gdcmm::network::AAAbortPDU, 87
  - AAAbortPDU, 88
  - IsLastFragment, 88
  - Print, 88
  - Read, 88
  - SetReason, 89
  - SetSource, 89
  - Size, 89
  - Write, 89
- gdcmm::network::AAssociateACPDU, 90
  - AAssociateACPDU, 91
  - AAssociateRQPDU, 94
  - AddPresentationContextAC, 92
  - GetNumberOfPresentationContextAC, 92
  - GetPresentationContextAC, 92
  - GetUserInformation, 92
  - InitFromRQ, 92
  - IsLastFragment, 92
  - Print, 93
  - Read, 93
  - SetCalledAETitle, 93
  - SetCallingAETitle, 93
  - Size, 93
  - SizeType, 91
  - Write, 93
- gdcmm::network::AAssociateRJPDU, 94
  - AAssociateRJPDU, 95
  - IsLastFragment, 95
  - Print, 96
  - Read, 96
  - Size, 96
  - Write, 96
- gdcmm::network::AAssociateRQPDU, 97
  - AAssociateACPDU, 103
  - AAssociateRQPDU, 99
  - AddPresentationContext, 99
  - GetCalledAETitle, 99
  - GetCallingAETitle, 99
  - GetNumberOfPresentationContext, 100
  - GetPresentationContext, 100
  - GetPresentationContextByAbstractSyntax, 100
  - GetPresentationContextByID, 100
  - GetPresentationContexts, 100
  - GetReserved43\_74, 100
  - GetUserInformation, 101
  - IsAETitleValid, 101
  - IsLastFragment, 101
  - PresentationContextArrayType, 98
  - Print, 101
  - Read, 101
  - SetCalledAETitle, 102
  - SetCallingAETitle, 102
  - SetUserInformation, 102
  - Size, 102
  - SizeType, 99
  - Write, 102
- gdcmm::network::AbstractSyntax, 104
  - AbstractSyntax, 105
  - GetAsDataElement, 105
  - GetName, 105
  - operator==, 105
  - Print, 105
  - Read, 105
  - SetName, 106
  - SetNameFromUID, 106
  - Size, 106
  - Write, 106
- gdcmm::network::ApplicationContext, 119
  - ApplicationContext, 120
  - GetName, 120
  - Print, 120
  - Read, 120
  - SetName, 120
  - Size, 120
  - Write, 121
- gdcmm::network::AReleaseRPPDU, 124
  - AReleaseRPPDU, 125
  - IsLastFragment, 125
  - Print, 125
  - Read, 125
  - Size, 126
  - Write, 126
- gdcmm::network::AReleaseRQPDU, 126
  - AReleaseRQPDU, 127
  - IsLastFragment, 127
  - Print, 128
  - Read, 128
  - Size, 128
  - Write, 128
- gdcmm::network::ARTIMTimer, 129
  - ARTIMTimer, 129
  - GetElapsedTime, 129
  - GetHasExpired, 130
  - GetTimeout, 130
  - SetTimeout, 130
  - Start, 130
  - Stop, 130
- gdcmm::network::AsynchronousOperationsWindowSub, 132
  - AsynchronousOperationsWindowSub, 133
  - Print, 133
  - Read, 133
  - Size, 133
  - Write, 134
- gdcmm::network::BaseCompositeMessage, 171
  - ~BaseCompositeMessage, 172
  - ConstructPDV, 172
- gdcmm::network::BaseNormalizedMessage, 173

- ~BaseNormalizedMessage, [174](#)
- ConstructPDV, [174](#)
- gdcmm::network::BasePDU, [175](#)
  - ~BasePDU, [176](#)
  - IsLastFragment, [176](#)
  - Print, [176](#)
  - Read, [176](#)
  - Size, [177](#)
  - Write, [177](#)
- gdcmm::network::CEchoRQ, [237](#)
  - AffectedSOPClassUID, [238](#)
  - ConstructPDV, [238](#)
  - MessageID, [238](#)
- gdcmm::network::CEchoRSP, [239](#)
  - ConstructPDVByDataSet, [240](#)
- gdcmm::network::CFind, [240](#)
- gdcmm::network::CFindCancelRQ, [240](#)
  - ConstructPDVByDataSet, [241](#)
- gdcmm::network::CFindRQ, [242](#)
  - ConstructPDV, [243](#)
- gdcmm::network::CFindRSP, [243](#)
  - ConstructPDVByDataSet, [244](#)
- gdcmm::network::CMoveCancelRq, [245](#)
  - ConstructPDVByDataSet, [245](#)
- gdcmm::network::CMoveRQ, [246](#)
  - ConstructPDV, [247](#)
- gdcmm::network::CMoveRSP, [247](#)
  - ConstructPDVByDataSet, [248](#)
- gdcmm::network::CompositeMessageFactory, [263](#)
  - ConstructCEchoRQ, [263](#)
  - ConstructCFindRQ, [263](#)
  - ConstructCMoveRQ, [263](#)
  - ConstructCStoreRQ, [264](#)
  - ConstructCStoreRSP, [264](#)
- gdcmm::network::CStoreRQ, [300](#)
  - ConstructPDV, [301](#)
- gdcmm::network::CStoreRSP, [301](#)
  - ConstructPDV, [302](#)
- gdcmm::network::DIMSE, [380](#)
  - C\_CANCEL\_RQ, [381](#)
  - C\_ECHO\_RQ, [381](#)
  - C\_ECHO\_RSP, [381](#)
  - C\_FIND\_RQ, [381](#)
  - C\_FIND\_RSP, [381](#)
  - C\_GET\_RQ, [381](#)
  - C\_GET\_RSP, [381](#)
  - C\_MOVE\_RQ, [381](#)
  - C\_MOVE\_RSP, [381](#)
  - C\_STORE\_RQ, [381](#)
  - C\_STORE\_RSP, [381](#)
  - CommandTypes, [381](#)
  - N\_ACTION\_RQ, [381](#)
  - N\_ACTION\_RSP, [381](#)
  - N\_CREATE\_RQ, [381](#)
  - N\_CREATE\_RSP, [381](#)
  - N\_DELETE\_RQ, [381](#)
  - N\_DELETE\_RSP, [381](#)
  - N\_EVENT\_REPORT\_RQ, [381](#)
  - N\_EVENT\_REPORT\_RSP, [381](#)
  - N\_GET\_RQ, [381](#)
  - N\_GET\_RSP, [381](#)
  - N\_SET\_RQ, [381](#)
  - N\_SET\_RSP, [381](#)
- gdcmm::network::ImplementationClassUIDSub, [589](#)
  - ImplementationClassUIDSub, [589](#)
  - Print, [589](#)
  - Read, [589](#)
  - Size, [590](#)
  - Write, [590](#)
- gdcmm::network::ImplementationUIDSub, [590](#)
  - ImplementationUIDSub, [590](#)
  - Write, [591](#)
- gdcmm::network::ImplementationVersionNameSub, [591](#)
  - ImplementationVersionNameSub, [591](#)
  - Print, [592](#)
  - Read, [592](#)
  - Size, [592](#)
  - Write, [592](#)
- gdcmm::network::MaximumLengthSub, [672](#)
  - GetMaximumLength, [673](#)
  - MaximumLengthSub, [673](#)
  - Print, [673](#)
  - Read, [673](#)
  - SetMaximumLength, [674](#)
  - Size, [674](#)
  - Write, [674](#)
- gdcmm::network::NActionRQ, [723](#)
  - ConstructPDV, [724](#)
- gdcmm::network::NActionRSP, [724](#)
  - ConstructPDVByDataSet, [725](#)
- gdcmm::network::NCreateRQ, [726](#)
  - ConstructPDV, [727](#)
- gdcmm::network::NCreateRSP, [727](#)
  - ConstructPDVByDataSet, [728](#)
- gdcmm::network::NDeleteRQ, [729](#)
  - ConstructPDV, [730](#)
- gdcmm::network::NDeleteRSP, [730](#)
  - ConstructPDVByDataSet, [731](#)
- gdcmm::network::NEventReportRQ, [735](#)
  - ConstructPDV, [736](#)
- gdcmm::network::NEventReportRSP, [736](#)
  - ConstructPDVByDataSet, [737](#)
- gdcmm::network::NGetRQ, [738](#)
  - ConstructPDV, [739](#)
- gdcmm::network::NGetRSP, [739](#)
  - ConstructPDVByDataSet, [740](#)
- gdcmm::network::NormalizedMessageFactory, [742](#)
  - ConstructNAction, [742](#)

- ConstructNCreate, 742
- ConstructNDelete, 742
- ConstructNEventReport, 743
- ConstructNGet, 743
- ConstructNSet, 743
- gdcn::network::NSetRQ, 746
  - ConstructPDV, 747
- gdcn::network::NSetRSP, 748
  - ConstructPDVByDataSet, 749
- gdcn::network::PDataTFPDU, 785
  - AddPresentationDataValue, 786
  - GetNumberOfPresentationDataValues, 786
  - GetPresentationDataValue, 787
  - IsLastFragment, 787
  - PDataTFPDU, 786
  - Print, 787
  - Read, 787
  - ReadInto, 787
  - Size, 787
  - SizeType, 786
  - Write, 788
- gdcn::network::PDUFactory, 797
  - ConstructAbortPDU, 798
  - ConstructPDU, 798
  - ConstructReleasePDU, 798
  - CreateCEchoPDU, 798
  - CreateCFindPDU, 798
  - CreateCMovePDU, 798
  - CreateCStoreRQPDU, 799
  - CreateCStoreRSPPDU, 799
  - CreateNActionPDU, 799
  - CreateNCreatePDU, 799
  - CreateNDeletePDU, 799
  - CreateNEventReportPDU, 799
  - CreateNGetPDU, 800
  - CreateNSetPDU, 800
  - DetermineEventByPDU, 800
  - GetPDVs, 800
- gdcn::network::PresentationContextAC, 849
  - GetPresentationContextID, 850
  - GetReason, 850
  - GetTransferSyntax, 850
  - PresentationContextAC, 849
  - Print, 850
  - Read, 850
  - SetPresentationContextID, 850
  - SetReason, 851
  - SetTransferSyntax, 851
  - Size, 851
  - Write, 851
- gdcn::network::PresentationContextRQ, 855
  - AddTransferSyntax, 857
  - GetAbstractSyntax, 857
  - GetNumberOfTransferSyntaxes, 857
  - GetPresentationContextID, 857
  - GetTransferSyntax, 857
  - GetTransferSyntaxes, 858
  - operator==, 858
  - PresentationContextRQ, 856
  - Print, 858
  - Read, 858
  - SetAbstractSyntax, 858
  - SetPresentationContextID, 858
  - Size, 859
  - SizeType, 856
  - Write, 859
- gdcn::network::PresentationDataValue, 859
  - ConcatenatePDVBlobs, 860
  - ConcatenatePDVBlobsAsExplicit, 860
  - GetBlob, 860
  - GetIsCommand, 861
  - GetIsLastFragment, 861
  - GetMessageHeader, 861
  - GetPresentationContextID, 861
  - PresentationDataValue, 860
  - Print, 861
  - Read, 861
  - ReadInto, 861
  - SetBlob, 862
  - SetCommand, 862
  - SetDataSet, 862
  - SetLastFragment, 862
  - SetMessageHeader, 862
  - SetPresentationContextID, 863
  - Size, 863
  - Write, 863
- gdcn::network::RoleSelectionSub, 925
  - Print, 925
  - Read, 926
  - RoleSelectionSub, 925
  - SetTuple, 926
  - Size, 926
  - Write, 926
- gdcn::network::ServiceClassApplicationInformation, 980
  - Print, 981
  - Read, 981
  - ServiceClassApplicationInformation, 980
  - SetTuple, 981
  - Size, 981
  - Write, 981
- gdcn::network::SOPClassExtendedNegotiationSub, 1007
  - Print, 1008
  - Read, 1008
  - SetTuple, 1008
  - Size, 1008
  - SOPClassExtendedNegotiationSub, 1008
  - Write, 1008

- gdcmm::network::TableRow, 1104
  - ~TableRow, 1105
  - TableRow, 1105
  - transitions, 1105
- gdcmm::network::TransferSyntaxSub, 1139
  - GetName, 1139
  - operator==, 1140
  - Print, 1140
  - Read, 1140
  - SetName, 1140
  - SetNameFromUID, 1140
  - Size, 1140
  - TransferSyntaxSub, 1139
  - Write, 1141
- gdcmm::network::Transition, 1141
  - ~Transition, 1142
  - mAction, 1143
  - MakeNew, 1142
  - mEnd, 1143
  - Transition, 1142
- gdcmm::network::ULAction, 1187
  - ~ULAction, 1188
  - operator=, 1189
  - PerformAction, 1189
  - ULAction, 1188, 1189
- gdcmm::network::ULActionAA1, 1190
  - PerformAction, 1190
- gdcmm::network::ULActionAA2, 1191
  - PerformAction, 1192
- gdcmm::network::ULActionAA3, 1192
  - PerformAction, 1193
- gdcmm::network::ULActionAA4, 1194
  - PerformAction, 1194
- gdcmm::network::ULActionAA5, 1195
  - PerformAction, 1196
- gdcmm::network::ULActionAA6, 1196
  - PerformAction, 1197
- gdcmm::network::ULActionAA7, 1198
  - PerformAction, 1198
- gdcmm::network::ULActionAA8, 1199
  - PerformAction, 1200
- gdcmm::network::ULActionAE1, 1200
  - PerformAction, 1201
- gdcmm::network::ULActionAE2, 1202
  - PerformAction, 1202
- gdcmm::network::ULActionAE3, 1203
  - PerformAction, 1204
- gdcmm::network::ULActionAE4, 1204
  - PerformAction, 1205
- gdcmm::network::ULActionAE5, 1206
  - PerformAction, 1206
- gdcmm::network::ULActionAE6, 1207
  - PerformAction, 1208
- gdcmm::network::ULActionAE7, 1208
  - PerformAction, 1209
- gdcmm::network::ULActionAE8, 1210
  - PerformAction, 1210
- gdcmm::network::ULActionAR1, 1211
  - PerformAction, 1212
- gdcmm::network::ULActionAR10, 1212
  - PerformAction, 1213
- gdcmm::network::ULActionAR2, 1214
  - PerformAction, 1214
- gdcmm::network::ULActionAR3, 1215
  - PerformAction, 1216
- gdcmm::network::ULActionAR4, 1216
  - PerformAction, 1217
- gdcmm::network::ULActionAR5, 1218
  - PerformAction, 1218
- gdcmm::network::ULActionAR6, 1219
  - PerformAction, 1220
- gdcmm::network::ULActionAR7, 1220
  - PerformAction, 1221
- gdcmm::network::ULActionAR8, 1222
  - PerformAction, 1222
- gdcmm::network::ULActionAR9, 1223
  - PerformAction, 1224
- gdcmm::network::ULActionDT1, 1224
  - PerformAction, 1225
- gdcmm::network::ULActionDT2, 1226
  - PerformAction, 1226
- gdcmm::network::ULBasicCallback, 1227
  - ~ULBasicCallback, 1228
  - GetDataSets, 1228
  - GetResponses, 1228
  - HandleDataSet, 1229
  - HandleResponse, 1229
  - ULBasicCallback, 1228
- gdcmm::network::ULConnection, 1229
  - ~ULConnection, 1231
  - AddAcceptedPresentationContext, 1231
  - FindContext, 1231
  - GetAcceptedPresentationContexts, 1231, 1232
  - GetConnectionInfo, 1232
  - GetMaxPDUSize, 1232
  - GetPresentationContextACByID, 1232
  - GetPresentationContextIDFromPresentationContext, 1232
  - GetPresentationContextRQByID, 1232
  - GetPresentationContexts, 1233
  - GetProtocol, 1233
  - GetState, 1233
  - GetTimer, 1233
  - InitializeConnection, 1233
  - InitializeIncomingConnection, 1233
  - operator=, 1234
  - SetMaxPDUSize, 1234
  - SetPresentationContexts, 1234

- SetState, [1234](#)
- StopProtocol, [1234](#)
- ULActionAE6, [1235](#)
- ULConnection, [1231](#)
- ULConnectionManager, [1235](#)
- gdcmm::network::ULConnectionCallback, [1235](#)
- ~ULConnectionCallback, [1236](#)
- DataSetHandled, [1237](#)
- DataSetHandles, [1237](#)
- HandleDataSet, [1237](#)
- HandleResponse, [1237](#)
- mImplicit, [1238](#)
- ResetHandledDataSet, [1237](#)
- SetImplicitFlag, [1237](#)
- ULConnectionCallback, [1236](#)
- gdcmm::network::ULConnectionInfo, [1238](#)
- GetCalledAETitle, [1239](#)
- GetCalledComputerName, [1239](#)
- GetCalledIPAddress, [1239](#)
- GetCalledIPPort, [1239](#)
- GetCallingAETitle, [1239](#)
- GetMaxPDULength, [1239](#)
- Initialize, [1239](#)
- SetMaxPDULength, [1240](#)
- ULConnectionInfo, [1238](#)
- gdcmm::network::ULConnectionManager, [1240](#)
- ~ULConnectionManager, [1242](#)
- BreakConnection, [1243](#)
- BreakConnectionNow, [1243](#)
- EstablishConnection, [1243](#)
- EstablishConnectionMove, [1243](#)
- mConnection, [1247](#)
- mSecondaryConnection, [1247](#)
- mTransitions, [1247](#)
- RunEventLoop, [1243](#)
- RunMoveEventLoop, [1244](#)
- SendEcho, [1244](#)
- SendFind, [1244](#)
- SendMove, [1244](#)
- SendNAction, [1245](#)
- SendNCreate, [1245](#)
- SendNDelete, [1245](#)
- SendNEventReport, [1246](#)
- SendNGet, [1246](#)
- SendNSet, [1246](#)
- SendStore, [1247](#)
- ULConnectionManager, [1242](#)
- gdcmm::network::ULEvent, [1248](#)
- ~ULEvent, [1249](#)
- GetDataSetPos, [1249](#)
- GetEvent, [1249](#)
- GetIStream, [1249](#)
- GetPDUs, [1249](#)
- SetEvent, [1250](#)
- SetPDU, [1250](#)
- ULEvent, [1248](#), [1249](#)
- gdcmm::network::ULTransitionTable, [1250](#)
- HandleEvent, [1251](#)
- PrintTable, [1251](#)
- ULTransitionTable, [1251](#)
- gdcmm::network::ULWritingCallback, [1252](#)
- ~ULWritingCallback, [1253](#)
- HandleDataSet, [1253](#)
- HandleResponse, [1253](#)
- SetDirectory, [1253](#)
- ULWritingCallback, [1253](#)
- gdcmm::network::UserInformation, [1264](#)
- ~UserInformation, [1264](#)
- AddRoleSelectionSub, [1265](#)
- AddSOPClassExtendedNegotiationSub, [1265](#)
- GetMaximumLengthSub, [1265](#)
- operator=, [1265](#)
- Print, [1265](#)
- Read, [1266](#)
- Size, [1266](#)
- UserInformation, [1264](#)
- Write, [1266](#)
- gdcmm::NoEvent, [741](#)
- gdcmm::NormalizedNetworkFunctions, [743](#)
- ConstructQuery, [744](#)
- NAction, [744](#)
- NCreate, [745](#)
- NDelete, [745](#)
- NEventReport, [745](#)
- NGet, [745](#)
- NSet, [746](#)
- gdcmm::Object, [749](#)
- ~Object, [751](#)
- Object, [751](#)
- operator<<, [752](#)
- operator=, [752](#)
- Print, [752](#)
- Register, [752](#)
- SmartPointer, [753](#)
- UnRegister, [752](#)
- gdcmm::OpenSSLCryptoFactory, [753](#)
- CreateCMSProvider, [754](#)
- InitOpenSSL, [754](#)
- OpenSSLCryptoFactory, [754](#)
- gdcmm::OpenSSLCryptographicMessageSyntax, [755](#)
- ~OpenSSLCryptographicMessageSyntax, [756](#)
- Decrypt, [756](#)
- Encrypt, [756](#)
- GetCipherType, [757](#)
- OpenSSLCryptographicMessageSyntax, [756](#)
- ParseCertificateFile, [757](#)
- ParseKeyFile, [757](#)
- SetCipherType, [757](#)

- SetPassword, [757](#)
- gdcmm::OpenSSLP7CryptoFactory, [758](#)
  - CreateCMSProvider, [759](#)
  - OpenSSLP7CryptoFactory, [759](#)
- gdcmm::OpenSSLP7CryptographicMessageSyntax, [760](#)
  - ~OpenSSLP7CryptographicMessageSyntax, [761](#)
  - Decrypt, [761](#)
  - Encrypt, [761](#)
  - GetCipherType, [762](#)
  - OpenSSLP7CryptographicMessageSyntax, [761](#)
  - ParseCertificateFile, [762](#)
  - ParseKeyFile, [762](#)
  - SetCipherType, [762](#)
  - SetPassword, [762](#)
- gdcmm::Orientation, [763](#)
  - ~Orientation, [764](#)
  - AXIAL, [764](#)
  - CORONAL, [764](#)
  - GetLabel, [765](#)
  - GetMajorAxisFromPatientRelativeDirectionCosine, [765](#)
  - GetObliquityThresholdCosineValue, [765](#)
  - GetType, [765](#)
  - OBLIQUE, [764](#)
  - operator<<, [766](#)
  - Orientation, [764](#)
  - OrientationType, [764](#)
  - Print, [765](#)
  - SAGITTAL, [764](#)
  - SetObliquityThresholdCosineValue, [766](#)
  - UNKNOWN, [764](#)
- gdcmm::Overlay, [766](#)
  - ~Overlay, [770](#)
  - Decompress, [770](#)
  - GetBitPosition, [770](#)
  - GetBitsAllocated, [770](#)
  - GetColumns, [771](#)
  - GetDescription, [771](#)
  - GetGroup, [771](#)
  - GetOrigin, [771](#)
  - GetOverlayData, [771](#)
  - GetOverlayTypeAsString, [771](#)
  - GetOverlayTypeFromString, [772](#)
  - GetRows, [772](#)
  - GetType, [772](#)
  - GetTypeAsEnum, [772](#)
  - GetUnpackBuffer, [772](#)
  - GetUnpackBufferLength, [772](#)
  - GrabOverlayFromPixelData, [773](#)
  - Graphics, [769](#)
  - Invalid, [769](#)
  - IsEmpty, [773](#)
  - IsInPixelData, [773](#)
  - IsZero, [773](#)
  - operator=, [773](#)
  - Overlay, [770](#)
  - OverlayType, [769](#)
  - Print, [774](#)
  - ROI, [769](#)
  - SetBitPosition, [774](#)
  - SetBitsAllocated, [774](#)
  - SetColumns, [774](#)
  - SetDescription, [774](#)
  - SetFrameOrigin, [775](#)
  - SetGroup, [775](#)
  - SetNumberOfFrames, [775](#)
  - SetOrigin, [775](#)
  - SetOverlay, [775](#)
  - SetRows, [776](#)
  - SetType, [776](#)
  - Update, [776](#)
- gdcmm::ParseException, [777](#)
  - ~ParseException, [778](#)
  - GetLastElement, [778](#)
  - operator=, [778](#)
  - ParseException, [778](#)
  - SetLastElement, [779](#)
- gdcmm::Parser, [779](#)
  - ~Parser, [782](#)
  - DuplicateAttributeError, [782](#)
  - EndElementHandler, [780](#)
  - ErrorType, [781](#)
  - GetBuffer, [782](#)
  - GetCurrentByteIndex, [782](#)
  - GetErrorCode, [782](#)
  - GetErrorString, [783](#)
  - GetUserData, [783](#)
  - JunkAfterDocElementError, [782](#)
  - NoElementsError, [782](#)
  - NoError, [782](#)
  - NoMemoryError, [782](#)
  - Parse, [783](#)
  - ParseBuffer, [783](#)
  - Parser, [782](#)
  - Process, [783](#)
  - SetElementHandler, [783](#)
  - SetUserData, [784](#)
  - StartElementHandler, [780](#)
  - SyntaxError, [782](#)
  - TagMismatchError, [782](#)
  - UndefinedEntityError, [782](#)
  - UnexpectedStateError, [782](#)
- gdcmm::Patient, [784](#)
  - Patient, [784](#)
- gdcmm::PDSElement, [788](#)
  - GetName, [789](#)
  - GetValue, [790](#)
  - NameField, [791](#)



- operator<<, [790](#)
- operator==, [790](#)
- PDBElement, [789](#)
- SetName, [790](#)
- SetValue, [790](#)
- ValueField, [791](#)
- gdcM::PDBHeader, [791](#)
  - ~PDBHeader, [792](#)
  - FindPDBElementByName, [793](#)
  - GetPDBEEnd, [793](#)
  - GetPDBElementByName, [793](#)
  - GetPDBInfoTag, [793](#)
  - LoadFromDataElement, [793](#)
  - operator<<, [794](#)
  - PDBHeader, [792](#)
  - Print, [794](#)
- gdcM::PDFCodec, [794](#)
  - ~PDFCodec, [796](#)
  - CanCode, [796](#)
  - CanDecode, [796](#)
  - Decode, [796](#)
  - PDFCodec, [796](#)
- gdcM::PersonName, [800](#)
  - Component, [802](#)
  - GetMaxLength, [801](#)
  - GetNumberOfComponents, [801](#)
  - MaxLength, [802](#)
  - MaxNumberOfComponents, [802](#)
  - Padding, [803](#)
  - Print, [801](#)
  - Separator, [803](#)
  - SetBlob, [802](#)
  - SetComponents, [802](#)
- gdcM::PGXCodec, [803](#)
  - ~PGXCodec, [804](#)
  - CanCode, [805](#)
  - CanDecode, [805](#)
  - Clone, [805](#)
  - GetHeaderInfo, [805](#)
  - PGXCodec, [804](#)
  - Read, [805](#)
  - Write, [806](#)
- gdcM::PhotometricInterpretation, [806](#)
  - ARGB, [808](#)
  - CMYK, [808](#)
  - GetPIString, [808](#)
  - GetPIType, [808](#)
  - GetSamplesPerPixel, [809](#)
  - GetString, [809](#)
  - GetType, [809](#)
  - HSV, [808](#)
  - IsLossless, [809](#)
  - IsLossy, [809](#)
  - IsRetired, [809](#)
  - IsSameColorSpace, [809](#)
  - MONOCHROME1, [808](#)
  - MONOCHROME2, [808](#)
  - operator PIType, [810](#)
  - operator<<, [810](#)
  - PALETTE\_COLOR, [808](#)
  - PhotometricInterpretation, [808](#)
  - PI\_END, [808](#)
  - PIType, [807](#)
  - RGB, [808](#)
  - UNKNOWN, [808](#)
  - YBR\_FULL, [808](#)
  - YBR\_FULL\_422, [808](#)
  - YBR\_ICT, [808](#)
  - YBR\_PARTIAL\_420, [808](#)
  - YBR\_PARTIAL\_422, [808](#)
  - YBR\_RCT, [808](#)
- gdcM::PixelFormat, [810](#)
  - Bitmap, [818](#)
  - FLOAT16, [812](#)
  - FLOAT32, [812](#)
  - FLOAT64, [812](#)
  - GetBitsAllocated, [813](#)
  - GetBitsStored, [813](#)
  - GetHighBit, [814](#)
  - GetMax, [814](#)
  - GetMin, [814](#)
  - GetPixelRepresentation, [814](#)
  - GetPixelSize, [814](#)
  - GetSamplesPerPixel, [815](#)
  - GetScalarType, [815](#)
  - GetScalarTypeAsString, [815](#)
  - INT12, [812](#)
  - INT16, [812](#)
  - INT32, [812](#)
  - INT64, [812](#)
  - INT8, [812](#)
  - IsCompatible, [815](#)
  - IsValid, [816](#)
  - operator ScalarType, [816](#)
  - operator!=, [816](#)
  - operator<<, [818](#)
  - operator==, [816](#)
  - PixelFormat, [813](#)
  - Print, [817](#)
  - ScalarType, [812](#)
  - SetBitsAllocated, [817](#)
  - SetBitsStored, [817](#)
  - SetHighBit, [817](#)
  - SetPixelRepresentation, [817](#)
  - SetSamplesPerPixel, [817](#)
  - SetScalarType, [818](#)
  - SINGLEBIT, [812](#)
  - UINT12, [812](#)



- UINT16, [812](#)
- UINT32, [812](#)
- UINT64, [812](#)
- UINT8, [812](#)
- UNKNOWN, [812](#)
- Validate, [818](#)
- gdcmm::Pixmap, [819](#)
  - ~Pixmap, [821](#)
  - AreOverlaysInPixelData, [821](#)
  - Curves, [824](#)
  - GetCurve, [821](#), [822](#)
  - GetIconImage, [822](#)
  - GetNumberOfCurves, [822](#)
  - GetNumberOfOverlays, [822](#)
  - GetOverlay, [822](#), [823](#)
  - Icon, [824](#)
  - Overlays, [824](#)
  - Pixmap, [821](#)
  - Print, [823](#)
  - RemoveOverlay, [823](#)
  - SetIconImage, [823](#)
  - SetNumberOfCurves, [823](#)
  - SetNumberOfOverlays, [823](#)
  - UnusedBitsPresentInPixelData, [824](#)
- gdcmm::PixmapReader, [825](#)
  - ~PixmapReader, [827](#)
  - GetPixmap, [827](#)
  - PixelData, [829](#)
  - PixmapReader, [827](#)
  - Read, [828](#)
  - ReadACRNEMAIImage, [828](#)
  - ReadImage, [828](#)
  - ReadImageInternal, [828](#)
- gdcmm::PixmapToPixmapFilter, [829](#)
  - ~PixmapToPixmapFilter, [831](#)
  - GetInput, [831](#)
  - GetOutput, [831](#)
  - GetOutputAsPixmap, [831](#)
  - PixmapToPixmapFilter, [831](#)
- gdcmm::PixmapWriter, [832](#)
  - ~PixmapWriter, [834](#)
  - DolconImage, [834](#)
  - GetImage, [835](#)
  - GetPixmap, [835](#)
  - PixelData, [836](#)
  - PixmapWriter, [834](#)
  - PrepareWrite, [835](#)
  - SetImage, [835](#)
  - SetPixmap, [836](#)
  - Write, [836](#)
- gdcmm::PNMCodec, [837](#)
  - ~PNMCodec, [838](#)
  - CanCode, [838](#)
  - CanDecode, [839](#)
  - Clone, [839](#)
  - GetBufferLength, [839](#)
  - GetHeaderInfo, [839](#)
  - PNMCodec, [838](#)
  - Read, [839](#)
  - SetBufferLength, [840](#)
  - Write, [840](#)
- gdcmm::Preamble, [840](#)
  - ~Preamble, [842](#)
  - Clear, [842](#)
  - Create, [842](#)
  - GetInternal, [842](#)
  - GetLength, [842](#)
  - IsEmpty, [843](#)
  - IsValid, [843](#)
  - operator<<, [844](#)
  - operator=, [843](#)
  - Preamble, [841](#), [842](#)
  - Print, [843](#)
  - Read, [843](#)
  - Remove, [843](#)
  - Valid, [844](#)
  - Write, [844](#)
- gdcmm::PresentationContext, [845](#)
  - AbstractSyntax, [848](#)
  - AddTransferSyntax, [847](#)
  - GetAbstractSyntax, [847](#)
  - GetNumberOfTransferSyntaxes, [847](#)
  - GetPresentationContextID, [847](#)
  - GetTransferSyntax, [847](#)
  - ID, [848](#)
  - operator==, [847](#)
  - PresentationContext, [846](#)
  - Print, [848](#)
  - SetAbstractSyntax, [848](#)
  - SetPresentationContextID, [848](#)
  - SizeType, [846](#)
  - TransferSyntaxArrayType, [846](#)
  - TransferSyntaxes, [848](#)
- gdcmm::PresentationContextGenerator, [851](#)
  - AddFromFile, [853](#)
  - AddPresentationContext, [853](#)
  - GenerateFromFileNames, [853](#)
  - GenerateFromUID, [854](#)
  - GetDefaultTransferSyntax, [854](#)
  - GetPresentationContexts, [854](#)
  - PresentationContextArrayType, [853](#)
  - PresentationContextGenerator, [853](#)
  - SetDefaultTransferSyntax, [854](#)
  - SetMergeModeToAbstractSyntax, [854](#)
  - SetMergeModeToTransferSyntax, [855](#)
  - SizeType, [853](#)
- gdcmm::Printer, [863](#)
  - ~Printer, [865](#)

- CONDENSED\_STYLE, 865
- CXX, 865
- F, 868
- GetPrintStyle, 866
- MaxPrintLength, 868
- Print, 866
- PrintDataElement, 866
- PrintDataSet, 866
- Printer, 865
- PrintSQ, 867
- PrintStyle, 868
- PrintStyles, 865
- SetColor, 867
- SetFile, 867
- SetStyle, 867
- VERBOSE\_STYLE, 865
- XML, 865
- gdcM::PrivateDict, 868
  - ~PrivateDict, 869
  - AddDictEntry, 869
  - Dicts, 871
  - FindDictEntry, 869
  - GetDictEntry, 870
  - IsEmpty, 870
  - LoadDefault, 870
  - operator<<, 871
  - PrintXML, 870
  - PrivateDict, 869
  - RemoveDictEntry, 870
- gdcM::PrivateTag, 871
  - GetAsDataElement, 873
  - GetOwner, 873
  - operator<, 873
  - operator<<, 874
  - PrivateTag, 872, 873
  - ReadFromCommaSeparatedString, 873
  - SetOwner, 874
- gdcM::ProgressEvent, 874
  - ~ProgressEvent, 876
  - CheckEvent, 876
  - GetEventName, 877
  - GetProgress, 877
  - MakeObject, 877
  - operator=, 877
  - ProgressEvent, 876
  - Self, 876
  - SetProgress, 877
  - Superclass, 876
- gdcM::PVRGCodec, 878
  - ~PVRGCodec, 879
  - CanCode, 879
  - CanDecode, 880
  - Clone, 880
  - Code, 880
  - Decode, 880
  - PVRGCodec, 879
  - SetLossyFlag, 881
- gdcM::PythonFilter, 881
  - ~PythonFilter, 882
  - GetFile, 882
  - PythonFilter, 882
  - SetDicts, 882
  - SetFile, 882
  - ToPyObject, 882
  - UseDictAlways, 883
- gdcM::QueryBase, 883
  - ~QueryBase, 884
  - GetAllRequiredTags, 884
  - GetAllTags, 884
  - GetHierarchicalSearchTags, 885
  - GetName, 885
  - GetOptionalTags, 885
  - GetQueryLevel, 885
  - GetRequiredTags, 885
  - GetUniqueTags, 886
- gdcM::QueryFactory, 886
  - GetCharacterFromCurrentLocale, 887
  - ListCharSets, 887
  - ProduceCharacterSetDataElement, 887
  - ProduceQuery, 887
- gdcM::QueryImage, 888
  - GetHierarchicalSearchTags, 889
  - GetName, 889
  - GetOptionalTags, 889
  - GetQueryLevel, 889
  - GetRequiredTags, 890
  - GetUniqueTags, 890
- gdcM::QueryPatient, 890
  - GetHierarchicalSearchTags, 891
  - GetName, 891
  - GetOptionalTags, 892
  - GetQueryLevel, 892
  - GetRequiredTags, 892
  - GetUniqueTags, 892
- gdcM::QuerySeries, 893
  - GetHierarchicalSearchTags, 894
  - GetName, 894
  - GetOptionalTags, 894
  - GetQueryLevel, 894
  - GetRequiredTags, 894
  - GetUniqueTags, 895
- gdcM::QueryStudy, 895
  - GetHierarchicalSearchTags, 896
  - GetName, 896
  - GetOptionalTags, 897
  - GetQueryLevel, 897
  - GetRequiredTags, 897
  - GetUniqueTags, 897

- gdcmm::RAWCodec, 898
  - ~RAWCodec, 899
  - CanCode, 899
  - CanDecode, 900
  - Clone, 900
  - Code, 900
  - Decode, 900
  - DecodeByStreams, 901
  - DecodeBytes, 901
  - GetHeaderInfo, 901
  - RAWCodec, 899
- gdcmm::Reader, 902
  - ~Reader, 905
  - CanRead, 905
  - F, 909
  - GetFile, 905
  - GetStreamCurrentPosition, 906
  - GetStreamPtr, 906
  - Read, 906
  - ReadDataSet, 906
  - Reader, 905
  - ReadMetaInformation, 907
  - ReadPreamble, 907
  - ReadSelectedPrivateTags, 907
  - ReadSelectedTags, 907
  - ReadUpToTag, 907
  - SetFile, 908
  - SetFileName, 908
  - SetStream, 908
  - StreamImageReader, 909
- gdcmm::RealWorldValueMappingContent, 910
  - CodeMeaning, 910
  - CodeValue, 910
  - RealWorldValueIntercept, 911
  - RealWorldValueSlope, 911
- gdcmm::Region, 911
  - ~Region, 912
  - Area, 912
  - Clone, 913
  - ComputeBoundingBox, 913
  - Empty, 913
  - IsValid, 913
  - Print, 913
  - Region, 912
- gdcmm::Rescaler, 914
  - ~Rescaler, 916
  - ComputeInterceptSlopePixelFormat, 916
  - ComputePixelFormatFromMinMax, 916
  - GetIntercept, 916
  - GetSlope, 916
  - InverseRescale, 916
  - InverseRescaleFunctionIntoBestFit, 917
  - Rescale, 917
  - RescaleFunctionIntoBestFit, 917
  - Rescaler, 915
  - SetIntercept, 917
  - SetMinMaxForPixelFormat, 917
  - SetPixelFormat, 918
  - SetSlope, 918
  - SetTargetPixelFormat, 918
  - SetUseTargetPixelFormat, 918
- gdcmm::RLECodec, 919
  - ~RLECodec, 921
  - AppendFrameEncode, 921
  - AppendRowEncode, 921
  - CanCode, 921
  - CanDecode, 921
  - Clone, 922
  - Code, 922
  - Decode, 922
  - DecodeByStreams, 922
  - DecodeExtent, 923
  - GetBufferLength, 923
  - GetHeaderInfo, 923
  - ImageRegionReader, 924
  - IsFrameEncoder, 923
  - IsRowEncoder, 923
  - RLECodec, 920
  - SetBufferLength, 924
  - SetLength, 924
  - StartEncode, 924
  - StopEncode, 924
- gdcmm::Scanner, 927
  - ~Scanner, 930
  - AddPrivateTag, 930
  - AddSkipTag, 931
  - AddTag, 931
  - Begin, 931
  - ClearSkipTags, 931
  - ClearTags, 931
  - ConstIterator, 929
  - End, 931
  - GetAllFileNamesFromTagToValue, 932
  - GetFilenameFromTagToValue, 932
  - GetFileNames, 932
  - GetKeys, 932
  - GetMapping, 932
  - GetMappingFromTagToValue, 933
  - GetMapping, 933
  - GetOrderedValues, 933
  - GetValue, 933
  - GetValues, 933, 934
  - IsKey, 934
  - MappingType, 929
  - New, 934
  - operator<<, 935
  - Print, 934
  - PrintTable, 935

ProcessPublicTag, [935](#)  
 Scan, [935](#)  
 Scanner, [930](#)  
 TagToValue, [930](#)  
 TagToValueValueType, [930](#)  
 ValuesType, [930](#)  
 gdcmm::Scanner::ltstr, [666](#)  
   operator(), [666](#)  
 gdcmm::Segment, [936](#)  
   ~Segment, [939](#)  
   AddSurface, [939](#)  
   ALGOType, [938](#)  
   ALGOType\_END, [939](#)  
   AnatomicRegion, [944](#)  
   AnatomicRegionModifiers, [944](#)  
   AUTOMATIC, [939](#)  
   BasicCodedEntryVector, [938](#)  
   GetALGOType, [939](#)  
   GetALGOTypeString, [939](#)  
   GetAnatomicRegion, [940](#)  
   GetAnatomicRegionModifiers, [940](#)  
   GetPropertyCategory, [940](#)  
   GetPropertyType, [940](#), [941](#)  
   GetPropertyTypeModifiers, [941](#)  
   GetSegmentAlgorithmName, [941](#)  
   GetSegmentAlgorithmType, [941](#)  
   GetSegmentDescription, [941](#)  
   GetSegmentLabel, [941](#)  
   GetSegmentNumber, [942](#)  
   GetSurface, [942](#)  
   GetSurfaceCount, [942](#)  
   GetSurfaces, [942](#)  
   MANUAL, [939](#)  
   PropertyCategory, [945](#)  
   PropertyType, [945](#)  
   PropertyTypeModifiers, [945](#)  
   Segment, [939](#)  
   SegmentAlgorithmName, [945](#)  
   SegmentAlgorithmType, [945](#)  
   SegmentDescription, [945](#)  
   SegmentLabel, [945](#)  
   SegmentNumber, [946](#)  
   SEMIAUTOMATIC, [939](#)  
   SetAnatomicRegion, [942](#)  
   SetAnatomicRegionModifiers, [942](#)  
   SetPropertyCategory, [943](#)  
   SetPropertyType, [943](#)  
   SetPropertyTypeModifiers, [943](#)  
   SetSegmentAlgorithmName, [943](#)  
   SetSegmentAlgorithmType, [943](#)  
   SetSegmentDescription, [944](#)  
   SetSegmentLabel, [944](#)  
   SetSegmentNumber, [944](#)  
   SetSurfaceCount, [944](#)  
   SurfaceCount, [946](#)  
   Surfaces, [946](#)  
   SurfaceVector, [938](#)  
 gdcmm::SegmentedPaletteColorLookupTable, [946](#)  
   ~SegmentedPaletteColorLookupTable, [947](#)  
   Print, [948](#)  
   SegmentedPaletteColorLookupTable, [947](#)  
   SetLUT, [948](#)  
 gdcmm::SegmentHelper, [84](#)  
 gdcmm::SegmentHelper::BasicCodedEntry, [188](#)  
   BasicCodedEntry, [189](#)  
   CM, [190](#)  
   CSD, [190](#)  
   CSV, [190](#)  
   CV, [191](#)  
   IsEmpty, [190](#)  
 gdcmm::SegmentReader, [949](#)  
   ~SegmentReader, [951](#)  
   GetSegments, [951](#)  
   Read, [951](#)  
   ReadSegment, [952](#)  
   ReadSegments, [952](#)  
   SegmentMap, [950](#)  
   SegmentReader, [951](#)  
   Segments, [952](#)  
   SegmentVector, [951](#)  
 gdcmm::SegmentWriter, [953](#)  
   ~SegmentWriter, [954](#)  
   AddSegment, [955](#)  
   GetNumberOfSegments, [955](#)  
   GetSegment, [955](#)  
   GetSegments, [955](#)  
   PrepareWrite, [955](#)  
   Segments, [956](#)  
   SegmentVector, [954](#)  
   SegmentWriter, [954](#)  
   SetNumberOfSegments, [955](#)  
   SetSegments, [956](#)  
   Write, [956](#)  
 gdcmm::SequenceOfFragments, [957](#)  
   AddFragment, [959](#)  
   Begin, [960](#)  
   Clear, [960](#)  
   ComputeByteLength, [960](#)  
   ComputeLength, [960](#)  
   ConstIterator, [959](#)  
   End, [960](#), [961](#)  
   FragmentVector, [959](#)  
   GetBuffer, [961](#)  
   GetFragBuffer, [961](#)  
   GetFragment, [961](#)  
   GetLength, [961](#)  
   GetNumberOfFragments, [962](#)  
   GetTable, [962](#)

- Iterator, [959](#)
- New, [962](#)
- operator==, [962](#)
- Print, [962](#)
- Read, [963](#)
- ReadPreValue, [963](#)
- ReadValue, [963](#)
- SequenceOfFragments, [959](#)
- SetLength, [963](#)
- SizeType, [959](#)
- Write, [963](#)
- WriteBuffer, [964](#)
- gdcmm::SequenceOfItems, [964](#)
  - AddItem, [968](#)
  - AddNewUndefinedLengthItem, [968](#)
  - Begin, [968](#)
  - Clear, [968](#)
  - ComputeLength, [969](#)
  - ConstIterator, [967](#)
  - End, [969](#)
  - FindDataElement, [969](#)
  - GetItem, [969](#)
  - GetLength, [970](#)
  - GetNumberOfItems, [970](#)
  - IsEmpty, [970](#)
  - IsUndefinedLength, [970](#)
  - Items, [972](#)
  - ItemVector, [967](#)
  - Iterator, [967](#)
  - New, [970](#)
  - operator=, [971](#)
  - operator==, [971](#)
  - Print, [971](#)
  - Read, [971](#)
  - RemoveItemByIndex, [971](#)
  - SequenceLengthField, [973](#)
  - SequenceOfItems, [967](#)
  - SetLength, [972](#)
  - SetLengthToUndefined, [972](#)
  - SetNumberOfItems, [972](#)
  - SizeType, [967](#)
  - Write, [972](#)
- gdcmm::SerieHelper, [973](#)
  - ~SerieHelper, [975](#)
  - AddFile, [975](#)
  - AddFileName, [976](#)
  - AddRestriction, [976](#)
  - Clear, [976](#)
  - CreateDefaultUniqueSeriesIdentifier, [976](#)
  - CreateUniqueSeriesIdentifier, [977](#)
  - elem, [978](#)
  - FileNameOrdering, [977](#)
  - GetFirstSingleSerieUIDFileSet, [977](#)
  - GetNextSingleSerieUIDFileSet, [977](#)
  - ImageNumberOrdering, [977](#)
  - ImagePositionPatientOrdering, [977](#)
  - ItFileSetHt, [978](#)
  - op, [979](#)
  - OrderFileList, [977](#)
  - Rule, [975](#)
  - SerieHelper, [975](#)
  - SerieRestrictions, [975](#)
  - SetDirectory, [978](#)
  - SetLoadMode, [978](#)
  - SetUseSeriesDetails, [978](#)
  - SingleSerieUIDFileSetHT, [979](#)
  - SingleSerieUIDFileSetmap, [975](#)
  - UserOrdering, [978](#)
  - value, [979](#)
- gdcmm::Series, [979](#)
  - Series, [980](#)
- gdcmm::ServiceClassUser, [982](#)
  - ~ServiceClassUser, [984](#)
  - GetAETitle, [985](#)
  - GetCalledAETitle, [985](#)
  - GetTimeout, [985](#)
  - InitializeConnection, [985](#)
  - IsPresentationContextAccepted, [985](#)
  - New, [985](#)
  - operator=, [986](#)
  - SendEcho, [986](#)
  - SendFind, [986](#)
  - SendMove, [986, 987](#)
  - SendStore, [987](#)
  - ServiceClassUser, [984](#)
  - SetAETitle, [987](#)
  - SetCalledAETitle, [988](#)
  - SetHostname, [988](#)
  - SetPort, [988](#)
  - SetPortSCP, [988](#)
  - SetPresentationContexts, [989](#)
  - SetTimeout, [989](#)
  - StartAssociation, [989](#)
  - StopAssociation, [989](#)
- gdcmm::SHA1, [990](#)
  - ~SHA1, [991](#)
  - Compute, [991](#)
  - ComputeFile, [991](#)
  - operator=, [991](#)
  - SHA1, [991](#)
- gdcmm::SimpleMemberCommand< T >, [992](#)
  - ~SimpleMemberCommand, [995](#)
  - Execute, [995](#)
  - m\_MemberFunction, [996](#)
  - m\_This, [996](#)
  - New, [995](#)
  - operator=, [996](#)
  - Self, [994](#)

- SetCallbackFunction, 996
- SimpleMemberCommand, 994
- TMemberFunctionPointer, 994
- gdcM::SimpleSubjectWatcher, 997
  - ~SimpleSubjectWatcher, 998
  - EndFilter, 998
  - operator=, 998
  - ShowAbort, 998
  - ShowAnonymization, 999
  - ShowData, 999
  - ShowDataSet, 999
  - ShowFileName, 999
  - ShowIteration, 999
  - ShowProgress, 1000
  - SimpleSubjectWatcher, 998
  - StartFilter, 1000
  - TestAbortOff, 1000
  - TestAbortOn, 1000
- gdcM::SmartPointer< ObjectType >, 1003
  - ~SmartPointer, 1005
  - GetPointer, 1005
  - operator ObjectType \*, 1006
  - operator\*, 1006
  - operator->, 1006
  - operator=, 1006, 1007
  - SmartPointer, 1004, 1005
- gdcM::SOPClassUIDToIOD, 1009
  - const, 1009
  - GetIOD, 1010
  - GetIODFromSOPClassUID, 1010
  - GetNumberOfSOPClassToIOD, 1010
  - GetSOPClassUIDFromIOD, 1010
  - GetSOPClassUIDToIOD, 1010
  - GetSOPClassUIDToIODs, 1010
- gdcM::Sorter, 1011
  - ~Sorter, 1013
  - AddSelect, 1013
  - FileNames, 1015
  - GetFileNames, 1013
  - operator<<, 1015
  - Print, 1014
  - Selection, 1015
  - SelectionMap, 1013
  - SetSortFunction, 1014
  - SetTagsToRead, 1014
  - Sort, 1014
  - Sorter, 1013
  - SortFunc, 1016
  - SortFunction, 1013
  - StableSort, 1015
  - TagsToRead, 1016
- gdcM::Spacing, 1016
  - ~Spacing, 1018
  - CALIBRATED, 1018
  - ComputePixelAspectRatioFromPixelSpacing, 1018
  - DETECTOR, 1018
  - MAGNIFIED, 1018
  - Spacing, 1018
  - SpacingType, 1017
  - UNKNOWN, 1018
- gdcM::Spectroscopy, 1018
  - Spectroscopy, 1019
- gdcM::SplitMosaicFilter, 1019
  - ~SplitMosaicFilter, 1020
  - ComputeMOSAICDimensions, 1020
  - ComputeMOSAICSliceNormal, 1020
  - ComputeMOSAICSlicePosition, 1021
  - GetAcquisitionSize, 1021
  - GetFile, 1021
  - GetImage, 1021
  - GetNumberOfImagesInMosaic, 1022
  - SetFile, 1022
  - SetImage, 1022
  - Split, 1022
  - SplitMosaicFilter, 1020
- gdcM::StartEvent, 1023
- gdcM::static\_assert\_test< x >, 1024
- gdcM::STATIC\_ASSERTION\_FAILURE< true >, 1024
  - value, 1024
- gdcM::STATIC\_ASSERTION\_FAILURE< x >, 1024
- gdcM::StreamImageReader, 1025
  - ~StreamImageReader, 1026
  - CanReadImage, 1026
  - DefinePixelExtent, 1026
  - DefineProperBufferLength, 1026
  - GetDimensionsValueForResolution, 1027
  - GetFile, 1027
  - Read, 1027
  - ReadImageInformation, 1027
  - SetFileName, 1028
  - SetStream, 1028
  - StreamImageReader, 1025
- gdcM::StreamImageWriter, 1029
  - ~StreamImageWriter, 1031
  - CanWriteFile, 1031
  - DefinePixelExtent, 1031
  - DefineProperBufferLength, 1031
  - mElementOffsets, 1034
  - mElementOffsets1, 1034
  - mSPFile, 1034
  - mWriter, 1034
  - mXMax, 1034
  - mXMin, 1035
  - mYMax, 1035
  - mYMin, 1035
  - mZMax, 1035
  - mZMin, 1035
  - SetFile, 1032

- SetFileName, [1032](#)
- SetStream, [1032](#)
- StreamImageWriter, [1031](#)
- Write, [1032](#)
- WriteImageInformation, [1033](#)
- WriteImageSubregionRAW, [1033](#)
- WriteRawHeader, [1033](#)
- gdcmm::StrictScanner, [1036](#)
  - ~StrictScanner, [1039](#)
  - AddPrivateTag, [1039](#)
  - AddSkipTag, [1040](#)
  - AddTag, [1040](#)
  - Begin, [1040](#)
  - ClearSkipTags, [1040](#)
  - ClearTags, [1040](#)
  - ConstIterator, [1038](#)
  - End, [1040](#)
  - GetAllFilenamesFromTagToValue, [1041](#)
  - GetFilenameFromTagToValue, [1041](#)
  - GetFilenames, [1041](#)
  - GetKeys, [1041](#)
  - GetMapping, [1041](#)
  - GetMappingFromTagToValue, [1041](#)
  - GetMappings, [1042](#)
  - GetOrderedValues, [1042](#)
  - GetValue, [1042](#)
  - GetValues, [1042](#)
  - IsKey, [1043](#)
  - MappingType, [1038](#)
  - New, [1043](#)
  - operator<<, [1044](#)
  - Print, [1043](#)
  - PrintTable, [1043](#)
  - ProcessPublicTag, [1043](#)
  - Scan, [1044](#)
  - StrictScanner, [1039](#)
  - TagToValue, [1039](#)
  - TagToValueValueType, [1039](#)
  - ValueType, [1039](#)
- gdcmm::StrictScanner::Itstr, [667](#)
  - operator(), [667](#)
- gdcmm::String< TDelimiter, TMaxLength, TPadChar >, [1045](#)
  - const\_iterator, [1047](#)
  - const\_reference, [1047](#)
  - const\_reverse\_iterator, [1047](#)
  - difference\_type, [1047](#)
  - IsValid, [1049](#)
  - iterator, [1047](#)
  - operator const char \*, [1049](#)
  - pointer, [1047](#)
  - reference, [1048](#)
  - reverse\_iterator, [1048](#)
  - size\_type, [1048](#)
  - String, [1048](#), [1049](#)
  - Trim, [1049](#), [1050](#)
  - Truncate, [1050](#)
  - value\_type, [1048](#)
- gdcmm::StringFilter, [1050](#)
  - ~StringFilter, [1051](#)
  - ExecuteQuery, [1052](#)
  - FromString, [1052](#)
  - GetFile, [1052](#)
  - SetDicts, [1053](#)
  - SetFile, [1053](#)
  - StringFilter, [1051](#)
  - ToString, [1053](#)
  - ToStringPair, [1054](#)
  - UseDictAlways, [1054](#)
- gdcmm::Study, [1055](#)
  - Study, [1055](#)
- gdcmm::Subject, [1055](#)
  - ~Subject, [1057](#)
  - AddObserver, [1057](#)
  - GetCommand, [1058](#)
  - HasObserver, [1058](#)
  - InvokeEvent, [1058](#)
  - RemoveAllObservers, [1058](#)
  - RemoveObserver, [1058](#)
  - Subject, [1057](#)
- gdcmm::Surface, [1059](#)
  - ~Surface, [1062](#)
  - GetAlgorithmFamily, [1063](#)
  - GetAlgorithmName, [1063](#)
  - GetAlgorithmVersion, [1063](#)
  - GetAxisOfRotation, [1063](#)
  - GetCenterOfRotation, [1063](#)
  - GetFiniteVolume, [1064](#)
  - GetManifold, [1064](#)
  - GetMaximumPointDistance, [1064](#)
  - GetMeanPointDistance, [1064](#)
  - GetMeshPrimitive, [1064](#)
  - GetNumberOfSurfacePoints, [1065](#)
  - GetNumberOfVectors, [1065](#)
  - GetPointCoordinatesData, [1065](#)
  - GetPointPositionAccuracy, [1065](#)
  - GetPointsBoundingBoxCoordinates, [1065](#)
  - GetProcessingAlgorithm, [1066](#)
  - GetRecommendedDisplayCIELabValue, [1066](#)
  - GetRecommendedDisplayGrayscaleValue, [1066](#)
  - GetRecommendedPresentationOpacity, [1066](#)
  - GetRecommendedPresentationType, [1067](#)
  - GetSTATES, [1067](#)
  - GetSTATESString, [1067](#)
  - GetSurfaceComments, [1067](#)
  - GetSurfaceNumber, [1067](#)
  - GetSurfaceProcessing, [1067](#)
  - GetSurfaceProcessingDescription, [1067](#)



- GetSurfaceProcessingRatio, 1068
- GetVectorAccuracy, 1068
- GetVectorCoordinateData, 1068
- GetVectorDimensionality, 1068
- GetVIEWType, 1068
- GetVIEWTypeString, 1068
- NO, 1062
- POINTS, 1062
- SetAlgorithmFamily, 1069
- SetAlgorithmName, 1069
- SetAlgorithmVersion, 1069
- SetAxisOfRotation, 1069
- SetCenterOfRotation, 1069
- SetFiniteVolume, 1069
- SetManifold, 1070
- SetMaximumPointDistance, 1070
- SetMeanPointDistance, 1070
- SetMeshPrimitive, 1070
- SetNumberOfSurfacePoints, 1070
- SetNumberOfVectors, 1070
- SetPointCoordinatesData, 1071
- SetPointPositionAccuracy, 1071
- SetPointsBoundingBoxCoordinates, 1071
- SetProcessingAlgorithm, 1071
- SetRecommendedDisplayCIELabValue, 1071, 1072
- SetRecommendedDisplayGrayscaleValue, 1072
- SetRecommendedPresentationOpacity, 1072
- SetRecommendedPresentationType, 1072
- SetSurfaceComments, 1072
- SetSurfaceNumber, 1072
- SetSurfaceProcessing, 1073
- SetSurfaceProcessingDescription, 1073
- SetSurfaceProcessingRatio, 1073
- SetVectorAccuracy, 1073
- SetVectorCoordinateData, 1073
- SetVectorDimensionality, 1073
- STATES, 1062
- STATES\_END, 1062
- SURFACE, 1062
- Surface, 1062
- UNKNOWN, 1062
- VIEWType, 1062
- VIEWType\_END, 1062
- WIREFRAME, 1062
- YES, 1062
- gdcmm::SurfaceHelper, 1074
  - ColorArray, 1075
  - RecommendedDisplayCIELabToRGB, 1075
  - RGBToRecommendedDisplayCIELab, 1076
  - RGBToRecommendedDisplayGrayscale, 1076
- gdcmm::SurfaceReader, 1077
  - ~SurfaceReader, 1079
  - GetNumberOfSurfaces, 1079
  - Read, 1080
  - ReadPointMacro, 1080
  - ReadSurface, 1080
  - ReadSurfaces, 1080
  - SurfaceReader, 1079
- gdcmm::SurfaceWriter, 1081
  - ~SurfaceWriter, 1082
  - ComputeNumberOfSurfaces, 1082
  - GetNumberOfSurfaces, 1082
  - NumberOfSurfaces, 1083
  - PrepareWrite, 1083
  - PrepareWritePointMacro, 1083
  - SetNumberOfSurfaces, 1083
  - SurfaceWriter, 1082
  - Write, 1083
- gdcmm::SwapCode, 1084
  - BadBigEndian, 1085
  - BadLittleEndian, 1085
  - BigEndian, 1085
  - GetIndex, 1085
  - GetSwapCodeString, 1085
  - LittleEndian, 1085
  - operator SwapCode::SwapCodeType, 1086
  - operator<<, 1086
  - SwapCode, 1085
  - SwapCodeType, 1085
  - Unknown, 1085
- gdcmm::SwapperDoOp, 1086
  - Swap, 1086
  - SwapArray, 1087
- gdcmm::SwapperNoOp, 1087
  - Swap, 1087
  - SwapArray, 1088
- gdcmm::System, 1088
  - ConvertToUNC, 1089
  - DeleteDirectory, 1089
  - EncodeBytes, 1090
  - FileExists, 1090
  - FileIsDirectory, 1090
  - FileIsSymlink, 1090
  - FileSize, 1091
  - FileTime, 1091
  - FormatDateTime, 1091
  - GetCurrentDateTime, 1091
  - GetCurrentModuleFileName, 1092
  - GetCurrentProcessFileName, 1092
  - GetCurrentResourcesDirectory, 1092
  - GetCWD, 1092
  - GetHostName, 1092
  - GetLastSystemError, 1092
  - GetLocaleCharset, 1093
  - GetPermissions, 1093
  - GetTimezoneOffsetFromUTC, 1093
  - MakeDirectory, 1093
  - ParseDateTime, 1093, 1094



- RemoveFile, [1094](#)
- SetPermissions, [1094](#)
- StrCaseCmp, [1094](#)
- StrNCaseCmp, [1095](#)
- StrSep, [1095](#)
- StrTokR, [1095](#)
- gdcM::Table, [1096](#)
  - ~Table, [1097](#)
  - GetTableEntry, [1097](#)
  - InsertEntry, [1098](#)
  - MapTableEntry, [1097](#)
  - operator<<, [1098](#)
  - operator=, [1098](#)
  - Table, [1097](#)
  - TableInternal, [1098](#)
- gdcM::TableEntry, [1099](#)
  - ~TableEntry, [1099](#)
  - TableEntry, [1099](#)
- gdcM::TableReader, [1100](#)
  - ~TableReader, [1101](#)
  - CharacterDataHandler, [1101](#)
  - EndElement, [1101](#)
  - GetDefs, [1101](#)
  - GetFilename, [1101](#)
  - HandleIOD, [1102](#)
  - HandleIODEntry, [1102](#)
  - HandleMacro, [1102](#)
  - HandleMacroEntry, [1102](#)
  - HandleMacroEntryDescription, [1102](#)
  - HandleModule, [1102](#)
  - HandleModuleEntry, [1103](#)
  - HandleModuleEntryDescription, [1103](#)
  - HandleModuleInclude, [1103](#)
  - Read, [1103](#)
  - SetFilename, [1103](#)
  - StartElement, [1103](#)
  - TableReader, [1101](#)
- gdcM::Tag, [1105](#)
  - bytes, [1116](#)
  - GetElement, [1108](#)
  - GetElementTag, [1108](#)
  - GetGroup, [1109](#)
  - GetLength, [1109](#)
  - GetPrivateCreator, [1109](#)
  - IsGroupLength, [1109](#)
  - IsGroupXX, [1109](#)
  - IsIllegal, [1110](#)
  - IsPrivate, [1110](#)
  - IsPrivateCreator, [1110](#)
  - IsPublic, [1110](#)
  - operator!=, [1111](#)
  - operator<, [1111](#)
  - operator<<, [1115](#)
  - operator<=, [1111](#)
  - operator>>, [1115](#)
  - operator=, [1111](#)
  - operator==, [1111](#)
  - operator[], [1112](#)
  - PrintAsContinuousString, [1112](#)
  - PrintAsContinuousUpperCaseString, [1112](#)
  - PrintAsPipeSeparatedString, [1112](#)
  - Read, [1113](#)
  - ReadFromCommaSeparatedString, [1113](#)
  - ReadFromContinuousString, [1113](#)
  - ReadFromPipeSeparatedString, [1113](#)
  - SetElement, [1113](#)
  - SetElementTag, [1114](#)
  - SetGroup, [1114](#)
  - SetPrivateCreator, [1114](#)
  - Tag, [1107](#), [1108](#)
  - tag, [1116](#)
  - tags, [1116](#)
  - Write, [1115](#)
- gdcM::TagPath, [1116](#)
  - ~TagPath, [1117](#)
  - ConstructFromString, [1117](#)
  - ConstructFromTagList, [1117](#)
  - IsValid, [1118](#)
  - Print, [1118](#)
  - Push, [1118](#)
  - TagPath, [1117](#)
- gdcM::terminal, [84](#)
  - Attribute, [85](#)
  - black, [85](#)
  - blink, [85](#)
  - blue, [85](#)
  - bright, [85](#)
  - Color, [85](#)
  - CONSOLE, [86](#)
  - cyan, [85](#)
  - dim, [85](#)
  - green, [85](#)
  - hidden, [85](#)
  - magenta, [85](#)
  - Mode, [86](#)
  - red, [85](#)
  - reset, [85](#)
  - reverse, [85](#)
  - setAttribute, [86](#)
  - setbgcolor, [86](#)
  - setfgcolor, [86](#)
  - setmode, [86](#)
  - underline, [85](#)
  - VT100, [86](#)
  - white, [85](#)
  - yellow, [85](#)
- gdcM::Testing, [1119](#)
  - ~Testing, [1120](#)

- ComputeFileMD5, 1121
- ComputeMD5, 1121
- GetDataExtraRoot, 1121
- GetDataRoot, 1121
- GetFileName, 1122
- GetFileNames, 1122
- GetLossyFlagFromFile, 1122
- GetMD5DataImage, 1122
- GetMD5DataImages, 1123
- GetMD5FromBrokenFile, 1123
- GetMD5FromFile, 1123
- GetMediaStorageDataFile, 1123
- GetMediaStorageDataFiles, 1123
- GetMediaStorageFromFile, 1123
- GetNumberOfFileNames, 1124
- GetNumberOfMD5DataImages, 1124
- GetNumberOfMediaStorageDataFiles, 1124
- GetPixelSpacingDataRoot, 1124
- GetSelectedPrivateGroupOffsetFromFile, 1124
- GetSelectedTagsOffsetFromFile, 1125
- GetSourceDirectory, 1125
- GetStreamOffsetFromFile, 1125
- GetTempDirectory, 1125
- GetTempDirectoryW, 1125
- GetTempFilename, 1126
- GetTempFilenameW, 1126
- MD5DataImagesType, 1120
- MediaStorageDataFilesType, 1120
- Print, 1126
- Testing, 1120
- gdcmm::Trace, 1127
- ~Trace, 1128
- DebugOff, 1128
- DebugOn, 1128
- ErrorOff, 1129
- ErrorOn, 1129
- GetDebugFlag, 1129
- GetDebugStream, 1129
- GetErrorFlag, 1129
- GetErrorStream, 1129
- GetStream, 1130
- GetWarningFlag, 1130
- GetWarningStream, 1130
- SetDebug, 1130
- SetDebugStream, 1130
- SetError, 1130
- SetErrorStream, 1131
- SetStream, 1131
- SetStreamToFile, 1131
- SetWarning, 1131
- SetWarningStream, 1131
- Trace, 1128
- WarningOff, 1132
- WarningOn, 1132
- gdcmm::TransferSyntax, 1132
- CanStoreLossy, 1136
- CT\_private\_ELE, 1135
- DeflatedExplicitVRLittleEndian, 1135
- Explicit, 1134
- ExplicitVRBigEndian, 1135
- ExplicitVRLittleEndian, 1135
- GetNegociatedType, 1136
- GetString, 1136
- GetSwapCode, 1136
- GetTString, 1136
- GetTSType, 1137
- Implicit, 1134
- ImplicitVRBigEndianACRNEMA, 1135
- ImplicitVRBigEndianPrivateGE, 1135
- ImplicitVRLittleEndian, 1135
- IsEncapsulated, 1137
- IsEncoded, 1137
- IsExplicit, 1137
- IsImplicit, 1137
- IsLossless, 1138
- IsLossy, 1138
- IsValid, 1138
- JPEG2000, 1135
- JPEG2000Lossless, 1135
- JPEG2000Part2, 1135
- JPEG2000Part2Lossless, 1135
- JPEGBaselineProcess1, 1135
- JPEGExtendedProcess2\_4, 1135
- JPEGExtendedProcess3\_5, 1135
- JPEGFullProgressionProcess10\_12, 1135
- JPEGLosslessProcess14, 1135
- JPEGLosslessProcess14\_1, 1135
- JPEGLSLossless, 1135
- JPEGLSNearLossless, 1135
- JPEGSpectralSelectionProcess6\_8, 1135
- JPIPReferenced, 1135
- MPEG2MainProfile, 1135
- MPEG2MainProfileHighLevel, 1135
- MPEG4AVCH264BDcompatibleHighProfileLevel4\_1, 1135
- MPEG4AVCH264HighProfileLevel4\_1, 1135
- NegociatedType, 1134
- operator TSType, 1138
- operator <<, 1138
- RLELossless, 1135
- TransferSyntax, 1135
- TS\_END, 1135
- TSType, 1135
- Unknown, 1134
- WeirdPapryus, 1135
- gdcmm::Type, 1143
- GetTypeString, 1145
- GetTypeType, 1145

- operator TypeType, 1145
- operator<<, 1145
- T1, 1144
- T1C, 1144
- T2, 1144
- T2C, 1144
- T3, 1144
- Type, 1144
- TypeType, 1144
- UNKNOWN, 1144
- gdcM::UI, 1146
  - Internal, 1146
  - operator<<, 1146
- gdcM::UIDGenerator, 1146
  - Generate, 1148
  - GenerateUUID, 1148
  - GetGDCMUID, 1148
  - GetRoot, 1148
  - IsValid, 1148
  - SetRoot, 1149
  - UIDGenerator, 1147
- gdcM::UIDs, 1149
  - AbstractMultiDimensionalImageModel, 1175
  - AcquisitionContextSRStorage, 1174
  - AdultMouseAnatomyOntology, 1172
  - AdvancedBlendingPresentationStateStorage, 1173
  - AmbulatoryECGWaveformStorage, 1169
  - ArterialPulseWaveformStorage, 1173
  - AudioSRStorageTrialRetired, 1170
  - AutorefrationMeasurementsStorage, 1173
  - BasicAnnotationBoxSOPClass, 1168
  - BasicColorImageBoxSOPClass, 1168
  - BasicColorPrintManagementMetaSOPClass, 1168
  - BasicFilmBoxSOPClass, 1168
  - BasicFilmSessionSOPClass, 1168
  - BasicGrayscaleImageBoxSOPClass, 1168
  - BasicGrayscalePrintManagementMetaSOPClass, 1168
  - BasicPrintImageOverlayBoxSOPClassRetired, 1168
  - BasicStructuredDisplayStorage, 1174
  - BasicStudyContentNotificationSOPClassRetired, 1167
  - BasicTextSRStorage, 1170
  - BasicVoiceAudioWaveformStorage, 1169
  - BlendingSoftcopyPresentationStateStorageSOPClass, 1169
  - BreastImagingRelevantPatientInformationQuery, 1171
  - BreastProjectionXRayImageStorageForPresentation, 1173
  - BreastProjectionXRayImageStorageForProcessing, 1173
  - BreastTomosynthesisImageStorage, 1172
  - CardiacElectrophysiologyWaveformStorage, 1169
  - CardiacRelevantPatientInformationQuery, 1171
  - ChestCADSRStorage, 1170
  - ColonCADSRStorage, 1174
  - ColorPaletteQueryRetrieveInformationModelFIND, 1175
  - ColorPaletteQueryRetrieveInformationModelGET, 1175
  - ColorPaletteQueryRetrieveInformationModelMOVE, 1175
  - ColorPaletteStorage, 1175
  - ColorSoftcopyPresentationStateStorageSOPClass, 1169
  - CompositeInstanceRetrieveWithoutBulkDataGET, 1174
  - CompositeInstanceRootRetrieveGET, 1174
  - CompositeInstanceRootRetrieveMOVE, 1174
  - CompositingPlanarMPRVolumetricPresentationStateStorage, 1173
  - Comprehensive3DSRStorage, 1174
  - ComprehensiveSRStorage, 1170
  - ComprehensiveSRStorageTrialRetired, 1170
  - ComputedRadiographyImageStorage, 1168
  - ContentAssessmentResultsStorage, 1174
  - CornealTopographyMapStorage, 1174
  - CTDefinedProcedureProtocolStorage, 1174
  - CTImageStorage, 1168
  - CTPerformedProcedureProtocolStorage, 1174
  - DefinedProcedureProtocolInformationModelFIND, 1174
  - DefinedProcedureProtocolInformationModelGET, 1174
  - DefinedProcedureProtocolInformationModelMOVE, 1174
  - DeflatedExplicitVRLittleEndian, 1166
  - DeformableSpatialRegistrationStorage, 1169
  - DetachedInterpretationManagementSOPClassRetired, 1168
  - DetachedPatientManagementMetaSOPClassRetired, 1167
  - DetachedPatientManagementSOPClassRetired, 1167
  - DetachedResultsManagementMetaSOPClassRetired, 1167
  - DetachedResultsManagementSOPClassRetired, 1167
  - DetachedStudyManagementMetaSOPClassRetired, 1167
  - DetachedStudyManagementSOPClassRetired, 1167
  - DetachedVisitManagementSOPClassRetired, 1167
  - DetailSRStorageTrialRetired, 1170
  - dicomAETitle, 1171
  - dicomApplicationCluster, 1171
  - DICOMApplicationContextName, 1167
  - dicomAssociationAcceptor, 1171

- dicomAssociationInitiator, [1171](#)
- dicomAuthorizedNodeCertificateReference, [1171](#)
- dicomConfigurationRoot, [1172](#)
- DICOMContentMappingResource, [1175](#)
- DICOMControlledTerminology, [1167](#)
- dicomDescription, [1171](#)
- dicomDevice, [1172](#)
- dicomDeviceName, [1171](#)
- dicomDeviceSerialNumber, [1172](#)
- dicomDevicesRoot, [1172](#)
- dicomHostname, [1171](#)
- dicomInstalled, [1171](#)
- dicomInstitutionAddress, [1172](#)
- dicomInstitutionDepartmentName, [1172](#)
- dicomInstitutionName, [1172](#)
- dicomIssuerOfPatientID, [1172](#)
- dicomManufacturer, [1171](#)
- dicomManufacturerModelName, [1171](#)
- dicomNetworkAE, [1172](#)
- dicomNetworkConnection, [1172](#)
- dicomNetworkConnectionReference, [1171](#)
- dicomPort, [1171](#)
- dicomPreferredCalledAETitle, [1171](#)
- dicomPreferredCallingAETitle, [1172](#)
- dicomPrimaryDeviceType, [1171](#)
- dicomRelatedDeviceReference, [1171](#)
- dicomSoftwareVersion, [1171](#)
- dicomSOPClass, [1171](#)
- dicomStationName, [1172](#)
- dicomSupportedCharacterSet, [1172](#)
- dicomThisNodeCertificateReference, [1171](#)
- dicomTLSCyphersuite, [1171](#)
- dicomTransferCapability, [1172](#)
- dicomTransferRole, [1171](#)
- dicomTransferSyntax, [1171](#)
- DICOMUIDRegistry, [1167](#)
- dicomUniqueAETitle, [1172](#)
- dicomUniqueAETitlesRegistryRoot, [1172](#)
- dicomVendorData, [1171](#)
- DICOS2DAITStorage, [1174](#)
- DICOS3DAITStorage, [1174](#)
- DICOSCTImageStorage, [1174](#)
- DICOSDigitalXRayImageStorageForPresentation, [1174](#)
- DICOSDigitalXRayImageStorageForProcessing, [1174](#)
- DICOSQuadrupoleResonanceQRStorage, [1174](#)
- DICOSThreatDetectionReportStorage, [1174](#)
- DigitalIntraoralXRayImageStorageForPresentation, [1168](#)
- DigitalIntraoralXRayImageStorageForProcessing, [1168](#)
- DigitalMammographyXRayImageStorageForPresentation, [1168](#)
- DigitalMammographyXRayImageStorageForProcessing, [1168](#)
- DigitalXRayImageStorageForPresentation, [1168](#)
- DigitalXRayImageStorageForProcessing, [1168](#)
- DisplaySystemSOPClass, [1173](#)
- DisplaySystemSOPInstance, [1173](#)
- ECG12leadWaveformStorage, [1169](#)
- EddyCurrentImageStorage, [1174](#)
- EddyCurrentMultiframeImageStorage, [1174](#)
- EncapsulatedCDASStorage, [1170](#)
- EncapsulatedPDFStorage, [1170](#)
- EncapsulatedSTLStorage, [1174](#)
- EnhancedCTImageStorage, [1168](#)
- EnhancedMRColorImageStorage, [1175](#)
- EnhancedMRIImageStorage, [1168](#)
- EnhancedPETImageStorage, [1174](#)
- EnhancedSRStorage, [1170](#)
- EnhancedUSVolumeStorage, [1172](#)
- EnhancedXAImageStorage, [1169](#)
- EnhancedXRFImageStorage, [1169](#)
- ExplicitVRBigEndian, [1166](#)
- ExplicitVRLittleEndian, [1166](#)
- ExtensibleSRStorage, [1174](#)
- FallColorPaletteSOPInstance, [1172](#)
- GeneralAudioWaveformStorage, [1173](#)
- GeneralECGWaveformStorage, [1169](#)
- GeneralPurposePerformedProcedureStepSOP-Class, [1171](#)
- GeneralPurposeScheduledProcedureStepSOP-Class, [1171](#)
- GeneralPurposeWorklistInformationModelFIND, [1170](#)
- GeneralPurposeWorklistManagementMetaSOP-Class, [1171](#)
- GeneralRelevantPatientInformationQuery, [1171](#)
- GenericImplantTemplateInformationModelFIND, [1175](#)
- GenericImplantTemplateInformationModelGET, [1175](#)
- GenericImplantTemplateInformationModelMOVE, [1175](#)
- GenericImplantTemplateStorage, [1175](#)
- GetName, [1185](#)
- GetNumberOfTransferSyntaxStrings, [1185](#)
- GetString, [1185](#)
- GetTransferSyntaxString, [1185](#)
- GetTransferSyntaxStrings, [1185](#)
- GetUIDName, [1186](#)
- GetUIDString, [1186](#)
- GrayscalePlanarMPRVolumetricPresentationStateStorage, [1173](#)
- GrayscaleSoftcopyPresentationStateStorageSOP-Class, [1169](#)
- HangingProtocolInformationModelFIND, [1171](#)
- HangingProtocolInformationModelGET, [1175](#)

- HangingProtocolInformationModelMOVE, [1171](#)  
 HangingProtocolStorage, [1171](#)  
 HardcopyColorImageStorageSOPClassRetired, [1168](#)  
 HardcopyGrayscaleImageStorageSOPClassRetired, [1168](#)  
 HemodynamicWaveformStorage, [1169](#)  
 HEVCH\_265Main10ProfileLevel5\_1, [1173](#)  
 HEVCH\_265MainProfileLevel5\_1, [1173](#)  
 HotIronColorPaletteSOPInstance, [1173](#)  
 HotMetalBlueColorPaletteSOPInstance, [1172](#)  
 ICBM452T1FrameofReference, [1167](#)  
 ICBMSingleSubjectMRIFrameofReference, [1167](#)  
 ICD11, [1172](#)  
 ImageBiomarkerStandardisationInitiative, [1172](#)  
 ImageOverlayBoxSOPClassRetired, [1168](#)  
 ImplantAssemblyTemplateInformationModelFIND, [1175](#)  
 ImplantAssemblyTemplateInformationModelGET, [1175](#)  
 ImplantAssemblyTemplateInformationModelMOVE, [1175](#)  
 ImplantAssemblyTemplateStorage, [1175](#)  
 ImplantationPlanSRStorage, [1174](#)  
 ImplantTemplateGroupInformationModelFIND, [1175](#)  
 ImplantTemplateGroupInformationModelGET, [1175](#)  
 ImplantTemplateGroupInformationModelMOVE, [1175](#)  
 ImplantTemplateGroupStorage, [1175](#)  
 ImplicitVRLittleEndianDefaultTransferSyntaxforDICOM, [1166](#)  
 InstanceAvailabilityNotificationSOPClass, [1171](#)  
 IntegratedTaxonomicInformationSystemITISTaxonomicSerialNumberTSN, [1172](#)  
 IntraocularLensCalculationsStorage, [1173](#)  
 IntravascularOpticalCoherenceTomographyImageStorageForPresentation, [1173](#)  
 IntravascularOpticalCoherenceTomographyImageStorageForProcessing, [1173](#)  
 JPEG2000ImageCompression, [1166](#)  
 JPEG2000ImageCompressionLosslessOnly, [1166](#)  
 JPEG2000Part2MulticomponentImageCompression, [1166](#)  
 JPEG2000Part2MulticomponentImageCompressionLosslessOnly,Class, [1167](#)  
 JPEGBaselineProcess1DefaultTransferSyntaxforLossyJPEG8BitImageCompression, [1166](#)  
 JPEGExtendedHierarchicalProcess1618Retired, [1166](#)  
 JPEGExtendedHierarchicalProcess1719Retired, [1166](#)  
 JPEGExtendedProcess24DefaultTransferSyntaxforLossyJPEG8BitImageCompression, [1166](#)  
 JPEGExtendedProcess35Retired, [1166](#)  
 JPEGFullProgressionHierarchicalProcess2426Retired, [1166](#)  
 JPEGFullProgressionHierarchicalProcess2527Retired, [1166](#)  
 JPEGFullProgressionNonHierarchicalProcess1012Retired, [1166](#)  
 JPEGFullProgressionNonHierarchicalProcess1113Retired, [1166](#)  
 JPEGLosslessHierarchicalProcess28Retired, [1166](#)  
 JPEGLosslessHierarchicalProcess29Retired, [1166](#)  
 JPEGLosslessNonHierarchicalFirstOrderPrediction-Process14SelectionValue1DefaultTransferSyntaxforLosslessJPEG8BitImageCompression, [1166](#)  
 JPEGLosslessNonHierarchicalProcess14, [1166](#)  
 JPEGLosslessNonHierarchicalProcess15Retired, [1166](#)  
 JPEGLSLosslessImageCompression, [1166](#)  
 JPEGLSLossyNearLosslessImageCompression, [1166](#)  
 JPEGSpectralSelectionHierarchicalProcess2022Retired, [1166](#)  
 JPEGSpectralSelectionHierarchicalProcess2123Retired, [1166](#)  
 JPEGSpectralSelectionNonHierarchicalProcess68Retired, [1166](#)  
 JPEGSpectralSelectionNonHierarchicalProcess79Retired, [1166](#)  
 JPIPReferenced, [1166](#)  
 JPIPReferencedDeflate, [1166](#)  
 KeratometryMeasurementsStorage, [1173](#)  
 KeyObjectSelectionDocumentStorage, [1170](#)  
 LegacyConvertedEnhancedCTImageStorage, [1172](#)  
 LegacyConvertedEnhancedMRIImageStorage, [1172](#)  
 LegacyConvertedEnhancedPETImageStorage, [1172](#)  
 LensometryMeasurementsStorage, [1173](#)  
 MacularGridThicknessandVolumeReportStorage, [1173](#)  
 MammographyCADSRStorage, [1170](#)  
 MayoClinicNonradiologicalImagesSBSAnatomical-SurfaceRegionGuide, [1172](#)  
 MediaCreationManagementSOPClassUID, [1168](#)  
 MediaStorageDirectoryStorage, [1167](#)  
 ModalityPerformedProcedureStepNotificationSOP-Class, [1167](#)  
 ModalityPerformedProcedureStepRetrieveSOP-Class, [1167](#)  
 ModalityPerformedProcedureStepSOPClass, [1167](#)  
 ModalityWorklistInformationModelFIND, [1170](#)  
 MouseGenomeInitiativeMGI, [1172](#)  
 MPEG2MainProfileHighLevel, [1172](#)  
 MPEG2MainProfileMainLevel, [1166](#)  
 MPEG4AVCH\_264HighProfileLevel4\_1, [1172](#)  
 MPEG4AVCH\_264HighProfileLevel4\_2For2DVideo, [1172](#)

- 1173
- MPEG4AVCH\_264HighProfileLevel4\_2For3DVideo, 1173
- MPEG4AVCH\_264StereoHighProfileLevel4\_2, 1173
- MRImageStorage, 1168
- MRSpectroscopyStorage, 1168
- MultiframeGrayscaleByteSecondaryCaptureImageStorage, 1169
- MultiframeGrayscaleWordSecondaryCaptureImageStorage, 1169
- MultiframeSingleBitSecondaryCaptureImageStorage, 1169
- MultiframeTrueColorSecondaryCaptureImageStorage, 1169
- MultipleVolumeRenderingVolumetricPresentationStateStorage, 1173
- NativeDICOMModel, 1175
- NewYorkUniversityMelanomaClinicalCooperativeGroup, 1172
- NuclearMedicineImageStorage, 1169
- NuclearMedicineImageStorageRetired, 1169
- Null0, 1173
- Null1, 1173
- operator TSType, 1186
- OphthalmicAxialMeasurementsStorage, 1173
- OphthalmicOpticalCoherenceTomographyBscanVolumeAnalysisStorage, 1173
- OphthalmicOpticalCoherenceTomographyEnFaceImageStorage, 1173
- OphthalmicPhotography16BitImageStorage, 1170
- OphthalmicPhotography8BitImageStorage, 1170
- OphthalmicThicknessMapStorage, 1173
- OphthalmicTomographyImageStorage, 1170
- OphthalmicVisualFieldStaticPerimetryMeasurementsStorage, 1173
- Papyrus3ImplicitVRLittleEndian, 1172
- ParametricMapStorage, 1173
- PatientRadiationDoseSRStorage, 1174
- PatientRootQueryRetrieveInformationModelFIND, 1170
- PatientRootQueryRetrieveInformationModelGET, 1170
- PatientRootQueryRetrieveInformationModelMOVE, 1170
- PatientStudyOnlyQueryRetrieveInformationModelFINDRetired, 1170
- PatientStudyOnlyQueryRetrieveInformationModelGETRetired, 1170
- PatientStudyOnlyQueryRetrieveInformationModelMOVERetired, 1170
- PerformedImagingAgentAdministrationSRStorage, 1174
- PET20StepColorPaletteSOPInstance, 1172
- PETColorPaletteSOPInstance, 1172
- PlannedImagingAgentAdministrationSRStorage, 1174
- PositronEmissionTomographyImageStorage, 1170
- PresentationLUTSOPClass, 1168
- PrinterConfigurationRetrieveSOPClass, 1168
- PrinterConfigurationRetrieveSOPInstance, 1168
- PrinterSOPClass, 1168
- PrinterSOPInstance, 1168
- PrintJobSOPClass, 1168
- PrintQueueManagementSOPClassRetired, 1168
- PrintQueueSOPInstanceRetired, 1168
- ProceduralEventLoggingSOPClass, 1167
- ProceduralEventLoggingSOPInstance, 1167
- ProcedureLogStorage, 1170
- ProductCharacteristicsQuerySOPClass, 1171
- ProtocolApprovalInformationModelFIND, 1174
- ProtocolApprovalInformationModelGET, 1174
- ProtocolApprovalInformationModelMOVE, 1174
- ProtocolApprovalStorage, 1174
- PseudoColorSoftcopyPresentationStateStorageSOPClass, 1169
- PubChemCompoundCID, 1172
- PullPrintRequestSOPClassRetired, 1168
- PullStoredPrintManagementMetaSOPClassRetired, 1168
- RadiomicsOntology, 1172
- RadiopharmaceuticalRadiationDoseSRStorage, 1174
- RawDataStorage, 1169
- RealWorldValueMappingStorage, 1169
- ReferencedColorPrintManagementMetaSOPClassRetired, 1168
- ReferencedGrayscalePrintManagementMetaSOPClassRetired, 1168
- ReferencedImageBoxSOPClassRetired, 1168
- RespiratoryWaveformStorage, 1173
- RFC2557MIMEencapsulation, 1166
- RLELossless, 1166
- RTBeamsDeliveryInstructionStorage, 1175
- RTBeamsDeliveryInstructionStorageSupplement74FrozenDraft, 1171
- RTBeamsTreatmentRecordStorage, 1170
- RTBrachyApplicationSetupDeliveryInstructionStorage, 1175
- RTBrachyTreatmentRecordStorage, 1170
- RTConventionalMachineVerification, 1175
- RTConventionalMachineVerificationSupplement74FrozenDraft, 1171
- RTDoseStorage, 1170
- RTImageStorage, 1170
- RTIonBeamsTreatmentRecordStorage, 1170
- RTIonMachineVerification, 1175
- RTIonMachineVerificationSupplement74FrozenDraft, 1171



- RTIonPlanStorage, [1170](#)
- RTPhysicianIntentStorage, [1174](#)
- RTPlanStorage, [1170](#)
- RTSegmentAnnotationStorage, [1174](#)
- RTStructureSetStorage, [1170](#)
- RTTreatmentSummaryRecordStorage, [1170](#)
- SecondaryCaptureImageStorage, [1169](#)
- SegmentationStorage, [1169](#)
- SegmentedVolumeRenderingVolumetricPresentationStateStorage, [1173](#)
- SetFromUID, [1186](#)
- SimplifiedAdultEchoSRStorage, [1174](#)
- SpatialFiducialsStorage, [1169](#)
- SpatialRegistrationStorage, [1169](#)
- SpectaclePrescriptionReportStorage, [1173](#)
- SPM2AVG152PDFFrameofReference, [1167](#)
- SPM2AVG152T1FrameofReference, [1167](#)
- SPM2AVG152T2FrameofReference, [1167](#)
- SPM2AVG305T1FrameofReference, [1167](#)
- SPM2BRAINMASKFrameofReference, [1167](#)
- SPM2CSFFFrameofReference, [1167](#)
- SPM2EPIFrameofReference, [1167](#)
- SPM2FILT1FrameofReference, [1167](#)
- SPM2GRAYFrameofReference, [1167](#)
- SPM2PDFFrameofReference, [1167](#)
- SPM2PETFrameofReference, [1167](#)
- SPM2SINGLESUBJT1FrameofReference, [1167](#)
- SPM2SPECTFrameofReference, [1167](#)
- SPM2T1FrameofReference, [1167](#)
- SPM2T2FrameofReference, [1167](#)
- SPM2TRANSMFrameofReference, [1167](#)
- SPM2WHITEFrameofReference, [1167](#)
- SpringColorPaletteSOPInstance, [1172](#)
- StandaloneCurveStorageRetired, [1169](#)
- StandaloneModalityLUTStorageRetired, [1169](#)
- StandaloneOverlayStorageRetired, [1169](#)
- StandalonePETCurveStorageRetired, [1170](#)
- StandaloneVOILUTStorageRetired, [1169](#)
- StereometricRelationshipStorage, [1170](#)
- StorageCommitmentPullModelSOPClassRetired, [1167](#)
- StorageCommitmentPullModelSOPInstanceRetired, [1167](#)
- StorageCommitmentPushModelSOPClass, [1167](#)
- StorageCommitmentPushModelSOPInstance, [1167](#)
- StorageServiceClass, [1168](#)
- StoredPrintStorageSOPClassRetired, [1168](#)
- StudyComponentManagementSOPClassRetired, [1167](#)
- StudyRootQueryRetrieveInformationModelIFIND, [1170](#)
- StudyRootQueryRetrieveInformationModelIGET, [1170](#)
- StudyRootQueryRetrieveInformationModelMOVE, [1170](#)
- SubjectiveRefractionMeasurementsStorage, [1173](#)
- SubstanceAdministrationLoggingSOPClass, [1167](#)
- SubstanceAdministrationLoggingSOPInstance, [1167](#)
- SubstanceApprovalQuerySOPClass, [1171](#)
- SummerColorPaletteSOPInstance, [1172](#)
- SurfaceScanMeshStorage, [1173](#)
- SurfaceScanPointCloudStorage, [1173](#)
- SurfaceSegmentationStorage, [1172](#)
- TalairachBrainAtlasFrameofReference, [1167](#)
- TextSRStorageTrialRetired, [1170](#)
- TractographyResultsStorage, [1173](#)
- TransferSyntaxStringsType, [1165](#)
- TSName, [1166](#)
- TSType, [1175](#)
- UberonOntology, [1172](#)
- uid\_1\_2\_840\_10008\_15\_0\_3\_1, [1180](#)
- uid\_1\_2\_840\_10008\_15\_0\_3\_10, [1181](#)
- uid\_1\_2\_840\_10008\_15\_0\_3\_11, [1181](#)
- uid\_1\_2\_840\_10008\_15\_0\_3\_12, [1181](#)
- uid\_1\_2\_840\_10008\_15\_0\_3\_13, [1181](#)
- uid\_1\_2\_840\_10008\_15\_0\_3\_14, [1181](#)
- uid\_1\_2\_840\_10008\_15\_0\_3\_15, [1181](#)
- uid\_1\_2\_840\_10008\_15\_0\_3\_16, [1181](#)
- uid\_1\_2\_840\_10008\_15\_0\_3\_17, [1181](#)
- uid\_1\_2\_840\_10008\_15\_0\_3\_18, [1181](#)
- uid\_1\_2\_840\_10008\_15\_0\_3\_19, [1181](#)
- uid\_1\_2\_840\_10008\_15\_0\_3\_2, [1180](#)
- uid\_1\_2\_840\_10008\_15\_0\_3\_20, [1181](#)
- uid\_1\_2\_840\_10008\_15\_0\_3\_21, [1181](#)
- uid\_1\_2\_840\_10008\_15\_0\_3\_22, [1181](#)
- uid\_1\_2\_840\_10008\_15\_0\_3\_23, [1181](#)
- uid\_1\_2\_840\_10008\_15\_0\_3\_24, [1181](#)
- uid\_1\_2\_840\_10008\_15\_0\_3\_25, [1181](#)
- uid\_1\_2\_840\_10008\_15\_0\_3\_26, [1181](#)
- uid\_1\_2\_840\_10008\_15\_0\_3\_27, [1181](#)
- uid\_1\_2\_840\_10008\_15\_0\_3\_28, [1181](#)
- uid\_1\_2\_840\_10008\_15\_0\_3\_29, [1181](#)
- uid\_1\_2\_840\_10008\_15\_0\_3\_3, [1181](#)
- uid\_1\_2\_840\_10008\_15\_0\_3\_30, [1181](#)
- uid\_1\_2\_840\_10008\_15\_0\_3\_31, [1181](#)
- uid\_1\_2\_840\_10008\_15\_0\_3\_4, [1181](#)
- uid\_1\_2\_840\_10008\_15\_0\_3\_5, [1181](#)
- uid\_1\_2\_840\_10008\_15\_0\_3\_6, [1181](#)
- uid\_1\_2\_840\_10008\_15\_0\_3\_7, [1181](#)
- uid\_1\_2\_840\_10008\_15\_0\_3\_8, [1181](#)
- uid\_1\_2\_840\_10008\_15\_0\_3\_9, [1181](#)
- uid\_1\_2\_840\_10008\_15\_0\_4\_1, [1181](#)
- uid\_1\_2\_840\_10008\_15\_0\_4\_2, [1181](#)
- uid\_1\_2\_840\_10008\_15\_0\_4\_3, [1181](#)
- uid\_1\_2\_840\_10008\_15\_0\_4\_4, [1181](#)
- uid\_1\_2\_840\_10008\_15\_0\_4\_5, [1181](#)
- uid\_1\_2\_840\_10008\_15\_0\_4\_6, [1181](#)

uid\_1\_2\_840\_10008\_15\_0\_4\_7, 1181  
uid\_1\_2\_840\_10008\_15\_0\_4\_8, 1181  
uid\_1\_2\_840\_10008\_15\_1\_1, 1184  
uid\_1\_2\_840\_10008\_1\_1, 1175  
uid\_1\_2\_840\_10008\_1\_2, 1175  
uid\_1\_2\_840\_10008\_1\_20, 1182  
uid\_1\_2\_840\_10008\_1\_20\_1, 1177  
uid\_1\_2\_840\_10008\_1\_20\_1\_1, 1177  
uid\_1\_2\_840\_10008\_1\_20\_2, 1177  
uid\_1\_2\_840\_10008\_1\_20\_2\_1, 1177  
uid\_1\_2\_840\_10008\_1\_2\_1, 1175  
uid\_1\_2\_840\_10008\_1\_2\_1\_99, 1175  
uid\_1\_2\_840\_10008\_1\_2\_2, 1175  
uid\_1\_2\_840\_10008\_1\_2\_4\_100, 1176  
uid\_1\_2\_840\_10008\_1\_2\_4\_101, 1181  
uid\_1\_2\_840\_10008\_1\_2\_4\_102, 1181  
uid\_1\_2\_840\_10008\_1\_2\_4\_103, 1182  
uid\_1\_2\_840\_10008\_1\_2\_4\_104, 1182  
uid\_1\_2\_840\_10008\_1\_2\_4\_105, 1182  
uid\_1\_2\_840\_10008\_1\_2\_4\_106, 1182  
uid\_1\_2\_840\_10008\_1\_2\_4\_107, 1182  
uid\_1\_2\_840\_10008\_1\_2\_4\_108, 1182  
uid\_1\_2\_840\_10008\_1\_2\_4\_50, 1175  
uid\_1\_2\_840\_10008\_1\_2\_4\_51, 1175  
uid\_1\_2\_840\_10008\_1\_2\_4\_52, 1176  
uid\_1\_2\_840\_10008\_1\_2\_4\_53, 1176  
uid\_1\_2\_840\_10008\_1\_2\_4\_54, 1176  
uid\_1\_2\_840\_10008\_1\_2\_4\_55, 1176  
uid\_1\_2\_840\_10008\_1\_2\_4\_56, 1176  
uid\_1\_2\_840\_10008\_1\_2\_4\_57, 1176  
uid\_1\_2\_840\_10008\_1\_2\_4\_58, 1176  
uid\_1\_2\_840\_10008\_1\_2\_4\_59, 1176  
uid\_1\_2\_840\_10008\_1\_2\_4\_60, 1176  
uid\_1\_2\_840\_10008\_1\_2\_4\_61, 1176  
uid\_1\_2\_840\_10008\_1\_2\_4\_62, 1176  
uid\_1\_2\_840\_10008\_1\_2\_4\_63, 1176  
uid\_1\_2\_840\_10008\_1\_2\_4\_64, 1176  
uid\_1\_2\_840\_10008\_1\_2\_4\_65, 1176  
uid\_1\_2\_840\_10008\_1\_2\_4\_66, 1176  
uid\_1\_2\_840\_10008\_1\_2\_4\_70, 1176  
uid\_1\_2\_840\_10008\_1\_2\_4\_80, 1176  
uid\_1\_2\_840\_10008\_1\_2\_4\_81, 1176  
uid\_1\_2\_840\_10008\_1\_2\_4\_90, 1176  
uid\_1\_2\_840\_10008\_1\_2\_4\_91, 1176  
uid\_1\_2\_840\_10008\_1\_2\_4\_92, 1176  
uid\_1\_2\_840\_10008\_1\_2\_4\_93, 1176  
uid\_1\_2\_840\_10008\_1\_2\_4\_94, 1176  
uid\_1\_2\_840\_10008\_1\_2\_4\_95, 1176  
uid\_1\_2\_840\_10008\_1\_2\_5, 1176  
uid\_1\_2\_840\_10008\_1\_2\_6\_1, 1176  
uid\_1\_2\_840\_10008\_1\_2\_6\_2, 1176  
uid\_1\_2\_840\_10008\_1\_3\_10, 1176  
uid\_1\_2\_840\_10008\_1\_40, 1177  
uid\_1\_2\_840\_10008\_1\_40\_1, 1177  
uid\_1\_2\_840\_10008\_1\_42, 1177  
uid\_1\_2\_840\_10008\_1\_42\_1, 1177  
uid\_1\_2\_840\_10008\_1\_4\_1\_1, 1176  
uid\_1\_2\_840\_10008\_1\_4\_1\_10, 1176  
uid\_1\_2\_840\_10008\_1\_4\_1\_11, 1176  
uid\_1\_2\_840\_10008\_1\_4\_1\_12, 1176  
uid\_1\_2\_840\_10008\_1\_4\_1\_13, 1176  
uid\_1\_2\_840\_10008\_1\_4\_1\_14, 1176  
uid\_1\_2\_840\_10008\_1\_4\_1\_15, 1176  
uid\_1\_2\_840\_10008\_1\_4\_1\_16, 1176  
uid\_1\_2\_840\_10008\_1\_4\_1\_17, 1176  
uid\_1\_2\_840\_10008\_1\_4\_1\_18, 1177  
uid\_1\_2\_840\_10008\_1\_4\_1\_2, 1176  
uid\_1\_2\_840\_10008\_1\_4\_1\_3, 1176  
uid\_1\_2\_840\_10008\_1\_4\_1\_4, 1176  
uid\_1\_2\_840\_10008\_1\_4\_1\_5, 1176  
uid\_1\_2\_840\_10008\_1\_4\_1\_6, 1176  
uid\_1\_2\_840\_10008\_1\_4\_1\_7, 1176  
uid\_1\_2\_840\_10008\_1\_4\_1\_8, 1176  
uid\_1\_2\_840\_10008\_1\_4\_1\_9, 1176  
uid\_1\_2\_840\_10008\_1\_4\_2\_1, 1177  
uid\_1\_2\_840\_10008\_1\_4\_2\_2, 1177  
uid\_1\_2\_840\_10008\_1\_5\_1, 1182  
uid\_1\_2\_840\_10008\_1\_5\_2, 1182  
uid\_1\_2\_840\_10008\_1\_5\_3, 1182  
uid\_1\_2\_840\_10008\_1\_5\_4, 1182  
uid\_1\_2\_840\_10008\_1\_5\_5, 1182  
uid\_1\_2\_840\_10008\_1\_5\_6, 1182  
uid\_1\_2\_840\_10008\_1\_5\_7, 1182  
uid\_1\_2\_840\_10008\_1\_5\_8, 1182  
uid\_1\_2\_840\_10008\_1\_9, 1177  
uid\_1\_2\_840\_10008\_2\_16\_10, 1182  
uid\_1\_2\_840\_10008\_2\_16\_11, 1182  
uid\_1\_2\_840\_10008\_2\_16\_12, 1182  
uid\_1\_2\_840\_10008\_2\_16\_13, 1182  
uid\_1\_2\_840\_10008\_2\_16\_14, 1182  
uid\_1\_2\_840\_10008\_2\_16\_4, 1177  
uid\_1\_2\_840\_10008\_2\_16\_5, 1182  
uid\_1\_2\_840\_10008\_2\_16\_6, 1182  
uid\_1\_2\_840\_10008\_2\_16\_7, 1182  
uid\_1\_2\_840\_10008\_2\_16\_8, 1182  
uid\_1\_2\_840\_10008\_2\_16\_9, 1182  
uid\_1\_2\_840\_10008\_2\_6\_1, 1177  
uid\_1\_2\_840\_10008\_3\_1\_1\_1, 1177  
uid\_1\_2\_840\_10008\_3\_1\_2\_1\_1, 1177  
uid\_1\_2\_840\_10008\_3\_1\_2\_1\_4, 1177  
uid\_1\_2\_840\_10008\_3\_1\_2\_2\_1, 1177  
uid\_1\_2\_840\_10008\_3\_1\_2\_3\_1, 1177  
uid\_1\_2\_840\_10008\_3\_1\_2\_3\_2, 1177  
uid\_1\_2\_840\_10008\_3\_1\_2\_3\_3, 1177  
uid\_1\_2\_840\_10008\_3\_1\_2\_3\_4, 1177  
uid\_1\_2\_840\_10008\_3\_1\_2\_3\_5, 1177  
uid\_1\_2\_840\_10008\_3\_1\_2\_5\_1, 1177  
uid\_1\_2\_840\_10008\_3\_1\_2\_5\_4, 1177



uid\_1\_2\_840\_10008\_3\_1\_2\_5\_5, 1177  
uid\_1\_2\_840\_10008\_3\_1\_2\_6\_1, 1177  
uid\_1\_2\_840\_10008\_4\_2, 1177  
uid\_1\_2\_840\_10008\_5\_1\_1\_1, 1177  
uid\_1\_2\_840\_10008\_5\_1\_1\_14, 1177  
uid\_1\_2\_840\_10008\_5\_1\_1\_15, 1177  
uid\_1\_2\_840\_10008\_5\_1\_1\_16, 1177  
uid\_1\_2\_840\_10008\_5\_1\_1\_16\_376, 1177  
uid\_1\_2\_840\_10008\_5\_1\_1\_17, 1177  
uid\_1\_2\_840\_10008\_5\_1\_1\_17\_376, 1177  
uid\_1\_2\_840\_10008\_5\_1\_1\_18, 1177  
uid\_1\_2\_840\_10008\_5\_1\_1\_18\_1, 1177  
uid\_1\_2\_840\_10008\_5\_1\_1\_2, 1177  
uid\_1\_2\_840\_10008\_5\_1\_1\_22, 1177  
uid\_1\_2\_840\_10008\_5\_1\_1\_23, 1177  
uid\_1\_2\_840\_10008\_5\_1\_1\_24, 1177  
uid\_1\_2\_840\_10008\_5\_1\_1\_24\_1, 1178  
uid\_1\_2\_840\_10008\_5\_1\_1\_25, 1178  
uid\_1\_2\_840\_10008\_5\_1\_1\_26, 1178  
uid\_1\_2\_840\_10008\_5\_1\_1\_27, 1178  
uid\_1\_2\_840\_10008\_5\_1\_1\_29, 1178  
uid\_1\_2\_840\_10008\_5\_1\_1\_30, 1178  
uid\_1\_2\_840\_10008\_5\_1\_1\_31, 1178  
uid\_1\_2\_840\_10008\_5\_1\_1\_32, 1178  
uid\_1\_2\_840\_10008\_5\_1\_1\_33, 1178  
uid\_1\_2\_840\_10008\_5\_1\_1\_4, 1177  
uid\_1\_2\_840\_10008\_5\_1\_1\_40, 1182  
uid\_1\_2\_840\_10008\_5\_1\_1\_40\_1, 1182  
uid\_1\_2\_840\_10008\_5\_1\_1\_4\_1, 1177  
uid\_1\_2\_840\_10008\_5\_1\_1\_4\_2, 1177  
uid\_1\_2\_840\_10008\_5\_1\_1\_9, 1177  
uid\_1\_2\_840\_10008\_5\_1\_1\_9\_1, 1177  
uid\_1\_2\_840\_10008\_5\_1\_4\_1\_1\_1, 1178  
uid\_1\_2\_840\_10008\_5\_1\_4\_1\_1\_10, 1178  
uid\_1\_2\_840\_10008\_5\_1\_4\_1\_1\_104\_1, 1179  
uid\_1\_2\_840\_10008\_5\_1\_4\_1\_1\_104\_2, 1180  
uid\_1\_2\_840\_10008\_5\_1\_4\_1\_1\_104\_3, 1183  
uid\_1\_2\_840\_10008\_5\_1\_4\_1\_1\_11, 1178  
uid\_1\_2\_840\_10008\_5\_1\_4\_1\_1\_11\_1, 1178  
uid\_1\_2\_840\_10008\_5\_1\_4\_1\_1\_11\_10, 1182  
uid\_1\_2\_840\_10008\_5\_1\_4\_1\_1\_11\_11, 1182  
uid\_1\_2\_840\_10008\_5\_1\_4\_1\_1\_11\_2, 1178  
uid\_1\_2\_840\_10008\_5\_1\_4\_1\_1\_11\_3, 1178  
uid\_1\_2\_840\_10008\_5\_1\_4\_1\_1\_11\_4, 1178  
uid\_1\_2\_840\_10008\_5\_1\_4\_1\_1\_11\_5, 1182  
uid\_1\_2\_840\_10008\_5\_1\_4\_1\_1\_11\_6, 1182  
uid\_1\_2\_840\_10008\_5\_1\_4\_1\_1\_11\_7, 1182  
uid\_1\_2\_840\_10008\_5\_1\_4\_1\_1\_11\_8, 1182  
uid\_1\_2\_840\_10008\_5\_1\_4\_1\_1\_11\_9, 1182  
uid\_1\_2\_840\_10008\_5\_1\_4\_1\_1\_128, 1180  
uid\_1\_2\_840\_10008\_5\_1\_4\_1\_1\_128\_1, 1181  
uid\_1\_2\_840\_10008\_5\_1\_4\_1\_1\_129, 1180  
uid\_1\_2\_840\_10008\_5\_1\_4\_1\_1\_12\_1, 1179  
uid\_1\_2\_840\_10008\_5\_1\_4\_1\_1\_12\_1\_1, 1179  
uid\_1\_2\_840\_10008\_5\_1\_4\_1\_1\_12\_2, 1179  
uid\_1\_2\_840\_10008\_5\_1\_4\_1\_1\_12\_2\_1, 1179  
uid\_1\_2\_840\_10008\_5\_1\_4\_1\_1\_12\_3, 1179  
uid\_1\_2\_840\_10008\_5\_1\_4\_1\_1\_12\_77, 1182  
uid\_1\_2\_840\_10008\_5\_1\_4\_1\_1\_130, 1183  
uid\_1\_2\_840\_10008\_5\_1\_4\_1\_1\_131, 1183  
uid\_1\_2\_840\_10008\_5\_1\_4\_1\_1\_13\_1\_1, 1179  
uid\_1\_2\_840\_10008\_5\_1\_4\_1\_1\_13\_1\_2, 1179  
uid\_1\_2\_840\_10008\_5\_1\_4\_1\_1\_13\_1\_3, 1181  
uid\_1\_2\_840\_10008\_5\_1\_4\_1\_1\_13\_1\_4, 1182  
uid\_1\_2\_840\_10008\_5\_1\_4\_1\_1\_13\_1\_5, 1182  
uid\_1\_2\_840\_10008\_5\_1\_4\_1\_1\_14\_1, 1182  
uid\_1\_2\_840\_10008\_5\_1\_4\_1\_1\_14\_2, 1182  
uid\_1\_2\_840\_10008\_5\_1\_4\_1\_1\_1\_1, 1178  
uid\_1\_2\_840\_10008\_5\_1\_4\_1\_1\_1\_1\_1, 1178  
uid\_1\_2\_840\_10008\_5\_1\_4\_1\_1\_1\_2, 1178  
uid\_1\_2\_840\_10008\_5\_1\_4\_1\_1\_1\_2\_1, 1178  
uid\_1\_2\_840\_10008\_5\_1\_4\_1\_1\_1\_3, 1178  
uid\_1\_2\_840\_10008\_5\_1\_4\_1\_1\_1\_3\_1, 1178  
uid\_1\_2\_840\_10008\_5\_1\_4\_1\_1\_2, 1178  
uid\_1\_2\_840\_10008\_5\_1\_4\_1\_1\_20, 1179  
uid\_1\_2\_840\_10008\_5\_1\_4\_1\_1\_200\_1, 1183  
uid\_1\_2\_840\_10008\_5\_1\_4\_1\_1\_200\_2, 1183  
uid\_1\_2\_840\_10008\_5\_1\_4\_1\_1\_200\_3, 1183  
uid\_1\_2\_840\_10008\_5\_1\_4\_1\_1\_200\_4, 1183  
uid\_1\_2\_840\_10008\_5\_1\_4\_1\_1\_200\_5, 1183  
uid\_1\_2\_840\_10008\_5\_1\_4\_1\_1\_200\_6, 1183  
uid\_1\_2\_840\_10008\_5\_1\_4\_1\_1\_2\_1, 1178  
uid\_1\_2\_840\_10008\_5\_1\_4\_1\_1\_2\_2, 1181  
uid\_1\_2\_840\_10008\_5\_1\_4\_1\_1\_3, 1178  
uid\_1\_2\_840\_10008\_5\_1\_4\_1\_1\_30, 1182  
uid\_1\_2\_840\_10008\_5\_1\_4\_1\_1\_3\_1, 1178  
uid\_1\_2\_840\_10008\_5\_1\_4\_1\_1\_4, 1178  
uid\_1\_2\_840\_10008\_5\_1\_4\_1\_1\_40, 1182  
uid\_1\_2\_840\_10008\_5\_1\_4\_1\_1\_481\_1, 1180  
uid\_1\_2\_840\_10008\_5\_1\_4\_1\_1\_481\_10, 1183  
uid\_1\_2\_840\_10008\_5\_1\_4\_1\_1\_481\_11, 1183  
uid\_1\_2\_840\_10008\_5\_1\_4\_1\_1\_481\_2, 1180  
uid\_1\_2\_840\_10008\_5\_1\_4\_1\_1\_481\_3, 1180  
uid\_1\_2\_840\_10008\_5\_1\_4\_1\_1\_481\_4, 1180  
uid\_1\_2\_840\_10008\_5\_1\_4\_1\_1\_481\_5, 1180  
uid\_1\_2\_840\_10008\_5\_1\_4\_1\_1\_481\_6, 1180  
uid\_1\_2\_840\_10008\_5\_1\_4\_1\_1\_481\_7, 1180  
uid\_1\_2\_840\_10008\_5\_1\_4\_1\_1\_481\_8, 1180  
uid\_1\_2\_840\_10008\_5\_1\_4\_1\_1\_481\_9, 1180  
uid\_1\_2\_840\_10008\_5\_1\_4\_1\_1\_4\_1, 1178  
uid\_1\_2\_840\_10008\_5\_1\_4\_1\_1\_4\_2, 1178  
uid\_1\_2\_840\_10008\_5\_1\_4\_1\_1\_4\_3, 1184  
uid\_1\_2\_840\_10008\_5\_1\_4\_1\_1\_4\_4, 1181  
uid\_1\_2\_840\_10008\_5\_1\_4\_1\_1\_5, 1178  
uid\_1\_2\_840\_10008\_5\_1\_4\_1\_1\_501\_1, 1183  
uid\_1\_2\_840\_10008\_5\_1\_4\_1\_1\_501\_2\_1, 1183  
uid\_1\_2\_840\_10008\_5\_1\_4\_1\_1\_501\_2\_2, 1183  
uid\_1\_2\_840\_10008\_5\_1\_4\_1\_1\_501\_3, 1183



- uid\_1\_2\_840\_10008\_5\_1\_4\_33, [1180](#)
- uid\_1\_2\_840\_10008\_5\_1\_4\_34\_1, [1180](#)
- uid\_1\_2\_840\_10008\_5\_1\_4\_34\_10, [1184](#)
- uid\_1\_2\_840\_10008\_5\_1\_4\_34\_2, [1180](#)
- uid\_1\_2\_840\_10008\_5\_1\_4\_34\_3, [1180](#)
- uid\_1\_2\_840\_10008\_5\_1\_4\_34\_4, [1180](#)
- uid\_1\_2\_840\_10008\_5\_1\_4\_34\_4\_1, [1180](#)
- uid\_1\_2\_840\_10008\_5\_1\_4\_34\_4\_2, [1180](#)
- uid\_1\_2\_840\_10008\_5\_1\_4\_34\_4\_3, [1180](#)
- uid\_1\_2\_840\_10008\_5\_1\_4\_34\_4\_4, [1180](#)
- uid\_1\_2\_840\_10008\_5\_1\_4\_34\_5, [1180](#)
- uid\_1\_2\_840\_10008\_5\_1\_4\_34\_5\_1, [1184](#)
- uid\_1\_2\_840\_10008\_5\_1\_4\_34\_6, [1184](#)
- uid\_1\_2\_840\_10008\_5\_1\_4\_34\_6\_1, [1184](#)
- uid\_1\_2\_840\_10008\_5\_1\_4\_34\_6\_2, [1184](#)
- uid\_1\_2\_840\_10008\_5\_1\_4\_34\_6\_3, [1184](#)
- uid\_1\_2\_840\_10008\_5\_1\_4\_34\_6\_4, [1184](#)
- uid\_1\_2\_840\_10008\_5\_1\_4\_34\_7, [1184](#)
- uid\_1\_2\_840\_10008\_5\_1\_4\_34\_8, [1184](#)
- uid\_1\_2\_840\_10008\_5\_1\_4\_34\_9, [1184](#)
- uid\_1\_2\_840\_10008\_5\_1\_4\_37\_1, [1180](#)
- uid\_1\_2\_840\_10008\_5\_1\_4\_37\_2, [1180](#)
- uid\_1\_2\_840\_10008\_5\_1\_4\_37\_3, [1180](#)
- uid\_1\_2\_840\_10008\_5\_1\_4\_38\_1, [1180](#)
- uid\_1\_2\_840\_10008\_5\_1\_4\_38\_2, [1180](#)
- uid\_1\_2\_840\_10008\_5\_1\_4\_38\_3, [1180](#)
- uid\_1\_2\_840\_10008\_5\_1\_4\_38\_4, [1184](#)
- uid\_1\_2\_840\_10008\_5\_1\_4\_39\_1, [1184](#)
- uid\_1\_2\_840\_10008\_5\_1\_4\_39\_2, [1184](#)
- uid\_1\_2\_840\_10008\_5\_1\_4\_39\_3, [1184](#)
- uid\_1\_2\_840\_10008\_5\_1\_4\_39\_4, [1184](#)
- uid\_1\_2\_840\_10008\_5\_1\_4\_41, [1180](#)
- uid\_1\_2\_840\_10008\_5\_1\_4\_42, [1180](#)
- uid\_1\_2\_840\_10008\_5\_1\_4\_43\_1, [1184](#)
- uid\_1\_2\_840\_10008\_5\_1\_4\_43\_2, [1184](#)
- uid\_1\_2\_840\_10008\_5\_1\_4\_43\_3, [1184](#)
- uid\_1\_2\_840\_10008\_5\_1\_4\_43\_4, [1184](#)
- uid\_1\_2\_840\_10008\_5\_1\_4\_44\_1, [1184](#)
- uid\_1\_2\_840\_10008\_5\_1\_4\_44\_2, [1184](#)
- uid\_1\_2\_840\_10008\_5\_1\_4\_44\_3, [1184](#)
- uid\_1\_2\_840\_10008\_5\_1\_4\_44\_4, [1184](#)
- uid\_1\_2\_840\_10008\_5\_1\_4\_45\_1, [1184](#)
- uid\_1\_2\_840\_10008\_5\_1\_4\_45\_2, [1184](#)
- uid\_1\_2\_840\_10008\_5\_1\_4\_45\_3, [1184](#)
- uid\_1\_2\_840\_10008\_5\_1\_4\_45\_4, [1184](#)
- uid\_1\_2\_840\_10008\_7\_1\_1, [1184](#)
- uid\_1\_2\_840\_10008\_7\_1\_2, [1184](#)
- uid\_1\_2\_840\_10008\_8\_1\_1, [1184](#)
- UltrasoundImageStorage, [1169](#)
- UltrasoundImageStorageRetired, [1169](#)
- UltrasoundMultiframeImageStorage, [1168](#)
- UltrasoundMultiframeImageStorageRetired, [1168](#)
- UnifiedProcedureStepEventSOPClass, [1171](#)
- UnifiedProcedureStepEventSOPClass1, [1175](#)
- UnifiedProcedureStepPullSOPClass, [1171](#)
- UnifiedProcedureStepPullSOPClass1, [1174](#)
- UnifiedProcedureStepPushSOPClass, [1171](#)
- UnifiedProcedureStepPushSOPClass1, [1174](#)
- UnifiedProcedureStepWatchSOPClass, [1171](#)
- UnifiedProcedureStepWatchSOPClass1, [1174](#)
- UnifiedWorklistandProcedureStepServiceClass, [1171](#)
- UnifiedWorklistandProcedureStepServiceClass1, [1174](#)
- UnifiedWorklistandProcedureStepSOPInstance, [1171](#)
- UniversalCoordinatedTime, [1175](#)
- UPSFilteredGlobalSubscriptionSOPInstance, [1174](#)
- VerificationSOPClass, [1166](#)
- VideoEndoscopicImageStorage, [1169](#)
- VideoMicroscopicImageStorage, [1169](#)
- VideoPhotographicImageStorage, [1170](#)
- VisualAcuityMeasurementsStorage, [1173](#)
- VLEndoscopicImageStorage, [1169](#)
- VLIImageStorageTrialRetired, [1169](#)
- VLMicroscopicImageStorage, [1169](#)
- VLMultiframeImageStorageTrialRetired, [1169](#)
- VLPotographicImageStorage, [1170](#)
- VLSlideCoordinatesMicroscopicImageStorage, [1170](#)
- VLWholeSlideMicroscopyImageStorage, [1172](#)
- VOILUTBoxSOPClass, [1168](#)
- VolumeRenderingVolumetricPresentationStateStorage, [1173](#)
- WaveformStorageTrialRetired, [1169](#)
- WideFieldOphthalmicPhotography3DCoordinatesImageStorage, [1173](#)
- WideFieldOphthalmicPhotographyStereographicProjectionImageStorage, [1173](#)
- WinterColorPaletteSOPInstance, [1172](#)
- XAXRFGrayscaleSoftcopyPresentationStateStorage, [1173](#)
- XMLEncoding, [1166](#)
- XRay3DAngiographicImageStorage, [1169](#)
- XRay3DCraniofacialImageStorage, [1169](#)
- XRayAngiographicBiPlaneImageStorageRetired, [1169](#)
- XRayAngiographicImageStorage, [1169](#)
- XRayRadiationDoseSRStorage, [1170](#)
- XRayRadiofluoroscopicImageStorage, [1169](#)
- gdcmm::UNExplicitDataElement, [1254](#)
  - GetLength, [1255](#)
  - Read, [1256](#)
  - ReadPreValue, [1256](#)
  - ReadValue, [1256](#)
  - ReadWithLength, [1256](#)
- gdcmm::UNExplicitImplicitDataElement, [1257](#)
  - GetLength, [1258](#)
  - Read, [1258](#)

- ReadPreValue, [1258](#)
- ReadValue, [1258](#)
- gdcmm::Unpacker12Bits, [1259](#)
  - Pack, [1259](#)
  - Unpack, [1260](#)
- gdcmm::Usage, [1260](#)
  - Conditional, [1261](#)
  - GetUsageString, [1262](#)
  - GetUsageType, [1262](#)
  - Invalid, [1261](#)
  - Mandatory, [1261](#)
  - operator UsageType, [1262](#)
  - operator<<, [1262](#)
  - Usage, [1262](#)
  - UsageType, [1261](#)
  - UserOption, [1261](#)
- gdcmm::UserEvent, [1263](#)
- gdcmm::UUIDGenerator, [1266](#)
  - Generate, [1267](#)
  - IsValid, [1267](#)
- gdcmm::Validate, [1267](#)
  - ~Validate, [1268](#)
  - F, [1269](#)
  - GetValidatedFile, [1268](#)
  - SetFile, [1268](#)
  - V, [1269](#)
  - Validate, [1268](#)
  - Validation, [1269](#)
- gdcmm::Value, [1270](#)
  - ~Value, [1271](#)
  - Clear, [1271](#)
  - DataElement, [1272](#)
  - GetLength, [1271](#)
  - operator==, [1272](#)
  - SetLength, [1272](#)
  - SetLengthOnly, [1272](#)
  - Value, [1271](#)
- gdcmm::ValueIO< TDE, TSwap, TType >, [1273](#)
  - Read, [1273](#)
  - Write, [1273](#)
- gdcmm::Version, [1274](#)
  - ~Version, [1275](#)
  - GetBuildVersion, [1275](#)
  - GetMajorVersion, [1276](#)
  - GetMinorVersion, [1276](#)
  - GetVersion, [1276](#)
  - operator<<, [1276](#)
  - Print, [1276](#)
  - Version, [1275](#)
- gdcmm::VL, [1277](#)
  - GetLength, [1278](#)
  - GetVL16Max, [1278](#)
  - GetVL32Max, [1279](#)
  - IsOdd, [1279](#)
  - IsUndefined, [1279](#)
  - operator uint32\_t, [1279](#)
  - operator<<, [1281](#)
  - operator++, [1279](#)
  - operator+=", [1279](#)
  - Read, [1280](#)
  - Read16, [1280](#)
  - SetToUndefined, [1280](#)
  - Type, [1278](#)
  - VL, [1278](#)
  - Write, [1280](#)
  - Write16, [1280](#)
- gdcmm::VM, [1281](#)
  - Compatible, [1284](#)
  - GetIndex, [1284](#)
  - GetLength, [1284](#)
  - GetNumberOfElementsFromArray, [1284](#)
  - GetVMString, [1284](#)
  - GetVMType, [1285](#)
  - GetVMTypeFromLength, [1285](#)
  - IsValid, [1285](#)
  - operator VMType, [1285](#)
  - operator<<, [1285](#)
  - VM, [1284](#)
  - VM0, [1283](#)
  - VM1, [1283](#)
  - VM10, [1283](#)
  - VM12, [1283](#)
  - VM16, [1283](#)
  - VM18, [1283](#)
  - VM1\_2, [1283](#)
  - VM1\_3, [1283](#)
  - VM1\_32, [1283](#)
  - VM1\_4, [1283](#)
  - VM1\_5, [1283](#)
  - VM1\_8, [1283](#)
  - VM1\_99, [1283](#)
  - VM1\_n, [1283](#)
  - VM2, [1283](#)
  - VM24, [1283](#)
  - VM256, [1283](#)
  - VM28, [1283](#)
  - VM2\_2n, [1283](#)
  - VM2\_n, [1283](#)
  - VM3, [1283](#)
  - VM30\_30n, [1283](#)
  - VM32, [1283](#)
  - VM35, [1283](#)
  - VM3\_3n, [1283](#)
  - VM3\_4, [1283](#)
  - VM3\_n, [1283](#)
  - VM4, [1283](#)
  - VM47\_47n, [1283](#)
  - VM4\_4n, [1283](#)

- VM5, [1283](#)
- VM6, [1283](#)
- VM6\_6n, [1283](#)
- VM6\_n, [1283](#)
- VM7\_7n, [1283](#)
- VM8, [1283](#)
- VM9, [1283](#)
- VM99, [1283](#)
- VM\_END, [1283](#)
- VMType, [1283](#)
- gdcM::VMToLength< T >, [1286](#)
- gdcM::VR, [1286](#)
  - AE, [1288](#)
  - AS, [1288](#)
  - AT, [1288](#)
  - CanDisplay, [1289](#)
  - Compatible, [1290](#)
  - CS, [1288](#)
  - DA, [1288](#)
  - DS, [1288](#)
  - DT, [1288](#)
  - FD, [1288](#)
  - FL, [1288](#)
  - GetLength, [1290](#)
  - GetSize, [1290](#)
  - GetSizeof, [1290](#)
  - GetVRString, [1290](#)
  - GetVRStringFromFile, [1291](#)
  - GetVRType, [1291](#)
  - GetVRTypeFromFile, [1291](#)
  - INVALID, [1288](#)
  - IS, [1288](#)
  - IsASCII, [1291](#)
  - IsASCII2, [1291](#)
  - IsBinary, [1291](#)
  - IsBinary2, [1292](#)
  - IsDual, [1292](#)
  - IsSwap, [1292](#)
  - IsValid, [1292](#)
  - IsVRFile, [1292](#)
  - LO, [1288](#)
  - LT, [1288](#)
  - OB, [1288](#)
  - OB\_OW, [1289](#)
  - OD, [1288](#)
  - OF, [1288](#)
  - OL, [1288](#)
  - operator VRType, [1293](#)
  - operator<<, [1293](#)
  - OV, [1288](#)
  - OW, [1288](#)
  - PN, [1288](#)
  - Read, [1293](#)
  - SH, [1288](#)
  - SL, [1289](#)
  - SQ, [1289](#)
  - SS, [1289](#)
  - ST, [1289](#)
  - SV, [1289](#)
  - TM, [1289](#)
  - UC, [1289](#)
  - UI, [1289](#)
  - UL, [1289](#)
  - UN, [1289](#)
  - UR, [1289](#)
  - US, [1289](#)
  - US\_OW, [1289](#)
  - US\_SS, [1289](#)
  - US\_SS\_OW, [1289](#)
  - UT, [1289](#)
  - UV, [1289](#)
  - VL16, [1289](#)
  - VL32, [1289](#)
  - VR, [1289](#)
  - VR\_END, [1289](#)
  - VR\_VM1, [1289](#)
  - VRALL, [1289](#)
  - VRASCII, [1289](#)
  - VRBINARY, [1289](#)
  - VRType, [1288](#)
  - Write, [1293](#)
- gdcM::VR16ExplicitDataElement, [1294](#)
  - GetLength, [1295](#)
  - Read, [1295](#)
  - ReadPreValue, [1295](#)
  - ReadValue, [1295](#)
  - ReadWithLength, [1296](#)
- gdcM::VRToEncoding< T >, [1296](#)
- gdcM::VRToType< T >, [1296](#)
- gdcM::VRVLSIZE< 0 >, [1297](#)
  - Read, [1297](#)
  - Write, [1297](#)
- gdcM::VRVLSIZE< 1 >, [1297](#)
  - Read, [1298](#)
  - Write, [1298](#)
- gdcM::VRVLSIZE< T >, [1297](#)
- gdcM::Waveform, [1414](#)
  - Waveform, [1415](#)
- gdcM::WLMFindQuery, [1415](#)
  - GetAbstractSyntaxUID, [1417](#)
  - GetTagListByLevel, [1417](#)
  - GetValidDataSet, [1417](#)
  - InitializeDataSet, [1417](#)
  - QueryFactory, [1418](#)
  - ValidateQuery, [1417](#)
  - WLMFindQuery, [1416](#)
- gdcM::Writer, [1418](#)
  - ~Writer, [1421](#)

- CheckFileMetaInformationOff, [1421](#)
- CheckFileMetaInformationOn, [1421](#)
- GetCheckFileMetaInformation, [1421](#)
- GetFile, [1421](#)
- GetStreamPtr, [1422](#)
- Ofstream, [1424](#)
- SetCheckFileMetaInformation, [1422](#)
- SetFile, [1422](#)
- SetFileName, [1422](#)
- SetStream, [1423](#)
- SetWriteDataSetOnly, [1423](#)
- Stream, [1424](#)
- StreamImageWriter, [1424](#)
- Write, [1423](#)
- Writer, [1421](#)
- gdcM::XMLDictReader, [1424](#)
- ~XMLDictReader, [1425](#)
- CharacterDataHandler, [1426](#)
- EndElement, [1426](#)
- GetDict, [1426](#)
- HandleDescription, [1426](#)
- HandleEntry, [1426](#)
- StartElement, [1427](#)
- XMLDictReader, [1425](#)
- gdcM::XMLPrinter, [1427](#)
- ~XMLPrinter, [1429](#)
- F, [1430](#)
- GetPrintStyle, [1429](#)
- HandleBulkData, [1429](#)
- LOADBULKDATA, [1428](#)
- OnlyUUID, [1428](#)
- Print, [1429](#)
- PrintDataElement, [1429](#)
- PrintDataSet, [1430](#)
- PrintSQ, [1430](#)
- PrintStyle, [1431](#)
- PrintStyles, [1428](#)
- SetFile, [1430](#)
- SetStyle, [1430](#)
- XMLPrinter, [1429](#)
- gdcM::XMLPrivateDictReader, [1431](#)
- ~XMLPrivateDictReader, [1432](#)
- CharacterDataHandler, [1432](#)
- EndElement, [1433](#)
- GetPrivateDict, [1433](#)
- HandleDescription, [1433](#)
- HandleEntry, [1433](#)
- StartElement, [1433](#)
- XMLPrivateDictReader, [1432](#)
- GDCM\_DIFFERENT
- gdcM, [61](#)
- GDCM\_DO\_JOIN
- gdcMStaticAssert.h, [1651](#)
- GDCM\_DO\_JOIN2
- gdcMStaticAssert.h, [1652](#)
- GDCM\_EQUAL
- gdcM, [61](#)
- GDCM\_EXPORT
- gdcMWin32.h, [1709](#)
- GDCM\_FUNCTION
- gdcMTrace.h, [1675](#)
- GDCM\_GREATER
- gdcM, [61](#)
- GDCM\_GREATEROREQUAL
- gdcM, [61](#)
- GDCM\_JOIN
- gdcMStaticAssert.h, [1652](#)
- GDCM\_LEGACY
- gdcMLegacyMacro.h, [1557](#)
- GDCM\_LEGACY\_BODY
- gdcMLegacyMacro.h, [1558](#)
- GDCM\_LEGACY\_REPLACED\_BODY
- gdcMLegacyMacro.h, [1558](#)
- GDCM\_LESS
- gdcM, [61](#)
- GDCM\_LESOREQUAL
- gdcM, [61](#)
- GDCM\_NOOP\_STATEMENT
- gdcMLegacyMacro.h, [1558](#)
- GDCM\_STATIC\_ASSERT
- gdcM::Attribute< Group, Element, TVR, TVM >, [137](#)
- gdcM::Attribute< Group, Element, TVR, VM::VM1 >, [146](#)
- gdcM::Attribute< Group, Element, TVR, VM::VM1\_n >, [155](#)
- gdcMStaticAssert.h, [1652](#)
- gdcMAAbortPDU.h, [1435](#)
- gdcMAAssociateACPDU.h, [1436](#)
- gdcMAAssociateRJPDU.h, [1436](#)
- gdcMAAssociateRQPDU.h, [1437](#)
- gdcMAbstractSyntax.h, [1438](#)
- gdcMAnonymizeEvent.h, [1439](#)
- gdcMAnonymizer.h, [1440](#)
- gdcMApplicationContext.h, [1441](#)
- gdcMApplicationEntity.h, [1442](#)
- gdcMReleaseRPPDU.h, [1442](#)
- gdcMReleaseRQPDU.h, [1443](#)
- gdcMARTIMTimer.h, [1444](#)
- gdcMASN1.h, [1445](#)
- gdcMAssertAlwaysMacro
- gdcMTrace.h, [1675](#)
- gdcMAssertMacro
- gdcMTrace.h, [1675](#)
- gdcMAsynchronousOperationsWindowSub.h, [1446](#)
- gdcMAttribute.h, [1446](#)
- gdcMAudioCodec.h, [1448](#)
- gdcMBase64.h, [1449](#)
- gdcMBaseCompositeMessage.h, [1449](#)

gdcmbaseNormalizedMessage.h, 1450  
gdcmbasePDU.h, 1451  
gdcmbaseQuery.h, 1452  
gdcmbaseRootQuery.h, 1453  
gdcmbasicOffsetTable.h, 1454  
gdcmbitmap.h, 1455  
gdcmbitmapToBitmapFilter.h, 1456  
gdcmboxRegion.h, 1457  
gdcmbuffer.h, 1457  
gdcmbyteswap.h, 1459  
gdcmbyteswapFilter.h, 1459  
gdcmbyteValue.h, 1460  
gdcmbasicCryptoFactory.h, 1461  
gdcmbasicCryptographicMessageSyntax.h, 1462  
gdcmbasicEchoMessages.h, 1462  
gdcmbasicFindMessages.h, 1463  
gdcmbasicMoveMessages.h, 1464  
gdcmbasicCodec.h, 1465  
gdcmbasicCoder.h, 1466  
gdcmbasicCodeString.h, 1468  
gdcmbasicCommand.h, 1469  
gdcmbasicCommandDataSet.h, 1470  
gdcmbasicCompositeMessageFactory.h, 1471  
gdcmbasicCompositeNetworkFunctions.h, 1471  
gdcmbasicConstCharWrapper.h, 1472  
gdcmbasicCP246ExplicitDataElement.h, 1472  
gdcmbasicCryptoFactory.h, 1473  
gdcmbasicCryptographicMessageSyntax.h, 1474  
gdcmbasicCSAElement.h, 1475  
gdcmbasicCSAHeader.h, 1476  
gdcmbasicCSAHeaderDict.h, 1477  
gdcmbasicCSAHeaderDictEntry.h, 1478  
gdcmbasicCStoreMessages.h, 1479  
gdcmbasicCurve.h, 1480  
gdcmbasicDataElement.h, 1481  
gdcmbasicDataEvent.h, 1483  
gdcmbasicDataSet.h, 1484  
gdcmbasicDataSetEvent.h, 1485  
gdcmbasicDataSetHelper.h, 1485  
gdcmbasicDebugMacro  
    gdcmbasicTrace.h, 1676  
gdcmbasicDecoder.h, 1486  
gdcmbasicDefinedTerms.h, 1488  
gdcmbasicDeflateStream.h, 1488  
gdcmbasicDefs.h, 1489  
gdcmbasicDeltaEncodingCodec.h, 1490  
gdcmbasicDICOMDIR.h, 1491  
gdcmbasicDICOMDIRGenerator.h, 1492  
gdcmbasicDict.h, 1492  
gdcmbasicDictConverter.h, 1494  
gdcmbasicDictEntry.h, 1494  
gdcmbasicDictPrinter.h, 1496  
gdcmbasicDicts.h, 1496  
gdcmbasicDIMSE.h, 1498  
gdcmbasicDirectionCosines.h, 1498  
gdcmbasicDirectory.h, 1499  
gdcmbasicDirectoryHelper.h, 1500  
gdcmbasicDummyValueGenerator.h, 1501  
gdcmbasicDumper.h, 1502  
gdcmbasicElement.h, 1502  
gdcmbasicEmptyMaskGenerator.h, 1504  
gdcmbasicEncapsulatedDocument.h, 1505  
gdcmbasicEnumeratedValues.h, 1505  
gdcmbasicEquipmentManufacturer.h, 1506  
gdcmbasicErrorMacro  
    gdcmbasicTrace.h, 1676  
gdcmbasicEvent.h, 1507  
    gdcmbasicEventMacro, 1508  
gdcmbasicEventMacro  
    gdcmbasicEvent.h, 1508  
gdcmbasicException.h, 1508  
gdcmbasicExplicitDataElement.h, 1509  
gdcmbasicExplicitImplicitDataElement.h, 1510  
gdcmbasicFiducials.h, 1511  
gdcmbasicFile.h, 1511  
gdcmbasicFileAnonymizer.h, 1513  
gdcmbasicFileChangeTransferSyntax.h, 1513  
gdcmbasicFileDecompressLookupTable.h, 1514  
gdcmbasicFileDerivation.h, 1515  
gdcmbasicFileExplicitFilter.h, 1516  
gdcmbasicFileMetaInformation.h, 1517  
gdcmbasicFilename.h, 1518  
gdcmbasicFileNameEvent.h, 1518  
gdcmbasicFilenameGenerator.h, 1519  
gdcmbasicFileSet.h, 1520  
gdcmbasicFileStreamer.h, 1521  
gdcmbasicFindPatientRootQuery.h, 1522  
gdcmbasicFindStudyRootQuery.h, 1523  
gdcmbasicFragment.h, 1523  
gdcmbasicGlobal.h, 1525  
gdcmbasicGroupDict.h, 1526  
gdcmbasicIconImage.h, 1526  
gdcmbasicIconImageFilter.h, 1527  
gdcmbasicIconImageGenerator.h, 1528  
gdcmbasicImage.h, 1529  
gdcmbasicImageApplyLookupTable.h, 1530  
gdcmbasicImageChangePhotometricInterpretation.h, 1531  
gdcmbasicImageChangePlanarConfiguration.h, 1532  
gdcmbasicImageChangeTransferSyntax.h, 1532  
gdcmbasicImageCodec.h, 1533  
gdcmbasicImageConverter.h, 1534  
gdcmbasicImageFragmentSplitter.h, 1535  
gdcmbasicImageHelper.h, 1536  
gdcmbasicImageReader.h, 1537  
gdcmbasicImageRegionReader.h, 1538  
gdcmbasicImageToImageFilter.h, 1538  
gdcmbasicImageWriter.h, 1539  
gdcmbasicImplementationClassUIDSub.h, 1540



gdcmImplementationUIDSub.h, 1541  
gdcmImplementationVersionNameSub.h, 1542  
gdcmImplicitDataElement.h, 1543  
gdcmIOD.h, 1544  
gdcmIODEntry.h, 1545  
gdcmIODs.h, 1547  
gdcmIPPSorter.h, 1548  
gdcmItem.h, 1549  
gdcmJPEG12Codec.h, 1551  
gdcmJPEG16Codec.h, 1551  
gdcmJPEG2000Codec.h, 1552  
gdcmJPEG8Codec.h, 1553  
gdcmJPEGCodec.h, 1554  
gdcmJPEGLSCodec.h, 1555  
gdcmJSON.h, 1555  
gdcmKAKADUCodec.h, 1556  
gdcmLegacyMacro.h, 1557  
    GDCM\_LEGACY, 1557  
    GDCM\_LEGACY\_BODY, 1558  
    GDCM\_LEGACY\_REPLACED\_BODY, 1558  
    GDCM\_NOOP\_STATEMENT, 1558  
gdcmLO.h, 1559  
gdcmLookupTable.h, 1559  
gdcmMacro.h, 1560  
gdcmMacroEntry.h, 1562  
    GDCMMACROENTRY\_H, 1563  
GDCMMACROENTRY\_H  
    gdcmMacroEntry.h, 1563  
gdcmMacros.h, 1564  
gdcmMaxLengthSub.h, 1565  
gdcmMD5.h, 1567  
gdcmMediaStorage.h, 1567  
gdcmMeshPrimitive.h, 1569  
gdcmModalityPerformedProcedureStepCreateQuery.h,  
    1570  
gdcmModalityPerformedProcedureStepSetQuery.h, 1571  
gdcmModule.h, 1571  
gdcmModuleEntry.h, 1573  
gdcmModules.h, 1575  
gdcmMovePatientRootQuery.h, 1576  
gdcmMoveStudyRootQuery.h, 1577  
gdcmMrProtocol.h, 1577  
gdcmNActionMessages.h, 1579  
gdcmNCreateMessages.h, 1579  
gdcmNDeleteMessages.h, 1580  
gdcmNestedModuleEntries.h, 1581  
gdcmNetworkEvents.h, 1582  
gdcmNetworkStateID.h, 1583  
gdcmNEventReportMessages.h, 1584  
gdcmNGetMessages.h, 1585  
gdcmNormalizedMessageFactory.h, 1585  
gdcmNormalizedNetworkFunctions.h, 1586  
gdcmNSetMessages.h, 1587  
gdcmObject.h, 1587  
gdcmOpenSSLCryptoFactory.h, 1589  
gdcmOpenSSLCryptographicMessageSyntax.h, 1589  
gdcmOpenSSL7CryptoFactory.h, 1591  
gdcmOpenSSL7CryptographicMessageSyntax.h, 1591  
gdcmOrientation.h, 1593  
gdcmOverlay.h, 1593  
gdcmParseException.h, 1594  
gdcmParser.h, 1596  
gdcmPatient.h, 1596  
gdcmPDataTFPDU.h, 1597  
gdcmPDBElement.h, 1598  
gdcmPDBHeader.h, 1599  
gdcmPDFCodec.h, 1600  
gdcmPDUFactory.h, 1601  
gdcmPersonName.h, 1601  
gdcmPGXCodec.h, 1602  
gdcmPhotometricInterpretation.h, 1603  
gdcmPixelFormat.h, 1604  
gdcmPixmap.h, 1605  
gdcmPixmapReader.h, 1606  
gdcmPixmapToPixmapFilter.h, 1607  
gdcmPixmapWriter.h, 1607  
gdcmPNMCodec.h, 1609  
gdcmPreamble.h, 1609  
gdcmPresentationContext.h, 1611  
gdcmPresentationContextAC.h, 1612  
gdcmPresentationContextGenerator.h, 1613  
gdcmPresentationContextRQ.h, 1613  
gdcmPresentationDataValue.h, 1614  
gdcmPrinter.h, 1615  
gdcmPrivateTag.h, 1617  
gdcmProgressEvent.h, 1618  
gdcmPVRGCodec.h, 1619  
gdcmPythonFilter.h, 1619  
gdcmQueryBase.h, 1620  
gdcmQueryFactory.h, 1621  
gdcmQueryImage.h, 1622  
gdcmQueryPatient.h, 1623  
gdcmQuerySeries.h, 1624  
gdcmQueryStudy.h, 1625  
gdcmRAWCodec.h, 1626  
gdcmReader.h, 1626  
gdcmRegion.h, 1628  
gdcmRescaler.h, 1629  
gdcmRLECodec.h, 1630  
gdcmRoleSelectionSub.h, 1630  
gdcmScanner.h, 1631  
gdcmSegment.h, 1632  
gdcmSegmentedPaletteColorLookupTable.h, 1633  
gdcmSegmentHelper.h, 1634  
gdcmSegmentReader.h, 1635  
gdcmSegmentWriter.h, 1636  
gdcmSequenceOfFragments.h, 1637  
gdcmSequenceOfItems.h, 1638



- gdcSerieHelper.h, 1638
- gdcSeries.h, 1640
- gdcServiceClassApplicationInformation.h, 1641
- gdcServiceClassUser.h, 1642
- gdcSHA1.h, 1642
- gdcSimpleSubjectWatcher.h, 1643
- gdcSmartPointer.h, 1644
- gdcSOPClassExtendedNegotiationSub.h, 1645
- gdcSOPClassUIDToIOD.h, 1646
- gdcSorter.h, 1647
- gdcSpacing.h, 1649
- gdcSpectroscopy.h, 1649
- gdcSplitMosaicFilter.h, 1650
- gdcStaticAssert.h, 1651
  - GDCM\_DO\_JOIN, 1651
  - GDCM\_DO\_JOIN2, 1652
  - GDCM\_JOIN, 1652
  - GDCM\_STATIC\_ASSERT, 1652
- gdcStreamImageReader.h, 1653
- gdcStreamImageWriter.h, 1653
- gdcStrictScanner.h, 1654
- gdcString.h, 1655
- gdcStringFilter.h, 1656
- gdcStudy.h, 1657
- gdcSubject.h, 1658
- gdcSurface.h, 1659
- gdcSurfaceHelper.h, 1660
- gdcSurfaceReader.h, 1661
- gdcSurfaceWriter.h, 1662
- gdcSwapCode.h, 1662
- gdcSwapper.h, 1664
- gdcSystem.h, 1665
- gdcTable.h, 1665
- gdcTableEntry.h, 1666
- gdcTableReader.h, 1668
- gdcTag.h, 1669
- gdcTagPath.h, 1670
- gdcTagToVR.h, 1670
- gdcTerminal.h, 1671
- gdcTestDriver.h, 1672
- gdcTesting.h, 1673
- gdcTrace.h, 1674
  - GDCM\_FUNCTION, 1675
  - gdcAssertAlwaysMacro, 1675
  - gdcAssertMacro, 1675
  - gdcDebugMacro, 1676
  - gdcErrorMacro, 1676
  - gdcWarningMacro, 1678
- gdcTransferSyntax.h, 1678
- gdcTransferSyntaxSub.h, 1680
- gdcType.h, 1681
- gdcTypes.h, 1682
- gdcUIDGenerator.h, 1682
- gdcUIDs.h, 1683
- gdcULAction.h, 1684
- gdcULActionAA.h, 1685
- gdcULActionAE.h, 1685
- gdcULActionAR.h, 1686
- gdcULActionDT.h, 1687
- gdcULBasicCallback.h, 1687
- gdcULConnection.h, 1688
- gdcULConnectionCallback.h, 1689
- gdcULConnectionInfo.h, 1690
- gdcULConnectionManager.h, 1691
- gdcULEvent.h, 1692
- gdcULTransitionTable.h, 1693
- gdcULWritingCallback.h, 1694
- gdcUNExplicitDataElement.h, 1695
- gdcUNExplicitImplicitDataElement.h, 1695
- gdcUnpacker12Bits.h, 1696
- gdcUsage.h, 1697
- gdcUserInformation.h, 1699
- gdcUUIIDGenerator.h, 1700
- gdcValidate.h, 1700
- gdcValue.h, 1701
- gdcValueIO.h, 1702
- gdcVersion.h, 1702
- gdcVL.h, 1703
- gdcVM.h, 1704
  - TYPETOLENGTH, 1705
- gdcVR.h, 1705
  - TYPETOENCODING, 1707
  - VRTypeTemplateCase, 1707
- gdcVR16ExplicitDataElement.h, 1707
- gdcWarningMacro
  - gdcTrace.h, 1678
- gdcWaveform.h, 1708
- gdcWin32.h, 1708
  - GDCM\_EXPORT, 1709
- gdcWLMFindQuery.h, 1709
- gdcWriter.h, 1710
- gdcXMLDictReader.h, 1711
- gdcXMLPrinter.h, 1711
- gdcXMLPrivateDictReader.h, 1712
- GEMS
  - gdcm::Dicts, 377
  - gdcm::EquipmentManufacturer, 433
- GeneralAudioWaveformStorage
  - gdcm::UIDs, 1173
- GeneralECGWaveformStorage
  - gdcm::MediaStorage, 680
  - gdcm::UIDs, 1169
- GeneralElectricMagneticResonanceImageStorage
  - gdcm::MediaStorage, 681
- GeneralPurposePerformedProcedureStepSOPClass
  - gdcm::UIDs, 1171
- GeneralPurposeScheduledProcedureStepSOPClass
  - gdcm::UIDs, 1171

- GeneralPurposeWorklistInformationModelFIND
  - gdcm::UIDs, [1170](#)
- GeneralPurposeWorklistManagementMetaSOPClass
  - gdcm::UIDs, [1171](#)
- GeneralRelevantPatientInformationQuery
  - gdcm::UIDs, [1171](#)
- Generate
  - gdcm::DICOMDIRGenerator, [357](#)
  - gdcm::DummyValueGenerator, [393](#)
  - gdcm::FilenameGenerator, [489](#)
  - gdcm::IconImageGenerator, [522](#)
  - gdcm::UIDGenerator, [1148](#)
  - gdcm::UUIIDGenerator, [1267](#)
- GenerateFromFileNames
  - gdcm::PresentationContextGenerator, [853](#)
- GenerateFromUID
  - gdcm::PresentationContextGenerator, [854](#)
- GenerateUUID
  - gdcm::UIDGenerator, [1148](#)
- GenericImplantTemplateInformationModelFIND
  - gdcm::UIDs, [1175](#)
- GenericImplantTemplateInformationModelGET
  - gdcm::UIDs, [1175](#)
- GenericImplantTemplateInformationModelMOVE
  - gdcm::UIDs, [1175](#)
- GenericImplantTemplateStorage
  - gdcm::UIDs, [1175](#)
- GEPrivate3DModelStorage
  - gdcm::MediaStorage, [681](#)
- Get
  - gdcm::ByteBuffer, [218](#)
- GetAbbreviation
  - gdcm::GroupDict, [516](#)
- GetAbstractSyntax
  - gdcm::network::PresentationContextRQ, [857](#)
  - gdcm::PresentationContext, [847](#)
- GetAbstractSyntaxUID
  - gdcm::BaseQuery, [180](#)
  - gdcm::FindPatientRootQuery, [502](#)
  - gdcm::FindStudyRootQuery, [505](#)
  - gdcm::ModalityPerformedProcedureStepCreateQuery, [700](#)
  - gdcm::ModalityPerformedProcedureStepSetQuery, [703](#)
  - gdcm::MovePatientRootQuery, [716](#)
  - gdcm::MoveStudyRootQuery, [719](#)
  - gdcm::WLMFindQuery, [1417](#)
- GetAcceptedPresentationContexts
  - gdcm::network::ULConnection, [1231](#), [1232](#)
- GetAcquisitionSize
  - gdcm::SplitMosaicFilter, [1021](#)
- GetAETitle
  - gdcm::ServiceClassUser, [985](#)
- GetAlgorithmFamily
  - gdcm::Surface, [1063](#)
- GetAlgorithmName
  - gdcm::Surface, [1063](#)
- GetAlgorithmVersion
  - gdcm::Surface, [1063](#)
- GetALGOType
  - gdcm::Segment, [939](#)
- GetALGOTypeString
  - gdcm::Segment, [939](#)
- GetAllFileNamesFromTagToValue
  - gdcm::Scanner, [932](#)
  - gdcm::StrictScanner, [1041](#)
- GetAllRequiredTags
  - gdcm::QueryBase, [884](#)
- GetAllTags
  - gdcm::QueryBase, [884](#)
- GetAnatomicRegion
  - gdcm::Segment, [940](#)
- GetAnatomicRegionModifiers
  - gdcm::Segment, [940](#)
- GetAsDataElement
  - gdcm::Attribute< Group, Element, TVR, TVM >, [137](#)
  - gdcm::Attribute< Group, Element, TVR, VM::VM1 >, [146](#)
  - gdcm::Attribute< Group, Element, TVR, VM::VM1\_n >, [155](#)
  - gdcm::Element< TVR, TVM >, [397](#)
  - gdcm::Element< TVR, VM::VM1\_n >, [405](#)
  - gdcm::network::AbstractSyntax, [105](#)
  - gdcm::PrivateTag, [873](#)
- GetAsPoints
  - gdcm::Curve, [305](#)
- GetAsString
  - gdcm::CodeString, [255](#)
- GetAxisOfRotation
  - gdcm::Surface, [1063](#)
- GetBasicApplicationLevelConfidentialityProfileAttributes
  - gdcm::Anonymizer, [114](#)
- GetBitPosition
  - gdcm::Overlay, [770](#)
- GetBitsAllocated
  - gdcm::Overlay, [770](#)
  - gdcm::PixelFormat, [813](#)
- GetBitSample
  - gdcm::LookupTable, [662](#)
- GetBitsStored
  - gdcm::PixelFormat, [813](#)
- GetBlob
  - gdcm::network::PresentationDataValue, [860](#)
- GetBuffer
  - gdcm::Bitmap, [198](#)
  - gdcm::ByteValue, [226](#)
  - gdcm::Parser, [782](#)
  - gdcm::SequenceOfFragments, [961](#)

- GetBuffer2
  - gdcm::Bitmap, 198
- GetBufferAsRGBA
  - gdcm::LookupTable, 662
- GetBufferLength
  - gdcm::Bitmap, 198
  - gdcm::JPEGLSCodec, 646
  - gdcm::PNMCodec, 839
  - gdcm::RLECodec, 923
- GetBuildVersion
  - gdcm::Version, 1275
- GetByteValue
  - gdcm::CSAElement, 281
  - gdcm::DataElement, 313
- GetCalledAETitle
  - gdcm::network::AAssociateRQPDU, 99
  - gdcm::network::ULConnectionInfo, 1239
  - gdcm::ServiceClassUser, 985
- GetCalledComputerName
  - gdcm::network::ULConnectionInfo, 1239
- GetCalledIPAddress
  - gdcm::network::ULConnectionInfo, 1239
- GetCalledIPPort
  - gdcm::network::ULConnectionInfo, 1239
- GetCallingAETitle
  - gdcm::network::AAssociateRQPDU, 99
  - gdcm::network::ULConnectionInfo, 1239
- GetCenterOfRotation
  - gdcm::Surface, 1063
- GetCharacterFromCurrentLocale
  - gdcm::QueryFactory, 887
- GetCheckFileMetaInformation
  - gdcm::Writer, 1421
- GetCipherType
  - gdcm::CAPICryptographicMessageSyntax, 235
  - gdcm::CryptographicMessageSyntax, 277
  - gdcm::OpenSSLCryptographicMessageSyntax, 757
  - gdcm::OpenSSL7CryptographicMessageSyntax, 762
- GetCodec
  - gdcm::FileChangeTransferSyntax, 458
- GetColorLevel
  - vtkImageColorViewer, 1370
- GetColorWindow
  - vtkImageColorViewer, 1371
- GetColumns
  - gdcm::Bitmap, 198
  - gdcm::Overlay, 771
- GetCommand
  - gdcm::Subject, 1058
- GetConnectionInfo
  - gdcm::network::ULConnection, 1232
- GetConstructorString
  - gdcm::Dicts, 378
- GetContourReferencedFrameOfReferenceClassUID
  - vtkRTStructSetProperties, 1407
- GetContourReferencedFrameOfReferenceInstanceUID
  - vtkRTStructSetProperties, 1407
- GetCryptographicMessageSyntax
  - gdcm::Anonymizer, 115
- GetCSADataInfo
  - gdcm::CSAHeader, 289
- GetCSAEEnd
  - gdcm::CSAHeader, 289
- GetCSAElementByName
  - gdcm::CSAHeader, 289
- GetCSAHeaderDict
  - gdcm::Dicts, 378
- GetCSAHeaderDictEntry
  - gdcm::CSAHeaderDict, 294
- GetCSAImageHeaderInfoTag
  - gdcm::CSAHeader, 290
- GetCSASeriesHeaderInfoTag
  - gdcm::CSAHeader, 290
- GetCTImageSeriesUIDs
  - gdcm::DirectoryHelper, 390
- GetCurrentByteIndex
  - gdcm::Parser, 782
- GetCurrentDateTime
  - gdcm::System, 1091
- GetCurrentModuleFileName
  - gdcm::System, 1092
- GetCurrentProcessFileName
  - gdcm::System, 1092
- GetCurrentResourcesDirectory
  - gdcm::System, 1092
- GetCurve
  - gdcm::Pixmap, 821, 822
- GetCurveDataDescriptor
  - gdcm::Curve, 305
- GetCWD
  - gdcm::System, 1092
- GetData
  - gdcm::DataEvent, 326
- GetDataElement
  - gdcm::Bitmap, 198, 199
  - gdcm::DataSet, 333
  - gdcm::Item, 613
- GetDataExtraRoot
  - gdcm::Testing, 1121
- GetDataLength
  - gdcm::DataEvent, 326
- GetDataRoot
  - gdcm::Testing, 1121
- GetDataSet
  - gdcm::CSAHeader, 290
  - gdcm::DataSetEvent, 343
  - gdcm::File, 450

- GetDataSetPos
  - gdcm::network::ULEvent, [1249](#)
- GetDataSets
  - gdcm::network::ULBasicCallback, [1228](#)
- GetDataSetTransferSyntax
  - gdcm::FileMetaInformation, [474](#)
- GetDataValueRepresentation
  - gdcm::Curve, [305](#)
- GetDebugFlag
  - gdcm::Trace, [1129](#)
- GetDebugStream
  - gdcm::Trace, [1129](#)
- GetDecodeLength
  - gdcm::Base64, [170](#)
- GetDEEnd
  - gdcm::DataSet, [333](#)
- GetDefaultTransferSyntax
  - gdcm::PresentationContextGenerator, [854](#)
- GetDefs
  - gdcm::Global, [512](#)
  - gdcm::TableReader, [1101](#)
- GetDES
  - gdcm::DataSet, [334](#)
- GetDescription
  - gdcm::CSAHeaderDictEntry, [297](#)
  - gdcm::Exception, [439](#)
  - gdcm::ModuleEntry, [710](#)
  - gdcm::Overlay, [771](#)
- GetDescriptiveName
  - vtkGDCMImageReader, [1302](#)
  - vtkGDCMImageReader2, [1316](#)
  - vtkGDCMImageWriter, [1330](#)
- GetDict
  - gdcm::XMLDictReader, [1426](#)
- GetDictEntry
  - gdcm::Dict, [361](#)
  - gdcm::Dicts, [378](#)
  - gdcm::PrivateDict, [870](#)
- GetDictEntryByKeyword
  - gdcm::Dict, [362](#)
- GetDictEntryByName
  - gdcm::Dict, [362](#)
- GetDictName
  - gdcm::DictConverter, [366](#)
- GetDicts
  - gdcm::Global, [512](#), [513](#)
- GetDictVM
  - gdcm::Attribute< Group, Element, TVR, TVM >, [137](#)
  - gdcm::Attribute< Group, Element, TVR, VM::VM1 >, [147](#)
  - gdcm::Attribute< Group, Element, TVR, VM::VM1\_n >, [156](#)
- GetDictVR
  - gdcm::Attribute< Group, Element, TVR, TVM >, [138](#)
- gdcm::Attribute< Group, Element, TVR, VM::VM1 >, [147](#)
- gdcm::Attribute< Group, Element, TVR, VM::VM1\_n >, [156](#)
- GetDimension
  - gdcm::Bitmap, [199](#)
- GetDimensions
  - gdcm::Bitmap, [199](#)
  - gdcm::Curve, [306](#)
  - gdcm::ImageCodec, [555](#)
- GetDimensionsValue
  - gdcm::ImageHelper, [569](#)
- GetDimensionsValueForResolution
  - gdcm::StreamImageReader, [1027](#)
- GetDirectionCosines
  - gdcm::Image, [528](#)
- GetDirectionCosinesFromDataSet
  - gdcm::ImageHelper, [569](#)
- GetDirectionCosinesTolerance
  - gdcm::IPPSorter, [607](#)
- GetDirectionCosinesValue
  - gdcm::ImageHelper, [569](#)
- GetDirectories
  - gdcm::Directory, [388](#)
- GetElapsedTime
  - gdcm::network::ARTIMTimer, [129](#)
- GetElement
  - gdcm::Tag, [1108](#)
- GetElementTag
  - gdcm::Tag, [1108](#)
- GetEncodeLength
  - gdcm::Base64, [170](#)
- GetErrorCode
  - gdcm::Parser, [782](#)
- GetErrorFlag
  - gdcm::Trace, [1129](#)
- GetErrorStream
  - gdcm::Trace, [1129](#)
- GetErrorString
  - gdcm::Parser, [783](#)
- GetEvent
  - gdcm::network::ULEvent, [1249](#)
- GetEventName
  - gdcm::AnonymizeEvent, [109](#)
  - gdcm::DataEvent, [326](#)
  - gdcm::DataSetEvent, [343](#)
  - gdcm::Event, [436](#)
  - gdcm::FileNameEvent, [486](#)
  - gdcm::ProgressEvent, [877](#)
- GetExtension
  - gdcm::Filename, [481](#)
- GetFactoryInstance
  - gdcm::CryptoFactory, [274](#)
- GetFile

- gdcm::Anonymizer, 115
- gdcm::DICOMDIRGenerator, 357
- gdcm::FileDecompressLookupTable, 462
- gdcm::FileDerivation, 465
- gdcm::FileExplicitFilter, 468
- gdcm::IconImageFilter, 519
- gdcm::PythonFilter, 882
- gdcm::Reader, 905
- gdcm::SplitMosaicFilter, 1021
- gdcm::StreamImageReader, 1027
- gdcm::StringFilter, 1052
- gdcm::Writer, 1421
- vtkGDCMMedicalImageProperties, 1339
- GetFileExtensions
  - vtkGDCMImageReader, 1302
  - vtkGDCMImageReader2, 1316
  - vtkGDCMImageWriter, 1331
- GetFileMetaInformationVersion
  - gdcm::FileMetaInformation, 474
- GetFileName
  - gdcm::Filename, 481
  - gdcm::FileNameEvent, 486
  - gdcm::Testing, 1122
  - vtkGDCMImageWriter, 1331
  - vtkGDCMThreadedImageReader2, 1360
- GetFilename
  - gdcm::FilenameGenerator, 489
  - gdcm::TableReader, 1101
- GetFilenameFromTagToValue
  - gdcm::Scanner, 932
  - gdcm::StrictScanner, 1041
- GetFileNames
  - gdcm::Testing, 1122
- GetFilenames
  - gdcm::Directory, 388
  - gdcm::FilenameGenerator, 489
  - gdcm::Scanner, 932
  - gdcm::Sorter, 1013
  - gdcm::StrictScanner, 1041
- GetFilenamesFromSeriesUIDs
  - gdcm::DirectoryHelper, 390
- GetFiles
  - gdcm::FileSet, 492
- GetFiniteVolume
  - gdcm::Surface, 1064
- GetFirstSingleSerieUIDFileSet
  - gdcm::SerieHelper, 977
- GetForcePixelSpacing
  - gdcm::ImageHelper, 569
- GetForceRescaleInterceptSlope
  - gdcm::ImageHelper, 569
- GetFormat
  - gdcm::CSAHeader, 291
- GetFragBuffer
  - gdcm::SequenceOfFragments, 961
- GetFragment
  - gdcm::SequenceOfFragments, 961
- GetFragmentSizeMax
  - gdcm::ImageFragmentSplitter, 566
- GetFrameOfReference
  - gdcm::DirectoryHelper, 391
- GetFullLength
  - gdcm::FileMetaInformation, 474
- GetGDCMDataRoot
  - vtkGDCMTesting, 1352
- GetGDCMImplementationClassUID
  - gdcm::FileMetaInformation, 474
- GetGDCMImplementationVersionName
  - gdcm::FileMetaInformation, 474
- GetGDCMSourceApplicationEntityTitle
  - gdcm::FileMetaInformation, 475
- GetGDCMUID
  - gdcm::UIDGenerator, 1148
- GetGroup
  - gdcm::Curve, 306
  - gdcm::Overlay, 771
  - gdcm::Tag, 1109
- GetHasExpired
  - gdcm::network::ARTIMTimer, 130
- GetHeader
  - gdcm::File, 450
- GetHeaderInfo
  - gdcm::ImageCodec, 555
  - gdcm::JPEG12Codec, 618
  - gdcm::JPEG16Codec, 621
  - gdcm::JPEG2000Codec, 626
  - gdcm::JPEG8Codec, 632
  - gdcm::JPEGCodec, 638
  - gdcm::JPEGLSCodec, 646
  - gdcm::PGXCodec, 805
  - gdcm::PNMCodec, 839
  - gdcm::RAWCodec, 901
  - gdcm::RLECodec, 923
- GetHierarchicalSearchTags
  - gdcm::QueryBase, 885
  - gdcm::QueryImage, 889
  - gdcm::QueryPatient, 891
  - gdcm::QuerySeries, 894
  - gdcm::QueryStudy, 896
- GetHighBit
  - gdcm::PixelFormat, 814
- GetHostName
  - gdcm::System, 1092
- GetIconImage
  - gdcm::IconImageFilter, 519
  - gdcm::IconImageGenerator, 522
  - gdcm::Pixmap, 822
  - vtkGDCMImageReader, 1302

- vtkGDCMImageReader2, [1317](#)
- GetIconImagePort
  - vtkGDCMImageReader2, [1317](#)
- GetIE
  - gdcm::IODEntry, [600](#)
- GetImage
  - gdcm::ImageReader, [576](#)
  - gdcm::ImageWriter, [588](#)
  - gdcm::PixmapWriter, [835](#)
  - gdcm::SplitMosaicFilter, [1021](#)
- GetImplementationClassUID
  - gdcm::FileMetaInformation, [475](#)
- GetImplementationVersionName
  - gdcm::FileMetaInformation, [475](#)
- GetIndex
  - gdcm::SwapCode, [1085](#)
  - gdcm::VM, [1284](#)
- GetInitialized
  - gdcm::CAPICryptographicMessageSyntax, [235](#)
- GetInput
  - gdcm::ImageToImageFilter, [584](#)
  - gdcm::PixmapToPixmapFilter, [831](#)
  - vtkImageColorViewer, [1371](#)
- GetInputFilename
  - gdcm::DictConverter, [366](#)
- GetInstance
  - gdcm::Global, [513](#)
- GetIntercept
  - gdcm::Image, [528](#)
  - gdcm::Rescaler, [916](#)
- GetInterfile
  - gdcm::CSAHeader, [291](#)
- GetInternal
  - gdcm::Preamble, [842](#)
- GetIOD
  - gdcm::IODs, [605](#)
  - gdcm::SOPClassUIDToIOD, [1010](#)
- GetIODEntry
  - gdcm::IOD, [598](#)
- GetIODFromFile
  - gdcm::Defs, [349](#)
- GetIODFromSOPClassUID
  - gdcm::SOPClassUIDToIOD, [1010](#)
- GetIODNameFromMediaStorage
  - gdcm::Defs, [349](#)
- GetIODs
  - gdcm::Defs, [349](#)
- GetIsCommand
  - gdcm::network::PresentationDataValue, [861](#)
- GetIsLastFragment
  - gdcm::network::PresentationDataValue, [861](#)
- GetIStream
  - gdcm::network::ULEvent, [1249](#)
- GetItem
  - gdcm::SequenceOfItems, [969](#)
- GetKey
  - gdcm::CSAElement, [281](#)
- GetKeys
  - gdcm::Scanner, [932](#)
  - gdcm::StrictScanner, [1041](#)
- GetKeyword
  - gdcm::DictEntry, [369](#)
- GetKeywordFromTag
  - gdcm::Dict, [362](#)
- GetLabel
  - gdcm::Orientation, [765](#)
- GetLastElement
  - gdcm::ParseException, [778](#)
- GetLastSystemError
  - gdcm::System, [1092](#)
- GetLength
  - gdcm::ByteValue, [226](#)
  - gdcm::CP246ExplicitDataElement, [271](#)
  - gdcm::DataElement, [313](#)
  - gdcm::DataSet, [334](#)
  - gdcm::Element< TVR, TVM >, [397](#)
  - gdcm::Element< TVR, VM::VM1\_n >, [405](#)
  - gdcm::Element< VR::AS, VM::VM5 >, [418](#)
  - gdcm::ExplicitDataElement, [443](#)
  - gdcm::ExplicitImplicitDataElement, [446](#)
  - gdcm::Fragment, [509](#)
  - gdcm::ImplicitDataElement, [594](#)
  - gdcm::Item, [613](#)
  - gdcm::Preamble, [842](#)
  - gdcm::SequenceOfFragments, [961](#)
  - gdcm::SequenceOfItems, [970](#)
  - gdcm::Tag, [1109](#)
  - gdcm::UNExplicitDataElement, [1255](#)
  - gdcm::UNExplicitImplicitDataElement, [1258](#)
  - gdcm::Value, [1271](#)
  - gdcm::VL, [1278](#)
  - gdcm::VM, [1284](#)
  - gdcm::VR, [1290](#)
  - gdcm::VR16ExplicitDataElement, [1295](#)
- GetLocaleCharset
  - gdcm::System, [1093](#)
- GetLossless
  - gdcm::JPEGCodec, [638](#)
  - gdcm::JPEGLSCoDec, [646](#)
- GetLossyFlag
  - gdcm::ImageCodec, [555](#)
- GetLossyFlagFromFile
  - gdcm::Testing, [1122](#)
- GetLUT
  - gdcm::Bitmap, [199](#)
  - gdcm::ImageCodec, [555](#)
  - gdcm::ImageHelper, [570](#)
  - gdcm::LookupTable, [662](#)

- GetLUTDescriptor
  - gdcm::LookupTable, [662](#)
- GetLUTLength
  - gdcm::LookupTable, [663](#)
- GetMacro
  - gdcm::Macros, [672](#)
- GetMacroEntry
  - gdcm::Macro, [669](#)
- GetMacros
  - gdcm::Defs, [350](#)
- GetMajorAxisFromPatientRelativeDirectionCosine
  - gdcm::Orientation, [765](#)
- GetMajorVersion
  - gdcm::Version, [1276](#)
- GetManifold
  - gdcm::Surface, [1064](#)
- GetMapping
  - gdcm::Scanner, [932](#)
  - gdcm::StrictScanner, [1041](#)
- GetMappingFromTagToValue
  - gdcm::Scanner, [933](#)
  - gdcm::StrictScanner, [1041](#)
- GetMappings
  - gdcm::Scanner, [933](#)
  - gdcm::StrictScanner, [1042](#)
- GetMax
  - gdcm::PixelFormat, [814](#)
- GetMaximumLength
  - gdcm::network::MaximumLengthSub, [673](#)
- GetMaximumLengthSub
  - gdcm::network::UserInformation, [1265](#)
- GetMaximumPointDistance
  - gdcm::Surface, [1064](#)
- GetMaxLength
  - gdcm::PersonName, [801](#)
- GetMaxPDULength
  - gdcm::network::ULConnectionInfo, [1239](#)
- GetMaxPDUSize
  - gdcm::network::ULConnection, [1232](#)
- GetMD5DataImage
  - gdcm::Testing, [1122](#)
- GetMD5DataImages
  - gdcm::Testing, [1123](#)
- GetMD5FromBrokenFile
  - gdcm::Testing, [1123](#)
- GetMD5FromFile
  - gdcm::Testing, [1123](#)
- GetMD5MetalImage
  - vtkGDCMTesting, [1352](#)
- GetMeanPointDistance
  - gdcm::Surface, [1064](#)
- GetMediaStorage
  - gdcm::DataSet, [334](#)
  - gdcm::FileMetaInformation, [475](#)
- GetMediaStorageAsString
  - gdcm::FileMetaInformation, [475](#)
- GetMediaStorageDataFile
  - gdcm::Testing, [1123](#)
- GetMediaStorageDataFiles
  - gdcm::Testing, [1123](#)
- GetMediaStorageFromFile
  - gdcm::Testing, [1123](#)
- GetMeshPrimitive
  - gdcm::Surface, [1064](#)
- GetMessageHeader
  - gdcm::network::PresentationDataValue, [861](#)
- GetMetaInformationTS
  - gdcm::FileMetaInformation, [475](#)
- GetMHDMD5FromFile
  - vtkGDCMTesting, [1352](#)
- GetMin
  - gdcm::PixelFormat, [814](#)
- GetMinorVersion
  - gdcm::Version, [1276](#)
- GetModality
  - gdcm::MediaStorage, [682](#)
- GetModalityDimension
  - gdcm::MediaStorage, [682](#)
- GetModule
  - gdcm::Modules, [714](#)
- GetModuleEntry
  - gdcm::NestedModuleEntries, [734](#)
- GetModuleEntryInMacros
  - gdcm::Module, [707](#)
- GetModules
  - gdcm::Defs, [350](#)
- GetMPTType
  - gdcm::MeshPrimitive, [695](#)
- GetMPTTypeString
  - gdcm::MeshPrimitive, [695](#)
- GetMRImageSeriesUIDs
  - gdcm::DirectoryHelper, [391](#)
- GetMrProtocol
  - gdcm::CSAHeader, [291](#)
- GetMrProtocolByName
  - gdcm::MrProtocol, [722](#)
- GetMSString
  - gdcm::MediaStorage, [683](#)
- GetMSType
  - gdcm::MediaStorage, [683](#)
- GetMTime
  - vtkImageMapToColors16, [1384](#)
- GetName
  - gdcm::CSAElement, [281](#)
  - gdcm::CSAHeaderDictEntry, [297](#)
  - gdcm::DictEntry, [370](#)
  - gdcm::Filename, [481](#)
  - gdcm::GroupDict, [516](#)



- gdcM::IODEntry, [601](#)
- gdcM::Macro, [669](#)
- gdcM::Module, [707](#)
- gdcM::ModuleEntry, [711](#)
- gdcM::network::AbstractSyntax, [105](#)
- gdcM::network::ApplicationContext, [120](#)
- gdcM::network::TransferSyntaxSub, [1139](#)
- gdcM::PDBElement, [789](#)
- gdcM::QueryBase, [885](#)
- gdcM::QueryImage, [889](#)
- gdcM::QueryPatient, [891](#)
- gdcM::QuerySeries, [894](#)
- gdcM::QueryStudy, [896](#)
- gdcM::UIDs, [1185](#)
- GetNeedByteSwap
  - gdcM::Bitmap, [200](#)
  - gdcM::ImageCodec, [555](#)
- GetNegotiatedType
  - gdcM::TransferSyntax, [1136](#)
- GetNestedDataSet
  - gdcM::Item, [613](#)
- GetNextSingleSerieUIDFileSet
  - gdcM::SerieHelper, [977](#)
- GetNoOfItems
  - gdcM::CSAElement, [281](#)
- GetNumberOfComponents
  - gdcM::PersonName, [801](#)
- GetNumberOfContourReferencedFrameOfReferences
  - vtkRTStructSetProperties, [1407](#)
- GetNumberOfCurves
  - gdcM::Curve, [306](#)
  - gdcM::Pixmap, [822](#)
- GetNumberOfDimensions
  - gdcM::Bitmap, [200](#)
  - gdcM::ImageCodec, [555](#)
- GetNumberOfElementsFromArray
  - gdcM::VM, [1284](#)
- GetNumberOfFileNames
  - gdcM::Testing, [1124](#)
- GetNumberOfFilenames
  - gdcM::FilenameGenerator, [489](#)
- GetNumberOfFragments
  - gdcM::SequenceOfFragments, [962](#)
- GetNumberOfIconImages
  - gdcM::IconImageFilter, [520](#)
- GetNumberOfImagesInMosaic
  - gdcM::SplitMosaicFilter, [1022](#)
- GetNumberOfIODs
  - gdcM::IOD, [598](#)
- GetNumberOfItems
  - gdcM::SequenceOfItems, [970](#)
- GetNumberOfMD5DataImages
  - gdcM::Testing, [1124](#)
- GetNumberOfMD5MetalImages
  - vtkGDCMTesting, [1352](#)
- GetNumberOfMediaStorageDataFiles
  - gdcM::Testing, [1124](#)
- GetNumberOfModality
  - gdcM::MediaStorage, [683](#)
- GetNumberOfModuleEntries
  - gdcM::NestedModuleEntries, [734](#)
- GetNumberOfMSString
  - gdcM::MediaStorage, [683](#)
- GetNumberOfMSType
  - gdcM::MediaStorage, [683](#)
- GetNumberOfOverlays
  - gdcM::Pixmap, [822](#)
- GetNumberOfPoints
  - gdcM::Curve, [306](#)
- GetNumberOfPresentationContext
  - gdcM::network::AAssociateRQPDU, [100](#)
- GetNumberOfPresentationContextAC
  - gdcM::network::AAssociateACPDU, [92](#)
- GetNumberOfPresentationDataValues
  - gdcM::network::PDataTFPDU, [786](#)
- GetNumberOfPrimitivesData
  - gdcM::MeshPrimitive, [696](#)
- GetNumberOfReferencedFrameOfReferences
  - vtkRTStructSetProperties, [1407](#)
- GetNumberOfSegments
  - gdcM::SegmentWriter, [955](#)
- GetNumberOfSOPClassToIOD
  - gdcM::SOPClassUIDToIOD, [1010](#)
- GetNumberOfStructureSetROIs
  - vtkRTStructSetProperties, [1407](#)
- GetNumberOfSurfacePoints
  - gdcM::Surface, [1065](#)
- GetNumberOfSurfaces
  - gdcM::SurfaceReader, [1079](#)
  - gdcM::SurfaceWriter, [1082](#)
- GetNumberOfTransferSyntaxes
  - gdcM::network::PresentationContextRQ, [857](#)
  - gdcM::PresentationContext, [847](#)
- GetNumberOfTransferSyntaxStrings
  - gdcM::UIDs, [1185](#)
- GetNumberOfValues
  - gdcM::Attribute< Group, Element, TVR, TVM >, [138](#)
  - gdcM::Attribute< Group, Element, TVR, VM::VM1 >, [147](#)
  - gdcM::Attribute< Group, Element, TVR, VM::VM1\_n >, [156](#)
- GetNumberOfVectors
  - gdcM::Surface, [1065](#)
- GetObliquityThresholdCosineValue
  - gdcM::Orientation, [765](#)
- GetOffScreenRendering
  - vtkImageColorViewer, [1371](#)
- GetOptionalTags



- gdcM::QueryBase, 885
- gdcM::QueryImage, 889
- gdcM::QueryPatient, 892
- gdcM::QuerySeries, 894
- gdcM::QueryStudy, 897
- GetOrderedValues
  - gdcM::Scanner, 933
  - gdcM::StrictScanner, 1042
- GetOrigin
  - gdcM::Image, 528
  - gdcM::Overlay, 771
- GetOriginValue
  - gdcM::ImageHelper, 570
- GetOutput
  - gdcM::ImageConverter, 563
- GetOutput
  - gdcM::BitmapToBitmapFilter, 211
  - gdcM::ImageToImageFilter, 584
  - gdcM::PixmapToPixmapFilter, 831
- GetOutputAsBitmap
  - gdcM::BitmapToBitmapFilter, 211
- GetOutputAsPixmap
  - gdcM::PixmapToPixmapFilter, 831
- GetOutputFilename
  - gdcM::DictConverter, 366
- GetOutputType
  - gdcM::DictConverter, 366
- GetOverlay
  - gdcM::Pixmap, 822, 823
  - vtkGDCMImageReader, 1302
  - vtkGDCMImageReader2, 1317
- GetOverlayData
  - gdcM::Overlay, 771
- GetOverlayPort
  - vtkGDCMImageReader2, 1317
- GetOverlayTypeAsString
  - gdcM::Overlay, 771
- GetOverlayTypeFromString
  - gdcM::Overlay, 772
- GetOverlayVisibility
  - vtkImageColorViewer, 1371
- GetOwner
  - gdcM::PrivateTag, 873
- GetPath
  - gdcM::Filename, 481
- GetPattern
  - gdcM::FilenameGenerator, 490
- GetPDBEEnd
  - gdcM::PDBHeader, 793
- GetPDBElementByName
  - gdcM::PDBHeader, 793
- GetPDBInfoTag
  - gdcM::PDBHeader, 793
- GetPDUs
  - gdcM::network::ULEvent, 1249
- GetPDVs
  - gdcM::network::PDUFactory, 800
- GetPermissions
  - gdcM::System, 1093
- GetPhotometricInterpretation
  - gdcM::Bitmap, 200
  - gdcM::ImageChangePhotometricInterpretation, 538
  - gdcM::ImageCodec, 556
- GetPhotometricInterpretationValue
  - gdcM::ImageHelper, 570
- GetPIString
  - gdcM::PhotometricInterpretation, 808
- GetPIType
  - gdcM::PhotometricInterpretation, 808
- GetPixelFormat
  - gdcM::Bitmap, 200, 201
  - gdcM::ImageCodec, 556
- GetPixelFormatValue
  - gdcM::ImageHelper, 570
- GetPixelRepresentation
  - gdcM::PixelFormat, 814
- GetPixelSize
  - gdcM::PixelFormat, 814
- GetPixelSpacingDataRoot
  - gdcM::Testing, 1124
- GetPixmap
  - gdcM::FileDecompressLookupTable, 462
  - gdcM::IconImageGenerator, 523
  - gdcM::PixmapReader, 827
  - gdcM::PixmapWriter, 835
- GetPlanarConfiguration
  - gdcM::Bitmap, 201
  - gdcM::ImageChangePlanarConfiguration, 541
  - gdcM::ImageCodec, 556
- GetPlanarConfigurationValue
  - gdcM::ImageHelper, 570
- GetPMSRescaleInterceptSlope
  - gdcM::ImageHelper, 570
- GetPointCoordinatesData
  - gdcM::Surface, 1065
- GetPointer
  - gdcM::ByteValue, 227
  - gdcM::LookupTable, 663
  - gdcM::SmartPointer< ObjectType >, 1005
  - vtkLookupTable16, 1401
- GetPointerFromElement
  - gdcM::ImageHelper, 571
- GetPointPositionAccuracy
  - gdcM::Surface, 1065
- GetPointsBoundingBoxCoordinates
  - gdcM::Surface, 1065
- GetPosition
  - vtkImageColorViewer, 1371

- GetPreamble
  - gdcm::FileMetaInformation, [475](#), [476](#)
- GetPrefix
  - gdcm::FilenameGenerator, [490](#)
- GetPresentationContext
  - gdcm::network::AAssociateRQPDU, [100](#)
- GetPresentationContextAC
  - gdcm::network::AAssociateACPDU, [92](#)
- GetPresentationContextACByID
  - gdcm::network::ULConnection, [1232](#)
- GetPresentationContextByAbstractSyntax
  - gdcm::network::AAssociateRQPDU, [100](#)
- GetPresentationContextByID
  - gdcm::network::AAssociateRQPDU, [100](#)
- GetPresentationContextID
  - gdcm::network::PresentationContextAC, [850](#)
  - gdcm::network::PresentationContextRQ, [857](#)
  - gdcm::network::PresentationDataValue, [861](#)
  - gdcm::PresentationContext, [847](#)
- GetPresentationContextIDFromPresentationContext
  - gdcm::network::ULConnection, [1232](#)
- GetPresentationContextRQByID
  - gdcm::network::ULConnection, [1232](#)
- GetPresentationContexts
  - gdcm::network::AAssociateRQPDU, [100](#)
  - gdcm::network::ULConnection, [1233](#)
  - gdcm::PresentationContextGenerator, [854](#)
- GetPresentationDataValue
  - gdcm::network::PDataTFPDU, [787](#)
- GetPrettyPrint
  - gdcm::JSON, [649](#)
- GetPrimitiveData
  - gdcm::MeshPrimitive, [696](#)
- GetPrimitivesData
  - gdcm::MeshPrimitive, [696](#)
- GetPrimitiveType
  - gdcm::MeshPrimitive, [697](#)
- GetPrintStyle
  - gdcm::Printer, [866](#)
  - gdcm::XMLPrinter, [1429](#)
- GetPrivateCreator
  - gdcm::DataSet, [334](#)
  - gdcm::Tag, [1109](#)
- GetPrivateDict
  - gdcm::Dicts, [378](#), [379](#)
  - gdcm::XMLPrivateDictReader, [1433](#)
- GetProcessingAlgorithm
  - gdcm::Surface, [1066](#)
- GetProgress
  - gdcm::ProgressEvent, [877](#)
- GetPropertyCategory
  - gdcm::Segment, [940](#)
- GetPropertyType
  - gdcm::Segment, [940](#), [941](#)
- GetPropertyTypeModifiers
  - gdcm::Segment, [941](#)
- GetProtocol
  - gdcm::network::ULConnection, [1233](#)
- GetPublicDict
  - gdcm::Dicts, [379](#)
- GetQuality
  - gdcm::JPEG2000Codec, [626](#)
  - gdcm::JPEGCodec, [638](#)
- GetQueryDataSet
  - gdcm::BaseQuery, [180](#)
- GetQueryLevel
  - gdcm::QueryBase, [885](#)
  - gdcm::QueryImage, [889](#)
  - gdcm::QueryPatient, [892](#)
  - gdcm::QuerySeries, [894](#)
  - gdcm::QueryStudy, [897](#)
- GetQueryLevelFromQueryRoot
  - gdcm::BaseRootQuery, [185](#)
- GetQueryLevelFromString
  - gdcm::BaseRootQuery, [185](#)
- GetQueryLevelString
  - gdcm::BaseRootQuery, [185](#)
- GetRate
  - gdcm::JPEG2000Codec, [627](#)
- GetRAWMD5FromFile
  - vtkGDCMTesting, [1353](#)
- GetRealWorldValueMappingContent
  - gdcm::ImageHelper, [571](#)
- GetReason
  - gdcm::network::PresentationContextAC, [850](#)
- GetRecommendedDisplayCIELabValue
  - gdcm::Surface, [1066](#)
- GetRecommendedDisplayGrayscaleValue
  - gdcm::Surface, [1066](#)
- GetRecommendedPresentationOpacity
  - gdcm::Surface, [1066](#)
- GetRecommendedPresentationType
  - gdcm::Surface, [1067](#)
- GetRef
  - gdcm::IODEntry, [601](#)
- GetReferencedFrameOfReferenceClassUID
  - vtkRTStructSetProperties, [1408](#)
- GetReferencedFrameOfReferenceInstanceUID
  - vtkRTStructSetProperties, [1408](#)
- GetRegion
  - gdcm::ImageRegionReader, [581](#)
- GetRequiredDataSet
  - gdcm::ModalityPerformedProcedureStepCreateQuery, [700](#)
  - gdcm::ModalityPerformedProcedureStepSetQuery, [703](#)
- GetRequiredTags
  - gdcm::QueryBase, [885](#)

- gdcm::QueryImage, [890](#)
- gdcm::QueryPatient, [892](#)
- gdcm::QuerySeries, [894](#)
- gdcm::QueryStudy, [897](#)
- GetRescaleInterceptSlopeValue
  - gdcm::ImageHelper, [571](#)
- GetReserved43\_74
  - gdcm::network::AAssociateRQPDU, [100](#)
- GetResponses
  - gdcm::network::ULBasicCallback, [1228](#)
- GetRetired
  - gdcm::DictEntry, [370](#)
- GetRoot
  - gdcm::UIDGenerator, [1148](#)
- GetRows
  - gdcm::Bitmap, [201](#)
  - gdcm::Overlay, [772](#)
- GetRTStructSeriesUIDs
  - gdcm::DirectoryHelper, [391](#)
- GetSamplesPerPixel
  - gdcm::PhotometricInterpretation, [809](#)
  - gdcm::PixelFormat, [815](#)
- GetScalarType
  - gdcm::PixelFormat, [815](#)
- GetScalarTypeAsString
  - gdcm::PixelFormat, [815](#)
- GetScanner
  - gdcm::DICOMDIRGenerator, [358](#)
- GetSegment
  - gdcm::SegmentWriter, [955](#)
- GetSegmentAlgorithmName
  - gdcm::Segment, [941](#)
- GetSegmentAlgorithmType
  - gdcm::Segment, [941](#)
- GetSegmentDescription
  - gdcm::Segment, [941](#)
- GetSegmentLabel
  - gdcm::Segment, [941](#)
- GetSegmentNumber
  - gdcm::Segment, [942](#)
- GetSegments
  - gdcm::SegmentReader, [951](#)
  - gdcm::SegmentWriter, [955](#)
- GetSelectedPrivateGroupOffsetFromFile
  - gdcm::Testing, [1124](#)
- GetSelectedTagsOffsetFromFile
  - gdcm::Testing, [1125](#)
- GetSequenceOfFragments
  - gdcm::DataElement, [314](#)
- GetSeriesUIDsBySOPClassUID
  - gdcm::DirectoryHelper, [391](#)
- GetSize
  - gdcm::VR, [1290](#)
  - vtkImageColorViewer, [1371](#)
- GetSizeof
  - gdcm::VR, [1290](#)
- GetSliceArray
  - gdcm::MrProtocol, [722](#)
- GetSliceMax
  - vtkImageColorViewer, [1371](#)
- GetSliceMin
  - vtkImageColorViewer, [1372](#)
- GetSliceRange
  - vtkImageColorViewer, [1372](#)
- GetSlope
  - gdcm::Image, [529](#)
  - gdcm::Rescaler, [916](#)
- GetSOPClassUID
  - gdcm::DirectoryHelper, [391](#)
- GetSOPClassUIDFromIOD
  - gdcm::SOPClassUIDToIOD, [1010](#)
- GetSOPClassUIDToIOD
  - gdcm::SOPClassUIDToIOD, [1010](#)
- GetSOPClassUIDToIODs
  - gdcm::SOPClassUIDToIOD, [1010](#)
- GetSOPInstanceUID
  - gdcm::BaseQuery, [180](#)
- GetSourceApplicationEntityTitle
  - gdcm::FileMetaInformation, [476](#)
- GetSourceDirectory
  - gdcm::Testing, [1125](#)
- GetSpacing
  - gdcm::Image, [529](#)
- GetSpacingTagFromMediaStorage
  - gdcm::ImageHelper, [571](#)
- GetSpacingValue
  - gdcm::ImageHelper, [571](#)
- GetStart
  - gdcm::ByteBuffer, [218](#)
- GetState
  - gdcm::network::ULConnection, [1233](#)
- GetStateIndex
  - gdcm::network, [83](#)
- GetSTATES
  - gdcm::Surface, [1067](#)
- GetSTATESString
  - gdcm::Surface, [1067](#)
- GetStream
  - gdcm::Trace, [1130](#)
- GetStreamCurrentPosition
  - gdcm::Reader, [906](#)
- GetStreamOffsetFromFile
  - gdcm::Testing, [1125](#)
- GetStreamPtr
  - gdcm::Reader, [906](#)
  - gdcm::Writer, [1422](#)
- GetString
  - gdcm::MediaStorage, [684](#)

- gdcM::PhotometricInterpretation, 809
- gdcM::TransferSyntax, 1136
- gdcM::UIDs, 1185
- GetStringValueFromTag
  - gdcM::DirectoryHelper, 392
- GetStructureSetObservationNumber
  - vtkRTStructSetProperties, 1408
- GetStructureSetROIDescription
  - vtkRTStructSetProperties, 1408
- GetStructureSetROIGenerationAlgorithm
  - vtkRTStructSetProperties, 1408
- GetStructureSetROIName
  - vtkRTStructSetProperties, 1408
- GetStructureSetROINumber
  - vtkRTStructSetProperties, 1409
- GetStructureSetROIObservationLabel
  - vtkRTStructSetProperties, 1409
- GetStructureSetROIRefFrameRefUID
  - vtkRTStructSetProperties, 1409
- GetStructureSetRTROIInterpretedType
  - vtkRTStructSetProperties, 1409
- GetSurface
  - gdcM::Segment, 942
- GetSurfaceComments
  - gdcM::Surface, 1067
- GetSurfaceCount
  - gdcM::Segment, 942
- GetSurfaceNumber
  - gdcM::Surface, 1067
- GetSurfaceProcessing
  - gdcM::Surface, 1067
- GetSurfaceProcessingDescription
  - gdcM::Surface, 1067
- GetSurfaceProcessingRatio
  - gdcM::Surface, 1068
- GetSurfaces
  - gdcM::Segment, 942
- GetSwapCode
  - gdcM::TransferSyntax, 1136
- GetSwapCodeString
  - gdcM::SwapCode, 1085
- GetSyngoDT
  - gdcM::CSAElement, 281
- GetTable
  - gdcM::SequenceOfFragments, 962
- GetTableEntry
  - gdcM::Table, 1097
- GetTag
  - gdcM::AnonymizeEvent, 109
  - gdcM::Attribute< Group, Element, TVR, TVM >, 138
  - gdcM::Attribute< Group, Element, TVR, VM::VM1 >, 147
  - gdcM::Attribute< Group, Element, TVR, VM::VM1\_n >, 156
  - gdcM::DataElement, 314
- GetTagListByLevel
  - gdcM::BaseRootQuery, 186
  - gdcM::FindPatientRootQuery, 502
  - gdcM::FindStudyRootQuery, 505
  - gdcM::MovePatientRootQuery, 716
  - gdcM::MoveStudyRootQuery, 719
  - gdcM::WLMFindQuery, 1417
- GetTempDirectory
  - gdcM::Testing, 1125
- GetTempDirectoryW
  - gdcM::Testing, 1125
- GetTempFilename
  - gdcM::Testing, 1126
- GetTempFilenameW
  - gdcM::Testing, 1126
- GetTimeout
  - gdcM::network::ARTIMTimer, 130
  - gdcM::ServiceClassUser, 985
- GetTimer
  - gdcM::network::ULConnection, 1233
- GetTimezoneOffsetFromUTC
  - gdcM::System, 1093
- GetToplevel
  - gdcM::Directory, 388
- GetTransferSyntax
  - gdcM::Bitmap, 201
  - gdcM::ImageChangeTransferSyntax, 546
  - gdcM::network::PresentationContextAC, 850
  - gdcM::network::PresentationContextRQ, 857
  - gdcM::PresentationContext, 847
- GetTransferSyntaxes
  - gdcM::network::PresentationContextRQ, 858
- GetTransferSyntaxString
  - gdcM::UIDs, 1185
- GetTransferSyntaxStrings
  - gdcM::UIDs, 1185
- GetTSString
  - gdcM::TransferSyntax, 1136
- GetTSType
  - gdcM::TransferSyntax, 1137
- GetType
  - gdcM::ModuleEntry, 711
  - gdcM::Orientation, 765
  - gdcM::Overlay, 772
  - gdcM::PhotometricInterpretation, 809
- GetTypeAsEnum
  - gdcM::Overlay, 772
- GetTypeFromTag
  - gdcM::Defs, 350
  - gdcM::IOD, 599
- GetTypeOfData
  - gdcM::Curve, 306
- GetTypeOfDataDescription

- gdcM::Curve, 306
- GetTypeString
  - gdcM::Type, 1145
- GetTypeType
  - gdcM::Type, 1145
- GetUIDName
  - gdcM::UIDs, 1186
- GetUIDString
  - gdcM::UIDs, 1186
- GetUniqueTags
  - gdcM::QueryBase, 886
  - gdcM::QueryImage, 890
  - gdcM::QueryPatient, 892
  - gdcM::QuerySeries, 895
  - gdcM::QueryStudy, 897
- GetUnpackBuffer
  - gdcM::Overlay, 772
- GetUnpackBufferLength
  - gdcM::Overlay, 772
- GetUsage
  - gdcM::IODEntry, 601
- GetUsageString
  - gdcM::Usage, 1262
- GetUsageType
  - gdcM::IODEntry, 601
  - gdcM::Usage, 1262
- GetUserData
  - gdcM::Parser, 783
- GetUserInformation
  - gdcM::network::AAssociateACPDU, 92
  - gdcM::network::AAssociateRQPDU, 101
- GetValidatedFile
  - gdcM::Validate, 1268
- GetValidDataSet
  - gdcM::WLMFindQuery, 1417
- GetValue
  - gdcM::Attribute< Group, Element, TVR, TVM >, 138, 139
  - gdcM::Attribute< Group, Element, TVR, VM::VM1 >, 147
  - gdcM::Attribute< Group, Element, TVR, VM::VM1\_n >, 156
  - gdcM::CSAElement, 282
  - gdcM::DataElement, 314, 315
  - gdcM::Element< TVR, TVM >, 398
  - gdcM::Element< TVR, VM::VM1\_n >, 405
  - gdcM::PDBelement, 790
  - gdcM::Scanner, 933
  - gdcM::StrictScanner, 1042
- GetValueAsSQ
  - gdcM::DataElement, 315
- GetValues
  - gdcM::Attribute< Group, Element, TVR, TVM >, 139
- gdcM::Attribute< Group, Element, TVR, VM::VM1 >, 148
- gdcM::Attribute< Group, Element, TVR, VM::VM1\_n >, 157
- gdcM::Element< TVR, TVM >, 398
- gdcM::Scanner, 933, 934
- gdcM::StrictScanner, 1042
- GetVectorAccuracy
  - gdcM::Surface, 1068
- GetVectorCoordinateData
  - gdcM::Surface, 1068
- GetVectorDimensionality
  - gdcM::Surface, 1068
- GetVersion
  - gdcM::MrProtocol, 722
  - gdcM::Version, 1276
- GetVIEWType
  - gdcM::Surface, 1068
- GetVIEWTypeString
  - gdcM::Surface, 1068
- GetVL
  - gdcM::DataElement, 315, 316
- GetVL16Max
  - gdcM::VL, 1278
- GetVL32Max
  - gdcM::VL, 1279
- GetVM
  - gdcM::Attribute< Group, Element, TVR, TVM >, 139
  - gdcM::Attribute< Group, Element, TVR, VM::VM1 >, 148
  - gdcM::Attribute< Group, Element, TVR, VM::VM1\_3 >, 151
  - gdcM::Attribute< Group, Element, TVR, VM::VM1\_8 >, 153
  - gdcM::Attribute< Group, Element, TVR, VM::VM1\_n >, 157
  - gdcM::Attribute< Group, Element, TVR, VM::VM2\_2n >, 161
  - gdcM::Attribute< Group, Element, TVR, VM::VM2\_n >, 162
  - gdcM::Attribute< Group, Element, TVR, VM::VM3\_3n >, 164
  - gdcM::Attribute< Group, Element, TVR, VM::VM3\_n >, 165
  - gdcM::CSAElement, 282
  - gdcM::CSAHeaderDictEntry, 297
  - gdcM::DictEntry, 370
  - gdcM::Element< TVR, TVM >, 398
  - gdcM::Element< TVR, VM::VM1\_n >, 405
- GetVMString
  - gdcM::VM, 1284
- GetVMType
  - gdcM::VM, 1285
- GetVMTypeFromLength

- gdcM::VM, [1285](#)
- GetVoidPointer
  - gdcM::ByteValue, [227](#)
- GetVR
  - gdcM::Attribute< Group, Element, TVR, TVM >, [139](#)
  - gdcM::Attribute< Group, Element, TVR, VM::VM1 >, [148](#)
  - gdcM::Attribute< Group, Element, TVR, VM::VM1\_n >, [157](#)
  - gdcM::CSAElement, [282](#)
  - gdcM::CSAHeaderDictEntry, [297](#)
  - gdcM::DataElement, [316](#)
  - gdcM::DictEntry, [370](#)
  - gdcM::Element< TVR, TVM >, [398](#)
  - gdcM::Element< TVR, VM::VM1\_n >, [405](#)
- GetVRFromTag
  - gdcM, [64](#)
- GetVRString
  - gdcM::VR, [1290](#)
- GetVRStringFromFile
  - gdcM::VR, [1291](#)
- GetVRType
  - gdcM::VR, [1291](#)
- GetVRTypeFromFile
  - gdcM::VR, [1291](#)
- GetVTKDataRoot
  - vtkGDCMTesting, [1353](#)
- GetWarningFlag
  - gdcM::Trace, [1130](#)
- GetWarningStream
  - gdcM::Trace, [1130](#)
- GetWindowName
  - vtkImageColorViewer, [1372](#)
- GetXMax
  - gdcM::BoxRegion, [215](#)
- GetXMin
  - gdcM::BoxRegion, [215](#)
- GetYMax
  - gdcM::BoxRegion, [216](#)
- GetYMin
  - gdcM::BoxRegion, [216](#)
- GetZMax
  - gdcM::BoxRegion, [216](#)
- GetZMin
  - gdcM::BoxRegion, [216](#)
- GetZSpacing
  - gdcM::IPPSorter, [607](#)
- GetZSpacingTagFromMediaStorage
  - gdcM::ImageHelper, [572](#)
- GetZSpacingTolerance
  - gdcM::IPPSorter, [608](#)
- Global
  - gdcM::Defs, [351](#)
  - gdcM::Dicts, [379](#)
  - gdcM::Global, [511](#), [512](#)
- GlobalInstance
  - gdcM, [76](#)
- GrabOverlayFromPixelData
  - gdcM::Overlay, [773](#)
- Graphics
  - gdcM::Overlay, [769](#)
- GRAY
  - gdcM::LookupTable, [660](#)
- GrayscalePlanarMPRVolumetricPresentationStateStorage
  - gdcM::UIDs, [1173](#)
- GrayscaleSoftcopyPresentationStateStorageSOPClass
  - gdcM::MediaStorage, [680](#)
  - gdcM::UIDs, [1169](#)
- GREEN
  - gdcM::LookupTable, [660](#)
- green
  - gdcM::terminal, [85](#)
- GroupDict
  - gdcM::GroupDict, [515](#)
- GroupStringVector
  - gdcM::GroupDict, [515](#)
- GuessFromModality
  - gdcM::MediaStorage, [684](#)
- HandleBulkData
  - gdcM::XMLPrinter, [1429](#)
- HandleDataSet
  - gdcM::network::ULBasicCallback, [1229](#)
  - gdcM::network::ULConnectionCallback, [1237](#)
  - gdcM::network::ULWritingCallback, [1253](#)
- HandleDescription
  - gdcM::XMLDictReader, [1426](#)
  - gdcM::XMLPrivateDictReader, [1433](#)
- HandleEntry
  - gdcM::XMLDictReader, [1426](#)
  - gdcM::XMLPrivateDictReader, [1433](#)
- HandleEvent
  - gdcM::network::ULTransitionTable, [1251](#)
- HandleIOD
  - gdcM::TableReader, [1102](#)
- HandleIOEntry
  - gdcM::TableReader, [1102](#)
- HandleMacro
  - gdcM::TableReader, [1102](#)
- HandleMacroEntry
  - gdcM::TableReader, [1102](#)
- HandleMacroEntryDescription
  - gdcM::TableReader, [1102](#)
- HandleModule
  - gdcM::TableReader, [1102](#)
- HandleModuleEntry
  - gdcM::TableReader, [1103](#)
- HandleModuleEntryDescription

- gdcM::TableReader, [1103](#)
- HandleModuleInclude
  - gdcM::TableReader, [1103](#)
- HandleResponse
  - gdcM::network::ULBasicCallback, [1229](#)
  - gdcM::network::ULConnectionCallback, [1237](#)
  - gdcM::network::ULWritingCallback, [1253](#)
- HangingProtocolInformationModelFIND
  - gdcM::UIDs, [1171](#)
- HangingProtocolInformationModelGET
  - gdcM::UIDs, [1175](#)
- HangingProtocolInformationModelMOVE
  - gdcM::UIDs, [1171](#)
- HangingProtocolStorage
  - gdcM::MediaStorage, [681](#)
  - gdcM::UIDs, [1171](#)
- HardcopyColorImageStorage
  - gdcM::MediaStorage, [681](#)
- HardcopyColorImageStorageSOPClassRetired
  - gdcM::UIDs, [1168](#)
- HardcopyGrayscaleImageStorage
  - gdcM::MediaStorage, [680](#)
- HardcopyGrayscaleImageStorageSOPClassRetired
  - gdcM::UIDs, [1168](#)
- HasObserver
  - gdcM::Subject, [1058](#)
- HemodynamicWaveformStorage
  - gdcM::MediaStorage, [680](#)
  - gdcM::UIDs, [1169](#)
- HEVCH\_265Main10ProfileLevel5\_1
  - gdcM::UIDs, [1173](#)
- HEVCH\_265MainProfileLevel5\_1
  - gdcM::UIDs, [1173](#)
- hidden
  - gdcM::terminal, [85](#)
- HITACHI
  - gdcM::EquipmentManufacturer, [433](#)
- HotIronColorPaletteSOPInstance
  - gdcM::UIDs, [1173](#)
- HotMetalBlueColorPaletteSOPInstance
  - gdcM::UIDs, [1172](#)
- HSV
  - gdcM::PhotometricInterpretation, [808](#)
- ICBM452T1FrameofReference
  - gdcM::UIDs, [1167](#)
- ICBMSingleSubjectMRIFrameofReference
  - gdcM::UIDs, [1167](#)
- ICD11
  - gdcM::UIDs, [1172](#)
- Icon
  - gdcM::Pixmap, [824](#)
- IconDataScalarType
  - vtkGDCMImageReader, [1311](#)
  - vtkGDCMImageReader2, [1325](#)
- IconImage
  - gdcM, [59](#)
- IconImageDataExtent
  - vtkGDCMImageReader, [1311](#)
  - vtkGDCMImageReader2, [1325](#)
- IconImageFilter
  - gdcM::IconImageFilter, [518](#)
- IconImageGenerator
  - gdcM::IconImageGenerator, [521](#)
- IconNumberOfScalarComponents
  - vtkGDCMImageReader, [1311](#)
  - vtkGDCMImageReader2, [1326](#)
- ID
  - gdcM::PresentationContext, [848](#)
- ignore\_char
  - gdcM::ignore\_char, [524](#)
- Image
  - gdcM::Image, [527](#)
- ImageActor
  - vtkImageColorViewer, [1380](#)
- ImageApplyLookupTable
  - gdcM::ImageApplyLookupTable, [534](#)
- ImageBiomarkerStandardisationInitiative
  - gdcM::UIDs, [1172](#)
- ImageChangePhotometricInterpretation
  - gdcM::ImageChangePhotometricInterpretation, [537](#)
  - gdcM::ImageCodec, [560](#)
- ImageChangePlanarConfiguration
  - gdcM::ImageChangePlanarConfiguration, [541](#)
- ImageChangeTransferSyntax
  - gdcM::Bitmap, [207](#)
  - gdcM::ImageChangeTransferSyntax, [545](#)
- ImageCodec
  - gdcM::ImageCodec, [551](#)
- ImageConverter
  - gdcM::ImageConverter, [562](#)
- ImageFormat
  - vtkGDCMImageReader, [1311](#)
  - vtkGDCMImageReader2, [1326](#)
- ImageFragmentSplitter
  - gdcM::ImageFragmentSplitter, [566](#)
- ImageNumberOrdering
  - gdcM::SerieHelper, [977](#)
- ImageOrientationPatient
  - vtkGDCMImageReader, [1311](#)
  - vtkGDCMImageReader2, [1326](#)
- ImageOverlayBoxSOPClassRetired
  - gdcM::UIDs, [1168](#)
- ImagePositionPatient
  - vtkGDCMImageReader, [1311](#)
  - vtkGDCMImageReader2, [1326](#)
- ImagePositionPatientOrdering
  - gdcM::SerieHelper, [977](#)



- ImageReader
  - gdcm::ImageReader, [576](#)
- ImageRegionReader
  - gdcm::ImageRegionReader, [580](#)
  - gdcm::JPEG2000Codec, [629](#)
  - gdcm::JPEGCodec, [641](#)
  - gdcm::JPEGLSCodec, [648](#)
  - gdcm::RLECodec, [924](#)
- ImageToImageFilter
  - gdcm::ImageToImageFilter, [584](#)
- ImageWriter
  - gdcm::ImageWriter, [587](#)
- ImplantAssemblyTemplateInformationModelFIND
  - gdcm::UIDs, [1175](#)
- ImplantAssemblyTemplateInformationModelGET
  - gdcm::UIDs, [1175](#)
- ImplantAssemblyTemplateInformationModelMOVE
  - gdcm::UIDs, [1175](#)
- ImplantAssemblyTemplateStorage
  - gdcm::UIDs, [1175](#)
- ImplantationPlanSRStorage
  - gdcm::UIDs, [1174](#)
- ImplantTemplateGroupInformationModelFIND
  - gdcm::UIDs, [1175](#)
- ImplantTemplateGroupInformationModelGET
  - gdcm::UIDs, [1175](#)
- ImplantTemplateGroupInformationModelMOVE
  - gdcm::UIDs, [1175](#)
- ImplantTemplateGroupStorage
  - gdcm::UIDs, [1175](#)
- ImplementationClassUIDSub
  - gdcm::network::ImplementationClassUIDSub, [589](#)
- ImplementationUIDSub
  - gdcm::network::ImplementationUIDSub, [590](#)
- ImplementationVersionNameSub
  - gdcm::network::ImplementationVersionNameSub, [591](#)
- Implicit
  - gdcm::TransferSyntax, [1134](#)
- ImplicitVRBigEndianACRNEMA
  - gdcm::TransferSyntax, [1135](#)
- ImplicitVRBigEndianPrivateGE
  - gdcm::TransferSyntax, [1135](#)
- ImplicitVRLittleEndian
  - gdcm::TransferSyntax, [1135](#)
- ImplicitVRLittleEndianDefaultTransferSyntaxforDICOM
  - gdcm::UIDs, [1166](#)
- IncompleteLUT
  - gdcm::LookupTable, [666](#)
- InitFromRQ
  - gdcm::network::AAssociateACPDU, [92](#)
- Initialize
  - gdcm::network::ULConnectionInfo, [1239](#)
- InitializeBlueLUT
  - gdcm::LookupTable, [663](#)
- InitializeConnection
  - gdcm::network::ULConnection, [1233](#)
  - gdcm::ServiceClassUser, [985](#)
- Initialized
  - gdcm::LookupTable, [663](#)
- InitializeDataSet
  - gdcm::BaseRootQuery, [186](#)
  - gdcm::FindPatientRootQuery, [502](#)
  - gdcm::FindStudyRootQuery, [505](#)
  - gdcm::MovePatientRootQuery, [716](#)
  - gdcm::MoveStudyRootQuery, [719](#)
  - gdcm::WLMFindQuery, [1417](#)
- InitializeGreenLUT
  - gdcm::LookupTable, [663](#)
- InitializeIncomingConnection
  - gdcm::network::ULConnection, [1233](#)
- InitializeLUT
  - gdcm::LookupTable, [664](#)
- InitializeRedLUT
  - gdcm::LookupTable, [664](#)
- InitializeRTStructSet
  - vtkGDCMPolyDataWriter, [1347](#)
- InitOpenSSL
  - gdcm::OpenSSLCryptoFactory, [754](#)
- Input
  - gdcm::BitmapToBitmapFilter, [212](#)
- Insert
  - gdcm::CommandDataSet, [261](#)
  - gdcm::DataSet, [334](#)
  - gdcm::FileMetaInformation, [476](#)
  - gdcm::GroupDict, [516](#)
- InsertDataElement
  - gdcm::DataSet, [335](#)
  - gdcm::Item, [613](#)
- InsertEntry
  - gdcm::Table, [1098](#)
- InstallPipeline
  - vtkImageColorViewer, [1372](#)
- InstanceAvailabilityNotificationSOPClass
  - gdcm::UIDs, [1171](#)
- INT12
  - gdcm::PixelFormat, [812](#)
- INT16
  - gdcm::PixelFormat, [812](#)
- INT32
  - gdcm::PixelFormat, [812](#)
- INT64
  - gdcm::PixelFormat, [812](#)
- INT8
  - gdcm::PixelFormat, [812](#)
- IntegratedTaxonomicInformationSystemITISTaxonomicSerialNumberTSN
  - gdcm::UIDs, [1172](#)
- Interactor



- vtkImageColorViewer, [1380](#)
- InteractorStyle
  - vtkImageColorViewer, [1380](#)
- INTERFILE
  - gdcm::CSAHeader, [288](#)
- Internal
  - gdcm::ApplicationEntity, [123](#)
  - gdcm::Attribute< Group, Element, TVR, TVM >, [143](#)
  - gdcm::Attribute< Group, Element, TVR, VM::VM1 >, [150](#)
  - gdcm::Element< TVR, TVM >, [400](#)
  - gdcm::Element< VR::AS, VM::VM5 >, [418](#)
  - gdcm::LookupTable, [666](#)
  - gdcm::UI, [1146](#)
- InternalCode
  - gdcm::Coder, [251](#)
  - gdcm::JPEG12Codec, [618](#)
  - gdcm::JPEG16Codec, [621](#)
  - gdcm::JPEG8Codec, [632](#)
- Internals
  - vtkRTStructSetProperties, [1413](#)
- IntraocularLensCalculationsStorage
  - gdcm::UIDs, [1173](#)
- IntravascularOpticalCoherenceTomographyImageStorageForPresentation
  - gdcm::UIDs, [1173](#)
- IntravascularOpticalCoherenceTomographyImageStorageForProcessing
  - gdcm::UIDs, [1173](#)
- INVALID
  - gdcm::VR, [1288](#)
- Invalid
  - gdcm::Overlay, [769](#)
  - gdcm::Usage, [1261](#)
- InverseRescale
  - gdcm::Rescaler, [916](#)
- InverseRescaleFunctionIntoBestFit
  - gdcm::Rescaler, [917](#)
- InvokeEvent
  - gdcm::Subject, [1058](#)
- IOD
  - gdcm::IOD, [598](#)
- IODEntry
  - gdcm::IODEntry, [600](#)
- IODMapType
  - gdcm::IODs, [603](#)
- IODMapTypeConstIterator
  - gdcm::IODs, [603](#)
- IODName
  - gdcm::IODs, [603](#)
- IODs
  - gdcm::IODs, [604](#)
- IPPSorter
  - gdcm::IPPSorter, [607](#)
- IS
  - gdcm::VR, [1288](#)
- IsAETitleValid
  - gdcm::network::AAssociateRQPDU, [101](#)
- IsASCII
  - gdcm::VR, [1291](#)
- IsASCII2
  - gdcm::VR, [1291](#)
- IsBinary
  - gdcm::VR, [1291](#)
- IsBinary2
  - gdcm::VR, [1292](#)
- IsCompatible
  - gdcm::PixelFormat, [815](#)
- IsDual
  - gdcm::VR, [1292](#)
- IsEmpty
  - gdcm::Bitmap, [201](#)
  - gdcm::ByteValue, [228](#)
  - gdcm::CSAElement, [282](#)
  - gdcm::CSAHeaderDict, [294](#)
  - gdcm::Curve, [306](#)
  - gdcm::DataElement, [316](#)
  - gdcm::DataSet, [335](#)
  - gdcm::Defs, [350](#)
  - gdcm::ElementDict, [362](#)
  - gdcm::Dicts, [379](#)
  - gdcm::Filename, [481](#)
  - gdcm::Macros, [672](#)
  - gdcm::Modules, [714](#)
  - gdcm::Overlay, [773](#)
  - gdcm::Preamble, [843](#)
  - gdcm::PrivateDict, [870](#)
  - gdcm::SegmentHelper::BasicCodedEntry, [190](#)
  - gdcm::SequenceOfItems, [970](#)
- IsEncapsulated
  - gdcm::TransferSyntax, [1137](#)
- IsEncoded
  - gdcm::TransferSyntax, [1137](#)
- IsExplicit
  - gdcm::TransferSyntax, [1137](#)
- IsFrameEncoder
  - gdcm::ImageCodec, [556](#)
  - gdcm::JPEG2000Codec, [627](#)
  - gdcm::JPEGCodec, [639](#)
  - gdcm::JPEGLSCCodec, [646](#)
  - gdcm::RLECodec, [923](#)
- IsGroupLength
  - gdcm::Tag, [1109](#)
- IsGroupXX
  - gdcm::Tag, [1109](#)
- IsIdentical
  - gdcm::Filename, [482](#)
- IsIllegal
  - gdcm::Tag, [1110](#)
- IsImage

- gdcM::MediaStorage, [684](#)
- IsImplicit
  - gdcM::TransferSyntax, [1137](#)
- IsInPixelData
  - gdcM::Overlay, [773](#)
- IsKey
  - gdcM::Scanner, [934](#)
  - gdcM::StrictScanner, [1043](#)
- IsLastFragment
  - gdcM::network::AAAbortPDU, [88](#)
  - gdcM::network::AAAssociateACPDU, [92](#)
  - gdcM::network::AAAssociateRJPDU, [95](#)
  - gdcM::network::AAAssociateRQPDU, [101](#)
  - gdcM::network::AReleaseRPPDU, [125](#)
  - gdcM::network::AReleaseRQPDU, [127](#)
  - gdcM::network::BasePDU, [176](#)
  - gdcM::network::PDataTFPDU, [787](#)
- IsLossless
  - gdcM::PhotometricInterpretation, [809](#)
  - gdcM::TransferSyntax, [1138](#)
- IsLossy
  - gdcM::Bitmap, [202](#)
  - gdcM::ImageCodec, [556](#)
  - gdcM::PhotometricInterpretation, [809](#)
  - gdcM::TransferSyntax, [1138](#)
- IsOdd
  - gdcM::VL, [1279](#)
- IsPresentationContextAccepted
  - gdcM::ServiceClassUser, [985](#)
- IsPrintable
  - gdcM::ByteValue, [228](#)
- IsPrivate
  - gdcM::Tag, [1110](#)
- IsPrivateCreator
  - gdcM::Tag, [1110](#)
- IsPublic
  - gdcM::Tag, [1110](#)
- IsRetired
  - gdcM::PhotometricInterpretation, [809](#)
- IsRGB8
  - gdcM::LookupTable, [664](#)
- IsRowEncoder
  - gdcM::ImageCodec, [557](#)
  - gdcM::JPEG2000Codec, [627](#)
  - gdcM::JPEGCodec, [639](#)
  - gdcM::JPEGLSCCodec, [647](#)
  - gdcM::RLECodec, [923](#)
- IsSameColorSpace
  - gdcM::PhotometricInterpretation, [809](#)
- IsStateSuspension
  - gdcM::JPEG12Codec, [618](#)
  - gdcM::JPEG16Codec, [621](#)
  - gdcM::JPEG8Codec, [632](#)
  - gdcM::JPEGCodec, [639](#)
- IsSwap
  - gdcM::VR, [1292](#)
- IsTransferSyntaxCompatible
  - gdcM::Bitmap, [202](#)
- IsUndefined
  - gdcM::MediaStorage, [684](#)
  - gdcM::VL, [1279](#)
- IsUndefinedLength
  - gdcM::DataElement, [316](#)
  - gdcM::SequenceOfItems, [970](#)
- IsUnique
  - gdcM::DictEntry, [371](#)
- IsValid
  - gdcM::ApplicationEntity, [122](#)
  - gdcM::BoxRegion, [216](#)
  - gdcM::CodeString, [255](#)
  - gdcM::DirectionCosines, [384](#)
  - gdcM::FileMetaInformation, [476](#)
  - gdcM::ImageCodec, [557](#)
  - gdcM::JPEGCodec, [639](#)
  - gdcM::LO, [657](#)
  - gdcM::PixelFormat, [816](#)
  - gdcM::Preamble, [843](#)
  - gdcM::Region, [913](#)
  - gdcM::String< TDelimiter, TMaxLength, TPadChar >, [1049](#)
  - gdcM::TagPath, [1118](#)
  - gdcM::TransferSyntax, [1138](#)
  - gdcM::UIDGenerator, [1148](#)
  - gdcM::UUIIDGenerator, [1267](#)
  - gdcM::VM, [1285](#)
  - gdcM::VR, [1292](#)
- IsVRFile
  - gdcM::VR, [1292](#)
- IsZero
  - gdcM::Overlay, [773](#)
- Item
  - gdcM::Item, [612](#)
- Items
  - gdcM::SequenceOfItems, [972](#)
- ItemVector
  - gdcM::SequenceOfItems, [967](#)
- Iterator
  - gdcM::CSAHeaderDict, [293](#)
  - gdcM::DataSet, [330](#)
  - gdcM::Dict, [360](#)
  - gdcM::SequenceOfFragments, [959](#)
  - gdcM::SequenceOfItems, [967](#)
- iterator
  - gdcM::CodeString, [253](#)
  - gdcM::LO, [655](#)
  - gdcM::String< TDelimiter, TMaxLength, TPadChar >, [1047](#)
- ItFileSetHt

- gdcM::SerieHelper, [978](#)
- IVOCTForPresentation
  - gdcM::MediaStorage, [681](#)
- IVOCTForProcessing
  - gdcM::MediaStorage, [681](#)
- Join
  - gdcM::Filename, [482](#)
- JPEG12Codec
  - gdcM::JPEG12Codec, [617](#)
- JPEG16Codec
  - gdcM::JPEG16Codec, [620](#)
- JPEG2000
  - gdcM::TransferSyntax, [1135](#)
- JPEG2000\_COMPRESSION
  - vtkGDCMImageWriter, [1330](#)
- JPEG2000Codec
  - gdcM::JPEG2000Codec, [624](#)
- JPEG2000ImageCompression
  - gdcM::UIDs, [1166](#)
- JPEG2000ImageCompressionLosslessOnly
  - gdcM::UIDs, [1166](#)
- JPEG2000Lossless
  - gdcM::TransferSyntax, [1135](#)
- JPEG2000Part2
  - gdcM::TransferSyntax, [1135](#)
- JPEG2000Part2Lossless
  - gdcM::TransferSyntax, [1135](#)
- JPEG2000Part2MulticomponentImageCompression
  - gdcM::UIDs, [1166](#)
- JPEG2000Part2MulticomponentImageCompressionLosslessOnly
  - gdcM::UIDs, [1166](#)
- JPEG8Codec
  - gdcM::JPEG8Codec, [631](#)
- JPEG\_COMPRESSION
  - vtkGDCMImageWriter, [1330](#)
- JPEGBaselineProcess1
  - gdcM::TransferSyntax, [1135](#)
- JPEGBaselineProcess1DefaultTransferSyntaxforLossyJPEG8BitProgression
  - gdcM::UIDs, [1166](#)
- JPEGCodec
  - gdcM::JPEGCodec, [635](#)
- JPEGExtendedHierarchicalProcess1618Retired
  - gdcM::UIDs, [1166](#)
- JPEGExtendedHierarchicalProcess1719Retired
  - gdcM::UIDs, [1166](#)
- JPEGExtendedProcess24DefaultTransferSyntaxforLossyJPEG8BitProgression
  - gdcM::UIDs, [1166](#)
- JPEGExtendedProcess2\_4
  - gdcM::TransferSyntax, [1135](#)
- JPEGExtendedProcess35Retired
  - gdcM::UIDs, [1166](#)
- JPEGExtendedProcess3\_5
  - gdcM::TransferSyntax, [1135](#)
- JPEGFULLPROGRESSIONHIERARCHICALPROCESS2426RETIRED
  - gdcM::UIDs, [1166](#)
- JPEGFULLPROGRESSIONHIERARCHICALPROCESS2527RETIRED
  - gdcM::UIDs, [1166](#)
- JPEGFULLPROGRESSIONNONHIERARCHICALPROCESS1012RETIRED
  - gdcM::UIDs, [1166](#)
- JPEGFULLPROGRESSIONNONHIERARCHICALPROCESS1113RETIRED
  - gdcM::UIDs, [1166](#)
- JPEGFULLPROGRESSIONPROCESS10\_12
  - gdcM::TransferSyntax, [1135](#)
- JPEGLosslessHierarchicalProcess28Retired
  - gdcM::UIDs, [1166](#)
- JPEGLosslessHierarchicalProcess29Retired
  - gdcM::UIDs, [1166](#)
- JPEGLosslessNonHierarchicalFirstOrderPredictionProcess14SelectionValue
  - gdcM::UIDs, [1166](#)
- JPEGLosslessNonHierarchicalProcess14
  - gdcM::UIDs, [1166](#)
- JPEGLosslessNonHierarchicalProcess15Retired
  - gdcM::UIDs, [1166](#)
- JPEGLosslessProcess14
  - gdcM::TransferSyntax, [1135](#)
- JPEGLosslessProcess14\_1
  - gdcM::TransferSyntax, [1135](#)
- JPEGLS\_COMPRESSION
  - vtkGDCMImageWriter, [1330](#)
- JPEGLSCodec
  - gdcM::JPEGLSCodec, [643](#)
- JPEGLSLossless
  - gdcM::TransferSyntax, [1135](#)
- JPEGLSLosslessImageCompression
  - gdcM::UIDs, [1166](#)
- JPEGLSLossyNearLosslessImageCompression
  - gdcM::UIDs, [1166](#)
- JPEGLSNearLossless
  - gdcM::TransferSyntax, [1135](#)
- JPEGSpectralSelectionHierarchicalProcess2022Retired
  - gdcM::UIDs, [1166](#)
- JPEGSpectralSelectionHierarchicalProcess2123Retired
  - gdcM::UIDs, [1166](#)
- JPEGSpectralSelectionNonHierarchicalProcess68Retired
  - gdcM::UIDs, [1166](#)
- JPEGSpectralSelectionNonHierarchicalProcess79Retired
  - gdcM::UIDs, [1166](#)
- JPEGSpectralSelectionProcess6\_8
  - gdcM::TransferSyntax, [1135](#)
- JPEGSpectralSelectionProcess4only
  - gdcM::TransferSyntax, [1135](#)
- JPEGSpectralSelectionProcess4only
  - gdcM::UIDs, [1166](#)
- JPIPReferencedDeflate
  - gdcM::UIDs, [1166](#)
- JSON
  - gdcM::JSON, [648](#)
- JunkAfterDocElementError

- gdcM::Parser, [782](#)
- KAKADUCodec
  - gdcM::KAKADUCodec, [652](#)
- KeratometryMeasurementsStorage
  - gdcM::UIDs, [1173](#)
- KeyField
  - gdcM::CSAElement, [285](#)
- KeyObjectSelectionDocument
  - gdcM::MediaStorage, [681](#)
- KeyObjectSelectionDocumentStorage
  - gdcM::UIDs, [1170](#)
- KeyValuePairArrayType
  - gdcM::CompositeNetworkFunctions, [265](#)
- KeyValuePairType
  - gdcM::CompositeNetworkFunctions, [265](#)
- KODAK
  - gdcM::EquipmentManufacturer, [433](#)
- LD\_ALL
  - gdcM, [63](#)
- LD\_NOSEQ
  - gdcM, [63](#)
- LD\_NOSHADOW
  - gdcM, [63](#)
- LD\_NOSHADOWSEQ
  - gdcM, [63](#)
- LeadECGWaveformStorage
  - gdcM::MediaStorage, [680](#)
- LegacyConvertedEnhancedCTImageStorage
  - gdcM::MediaStorage, [681](#)
  - gdcM::UIDs, [1172](#)
- LegacyConvertedEnhancedMRIImageStorage
  - gdcM::MediaStorage, [681](#)
  - gdcM::UIDs, [1172](#)
- LegacyConvertedEnhancedPETImageStorage
  - gdcM::MediaStorage, [681](#)
  - gdcM::UIDs, [1172](#)
- LensometryMeasurementsStorage
  - gdcM::UIDs, [1173](#)
- Level
  - vtkImageMapToWindowLevelColors2, [1391](#)
- LINE
  - gdcM::MeshPrimitive, [695](#)
- ListCharSets
  - gdcM::QueryFactory, [887](#)
- LittleEndian
  - gdcM::SwapCode, [1085](#)
- LO
  - gdcM::LO, [657](#)
  - gdcM::VR, [1288](#)
- Load
  - gdcM::Directory, [388](#)
  - gdcM::MrProtocol, [722](#)
- LOADBULKDATA
  - gdcM::XMLPrinter, [1428](#)
- LoadDefault
  - gdcM::CSAHeaderDict, [295](#)
  - gdcM::Dict, [363](#)
  - gdcM::PrivateDict, [870](#)
- LoadDefaults
  - gdcM::Defs, [350](#)
  - gdcM::Dicts, [379](#)
- LoadFromDataElement
  - gdcM::CSAHeader, [291](#)
  - gdcM::PDBHeader, [793](#)
- LoadFromFile
  - gdcM::Defs, [351](#)
- LoadIconImage
  - vtkGDCMImageReader, [1312](#)
  - vtkGDCMImageReader2, [1326](#)
- LoadImageFromFiles
  - gdcM::DirectoryHelper, [392](#)
- LoadOverlays
  - vtkGDCMImageReader, [1312](#)
  - vtkGDCMImageReader2, [1326](#)
- LoadResourcesFiles
  - gdcM::Global, [513](#)
- LoadSingleFile
  - vtkGDCMImageReader, [1302](#)
  - vtkGDCMImageReader2, [1317](#)
- Locate
  - gdcM::Global, [513](#)
- LOComp
  - gdcM, [59](#)
- LodModeType
  - gdcM, [62](#)
- LookupTable
  - gdcM::LookupTable, [660](#)
  - vtkImageMapToColors16, [1387](#)
- LookupTableType
  - gdcM::LookupTable, [660](#)
- LossyFlag
  - gdcM::Bitmap, [208](#)
  - gdcM::ImageCodec, [560](#)
  - vtkGDCMImageReader, [1312](#)
  - vtkGDCMImageReader2, [1326](#)
- LT
  - gdcM::VR, [1288](#)
- LTComp
  - gdcM, [59](#)
- LUT
  - gdcM::Bitmap, [208](#)
  - gdcM::ImageCodec, [560](#)
- LUTPtr
  - gdcM::Bitmap, [197](#)
  - gdcM::ImageCodec, [551](#)
- m\_char

- gdcM::ignore\_char, 525
- m\_ConstMemberFunction
  - gdcM::MemberCommand< T >, 691
- m\_DataSet
  - gdcM::DataSetEvent, 343
- m\_MemberFunction
  - gdcM::MemberCommand< T >, 691
  - gdcM::SimpleMemberCommand< T >, 996
- m\_This
  - gdcM::MemberCommand< T >, 692
  - gdcM::SimpleMemberCommand< T >, 996
- Macro
  - gdcM::Macro, 668
- MacroEntry
  - gdcM, 59
- Macros
  - gdcM::Macros, 671
- mAction
  - gdcM::network::Transition, 1143
- MacularGridThicknessandVolumeReportStorage
  - gdcM::UIDs, 1173
- magenta
  - gdcM::terminal, 85
- MAGNIFIED
  - gdcM::Spacing, 1018
- MakeDirectory
  - gdcM::System, 1093
- MakeNew
  - gdcM::network::Transition, 1142
- MakeObject
  - gdcM::AnonymizeEvent, 109
  - gdcM::DataEvent, 326
  - gdcM::DataSetEvent, 343
  - gdcM::Event, 437
  - gdcM::FileNameEvent, 486
  - gdcM::ProgressEvent, 877
- MammographyCADSR
  - gdcM::MediaStorage, 681
- MammographyCADSRStorage
  - gdcM::UIDs, 1170
- Mandatory
  - gdcM::Usage, 1261
- MANUAL
  - gdcM::Segment, 939
- MapCSAHeaderDictEntry
  - gdcM::CSAHeaderDict, 293
- MapDictEntry
  - gdcM::Dict, 360
- MapIOEntry
  - gdcM::IOD, 597
- MapModuleEntry
  - gdcM::Macro, 668
  - gdcM::Module, 706
- MappingType
  - gdcM::Scanner, 929
  - gdcM::StrictScanner, 1038
- MapScalarsThroughTable2
  - vtkLookupTable16, 1401
- MapTableEntry
  - gdcM::Table, 1097
- MARCONI
  - gdcM::EquipmentManufacturer, 433
- MaxLengthSub
  - gdcM::network::MaxLengthSub, 673
- MaxLength
  - gdcM::ApplicationEntity, 123
  - gdcM::PersonName, 802
- MaxNumberOfComponents
  - gdcM::ApplicationEntity, 123
  - gdcM::PersonName, 802
- MaxPrintLength
  - gdcM::Printer, 868
- MayoClinicNonradiologicalImagesSBSAnatomicalSurfaceRegionGuide
  - gdcM::UIDs, 1172
- mConnection
  - gdcM::network::ULConnectionManager, 1247
- MD5DataImagesType
  - gdcM::Testing, 1120
- MD5MetalImagesType
  - vtkGDCMTesting, 1351
- mDataSet
  - gdcM::BaseQuery, 182
- MediaCreationManagementSOPClassUID
  - gdcM::UIDs, 1168
- MediaStorage
  - gdcM::MediaStorage, 682
- MediaStorageDataFilesType
  - gdcM::Testing, 1120
- MediaStorageDirectoryStorage
  - gdcM::MediaStorage, 679
  - gdcM::UIDs, 1167
- MedicalImageProperties
  - vtkGDCMImageReader, 1312
  - vtkGDCMPolyDataReader, 1345
  - vtkGDCMPolyDataWriter, 1349
- mElementOffsets
  - gdcM::StreamImageWriter, 1034
- mElementOffsets1
  - gdcM::StreamImageWriter, 1034
- MemberCommand
  - gdcM::MemberCommand< T >, 689
- mEnd
  - gdcM::network::Transition, 1143
- MeshPrimitive
  - gdcM::MeshPrimitive, 695
- MessageID
  - gdcM::network::CEchoRQ, 238
- MetaInformationTS

- gdcM::FileMetaInformation, [479](#)
- mHelpDescription
  - gdcM::BaseRootQuery, [187](#)
- mImage
  - gdcM::BaseRootQuery, [187](#)
- mImplicit
  - gdcM::network::ULConnectionCallback, [1238](#)
- ModalityPerformedProcedureStepCreateQuery
  - gdcM::ModalityPerformedProcedureStepCreateQuery, [700](#)
- ModalityPerformedProcedureStepNotificationSOPClass
  - gdcM::UIDs, [1167](#)
- ModalityPerformedProcedureStepRetrieveSOPClass
  - gdcM::UIDs, [1167](#)
- ModalityPerformedProcedureStepSetQuery
  - gdcM::ModalityPerformedProcedureStepSetQuery, [703](#)
- ModalityPerformedProcedureStepSOPClass
  - gdcM::MediaStorage, [681](#)
  - gdcM::UIDs, [1167](#)
- ModalityWorklistInformationModelFIND
  - gdcM::UIDs, [1170](#)
- Mode
  - gdcM::terminal, [86](#)
- Module
  - gdcM::Module, [706](#)
- ModuleEntry
  - gdcM::ModuleEntry, [710](#)
- ModuleMapType
  - gdcM::Macros, [671](#)
  - gdcM::Modules, [713](#)
- Modules
  - gdcM::Modules, [713](#)
- MONOCHROME1
  - gdcM::PhotometricInterpretation, [808](#)
- MONOCHROME2
  - gdcM::PhotometricInterpretation, [808](#)
- MouseGenomeInitiativeMGI
  - gdcM::UIDs, [1172](#)
- MovePatientRootQuery
  - gdcM::MovePatientRootQuery, [716](#)
- MoveStudyRootQuery
  - gdcM::MoveStudyRootQuery, [719](#)
- mPatient
  - gdcM::BaseRootQuery, [187](#)
- MPEG2MainProfile
  - gdcM::TransferSyntax, [1135](#)
- MPEG2MainProfileHighLevel
  - gdcM::TransferSyntax, [1135](#)
  - gdcM::UIDs, [1172](#)
- MPEG2MainProfileMainLevel
  - gdcM::UIDs, [1166](#)
- MPEG4AVCH264BDcompatibleHighProfileLevel4\_1
  - gdcM::TransferSyntax, [1135](#)
- MPEG4AVCH264HighProfileLevel4\_1
  - gdcM::TransferSyntax, [1135](#)
  - gdcM::UIDs, [1172](#)
- MPEG4AVCH\_264BDcompatibleHighProfileLevel4\_1
  - gdcM::UIDs, [1172](#)
- MPEG4AVCH\_264HighProfileLevel4\_1
  - gdcM::UIDs, [1172](#)
- MPEG4AVCH\_264HighProfileLevel4\_2For2DVideo
  - gdcM::UIDs, [1173](#)
- MPEG4AVCH\_264HighProfileLevel4\_2For3DVideo
  - gdcM::UIDs, [1173](#)
- MPEG4AVCH\_264StereoHighProfileLevel4\_2
  - gdcM::UIDs, [1173](#)
- MPTType
  - gdcM::MeshPrimitive, [694](#)
- MPTType\_END
  - gdcM::MeshPrimitive, [695](#)
- MRImageStorage
  - gdcM::MediaStorage, [679](#)
  - gdcM::UIDs, [1168](#)
- mRootType
  - gdcM::BaseRootQuery, [187](#)
- MrProtocol
  - gdcM::MrProtocol, [721](#)
- MRSpectroscopyStorage
  - gdcM::MediaStorage, [680](#)
  - gdcM::UIDs, [1168](#)
- MS\_END
  - gdcM::MediaStorage, [681](#)
- mSecondaryConnection
  - gdcM::network::ULConnectionManager, [1247](#)
- mSeries
  - gdcM::BaseRootQuery, [187](#)
- mSopInstanceUID
  - gdcM::BaseQuery, [182](#)
- mSPFile
  - gdcM::StreamImageWriter, [1034](#)
- mStudy
  - gdcM::BaseRootQuery, [187](#)
- MSType
  - gdcM::MediaStorage, [679](#)
- mTransitions
  - gdcM::network::ULConnectionManager, [1247](#)
- MultiframeGrayscaleByteSecondaryCaptureImageStorage
  - gdcM::MediaStorage, [680](#)
  - gdcM::UIDs, [1169](#)
- MultiframeGrayscaleWordSecondaryCaptureImageStorage
  - gdcM::MediaStorage, [680](#)
  - gdcM::UIDs, [1169](#)
- MultiframeSingleBitSecondaryCaptureImageStorage
  - gdcM::MediaStorage, [680](#)
  - gdcM::UIDs, [1169](#)
- MultiframeTrueColorSecondaryCaptureImageStorage
  - gdcM::MediaStorage, [680](#)
  - gdcM::UIDs, [1169](#)

- MultipleVolumeRenderingVolumetricPresentationStateStorage
  - gdcm::UIDs, [1173](#)
- mWriter
  - gdcm::StreamImageWriter, [1034](#)
- mXMax
  - gdcm::StreamImageWriter, [1034](#)
- mXMin
  - gdcm::StreamImageWriter, [1035](#)
- mYMax
  - gdcm::StreamImageWriter, [1035](#)
- mYMin
  - gdcm::StreamImageWriter, [1035](#)
- mZMax
  - gdcm::StreamImageWriter, [1035](#)
- mZMin
  - gdcm::StreamImageWriter, [1035](#)
- N\_ACTION\_RQ
  - gdcm::network::DIMSE, [381](#)
- N\_ACTION\_RSP
  - gdcm::network::DIMSE, [381](#)
- N\_CREATE\_RQ
  - gdcm::network::DIMSE, [381](#)
- N\_CREATE\_RSP
  - gdcm::network::DIMSE, [381](#)
- N\_DELETE\_RQ
  - gdcm::network::DIMSE, [381](#)
- N\_DELETE\_RSP
  - gdcm::network::DIMSE, [381](#)
- N\_EVENT\_REPORT\_RQ
  - gdcm::network::DIMSE, [381](#)
- N\_EVENT\_REPORT\_RSP
  - gdcm::network::DIMSE, [381](#)
- N\_GET\_RQ
  - gdcm::network::DIMSE, [381](#)
- N\_GET\_RSP
  - gdcm::network::DIMSE, [381](#)
- N\_SET\_RQ
  - gdcm::network::DIMSE, [381](#)
- N\_SET\_RSP
  - gdcm::network::DIMSE, [381](#)
- NAction
  - gdcm::NormalizedNetworkFunctions, [744](#)
- Name
  - gdcm::ModuleEntry, [712](#)
- NameField
  - gdcm::CSAElement, [285](#)
  - gdcm::PDSElement, [791](#)
- NativeDICOMModel
  - gdcm::UIDs, [1175](#)
- NCreate
  - gdcm::NormalizedNetworkFunctions, [745](#)
- NDelete
  - gdcm::NormalizedNetworkFunctions, [745](#)
- NeedByteSwap
  - gdcm::Bitmap, [208](#)
  - gdcm::ImageCodec, [560](#)
- NeedOverlayCleanup
  - gdcm::ImageCodec, [561](#)
- NegotiatedType
  - gdcm::TransferSyntax, [1134](#)
- NestedMacroEntries
  - gdcm, [59](#)
- NestedModuleEntries
  - gdcm::NestedModuleEntries, [733](#)
- NEventReport
  - gdcm::NormalizedNetworkFunctions, [745](#)
- New
  - gdcm::Anonymizer, [115](#)
  - gdcm::FileChangeTransferSyntax, [458](#)
  - gdcm::FileStreamer, [496](#)
  - gdcm::MemberCommand< T >, [690](#)
  - gdcm::Scanner, [934](#)
  - gdcm::SequenceOfFragments, [962](#)
  - gdcm::SequenceOfItems, [970](#)
  - gdcm::ServiceClassUser, [985](#)
  - gdcm::SimpleMemberCommand< T >, [995](#)
  - gdcm::StrictScanner, [1043](#)
  - vtkGDCMImageReader, [1303](#)
  - vtkGDCMImageReader2, [1317](#)
  - vtkGDCMImageWriter, [1331](#)
  - vtkGDCMMedicalImageProperties, [1339](#)
  - vtkGDCMPolyDataReader, [1342](#)
  - vtkGDCMPolyDataWriter, [1347](#)
  - vtkGDCMTesting, [1353](#)
  - vtkGDCMThreadedImageReader, [1356](#)
  - vtkGDCMThreadedImageReader2, [1360](#)
  - vtkImageColorViewer, [1372](#)
  - vtkImageMapToColors16, [1384](#)
  - vtkImageMapToWindowLevelColors2, [1390](#)
  - vtkImagePlanarComponentsToComponents, [1393](#)
  - vtkImageRGBToYBR, [1396](#)
  - vtkImageYBRToRGB, [1398](#)
  - vtkLookupTable16, [1401](#)
  - vtkRTStructSetProperties, [1409](#)
- NewYorkUniversityMelanomaClinicalCooperativeGroup
  - gdcm::UIDs, [1172](#)
- NGet
  - gdcm::NormalizedNetworkFunctions, [745](#)
- NO
  - gdcm::Surface, [1062](#)
- NO\_COMPRESSION
  - vtkGDCMImageWriter, [1330](#)
- NoElementsError
  - gdcm::Parser, [782](#)
- NoError
  - gdcm::Parser, [782](#)
- NOMAGIC



- gdcM::CSAHeader, [288](#)
- NoMemoryError
  - gdcM::Parser, [782](#)
- NoObject
  - gdcM::MediaStorage, [682](#)
- NoOfItemsField
  - gdcM::CSAElement, [285](#)
- Normal
  - gdcM::MrProtocol::Slice, [1001](#)
- Normalize
  - gdcM::DirectionCosines, [384](#)
- NSet
  - gdcM::NormalizedNetworkFunctions, [746](#)
- NuclearMedicineImageStorage
  - gdcM::MediaStorage, [680](#)
  - gdcM::UIDs, [1169](#)
- NuclearMedicineImageStorageRetired
  - gdcM::MediaStorage, [680](#)
  - gdcM::UIDs, [1169](#)
- Null0
  - gdcM::UIDs, [1173](#)
- Null1
  - gdcM::UIDs, [1173](#)
- NumberOfDimensions
  - gdcM::Bitmap, [208](#)
  - gdcM::ImageCodec, [561](#)
- NumberOfIconImages
  - vtkGDCMImageReader, [1312](#)
  - vtkGDCMImageReader2, [1327](#)
- NumberOfOverlays
  - vtkGDCMImageReader, [1312](#)
  - vtkGDCMImageReader2, [1327](#)
- NumberOfSurfaces
  - gdcM::SurfaceWriter, [1083](#)
- OB
  - gdcM::VR, [1288](#)
- OB\_OW
  - gdcM::VR, [1289](#)
- Object
  - gdcM::Object, [751](#)
- ObjectEnd
  - gdcM::MediaStorage, [682](#)
- ObjectType
  - gdcM::MediaStorage, [682](#)
- OBLIQUE
  - gdcM::Orientation, [764](#)
- OD
  - gdcM::VR, [1288](#)
- OF
  - gdcM::VR, [1288](#)
- Ofstream
  - gdcM::Writer, [1424](#)
- OL
  - gdcM::VR, [1288](#)
- OnlyUUID
  - gdcM::XMLPrinter, [1428](#)
- op
  - gdcM::SerieHelper, [979](#)
- OPENSSL
  - gdcM::CryptoFactory, [273](#)
- OpenSSLCryptoFactory
  - gdcM::OpenSSLCryptoFactory, [754](#)
- OpenSSLCryptographicMessageSyntax
  - gdcM::OpenSSLCryptographicMessageSyntax, [756](#)
- OPENSSL7
  - gdcM::CryptoFactory, [273](#)
- OpenSSL7CryptoFactory
  - gdcM::OpenSSL7CryptoFactory, [759](#)
- OpenSSL7CryptographicMessageSyntax
  - gdcM::OpenSSL7CryptographicMessageSyntax, [761](#)
- operator const char \*
  - gdcM::ConstCharWrapper, [269](#)
  - gdcM::Filename, [482](#)
  - gdcM::String< TDelimiter, TMaxLength, TPadChar >, [1049](#)
- operator const double \*
  - gdcM::DirectionCosines, [385](#)
- operator const std::vector< char > &
  - gdcM::ByteValue, [228](#)
- operator MStype
  - gdcM::MediaStorage, [685](#)
- operator ObjectType \*
  - gdcM::SmartPointer< ObjectType >, [1006](#)
- operator PType
  - gdcM::PhotometricInterpretation, [810](#)
- operator ScalarType
  - gdcM::PixelFormat, [816](#)
- operator SwapCode::SwapCodeType
  - gdcM::SwapCode, [1086](#)
- operator TStype
  - gdcM::TransferSyntax, [1138](#)
  - gdcM::UIDs, [1186](#)
- operator TypeType
  - gdcM::Type, [1145](#)
- operator uint32\_t
  - gdcM::VL, [1279](#)
- operator UsageType
  - gdcM::Usage, [1262](#)
- operator VMType
  - gdcM::VM, [1285](#)
- operator VRType
  - gdcM::VR, [1293](#)
- operator!=
  - gdcM, [64](#)
  - gdcM::Attribute< Group, Element, TVR, TVM >, [140](#)



- gdcM::Attribute< Group, Element, TVR, VM::VM1 >, 148
- gdcM::CodeString, 256
- gdcM::PixelFormat, 816
- gdcM::Tag, 1111
- operator<
  - gdcM::Attribute< Group, Element, TVR, TVM >, 140
  - gdcM::Attribute< Group, Element, TVR, VM::VM1 >, 148
  - gdcM::CSAElement, 283
  - gdcM::CSAHeaderDictEntry, 297
  - gdcM::DataElement, 317
  - gdcM::PrivateTag, 873
  - gdcM::Tag, 1111
- operator<<
  - gdcM, 64–74
  - gdcM::BasicOffsetTable, 193
  - gdcM::CodeString, 256
  - gdcM::CommandDataSet, 262
  - gdcM::CSAElement, 285
  - gdcM::CSAHeader, 292
  - gdcM::CSAHeaderDict, 295
  - gdcM::CSAHeaderDictEntry, 298
  - gdcM::DataElement, 321
  - gdcM::DataSet, 339
  - gdcM::Dict, 363
  - gdcM::DictEntry, 372
  - gdcM::Dicts, 380
  - gdcM::Directory, 389
  - gdcM::File, 452
  - gdcM::FileMetaInformation, 478
  - gdcM::FileSet, 493
  - gdcM::Fragment, 510
  - gdcM::Global, 514
  - gdcM::GroupDict, 517
  - gdcM::IOD, 599
  - gdcM::IODEntry, 602
  - gdcM::IODs, 605
  - gdcM::Item, 614
  - gdcM::Macro, 670
  - gdcM::Macros, 672
  - gdcM::MediaStorage, 686
  - gdcM::Module, 707
  - gdcM::ModuleEntry, 711
  - gdcM::Modules, 714
  - gdcM::MrProtocol, 723
  - gdcM::NestedModuleEntries, 734
  - gdcM::Object, 752
  - gdcM::Orientation, 766
  - gdcM::PDBElement, 790
  - gdcM::PDBHeader, 794
  - gdcM::PhotometricInterpretation, 810
  - gdcM::PixelFormat, 818
  - gdcM::Preamble, 844
  - gdcM::PrivateDict, 871
  - gdcM::PrivateTag, 874
  - gdcM::Scanner, 935
  - gdcM::Sorter, 1015
  - gdcM::StrictScanner, 1044
  - gdcM::SwapCode, 1086
  - gdcM::Table, 1098
  - gdcM::Tag, 1115
  - gdcM::TransferSyntax, 1138
  - gdcM::Type, 1145
  - gdcM::UI, 1146
  - gdcM::Usage, 1262
  - gdcM::Version, 1276
  - gdcM::VL, 1281
  - gdcM::VM, 1285
  - gdcM::VR, 1293
- operator<=
  - gdcM::Tag, 1111
- operator>>
  - gdcM, 74, 75
  - gdcM::Tag, 1115
- operator\*
  - gdcM::SmartPointer< ObjectType >, 1006
- operator()
  - gdcM::DataSet, 335
  - gdcM::Scanner::Itstr, 666
  - gdcM::StrictScanner::Itstr, 667
- operator++
  - gdcM::VL, 1279
- operator+=
  - gdcM::VL, 1279
- operator->
  - gdcM::SmartPointer< ObjectType >, 1006
- operator=
  - gdcM::AnonymizeEvent, 110
  - gdcM::ASN1, 132
  - gdcM::Base64, 170
  - gdcM::BoxRegion, 216
  - gdcM::ByteSwapFilter, 222
  - gdcM::ByteValue, 228
  - gdcM::Command, 259
  - gdcM::CryptographicMessageSyntax, 277
  - gdcM::CSAElement, 283
  - gdcM::CSAHeaderDict, 295
  - gdcM::DataElement, 317
  - gdcM::DataEvent, 327
  - gdcM::DataSet, 335
  - gdcM::DataSetEvent, 343
  - gdcM::Defs, 351
  - gdcM::Dict, 363
  - gdcM::Dicts, 379
  - gdcM::Element< TVR, VM::VM1\_n >, 406
  - gdcM::Event, 437
  - gdcM::FileMetaInformation, 476

- gdcM::FileNameEvent, 486
- gdcM::Global, 514
- gdcM::MemberCommand< T >, 690
- gdcM::network::ULAction, 1189
- gdcM::network::ULConnection, 1234
- gdcM::network::UserInformation, 1265
- gdcM::Object, 752
- gdcM::Overlay, 773
- gdcM::ParseException, 778
- gdcM::Preamble, 843
- gdcM::ProgressEvent, 877
- gdcM::SequenceOfItems, 971
- gdcM::ServiceClassUser, 986
- gdcM::SHA1, 991
- gdcM::SimpleMemberCommand< T >, 996
- gdcM::SimpleSubjectWatcher, 998
- gdcM::SmartPointer< ObjectType >, 1006, 1007
- gdcM::Table, 1098
- gdcM::Tag, 1111
- operator==
  - gdcM, 74
  - gdcM::Attribute< Group, Element, TVR, TVM >, 140
  - gdcM::Attribute< Group, Element, TVR, VM::VM1 >, 148
  - gdcM::ByteValue, 228, 229
  - gdcM::CodeString, 256
  - gdcM::CSAElement, 283
  - gdcM::DataElement, 317
  - gdcM::network::AbstractSyntax, 105
  - gdcM::network::PresentationContextRQ, 858
  - gdcM::network::TransferSyntaxSub, 1140
  - gdcM::PDBElement, 790
  - gdcM::PixelFormat, 816
  - gdcM::PresentationContext, 847
  - gdcM::SequenceOfFragments, 962
  - gdcM::SequenceOfItems, 971
  - gdcM::Tag, 1111
  - gdcM::Value, 1272
- operator[]
  - gdcM::Attribute< Group, Element, TVR, TVM >, 140
  - gdcM::Attribute< Group, Element, TVR, VM::VM1\_n >, 157
  - gdcM::DataSet, 336
  - gdcM::Element< TVR, TVM >, 399
  - gdcM::Element< TVR, VM::VM1\_n >, 406
  - gdcM::Tag, 1112
- OphthalmicAxialMeasurementsStorage
  - gdcM::UIDs, 1173
- OphthalmicOpticalCoherenceTomographyBscanVolumeAnalysisStorage
  - gdcM::UIDs, 1173
- OphthalmicOpticalCoherenceTomographyEnFacelImageStorage
  - gdcM::UIDs, 1173
- OphthalmicPhotography16BitImageStorage
  - gdcM::MediaStorage, 681
  - gdcM::UIDs, 1170
- OphthalmicPhotography8BitImageStorage
  - gdcM::MediaStorage, 681
  - gdcM::UIDs, 1170
- OphthalmicThicknessMapStorage
  - gdcM::UIDs, 1173
- OphthalmicTomographyImageStorage
  - gdcM::MediaStorage, 681
  - gdcM::UIDs, 1170
- OphthalmicVisualFieldStaticPerimetryMeasurementsStorage
  - gdcM::UIDs, 1173
- OrderFileList
  - gdcM::SerieHelper, 977
- Orientation
  - gdcM::Orientation, 764
- OrientationType
  - gdcM::Orientation, 764
- Output
  - gdcM::BitmapToBitmapFilter, 212
- OutputFormat
  - vtkImageMapToColors16, 1387
- OutputTypes
  - gdcM::DictConverter, 365
- OV
  - gdcM::VR, 1288
- Overlay
  - gdcM::Overlay, 770
- OverlayImageActor
  - vtkImageColorViewer, 1380
- Overlays
  - gdcM::Pixmap, 824
- OverlayType
  - gdcM::Overlay, 769
- OW
  - gdcM::VR, 1288
- Pack
  - gdcM::Unpacker12Bits, 1259
- Padding
  - gdcM::ApplicationEntity, 123
  - gdcM::PersonName, 803
- PALETTE\_COLOR
  - gdcM::PhotometricInterpretation, 808
- Papyrus3ImplicitVRLittleEndian
  - gdcM::UIDs, 1172
- ParametricMapStorage
  - gdcM::UIDs, 1173
- Parent
  - gdcM::Element< TVR, VM::VM1\_2 >, 402
  - gdcM::Element< TVR, VM::VM2\_2n >, 409
  - gdcM::Element< TVR, VM::VM2\_n >, 411
  - gdcM::Element< TVR, VM::VM3\_3n >, 413
  - gdcM::Element< TVR, VM::VM3\_4 >, 415
  - gdcM::Element< TVR, VM::VM3\_n >, 417

- Parse
  - gdcm::Parser, [783](#)
- ParseBuffer
  - gdcm::Parser, [783](#)
- ParseCertificateFile
  - gdcm::CAPICryptographicMessageSyntax, [236](#)
  - gdcm::CryptographicMessageSyntax, [277](#)
  - gdcm::OpenSSLCryptographicMessageSyntax, [757](#)
  - gdcm::OpenSSL7CryptographicMessageSyntax, [762](#)
- ParseDateTime
  - gdcm::System, [1093](#), [1094](#)
- ParseDump
  - gdcm::ASN1, [132](#)
- ParseDumpFile
  - gdcm::ASN1, [132](#)
- ParseException
  - gdcm::ParseException, [778](#)
- ParseKeyFile
  - gdcm::CAPICryptographicMessageSyntax, [236](#)
  - gdcm::CryptographicMessageSyntax, [277](#)
  - gdcm::OpenSSLCryptographicMessageSyntax, [757](#)
  - gdcm::OpenSSL7CryptographicMessageSyntax, [762](#)
- Parser
  - gdcm::Parser, [782](#)
- PassAlphaToOutput
  - vtkImageMapToColors16, [1388](#)
- Patient
  - gdcm::Patient, [784](#)
- PatientRadiationDoseSRStorage
  - gdcm::UIDs, [1174](#)
- PatientRootQueryRetrieveInformationModelFIND
  - gdcm::UIDs, [1170](#)
- PatientRootQueryRetrieveInformationModelGET
  - gdcm::UIDs, [1170](#)
- PatientRootQueryRetrieveInformationModelMOVE
  - gdcm::UIDs, [1170](#)
- PatientStudyOnlyQueryRetrieveInformationModelFINDRetired
  - gdcm::UIDs, [1170](#)
- PatientStudyOnlyQueryRetrieveInformationModelGETRetired
  - gdcm::UIDs, [1170](#)
- PatientStudyOnlyQueryRetrieveInformationModelMOVERetired
  - gdcm::UIDs, [1170](#)
- PDataTFPDU
  - gdcm::network::PDataTFPDU, [786](#)
- PDBElement
  - gdcm::PDBElement, [789](#)
- PDBHeader
  - gdcm::PDBHeader, [792](#)
- PDF
  - gdcm::MediaStorage, [682](#)
- PDFCodec
  - gdcm::PDFCodec, [796](#)
- PerformAction
  - gdcm::network::ULAction, [1189](#)
  - gdcm::network::ULActionAA1, [1190](#)
  - gdcm::network::ULActionAA2, [1192](#)
  - gdcm::network::ULActionAA3, [1193](#)
  - gdcm::network::ULActionAA4, [1194](#)
  - gdcm::network::ULActionAA5, [1196](#)
  - gdcm::network::ULActionAA6, [1197](#)
  - gdcm::network::ULActionAA7, [1198](#)
  - gdcm::network::ULActionAA8, [1200](#)
  - gdcm::network::ULActionAE1, [1201](#)
  - gdcm::network::ULActionAE2, [1202](#)
  - gdcm::network::ULActionAE3, [1204](#)
  - gdcm::network::ULActionAE4, [1205](#)
  - gdcm::network::ULActionAE5, [1206](#)
  - gdcm::network::ULActionAE6, [1208](#)
  - gdcm::network::ULActionAE7, [1209](#)
  - gdcm::network::ULActionAE8, [1210](#)
  - gdcm::network::ULActionAR1, [1212](#)
  - gdcm::network::ULActionAR10, [1213](#)
  - gdcm::network::ULActionAR2, [1214](#)
  - gdcm::network::ULActionAR3, [1216](#)
  - gdcm::network::ULActionAR4, [1217](#)
  - gdcm::network::ULActionAR5, [1218](#)
  - gdcm::network::ULActionAR6, [1220](#)
  - gdcm::network::ULActionAR7, [1221](#)
  - gdcm::network::ULActionAR8, [1222](#)
  - gdcm::network::ULActionAR9, [1224](#)
  - gdcm::network::ULActionDT1, [1225](#)
  - gdcm::network::ULActionDT2, [1226](#)
- PerformedImagingAgentAdministrationSRStorage
  - gdcm::UIDs, [1174](#)
- PET20StepColorPaletteSOPInstance
  - gdcm::UIDs, [1172](#)
- PETColorPaletteSOPInstance
  - gdcm::UIDs, [1172](#)
- PETImageStorage
  - gdcm::MediaStorage, [680](#)
- gdcm::Bitmap, [208](#)
- gdcm::ImageCodec, [561](#)
- PGXCodec
  - gdcm::PGXCodec, [804](#)
- PHILIPS
  - gdcm::Dicts, [377](#)
- Philips3D
  - gdcm::MediaStorage, [680](#)
- PhilipsPrivateMRSyntheticImageStorage
  - gdcm::MediaStorage, [681](#)
- PhotometricInterpretation
  - gdcm::PhotometricInterpretation, [808](#)
- PI
  - gdcm::Bitmap, [208](#)
  - gdcm::ImageCodec, [561](#)

- PI\_END
  - gdcm::PhotometricInterpretation, [808](#)
- PIType
  - gdcm::PhotometricInterpretation, [807](#)
- PixelData
  - gdcm::Bitmap, [209](#)
  - gdcm::PixmapReader, [829](#)
  - gdcm::PixmapWriter, [836](#)
- PixelFormat
  - gdcm::PixelFormat, [813](#)
- Pixmap
  - gdcm::Pixmap, [821](#)
- PixmapReader
  - gdcm::Bitmap, [207](#)
  - gdcm::PixmapReader, [827](#)
- PixmapToPixmapFilter
  - gdcm::PixmapToPixmapFilter, [831](#)
- PixmapWriter
  - gdcm::PixmapWriter, [834](#)
- PlanarConfiguration
  - gdcm::Bitmap, [209](#)
  - gdcm::ImageCodec, [561](#)
  - vtkGDCMImageReader, [1312](#)
  - vtkGDCMImageReader2, [1327](#)
- PlannedImagingAgentAdministrationSRStorage
  - gdcm::UIDs, [1174](#)
- PMS
  - gdcm::EquipmentManufacturer, [433](#)
- PN
  - gdcm::VR, [1288](#)
- PNComp
  - gdcm, [59](#)
- PNMCodec
  - gdcm::PNMCodec, [838](#)
- pointer
  - gdcm::CodeString, [254](#)
  - gdcm::LO, [656](#)
  - gdcm::String< TDelimiter, TMaxLength, TPadChar >, [1047](#)
- POINTS
  - gdcm::Surface, [1062](#)
- Position
  - gdcm::MrProtocol::Slice, [1001](#)
- PositronEmissionTomographyImageStorage
  - gdcm::UIDs, [1170](#)
- Preamble
  - gdcm::Preamble, [841](#), [842](#)
- PrepareWrite
  - gdcm::PixmapWriter, [835](#)
  - gdcm::SegmentWriter, [955](#)
  - gdcm::SurfaceWriter, [1083](#)
- PrepareWritePointMacro
  - gdcm::SurfaceWriter, [1083](#)
- Prepend
  - gdcm::Global, [514](#)
- PresentationContext
  - gdcm::PresentationContext, [846](#)
- PresentationContextAC
  - gdcm::network::PresentationContextAC, [849](#)
- PresentationContextArrayType
  - gdcm::network::AAssociateRQPDU, [98](#)
  - gdcm::PresentationContextGenerator, [853](#)
- PresentationContextGenerator
  - gdcm::PresentationContextGenerator, [853](#)
- PresentationContextRQ
  - gdcm::network::PresentationContextRQ, [856](#)
- PresentationDataValue
  - gdcm::network::PresentationDataValue, [860](#)
- PresentationLUTSOPClass
  - gdcm::UIDs, [1168](#)
- PrettyPrintOff
  - gdcm::JSON, [649](#)
- PrettyPrintOn
  - gdcm::JSON, [650](#)
- PrimitiveData
  - gdcm::MeshPrimitive, [697](#)
- PrimitivesData
  - gdcm::MeshPrimitive, [694](#)
- PrimitiveType
  - gdcm::MeshPrimitive, [698](#)
- Print
  - gdcm::ApplicationEntity, [122](#)
  - gdcm::Attribute< Group, Element, TVR, TVM >, [141](#)
  - gdcm::Attribute< Group, Element, TVR, VM::VM1 >, [149](#)
  - gdcm::Attribute< Group, Element, TVR, VM::VM1\_n >, [157](#)
  - gdcm::BaseQuery, [180](#)
  - gdcm::Bitmap, [202](#)
  - gdcm::BoxRegion, [217](#)
  - gdcm::ByteValue, [229](#)
  - gdcm::CSAHeader, [291](#)
  - gdcm::Curve, [307](#)
  - gdcm::DataSet, [336](#)
  - gdcm::DictPrinter, [375](#)
  - gdcm::DirectionCosines, [385](#)
  - gdcm::Directory, [389](#)
  - gdcm::Element< TVR, TVM >, [399](#)
  - gdcm::Element< TVR, VM::VM1\_n >, [406](#)
  - gdcm::Element< VR::AS, VM::VM5 >, [418](#)
  - gdcm::Event, [437](#)
  - gdcm::Image, [529](#)
  - gdcm::LookupTable, [664](#)
  - gdcm::MrProtocol, [722](#)
  - gdcm::network::AAAbortPDU, [88](#)
  - gdcm::network::AAssociateACPDU, [93](#)
  - gdcm::network::AAssociateRJPDU, [96](#)
  - gdcm::network::AAssociateRQPDU, [101](#)

- gdcM::network::AbstractSyntax, 105
- gdcM::network::ApplicationContext, 120
- gdcM::network::AReleaseRPPDU, 125
- gdcM::network::AReleaseRQPDU, 128
- gdcM::network::AsynchronousOperationsWindowSub, 133
- gdcM::network::BasePDU, 176
- gdcM::network::ImplementationClassUIDSub, 589
- gdcM::network::ImplementationVersionNameSub, 592
- gdcM::network::MaximumLengthSub, 673
- gdcM::network::PDataTFPDU, 787
- gdcM::network::PresentationContextAC, 850
- gdcM::network::PresentationContextRQ, 858
- gdcM::network::PresentationDataValue, 861
- gdcM::network::RoleSelectionSub, 925
- gdcM::network::ServiceClassApplicationInformation, 981
- gdcM::network::SOPClassExtendedNegotiationSub, 1008
- gdcM::network::TransferSyntaxSub, 1140
- gdcM::network::UserInformation, 1265
- gdcM::Object, 752
- gdcM::Orientation, 765
- gdcM::Overlay, 774
- gdcM::PDBHeader, 794
- gdcM::PersonName, 801
- gdcM::PixelFormat, 817
- gdcM::Pixmap, 823
- gdcM::Preamble, 843
- gdcM::PresentationContext, 848
- gdcM::Printer, 866
- gdcM::Region, 913
- gdcM::Scanner, 934
- gdcM::SegmentedPaletteColorLookupTable, 948
- gdcM::SequenceOfFragments, 962
- gdcM::SequenceOfItems, 971
- gdcM::Sorter, 1014
- gdcM::StrictScanner, 1043
- gdcM::TagPath, 1118
- gdcM::Testing, 1126
- gdcM::Version, 1276
- gdcM::XMLPrinter, 1429
- PrintASCII
  - gdcM::ByteValue, 229
- PrintASCIIXML
  - gdcM::ByteValue, 229
- PrintAsContinuousString
  - gdcM::Tag, 1112
- PrintAsContinuousUpperCaseString
  - gdcM::Tag, 1112
- PrintAsPipeSeparatedString
  - gdcM::Tag, 1112
- PrintDataElement
  - gdcM::Printer, 866
  - gdcM::XMLPrinter, 1429
- PrintDataElement2
  - gdcM::DictPrinter, 375
- PrintDataSet
  - gdcM::Printer, 866
  - gdcM::XMLPrinter, 1430
- PrintDataSet2
  - gdcM::DictPrinter, 375
- Printer
  - gdcM::Printer, 865
- PrinterConfigurationRetrievalSOPClass
  - gdcM::UIDs, 1168
- PrinterConfigurationRetrievalSOPInstance
  - gdcM::UIDs, 1168
- PrinterSOPClass
  - gdcM::UIDs, 1168
- PrinterSOPInstance
  - gdcM::UIDs, 1168
- PrintGroupLength
  - gdcM::ByteValue, 229
- PrintHex
  - gdcM::ByteValue, 229
- PrintHexXML
  - gdcM::ByteValue, 230
- PrintJobSOPClass
  - gdcM::UIDs, 1168
- PrintPNXML
  - gdcM::ByteValue, 230
- PrintQueueManagementSOPClassRetired
  - gdcM::UIDs, 1168
- PrintQueueSOPInstanceRetired
  - gdcM::UIDs, 1168
- PrintSelf
  - vtkGDCMImageReader, 1303
  - vtkGDCMImageReader2, 1318
  - vtkGDCMImageWriter, 1331
  - vtkGDCMMedicalImageProperties, 1339
  - vtkGDCMPolyDataReader, 1342
  - vtkGDCMPolyDataWriter, 1348
  - vtkGDCMTesting, 1353
  - vtkGDCMThreadedImageReader, 1356
  - vtkGDCMThreadedImageReader2, 1360
  - vtkImageColorViewer, 1373
  - vtkImageMapToColors16, 1384
  - vtkImageMapToWindowLevelColors2, 1390
  - vtkImagePlanarComponentsToComponents, 1393
  - vtkImageRGBToYBR, 1396
  - vtkImageYBRToRGB, 1398
  - vtkLookupTable16, 1402
  - vtkRTStructSetProperties, 1409
- PrintSQ
  - gdcM::Printer, 867
  - gdcM::XMLPrinter, 1430

- PrintStyle
  - gdcM::Printer, [868](#)
  - gdcM::XMLPrinter, [1431](#)
- PrintStyles
  - gdcM::Printer, [865](#)
  - gdcM::XMLPrinter, [1428](#)
- PrintTable
  - gdcM::network::ULTransitionTable, [1251](#)
  - gdcM::Scanner, [935](#)
  - gdcM::StrictScanner, [1043](#)
- PrintXML
  - gdcM::PrivateDict, [870](#)
- PrivateDict
  - gdcM::PrivateDict, [869](#)
- PrivateTag
  - gdcM::PrivateTag, [872](#), [873](#)
- ProceduralEventLoggingSOPClass
  - gdcM::UIDs, [1167](#)
- ProceduralEventLoggingSOPInstance
  - gdcM::UIDs, [1167](#)
- ProcedureLogStorage
  - gdcM::UIDs, [1170](#)
- Process
  - gdcM::Parser, [783](#)
- ProcessDataSet
  - gdcM::FileExplicitFilter, [468](#)
- ProcessPublicTag
  - gdcM::Scanner, [935](#)
  - gdcM::StrictScanner, [1043](#)
- ProcessRequest
  - vtkGDCMImageReader2, [1318](#)
- ProduceCharacterSetDataElement
  - gdcM::QueryFactory, [887](#)
- ProduceQuery
  - gdcM::QueryFactory, [887](#)
- ProductCharacteristicsQuerySOPClass
  - gdcM::UIDs, [1171](#)
- ProgressEvent
  - gdcM::ProgressEvent, [876](#)
- PropertyCategory
  - gdcM::Segment, [945](#)
- PropertyType
  - gdcM::Segment, [945](#)
- PropertyTypeModifiers
  - gdcM::Segment, [945](#)
- ProtocolApprovalInformationModelFIND
  - gdcM::UIDs, [1174](#)
- ProtocolApprovalInformationModelGET
  - gdcM::UIDs, [1174](#)
- ProtocolApprovalInformationModelMOVE
  - gdcM::UIDs, [1174](#)
- ProtocolApprovalStorage
  - gdcM::UIDs, [1174](#)
- PseudoColorSoftcopyPresentationStateStorageSOPClass
  - gdcM::UIDs, [1169](#)
- PubChemCompoundCID
  - gdcM::UIDs, [1172](#)
- PullPrintRequestSOPClassRetired
  - gdcM::UIDs, [1168](#)
- PullStoredPrintManagementMetaSOPClassRetired
  - gdcM::UIDs, [1168](#)
- Push
  - gdcM::TagPath, [1118](#)
- PushBackFile
  - vtkGDCMMedicalImageProperties, [1339](#)
- PVRGCodec
  - gdcM::PVRGCodec, [879](#)
- PythonFilter
  - gdcM::PythonFilter, [882](#)
- Quality
  - gdcM::JPEGCodec, [641](#)
- QueryFactory
  - gdcM::BaseQuery, [182](#)
  - gdcM::BaseRootQuery, [187](#)
  - gdcM::FindPatientRootQuery, [503](#)
  - gdcM::FindStudyRootQuery, [506](#)
  - gdcM::ModalityPerformedProcedureStepCreateQuery, [700](#)
  - gdcM::ModalityPerformedProcedureStepSetQuery, [703](#)
  - gdcM::MovePatientRootQuery, [717](#)
  - gdcM::MoveStudyRootQuery, [720](#)
  - gdcM::WLMFindQuery, [1418](#)
- RadiomicsOntology
  - gdcM::UIDs, [1172](#)
- RadiopharmaceuticalRadiationDoseSRStorage
  - gdcM::UIDs, [1174](#)
- RAWCodec
  - gdcM::RAWCodec, [899](#)
- RawDataStorage
  - gdcM::MediaStorage, [680](#)
  - gdcM::UIDs, [1169](#)
- Read
  - gdcM::BasicOffsetTable, [193](#)
  - gdcM::ByteValue, [230](#)
  - gdcM::CommandDataSet, [262](#)
  - gdcM::CP246ExplicitDataElement, [271](#)
  - gdcM::DataElement, [317](#)
  - gdcM::DataSet, [336](#)
  - gdcM::Element< TVR, TVM >, [399](#)
  - gdcM::Element< TVR, VM::VM1\_n >, [406](#)
  - gdcM::EncodingImplementation< VR::VRASCII >, [428](#)
  - gdcM::EncodingImplementation< VR::VRBINARY >, [430](#)
  - gdcM::ExplicitDataElement, [443](#)
  - gdcM::ExplicitImplicitDataElement, [446](#)



- gdcm::File, [451](#)
- gdcm::FileMetaInformation, [476](#)
- gdcm::Fragment, [509](#)
- gdcm::ImageReader, [577](#)
- gdcm::ImageRegionReader, [581](#)
- gdcm::ImplicitDataElement, [594](#)
- gdcm::Item, [614](#)
- gdcm::network::AAAbortPDU, [88](#)
- gdcm::network::AAAssociateACPDU, [93](#)
- gdcm::network::AAAssociateRJPDU, [96](#)
- gdcm::network::AAAssociateRQPDU, [101](#)
- gdcm::network::AbstractSyntax, [105](#)
- gdcm::network::ApplicationContext, [120](#)
- gdcm::network::AReleaseRPPDU, [125](#)
- gdcm::network::AReleaseRQPDU, [128](#)
- gdcm::network::AsynchronousOperationsWindowSub, [133](#)
- gdcm::network::BasePDU, [176](#)
- gdcm::network::ImplementationClassUIDSub, [589](#)
- gdcm::network::ImplementationVersionNameSub, [592](#)
- gdcm::network::MaximumLengthSub, [673](#)
- gdcm::network::PDataTFPDU, [787](#)
- gdcm::network::PresentationContextAC, [850](#)
- gdcm::network::PresentationContextRQ, [858](#)
- gdcm::network::PresentationDataValue, [861](#)
- gdcm::network::RoleSelectionSub, [926](#)
- gdcm::network::ServiceClassApplicationInformation, [981](#)
- gdcm::network::SOPClassExtendedNegotiationSub, [1008](#)
- gdcm::network::TransferSyntaxSub, [1140](#)
- gdcm::network::UserInformation, [1266](#)
- gdcm::PGXCodec, [805](#)
- gdcm::PixmapReader, [828](#)
- gdcm::PNMCodec, [839](#)
- gdcm::Preamble, [843](#)
- gdcm::Reader, [906](#)
- gdcm::SegmentReader, [951](#)
- gdcm::SequenceOfFragments, [963](#)
- gdcm::SequenceOfItems, [971](#)
- gdcm::StreamImageReader, [1027](#)
- gdcm::SurfaceReader, [1080](#)
- gdcm::TableReader, [1103](#)
- gdcm::Tag, [1113](#)
- gdcm::UNExplicitDataElement, [1256](#)
- gdcm::UNExplicitImplicitDataElement, [1258](#)
- gdcm::ValueIO< TDE, TSwap, TType >, [1273](#)
- gdcm::VL, [1280](#)
- gdcm::VR, [1293](#)
- gdcm::VR16ExplicitDataElement, [1295](#)
- gdcm::VRVLSize< 0 >, [1297](#)
- gdcm::VRVLSize< 1 >, [1298](#)
- Read16
  - gdcm::VL, [1280](#)
  - ReadACRNEMAIImage
    - gdcm::ImageReader, [577](#)
    - gdcm::PixmapReader, [828](#)
  - ReadBacktrack
    - gdcm::Fragment, [509](#)
  - ReadCompat
    - gdcm::FileMetaInformation, [477](#)
  - ReadCompatInternal
    - gdcm::FileMetaInformation, [477](#)
  - ReadComputeLength
    - gdcm::EncodingImplementation< VR::VRASCII >, [428](#)
    - gdcm::EncodingImplementation< VR::VRBINARY >, [430](#)
  - ReadDataSet
    - gdcm::Reader, [906](#)
  - Reader
    - gdcm::Reader, [905](#)
  - ReadFiles
    - vtkGDCMThreadedImageReader, [1356](#)
  - ReadFromCommaSeparatedString
    - gdcm::PrivateTag, [873](#)
    - gdcm::Tag, [1113](#)
  - ReadFromContinuousString
    - gdcm::Tag, [1113](#)
  - ReadFromPipeSeparatedString
    - gdcm::Tag, [1113](#)
  - ReadImage
    - gdcm::ImageReader, [577](#)
    - gdcm::PixmapReader, [828](#)
  - ReadImageInformation
    - gdcm::StreamImageReader, [1027](#)
  - ReadImageInternal
    - gdcm::PixmapReader, [828](#)
  - ReadInformation
    - gdcm::ImageRegionReader, [581](#)
  - ReadInto
    - gdcm::network::PDataTFPDU, [787](#)
    - gdcm::network::PresentationDataValue, [861](#)
  - ReadIntoBuffer
    - gdcm::ImageRegionReader, [581](#)
  - README.txt, [1713](#)
  - ReadMetaInformation
    - gdcm::Reader, [907](#)
  - ReadNested
    - gdcm::DataSet, [336](#)
  - ReadNoSwap
    - gdcm::EncodingImplementation< VR::VRASCII >, [428](#)
    - gdcm::EncodingImplementation< VR::VRBINARY >, [430](#)
  - ReadOrSkip
    - gdcm::DataElement, [317](#)

- ReadPointMacro
  - gdcm::SurfaceReader, 1080
- ReadPreamble
  - gdcm::Reader, 907
- ReadPreValue
  - gdcm::CP246ExplicitDataElement, 271
  - gdcm::DataElement, 318
  - gdcm::ExplicitDataElement, 443
  - gdcm::ExplicitImplicitDataElement, 446
  - gdcm::Fragment, 509
  - gdcm::ImplicitDataElement, 594
  - gdcm::SequenceOfFragments, 963
  - gdcm::UNExplicitDataElement, 1256
  - gdcm::UNExplicitImplicitDataElement, 1258
  - gdcm::VR16ExplicitDataElement, 1295
- ReadSegment
  - gdcm::SegmentReader, 952
- ReadSegments
  - gdcm::SegmentReader, 952
- ReadSelectedPrivateTags
  - gdcm::DataSet, 336
  - gdcm::Reader, 907
- ReadSelectedPrivateTagsWithLength
  - gdcm::DataSet, 337
- ReadSelectedTags
  - gdcm::DataSet, 337
  - gdcm::Reader, 907
- ReadSelectedTagsWithLength
  - gdcm::DataSet, 337
- ReadSurface
  - gdcm::SurfaceReader, 1080
- ReadSurfaces
  - gdcm::SurfaceReader, 1080
- Readuint16
  - gdcm::DictConverter, 366
- ReadUpToTag
  - gdcm::DataSet, 337
  - gdcm::Reader, 907
- ReadUpToTagWithLength
  - gdcm::DataSet, 337
- ReadValue
  - gdcm::CP246ExplicitDataElement, 271
  - gdcm::DataElement, 318
  - gdcm::ExplicitDataElement, 443
  - gdcm::ExplicitImplicitDataElement, 446
  - gdcm::Fragment, 509
  - gdcm::ImplicitDataElement, 594
  - gdcm::SequenceOfFragments, 963
  - gdcm::UNExplicitDataElement, 1256
  - gdcm::UNExplicitImplicitDataElement, 1258
  - gdcm::VR16ExplicitDataElement, 1295
- ReadValueWithLength
  - gdcm::DataElement, 318
  - gdcm::ImplicitDataElement, 595
- ReadVM
  - gdcm::DictConverter, 367
- ReadVR
  - gdcm::DictConverter, 367
- ReadWithLength
  - gdcm::CP246ExplicitDataElement, 272
  - gdcm::DataElement, 318
  - gdcm::DataSet, 338
  - gdcm::ExplicitDataElement, 443
  - gdcm::ExplicitImplicitDataElement, 446
  - gdcm::ImplicitDataElement, 595
  - gdcm::UNExplicitDataElement, 1256
  - gdcm::VR16ExplicitDataElement, 1296
- RealWorldValueIntercept
  - gdcm::RealWorldValueMappingContent, 911
- RealWorldValueMappingStorage
  - gdcm::UIDs, 1169
- RealWorldValueSlope
  - gdcm::RealWorldValueMappingContent, 911
- RecommendedDisplayCIELabToRGB
  - gdcm::SurfaceHelper, 1075
- RecurseDataSet
  - gdcm::Anonymizer, 115
- RED
  - gdcm::LookupTable, 660
- red
  - gdcm::terminal, 85
- reference
  - gdcm::CodeString, 254
  - gdcm::LO, 656
  - gdcm::String< TDelimiter, TMaxLength, TPadChar >, 1048
- ReferencedColorPrintManagementMetaSOPClassRetired
  - gdcm::UIDs, 1168
- ReferencedGrayscalePrintManagementMetaSOPClassRetired
  - gdcm::UIDs, 1168
- ReferencedImageBoxSOPClassRetired
  - gdcm::UIDs, 1168
- ReferenceFrameOfReferenceUID
  - vtkRTStructSetProperties, 1413
- ReferenceSeriesInstanceUID
  - vtkRTStructSetProperties, 1413
- Region
  - gdcm::Region, 912
- Register
  - gdcm::Object, 752
- Remove
  - gdcm::Anonymizer, 115
  - gdcm::DataSet, 338
  - gdcm::FileAnonymizer, 454
  - gdcm::Preamble, 843
- RemoveAllObservers
  - gdcm::Subject, 1058
- RemoveDictEntry



- gdcM::PrivateDict, [870](#)
- RemoveFile
  - gdcM::System, [1094](#)
- RemoveGroupLength
  - gdcM::Anonymizer, [115](#)
- RemoveItemByIndex
  - gdcM::SequenceOfItems, [971](#)
- RemoveObserver
  - gdcM::Subject, [1058](#)
- RemoveOverlay
  - gdcM::Pixmap, [823](#)
- RemovePrivateTags
  - gdcM::Anonymizer, [116](#)
- RemoveRetired
  - gdcM::Anonymizer, [116](#)
- Render
  - vtkImageColorViewer, [1373](#)
- Renderer
  - vtkImageColorViewer, [1380](#)
- RenderWindow
  - vtkImageColorViewer, [1381](#)
- Replace
  - gdcM::Anonymizer, [116](#)
  - gdcM::CommandDataSet, [262](#)
  - gdcM::DataSet, [338](#)
  - gdcM::FileAnonymizer, [455](#)
  - gdcM::FileMetaInformation, [477](#)
- ReplaceEmpty
  - gdcM::DataSet, [338](#)
- RequestData
  - vtkGDCMImageReader2, [1318](#)
  - vtkGDCMPolyDataReader, [1343](#)
  - vtkImageMapToColors16, [1384](#)
  - vtkImageMapToWindowLevelColors2, [1390](#)
  - vtkImagePlanarComponentsToComponents, [1394](#)
- RequestData\_HemodynamicWaveformStorage
  - vtkGDCMPolyDataReader, [1343](#)
- RequestData\_RTStructureSetStorage
  - vtkGDCMPolyDataReader, [1343](#)
- RequestDataCompat
  - vtkGDCMImageReader, [1303](#)
  - vtkGDCMImageReader2, [1318](#)
  - vtkGDCMThreadedImageReader, [1357](#)
- RequestInformation
  - vtkGDCMImageReader2, [1318](#)
  - vtkGDCMPolyDataReader, [1343](#)
  - vtkGDCMThreadedImageReader2, [1361](#)
  - vtkImageMapToColors16, [1384](#)
  - vtkImageMapToWindowLevelColors2, [1390](#)
- RequestInformation\_HemodynamicWaveformStorage
  - vtkGDCMPolyDataReader, [1343](#)
- RequestInformation\_RTStructureSetStorage
  - vtkGDCMPolyDataReader, [1343](#)
- RequestInformationCompat
  - vtkGDCMImageReader, [1303](#)
  - vtkGDCMImageReader2, [1319](#)
- RequestPaddedCompositePixelCode
  - gdcM::ImageCodec, [561](#)
- RequestPlanarConfiguration
  - gdcM::ImageCodec, [561](#)
- Rescale
  - gdcM::Rescaler, [917](#)
- RescaleFunctionIntoBestFit
  - gdcM::Rescaler, [917](#)
- Rescaler
  - gdcM::Rescaler, [915](#)
- ReserveDataElement
  - gdcM::FileStreamer, [496](#)
- ReserveGroupDataElement
  - gdcM::FileStreamer, [496](#)
- reset
  - gdcM::terminal, [85](#)
- ResetHandledDataSet
  - gdcM::network::ULConnectionCallback, [1237](#)
- RespiratoryWaveformStorage
  - gdcM::UIDs, [1173](#)
- RetrieveSOPInstanceUIDFromIndex
  - gdcM::DirectoryHelper, [392](#)
- RetrieveSOPInstanceUIDFromZPosition
  - gdcM::DirectoryHelper, [392](#)
- reverse
  - gdcM::terminal, [85](#)
- reverse\_iterator
  - gdcM::CodeString, [254](#)
  - gdcM::LO, [656](#)
  - gdcM::String< TDelimiter, TMaxLength, TPadChar >, [1048](#)
- RFC2557MIMEencapsulation
  - gdcM::UIDs, [1166](#)
- RGB
  - gdcM::PhotometricInterpretation, [808](#)
- RGB2YBR
  - gdcM::ImageChangePhotometricInterpretation, [538](#)
- RGBPixelsToRGBPlanes
  - gdcM::ImageChangePlanarConfiguration, [542](#)
- RGBPlanesToRGBPixels
  - gdcM::ImageChangePlanarConfiguration, [542](#)
- RGBToRecommendedDisplayCIELab
  - gdcM::SurfaceHelper, [1076](#)
- RGBToRecommendedDisplayGrayscale
  - gdcM::SurfaceHelper, [1076](#)
- RLE\_COMPRESSION
  - vtkGDCMImageWriter, [1330](#)
- RLECodec
  - gdcM::RLECodec, [920](#)
- RLELossless
  - gdcM::TransferSyntax, [1135](#)
  - gdcM::UIDs, [1166](#)

- ROI
  - gdcM::Overlay, 769
- RoleSelectionSub
  - gdcM::network::RoleSelectionSub, 925
- Round
  - gdcM, 75
- roundat
  - gdcM, 75
- RTBeamsDeliveryInstructionStorage
  - gdcM::UIDs, 1175
- RTBeamsDeliveryInstructionStorageSupplement74FrozenDraft
  - gdcM::UIDs, 1171
- RTBeamsTreatmentRecordStorage
  - gdcM::UIDs, 1170
- RTBrachyApplicationSetupDeliveryInstructionStorage
  - gdcM::UIDs, 1175
- RTBrachyTreatmentRecordStorage
  - gdcM::UIDs, 1170
- RTConventionalMachineVerification
  - gdcM::UIDs, 1175
- RTConventionalMachineVerificationSupplement74FrozenDraft
  - gdcM::UIDs, 1171
- RTDoseStorage
  - gdcM::MediaStorage, 680
  - gdcM::UIDs, 1170
- RTImageStorage
  - gdcM::MediaStorage, 680
  - gdcM::UIDs, 1170
- RTIonBeamsTreatmentRecordStorage
  - gdcM::MediaStorage, 681
  - gdcM::UIDs, 1170
- RTIonMachineVerification
  - gdcM::UIDs, 1175
- RTIonMachineVerificationSupplement74FrozenDraft
  - gdcM::UIDs, 1171
- RTIonPlanStorage
  - gdcM::MediaStorage, 681
  - gdcM::UIDs, 1170
- RTPhysicianIntentStorage
  - gdcM::UIDs, 1174
- RTPlanStorage
  - gdcM::MediaStorage, 680
  - gdcM::UIDs, 1170
- RTSegmentAnnotationStorage
  - gdcM::UIDs, 1174
- RTStructSetProperties
  - vtkGDCMPolyDataReader, 1345
  - vtkGDCMPolyDataWriter, 1350
- RTStructureSetStorage
  - gdcM::MediaStorage, 680
  - gdcM::UIDs, 1170
- RTTreatmentSummaryRecordStorage
  - gdcM::MediaStorage, 681
  - gdcM::UIDs, 1170
- Rule
  - gdcM::SerieHelper, 975
- RunEventLoop
  - gdcM::network::ULConnectionManager, 1243
- RunMoveEventLoop
  - gdcM::network::ULConnectionManager, 1244
- SAGITTAL
  - gdcM::Orientation, 764
- ScalarType
  - gdcM::PixelFormat, 812
- Scale
  - vtkGDCMImageReader, 1313
  - vtkGDCMImageReader2, 1327
- Scan
  - gdcM::Scanner, 935
  - gdcM::StrictScanner, 1044
- Scanner
  - gdcM::Scanner, 930
- SecondaryCaptureImageStorage
  - gdcM::MediaStorage, 680
  - gdcM::UIDs, 1169
- Segment
  - gdcM::Segment, 939
- SegmentAlgorithmName
  - gdcM::Segment, 945
- SegmentAlgorithmType
  - gdcM::Segment, 945
- Segmentation
  - gdcM::MediaStorage, 682
- SegmentationStorage
  - gdcM::MediaStorage, 681
  - gdcM::UIDs, 1169
- SegmentDescription
  - gdcM::Segment, 945
- SegmentedPaletteColorLookupTable
  - gdcM::SegmentedPaletteColorLookupTable, 947
- SegmentedVolumeRenderingVolumetricPresentationStateStorage
  - gdcM::UIDs, 1173
- SegmentLabel
  - gdcM::Segment, 945
- SegmentMap
  - gdcM::SegmentReader, 950
- SegmentNumber
  - gdcM::Segment, 946
- SegmentReader
  - gdcM::SegmentReader, 951
- Segments
  - gdcM::SegmentReader, 952
  - gdcM::SegmentWriter, 956
- SegmentVector
  - gdcM::SegmentReader, 951
  - gdcM::SegmentWriter, 954
- SegmentWriter

- gdcM::SegmentWriter, [954](#)
- Selection
  - gdcM::Sorter, [1015](#)
- SelectionMap
  - gdcM::Sorter, [1013](#)
- Self
  - gdcM::AnonymizeEvent, [108](#)
  - gdcM::DataEvent, [325](#)
  - gdcM::DataSetEvent, [342](#)
  - gdcM::FileNameEvent, [485](#)
  - gdcM::MemberCommand< T >, [688](#)
  - gdcM::ProgressEvent, [876](#)
  - gdcM::SimpleMemberCommand< T >, [994](#)
- SEMIAUTOMATIC
  - gdcM::Segment, [939](#)
- SendEcho
  - gdcM::network::ULConnectionManager, [1244](#)
  - gdcM::ServiceClassUser, [986](#)
- SendFind
  - gdcM::network::ULConnectionManager, [1244](#)
  - gdcM::ServiceClassUser, [986](#)
- SendMove
  - gdcM::network::ULConnectionManager, [1244](#)
  - gdcM::ServiceClassUser, [986, 987](#)
- SendNAction
  - gdcM::network::ULConnectionManager, [1245](#)
- SendNCreate
  - gdcM::network::ULConnectionManager, [1245](#)
- SendNDelete
  - gdcM::network::ULConnectionManager, [1245](#)
- SendNEventReport
  - gdcM::network::ULConnectionManager, [1246](#)
- SendNGet
  - gdcM::network::ULConnectionManager, [1246](#)
- SendNSet
  - gdcM::network::ULConnectionManager, [1246](#)
- SendStore
  - gdcM::network::ULConnectionManager, [1247](#)
  - gdcM::ServiceClassUser, [987](#)
- Separator
  - gdcM::ApplicationEntity, [123](#)
  - gdcM::PersonName, [803](#)
- SequenceLengthField
  - gdcM::SequenceOfItems, [973](#)
- SequenceOfFragments
  - gdcM::SequenceOfFragments, [959](#)
- SequenceOfItems
  - gdcM::SequenceOfItems, [967](#)
- SerieHelper
  - gdcM::SerieHelper, [975](#)
- SerieRestrictions
  - gdcM::SerieHelper, [975](#)
- Series
  - gdcM::Series, [980](#)
- SeriesInstanceUID
  - vtkRTStructSetProperties, [1413](#)
- ServiceClassApplicationInformation
  - gdcM::network::ServiceClassApplicationInformation, [980](#)
- ServiceClassUser
  - gdcM::ServiceClassUser, [984](#)
- Set
  - gdcM::Attribute< Group, Element, TVR, TVM >, [141](#)
  - gdcM::Attribute< Group, Element, TVR, VM::VM1 >, [149](#)
  - gdcM::Attribute< Group, Element, TVR, VM::VM1\_n >, [158](#)
  - gdcM::Element< TVR, TVM >, [399](#)
  - gdcM::Element< TVR, VM::VM1\_n >, [406](#)
- SetAbstractSyntax
  - gdcM::network::PresentationContextRQ, [858](#)
  - gdcM::PresentationContext, [848](#)
- SetAETitle
  - gdcM::ServiceClassUser, [987](#)
- SetAlgorithmFamily
  - gdcM::Surface, [1069](#)
- SetAlgorithmName
  - gdcM::Surface, [1069](#)
- SetAlgorithmVersion
  - gdcM::Surface, [1069](#)
- SetAnatomicRegion
  - gdcM::Segment, [942](#)
- SetAnatomicRegionModifiers
  - gdcM::Segment, [942](#)
- SetAppendDerivationHistory
  - gdcM::FileDerivation, [465](#)
- SetArray
  - gdcM::Element< TVR, VM::VM1\_n >, [406](#)
- setAttribute
  - gdcM::terminal, [86](#)
- SetAxisOfRotation
  - gdcM::Surface, [1069](#)
- setbgcolor
  - gdcM::terminal, [86](#)
- SetBitPosition
  - gdcM::Overlay, [774](#)
- SetBitsAllocated
  - gdcM::Overlay, [774](#)
  - gdcM::PixelFormat, [817](#)
- SetBitSample
  - gdcM::JPEGCodec, [639](#)
- SetBitsStored
  - gdcM::PixelFormat, [817](#)
- SetBlob
  - gdcM::ApplicationEntity, [122](#)
  - gdcM::network::PresentationDataValue, [862](#)
  - gdcM::PersonName, [802](#)
- SetBlueLUT

- gdcM::LookupTable, [664](#)
- SetBufferLength
  - gdcM::JPEGLSCodec, [647](#)
  - gdcM::PNMCodec, [840](#)
  - gdcM::RLECodec, [924](#)
- SetByteSwapTag
  - gdcM::ByteSwapFilter, [222](#)
- SetByteValue
  - gdcM::Attribute< Group, Element, TVR, TVM >, [141](#)
  - gdcM::Attribute< Group, Element, TVR, VM::VM1 >, [149](#)
  - gdcM::Attribute< Group, Element, TVR, VM::VM1\_n >, [158](#)
  - gdcM::CSAElement, [283](#)
  - gdcM::DataElement, [318](#)
- SetByteValueNoSwap
  - gdcM::Attribute< Group, Element, TVR, TVM >, [141](#)
  - gdcM::Attribute< Group, Element, TVR, VM::VM1 >, [149](#)
- SetCallbackFunction
  - gdcM::MemberCommand< T >, [691](#)
  - gdcM::SimpleMemberCommand< T >, [996](#)
- SetCalledAETitle
  - gdcM::network::AAssociateACPDU, [93](#)
  - gdcM::network::AAssociateRQPDU, [102](#)
  - gdcM::ServiceClassUser, [988](#)
- SetCallingAETitle
  - gdcM::network::AAssociateACPDU, [93](#)
  - gdcM::network::AAssociateRQPDU, [102](#)
- SetCenterOfRotation
  - gdcM::Surface, [1069](#)
- SetChangePrivateTags
  - gdcM::FileExplicitFilter, [469](#)
- SetCheckFileMetaInformation
  - gdcM::Writer, [1422](#)
- SetCipherType
  - gdcM::CAPICryptographicMessageSyntax, [236](#)
  - gdcM::CryptographicMessageSyntax, [277](#)
  - gdcM::OpenSSLCryptographicMessageSyntax, [757](#)
  - gdcM::OpenSSL7CryptographicMessageSyntax, [762](#)
- SetColor
  - gdcM::Printer, [867](#)
- SetColorLevel
  - vtkImageColorViewer, [1373](#)
- SetColorWindow
  - vtkImageColorViewer, [1373](#)
- SetColumns
  - gdcM::Bitmap, [202](#)
  - gdcM::Overlay, [774](#)
- SetCommand
  - gdcM::network::PresentationDataValue, [862](#)
- SetComponents
  - gdcM::PersonName, [802](#)
- SetCompressIconImage
  - gdcM::ImageChangeTransferSyntax, [546](#)
- SetComputeZSpacing
  - gdcM::IPPSorter, [608](#)
- SetCoordinateStartValue
  - gdcM::Curve, [307](#)
- SetCoordinateStepValue
  - gdcM::Curve, [307](#)
- SetCryptographicMessageSyntax
  - gdcM::Anonymizer, [117](#)
- SetCurve
  - gdcM::Curve, [307](#)
  - vtkGDCMImageReader, [1303](#)
  - vtkGDCMImageReader2, [1319](#)
- SetCurveDataDescriptor
  - gdcM::Curve, [307](#)
- SetCurveDescription
  - gdcM::Curve, [307](#)
- SetData
  - gdcM::DataEvent, [327](#)
- SetDataElement
  - gdcM::Bitmap, [202](#)
- SetDataSet
  - gdcM::File, [451](#)
  - gdcM::network::PresentationDataValue, [862](#)
- SetDataSetTransferSyntax
  - gdcM::FileMetaInformation, [477](#)
- SetDataValueRepresentation
  - gdcM::Curve, [308](#)
- SetDebug
  - gdcM::Trace, [1130](#)
- SetDebugStream
  - gdcM::Trace, [1130](#)
- SetDefaultTransferSyntax
  - gdcM::PresentationContextGenerator, [854](#)
- SetDerivationCodeSequenceCodeValue
  - gdcM::FileDerivation, [465](#)
- SetDerivationDescription
  - gdcM::FileDerivation, [466](#)
- SetDescription
  - gdcM::CSAHeaderDictEntry, [298](#)
  - gdcM::ModuleEntry, [711](#)
  - gdcM::Overlay, [774](#)
- SetDescriptor
  - gdcM::DICOMDIRGenerator, [358](#)
- SetDictName
  - gdcM::DictConverter, [367](#)
- SetDicts
  - gdcM::PythonFilter, [882](#)
  - gdcM::StringFilter, [1053](#)
- SetDimension
  - gdcM::Bitmap, [203](#)
- SetDimensions
  - gdcM::Bitmap, [203](#)

- gdcM::Curve, 308
- gdcM::ImageCodec, 557
- SetDimensionsValue
  - gdcM::ImageHelper, 572
- SetDirectionCosines
  - gdcM::Image, 529, 530
  - vtkGDCMImageWriter, 1331
- SetDirectionCosinesFromImageOrientationPatient
  - vtkGDCMImageWriter, 1331
- SetDirectionCosinesTolerance
  - gdcM::IPPSorter, 608
- SetDirectionCosinesValue
  - gdcM::ImageHelper, 572
- SetDirectory
  - gdcM::network::ULWritingCallback, 1253
  - gdcM::SerieHelper, 978
- SetDisplayId
  - vtkImageColorViewer, 1373
- SetDomain
  - gdcM::BoxRegion, 217
- SetDropDuplicatePositions
  - gdcM::IPPSorter, 608
- SetElement
  - gdcM::Tag, 1113
- SetElementHandler
  - gdcM::Parser, 783
- SetElementTag
  - gdcM::Tag, 1114
- SetElementXX
  - gdcM::DictEntry, 371
- SetError
  - gdcM::Trace, 1130
- SetErrorStream
  - gdcM::Trace, 1131
- SetEvent
  - gdcM::network::ULEvent, 1250
- setfgcolor
  - gdcM::terminal, 86
- SetFile
  - gdcM::Anonymizer, 117
  - gdcM::DICOmdirGenerator, 358
  - gdcM::FileDecompressLookupTable, 462
  - gdcM::FileDerivation, 466
  - gdcM::FileExplicitFilter, 469
  - gdcM::IconImageFilter, 520
  - gdcM::Printer, 867
  - gdcM::PythonFilter, 882
  - gdcM::Reader, 908
  - gdcM::SplitMosaicFilter, 1022
  - gdcM::StreamImageWriter, 1032
  - gdcM::StringFilter, 1053
  - gdcM::Validate, 1268
  - gdcM::Writer, 1422
  - gdcM::XMLPrinter, 1430
- SetFileName
  - gdcM::FileNameEvent, 486
  - gdcM::Reader, 908
  - gdcM::StreamImageReader, 1028
  - gdcM::StreamImageWriter, 1032
  - gdcM::Writer, 1422
  - vtkGDCMThreadedImageReader2, 1361
- SetFilename
  - gdcM::TableReader, 1103
- SetFileNames
  - vtkGDCMImageReader, 1304
  - vtkGDCMImageWriter, 1332
  - vtkGDCMThreadedImageReader2, 1361
- SetFilenames
  - gdcM::DICOmdirGenerator, 358
- SetFilePattern
  - vtkGDCMImageReader, 1304
  - vtkGDCMImageReader2, 1319
- SetFilePrefix
  - vtkGDCMImageReader, 1304
  - vtkGDCMImageReader2, 1319
- SetFiles
  - gdcM::FileSet, 493
- SetFiniteVolume
  - gdcM::Surface, 1069
- SetForce
  - gdcM::ImageChangeTransferSyntax, 546
  - gdcM::ImageFragmentSplitter, 566
- SetForcePixelSpacing
  - gdcM::ImageHelper, 572
- SetForceRescaleInterceptSlope
  - gdcM::ImageHelper, 572
- SetFragmentSizeMax
  - gdcM::ImageFragmentSplitter, 566
- SetFrameOrigin
  - gdcM::Overlay, 775
- SetFromDataElement
  - gdcM::Attribute< Group, Element, TVR, TVM >, 142
  - gdcM::Attribute< Group, Element, TVR, VM::VM1 >, 149
  - gdcM::Attribute< Group, Element, TVR, VM::VM1\_n >, 158
  - gdcM::Element< TVR, TVM >, 399
  - gdcM::Element< TVR, VM::VM1\_n >, 407
- SetFromDataSet
  - gdcM::Attribute< Group, Element, TVR, TVM >, 142
  - gdcM::Attribute< Group, Element, TVR, VM::VM1 >, 150
  - gdcM::Attribute< Group, Element, TVR, VM::VM1\_n >, 158
  - gdcM::MediaStorage, 685
- SetFromFile
  - gdcM::MediaStorage, 685
- SetFromHeader

- gdcM::MediaStorage, 685
- SetFromModality
  - gdcM::MediaStorage, 685
- SetFromSourceImageSequence
  - gdcM::MediaStorage, 686
- SetFromString
  - gdcM::DirectionCosines, 385
- SetFromUID
  - gdcM::UIDs, 1186
- SetGreenLUT
  - gdcM::LookupTable, 665
- SetGroup
  - gdcM::Curve, 308
  - gdcM::Overlay, 775
  - gdcM::Tag, 1114
- SetGroupXX
  - gdcM::DictEntry, 371
- SetHeader
  - gdcM::File, 451
- SetHighBit
  - gdcM::PixelFormat, 817
- SetHostname
  - gdcM::ServiceClassUser, 988
- SetIconImage
  - gdcM::Pixmap, 823
- SetIE
  - gdcM::IODEntry, 601
- SetImage
  - gdcM::PixmapWriter, 835
  - gdcM::SplitMosaicFilter, 1022
- SetImplementationClassUID
  - gdcM::FileMetaInformation, 477
- SetImplementationVersionName
  - gdcM::FileMetaInformation, 478
- SetImplicitFlag
  - gdcM::network::ULConnectionCallback, 1237
- SetInput
  - gdcM::BitmapToBitmapFilter, 211
  - gdcM::ImageConverter, 563
  - vtkImageColorViewer, 1374
- SetInputConnection
  - vtkImageColorViewer, 1374
- SetInputDirectory
  - gdcM::EmptyMaskGenerator, 425
- SetInputFileName
  - gdcM::DictConverter, 367
  - gdcM::FileAnonymizer, 455
  - gdcM::FileChangeTransferSyntax, 459
- SetIntercept
  - gdcM::Image, 530
  - gdcM::Rescaler, 917
- SetKey
  - gdcM::CSAElement, 283
- SetKeyword
  - gdcM::DictEntry, 371
- SetLastElement
  - gdcM::ParseException, 779
- SetLastFragment
  - gdcM::network::PresentationDataValue, 862
- SetLength
  - gdcM::ByteValue, 230
  - gdcM::Element< TVR, VM::VM1\_2 >, 402
  - gdcM::Element< TVR, VM::VM1\_n >, 407
  - gdcM::Element< TVR, VM::VM2\_2n >, 409
  - gdcM::Element< TVR, VM::VM2\_n >, 411
  - gdcM::Element< TVR, VM::VM3\_3n >, 413
  - gdcM::Element< TVR, VM::VM3\_4 >, 415
  - gdcM::Element< TVR, VM::VM3\_n >, 417
  - gdcM::RLECodec, 924
  - gdcM::SequenceOfFragments, 963
  - gdcM::SequenceOfItems, 972
  - gdcM::Value, 1272
- SetLengthOnly
  - gdcM::ByteValue, 230
  - gdcM::Value, 1272
- SetLengthToUndefined
  - gdcM::SequenceOfItems, 972
- SetLoadMode
  - gdcM::SerieHelper, 978
- SetLookupTable
  - vtkImageMapToColors16, 1384
- SetLossless
  - gdcM::JPEGCodec, 639
  - gdcM::JPEGLSCodec, 647
- SetLossyError
  - gdcM::JPEGLSCodec, 647
- SetLossyFlag
  - gdcM::Bitmap, 203
  - gdcM::ImageCodec, 557
  - gdcM::PVRGCodec, 881
- SetLUT
  - gdcM::Bitmap, 203
  - gdcM::ImageCodec, 558
  - gdcM::LookupTable, 665
  - gdcM::SegmentedPaletteColorLookupTable, 948
- SetManifold
  - gdcM::Surface, 1070
- SetMaximumLength
  - gdcM::network::MaximumLengthSub, 674
- SetMaximumPointDistance
  - gdcM::Surface, 1070
- SetMaxPDULength
  - gdcM::network::ULConnectionInfo, 1240
- SetMaxPDUSize
  - gdcM::network::ULConnection, 1234
- SetMCT
  - gdcM::JPEG2000Codec, 627
- SetMeanPointDistance



- gdcM::Surface, 1070
- SetMedicalImageProperties
  - vtkGDCMImageReader, 1304
  - vtkGDCMImageReader2, 1319
  - vtkGDCMImageWriter, 1332
  - vtkGDCMPolyDataWriter, 1348
- SetMergeModeToAbstractSyntax
  - gdcM::PresentationContextGenerator, 854
- SetMergeModeToTransferSyntax
  - gdcM::PresentationContextGenerator, 855
- SetMeshPrimitive
  - gdcM::Surface, 1070
- SetMessageHeader
  - gdcM::network::PresentationDataValue, 862
- SetMinMaxForPixelType
  - gdcM::Rescaler, 917
- setmode
  - gdcM::terminal, 86
- SetName
  - gdcM::CSAElement, 284
  - gdcM::CSAHeaderDictEntry, 298
  - gdcM::DictEntry, 371
  - gdcM::IODEntry, 601
  - gdcM::Macro, 669
  - gdcM::Module, 707
  - gdcM::ModuleEntry, 711
  - gdcM::network::AbstractSyntax, 106
  - gdcM::network::ApplicationContext, 120
  - gdcM::network::TransferSyntaxSub, 1140
  - gdcM::PDBElement, 790
- SetNameFromUID
  - gdcM::network::AbstractSyntax, 106
  - gdcM::network::TransferSyntaxSub, 1140
- SetNeedByteSwap
  - gdcM::Bitmap, 204
  - gdcM::ImageCodec, 558
- SetNeedOverlayCleanup
  - gdcM::ImageCodec, 558
- SetNestedDataSet
  - gdcM::Item, 614
- SetNoOfItems
  - gdcM::CSAElement, 284
- SetNoSwap
  - gdcM::Element< TVR, TVM >, 400
  - gdcM::Element< TVR, VM::VM1\_n >, 407
- SetNumberOfCurves
  - gdcM::Pixmap, 823
- SetNumberOfDimensions
  - gdcM::Bitmap, 204
  - gdcM::ImageCodec, 558
- SetNumberOfFilenames
  - gdcM::FilenameGenerator, 490
- SetNumberOfFrames
  - gdcM::Overlay, 775
- SetNumberOfInputPorts
  - vtkGDCMPolyDataWriter, 1348
- SetNumberOfItems
  - gdcM::SequenceOfItems, 972
- SetNumberOfOverlays
  - gdcM::Pixmap, 823
- SetNumberOfPoints
  - gdcM::Curve, 308
- SetNumberOfResolutions
  - gdcM::JPEG2000Codec, 627
- SetNumberOfSegments
  - gdcM::SegmentWriter, 955
- SetNumberOfSurfacePoints
  - gdcM::Surface, 1070
- SetNumberOfSurfaces
  - gdcM::SurfaceWriter, 1083
- SetNumberOfTableValues
  - vtkLookupTable16, 1402
- SetNumberOfThreadsForDecompression
  - gdcM::JPEG2000Codec, 627
- SetNumberOfValues
  - gdcM::Attribute< Group, Element, TVR, VM::VM1\_n >, 158
- SetNumberOfVectors
  - gdcM::Surface, 1070
- SetObliquityThresholdCosineValue
  - gdcM::Orientation, 766
- SetOffScreenRendering
  - vtkImageColorViewer, 1374
- SetOrigin
  - gdcM::Image, 530, 531
  - gdcM::Overlay, 775
- SetOriginValue
  - gdcM::ImageHelper, 573
- SetOutputDimensions
  - gdcM::IconImageGenerator, 523
- SetOutputDirectory
  - gdcM::EmptyMaskGenerator, 426
- SetOutputFileName
  - gdcM::DictConverter, 367
  - gdcM::FileAnonymizer, 455
  - gdcM::FileChangeTransferSyntax, 459
  - gdcM::FileStreamer, 497
- SetOutputFormatToLuminance
  - vtkImageMapToColors16, 1385
- SetOutputFormatToLuminanceAlpha
  - vtkImageMapToColors16, 1385
- SetOutputFormatToRGB
  - vtkImageMapToColors16, 1385
- SetOutputFormatToRGBA
  - vtkImageMapToColors16, 1385
- SetOutputType
  - gdcM::DictConverter, 367
- SetOutsideValuePixel

- gdcM::IconImageGenerator, 523
- SetOverlay
  - gdcM::Overlay, 775
- SetOverlayVisibility
  - vtkImageColorViewer, 1374
- SetOwner
  - gdcM::PrivateTag, 874
- SetParentId
  - vtkImageColorViewer, 1374
- SetPassword
  - gdcM::CAPICryptographicMessageSyntax, 236
  - gdcM::CryptographicMessageSyntax, 278
  - gdcM::OpenSSLCryptographicMessageSyntax, 757
  - gdcM::OpenSSL7CryptographicMessageSyntax, 762
- SetPattern
  - gdcM::FilenameGenerator, 490
- SetPDU
  - gdcM::network::ULEvent, 1250
- SetPermissions
  - gdcM::System, 1094
- SetPhotometricInterpretation
  - gdcM::Bitmap, 204
  - gdcM::ImageChangePhotometricInterpretation, 538
  - gdcM::ImageCodec, 558
- SetPixelFormat
  - gdcM::Bitmap, 204
  - gdcM::ImageCodec, 559
  - gdcM::JPEGCodec, 640
  - gdcM::Rescaler, 918
- SetPixelMinMax
  - gdcM::IconImageGenerator, 523
- SetPixelRepresentation
  - gdcM::PixelFormat, 817
- SetPixmap
  - gdcM::FileDecompressLookupTable, 462
  - gdcM::IconImageGenerator, 524
  - gdcM::PixmapWriter, 836
- SetPlanarConfiguration
  - gdcM::Bitmap, 205
  - gdcM::ImageChangePlanarConfiguration, 542
  - gdcM::ImageCodec, 559
- SetPMSRescaleInterceptSlope
  - gdcM::ImageHelper, 573
- SetPointCoordinatesData
  - gdcM::Surface, 1071
- SetPointPositionAccuracy
  - gdcM::Surface, 1071
- SetPointsBoundingBoxCoordinates
  - gdcM::Surface, 1071
- SetPort
  - gdcM::ServiceClassUser, 988
- SetPortSCP
  - gdcM::ServiceClassUser, 988
- SetPosition
  - vtkImageColorViewer, 1374, 1375
- SetPreamble
  - gdcM::FileMetaInformation, 478
- SetPrefix
  - gdcM::FilenameGenerator, 490
- SetPresentationContextID
  - gdcM::network::PresentationContextAC, 850
  - gdcM::network::PresentationContextRQ, 858
  - gdcM::network::PresentationDataValue, 863
  - gdcM::PresentationContext, 848
- SetPresentationContexts
  - gdcM::network::ULConnection, 1234
  - gdcM::ServiceClassUser, 989
- SetPrettyPrint
  - gdcM::JSON, 650
- SetPrimitiveData
  - gdcM::MeshPrimitive, 697
- SetPrimitivesData
  - gdcM::MeshPrimitive, 697
- SetPrimitiveType
  - gdcM::MeshPrimitive, 697
- SetPrivateCreator
  - gdcM::Tag, 1114
- SetProcessingAlgorithm
  - gdcM::Surface, 1071
- SetProgress
  - gdcM::ProgressEvent, 877
- SetPropertyCategory
  - gdcM::Segment, 943
- SetPropertyType
  - gdcM::Segment, 943
- SetPropertyTypeModifiers
  - gdcM::Segment, 943
- SetPurposeOfReferenceCodeSequenceCodeValue
  - gdcM::FileDerivation, 466
- SetQuality
  - gdcM::JPEG2000Codec, 628
  - gdcM::JPEGCodec, 640
- SetRate
  - gdcM::JPEG2000Codec, 628
- SetReason
  - gdcM::network::AAbortPDU, 89
  - gdcM::network::PresentationContextAC, 851
- SetRecommendedDisplayCIELabValue
  - gdcM::Surface, 1071, 1072
- SetRecommendedDisplayGrayscaleValue
  - gdcM::Surface, 1072
- SetRecommendedPresentationOpacity
  - gdcM::Surface, 1072
- SetRecommendedPresentationType
  - gdcM::Surface, 1072
- SetRecomputeItemLength
  - gdcM::FileExplicitFilter, 469



SetRecomputeSequenceLength  
gdcM::FileExplicitFilter, 469

SetRedLUT  
gdcM::LookupTable, 665

SetRef  
gdcM::IODEntry, 601

SetRegion  
gdcM::ImageRegionReader, 582

SetRenderer  
vtkImageColorViewer, 1375

SetRenderWindow  
vtkImageColorViewer, 1375

SetRescaleInterceptSlopeValue  
gdcM::ImageHelper, 573

SetRetired  
gdcM::DictEntry, 372

SetReversible  
gdcM::JPEG2000Codec, 628

SetRGB8  
gdcM::ImageApplyLookupTable, 534

SetRoot  
gdcM::UIDGenerator, 1149

SetRootDirectory  
gdcM::DICOMDIRGenerator, 358

SetRows  
gdcM::Bitmap, 205  
gdcM::Overlay, 776

SetRTStructSetProperties  
vtkGDCMPolyDataWriter, 1348

SetSamplesPerPixel  
gdcM::PixelFormat, 817

SetScalarType  
gdcM::PixelFormat, 818

SetSearchParameter  
gdcM::BaseQuery, 180, 181

SetSegmentAlgorithmName  
gdcM::Segment, 943

SetSegmentAlgorithmType  
gdcM::Segment, 943

SetSegmentDescription  
gdcM::Segment, 944

SetSegmentLabel  
gdcM::Segment, 944

SetSegmentNumber  
gdcM::Segment, 944

SetSegments  
gdcM::SegmentWriter, 956

SetSize  
vtkImageColorViewer, 1375

SetSlice  
vtkImageColorViewer, 1376

SetSliceOrientation  
vtkImageColorViewer, 1376

SetSliceOrientationToXY  
vtkImageColorViewer, 1376

SetSliceOrientationToXZ  
vtkImageColorViewer, 1376

SetSliceOrientationToYZ  
vtkImageColorViewer, 1376

SetSlope  
gdcM::Image, 531  
gdcM::Rescaler, 918

SetSOPClassUIDMode  
gdcM::EmptyMaskGenerator, 426

SetSOPInstanceUID  
gdcM::BaseQuery, 181

SetSortFunction  
gdcM::Sorter, 1014

SetSource  
gdcM::network::AAbortPDU, 89

SetSourceApplicationEntityTitle  
gdcM::FileMetaInformation, 478

SetSpacing  
gdcM::Image, 531

SetSpacingValue  
gdcM::ImageHelper, 573

SetState  
gdcM::network::ULConnection, 1234

SetStream  
gdcM::Reader, 908  
gdcM::StreamImageReader, 1028  
gdcM::StreamImageWriter, 1032  
gdcM::Trace, 1131  
gdcM::Writer, 1423

SetStreamToFile  
gdcM::Trace, 1131

SetStyle  
gdcM::Printer, 867  
gdcM::XMLPrinter, 1430

SetSurfaceComments  
gdcM::Surface, 1072

SetSurfaceCount  
gdcM::Segment, 944

SetSurfaceNumber  
gdcM::Surface, 1072

SetSurfaceProcessing  
gdcM::Surface, 1073

SetSurfaceProcessingDescription  
gdcM::Surface, 1073

SetSurfaceProcessingRatio  
gdcM::Surface, 1073

SetSyngoDT  
gdcM::CSAElement, 284

SetTag  
gdcM::AnonymizeEvent, 110  
gdcM::DataElement, 319

SetTagsToRead  
gdcM::Sorter, 1014

- SetTargetPixelType
  - gdcm::Rescaler, 918
- SetTemplateFileName
  - gdcm::FileStreamer, 497
- SetTileSize
  - gdcm::JPEG2000Codec, 628
- SetTimeout
  - gdcm::network::ARTIMTimer, 130
  - gdcm::ServiceClassUser, 989
- SetToUndefined
  - gdcm::VL, 1280
- SetTransferSyntax
  - gdcm::Bitmap, 205
  - gdcm::FileChangeTransferSyntax, 459
  - gdcm::ImageChangeTransferSyntax, 546
  - gdcm::network::PresentationContextAC, 851
- SetTuple
  - gdcm::network::RoleSelectionSub, 926
  - gdcm::network::ServiceClassApplicationInformation, 981
  - gdcm::network::SOPClassExtendedNegotiationSub, 1008
- SetType
  - gdcm::ModuleEntry, 711
  - gdcm::Overlay, 776
- SetTypeOfData
  - gdcm::Curve, 308
- SetupInteractor
  - vtkImageColorViewer, 1376
- SetUsage
  - gdcm::IODEntry, 602
- SetUserCodec
  - gdcm::ImageChangeTransferSyntax, 547
- SetUserData
  - gdcm::Parser, 784
- SetUserInformation
  - gdcm::network::AAAssociateRQPDU, 102
- SetUseSeriesDetails
  - gdcm::SerieHelper, 978
- SetUseTargetPixelType
  - gdcm::Rescaler, 918
- SetUseVRUN
  - gdcm::FileExplicitFilter, 469
- SetValue
  - gdcm::Attribute< Group, Element, TVR, TVM >, 142
  - gdcm::Attribute< Group, Element, TVR, VM::VM1 >, 150
  - gdcm::Attribute< Group, Element, TVR, VM::VM1\_n >, 159
  - gdcm::CSAElement, 284
  - gdcm::DataElement, 319
  - gdcm::Element< TVR, TVM >, 400
  - gdcm::Element< TVR, VM::VM1\_n >, 407
  - gdcm::PDBElement, 790
- SetValueFieldLength
  - gdcm::DataElement, 320
- SetValues
  - gdcm::Attribute< Group, Element, TVR, TVM >, 143
  - gdcm::Attribute< Group, Element, TVR, VM::VM1\_n >, 159
- SetVectorAccuracy
  - gdcm::Surface, 1073
- SetVectorCoordinateData
  - gdcm::Surface, 1073
- SetVectorDimensionality
  - gdcm::Surface, 1073
- SetVL
  - gdcm::DataElement, 320
- SetVLToUndefined
  - gdcm::DataElement, 320
- SetVM
  - gdcm::CSAElement, 284
  - gdcm::CSAHeaderDictEntry, 298
  - gdcm::DictEntry, 372
- SetVR
  - gdcm::CSAElement, 284
  - gdcm::CSAHeaderDictEntry, 298
  - gdcm::DataElement, 320
  - gdcm::DictEntry, 372
- SetWarning
  - gdcm::Trace, 1131
- SetWarningStream
  - gdcm::Trace, 1131
- SetWindowId
  - vtkImageColorViewer, 1377
- SetWriteDataSetOnly
  - gdcm::Writer, 1423
- SetZSpacingTolerance
  - gdcm::IPPSorter, 609
- SH
  - gdcm::VR, 1288
- SHA1
  - gdcm::SHA1, 991
- SHComp
  - gdcm, 59
- Shift
  - vtkGDCMImageReader, 1313
  - vtkGDCMImageReader2, 1327
- ShiftEnd
  - gdcm::ByteBuffer, 218
- ShowAbort
  - gdcm::SimpleSubjectWatcher, 998
- ShowAnonymization
  - gdcm::SimpleSubjectWatcher, 999
- ShowData
  - gdcm::SimpleSubjectWatcher, 999
- ShowDataSet
  - gdcm::SimpleSubjectWatcher, 999

- ShowFileName
  - gdcm::SimpleSubjectWatcher, 999
- ShowIteration
  - gdcm::SimpleSubjectWatcher, 999
- ShowProgress
  - gdcm::SimpleSubjectWatcher, 1000
- SIEMENS
  - gdcm::Dicts, 377
  - gdcm::EquipmentManufacturer, 433
- SimpleMemberCommand
  - gdcm::SimpleMemberCommand< T >, 994
- SimpleSubjectWatcher
  - gdcm::SimpleSubjectWatcher, 998
- SimplifiedAdultEchoSRStorage
  - gdcm::UIDs, 1174
- SINGLEBIT
  - gdcm::PixelFormat, 812
- SingleSerieUIDFileSetHT
  - gdcm::SerieHelper, 979
- SingleSerieUIDFileSetmap
  - gdcm::SerieHelper, 975
- Size
  - gdcm::CodeString, 256
  - gdcm::DataSet, 339
  - gdcm::GroupDict, 516
  - gdcm::network::AAabortPDU, 89
  - gdcm::network::AAssociateACPDU, 93
  - gdcm::network::AAssociateRJPDU, 96
  - gdcm::network::AAssociateRQPDU, 102
  - gdcm::network::AbstractSyntax, 106
  - gdcm::network::ApplicationContext, 120
  - gdcm::network::AReleaseRPPDU, 126
  - gdcm::network::AReleaseRQPDU, 128
  - gdcm::network::AsynchronousOperationsWindowSub, 133
  - gdcm::network::BasePDU, 177
  - gdcm::network::ImplementationClassUIDSub, 590
  - gdcm::network::ImplementationVersionNameSub, 592
  - gdcm::network::MaximumLengthSub, 674
  - gdcm::network::PDataTFPDU, 787
  - gdcm::network::PresentationContextAC, 851
  - gdcm::network::PresentationContextRQ, 859
  - gdcm::network::PresentationDataValue, 863
  - gdcm::network::RoleSelectionSub, 926
  - gdcm::network::ServiceClassApplicationInformation, 981
  - gdcm::network::SOPClassExtendedNegotiationSub, 1008
  - gdcm::network::TransferSyntaxSub, 1140
  - gdcm::network::UserInformation, 1266
- size\_type
  - gdcm::CodeString, 254
  - gdcm::LO, 656
  - gdcm::String< TDelimiter, TMaxLength, TPadChar >, 1048
- SizeType
  - gdcm::DataSet, 330
  - gdcm::FilenameGenerator, 488
  - gdcm::IOD, 598
  - gdcm::NestedModuleEntries, 733
  - gdcm::network::AAssociateACPDU, 91
  - gdcm::network::AAssociateRQPDU, 99
  - gdcm::network::PDataTFPDU, 786
  - gdcm::network::PresentationContextRQ, 856
  - gdcm::PresentationContext, 846
  - gdcm::PresentationContextGenerator, 853
  - gdcm::SequenceOfFragments, 959
  - gdcm::SequenceOfItems, 967
- SL
  - gdcm::VR, 1289
- Slice
  - vtkImageColorViewer, 1381
- SLICE\_ORIENTATION\_XY
  - vtkImageColorViewer, 1370
- SLICE\_ORIENTATION\_XZ
  - vtkImageColorViewer, 1370
- SLICE\_ORIENTATION\_YZ
  - vtkImageColorViewer, 1370
- SliceOrientation
  - vtkImageColorViewer, 1381
- Slices
  - gdcm::MrProtocol::SliceArray, 1002
- SmartPointer
  - gdcm::Object, 753
  - gdcm::SmartPointer< ObjectType >, 1004, 1005
- SOPClassExtendedNegotiationSub
  - gdcm::network::SOPClassExtendedNegotiationSub, 1008
- SOPClassUIDMode
  - gdcm::EmptyMaskGenerator, 425
- SOPInstanceUID
  - vtkRTStructSetProperties, 1413
- Sort
  - gdcm::IPPSorter, 609
  - gdcm::Sorter, 1014
- Sorter
  - gdcm::Sorter, 1013
- SortFunc
  - gdcm::Sorter, 1016
- SortFunction
  - gdcm::Sorter, 1013
- SpacialFiducialsStorage
  - gdcm::MediaStorage, 680
- SpacialRegistrationStorage
  - gdcm::MediaStorage, 680
- Spacing
  - gdcm::Spacing, 1018

SpacingType  
     gdcM::Spacing, [1017](#)  
 SpatialFiducialsStorage  
     gdcM::UIDs, [1169](#)  
 SpatialRegistrationStorage  
     gdcM::UIDs, [1169](#)  
 SpectaclePrescriptionReportStorage  
     gdcM::UIDs, [1173](#)  
 Spectroscopy  
     gdcM::Spectroscopy, [1019](#)  
 Split  
     gdcM::ImageFragmentSplitter, [567](#)  
     gdcM::SplitMosaicFilter, [1022](#)  
 SplitExtent  
     vtkGDCMThreadedImageReader2, [1361](#)  
 SplitMosaicFilter  
     gdcM::SplitMosaicFilter, [1020](#)  
 SPM2AVG152PDFrameofReference  
     gdcM::UIDs, [1167](#)  
 SPM2AVG152T1FrameofReference  
     gdcM::UIDs, [1167](#)  
 SPM2AVG152T2FrameofReference  
     gdcM::UIDs, [1167](#)  
 SPM2AVG305T1FrameofReference  
     gdcM::UIDs, [1167](#)  
 SPM2BRAINMASKFrameofReference  
     gdcM::UIDs, [1167](#)  
 SPM2CSFFrameofReference  
     gdcM::UIDs, [1167](#)  
 SPM2EPIFrameofReference  
     gdcM::UIDs, [1167](#)  
 SPM2FILT1FrameofReference  
     gdcM::UIDs, [1167](#)  
 SPM2GRAYFrameofReference  
     gdcM::UIDs, [1167](#)  
 SPM2PDFrameofReference  
     gdcM::UIDs, [1167](#)  
 SPM2PETFrameofReference  
     gdcM::UIDs, [1167](#)  
 SPM2SINGLESUBJT1FrameofReference  
     gdcM::UIDs, [1167](#)  
 SPM2SPECTFrameofReference  
     gdcM::UIDs, [1167](#)  
 SPM2T1FrameofReference  
     gdcM::UIDs, [1167](#)  
 SPM2T2FrameofReference  
     gdcM::UIDs, [1167](#)  
 SPM2TRANSMFrameofReference  
     gdcM::UIDs, [1167](#)  
 SPM2WHITEFrameofReference  
     gdcM::UIDs, [1167](#)  
 SpringColorPaletteSOPInstance  
     gdcM::UIDs, [1172](#)  
 SQ  
     gdcM::VR, [1289](#)  
 Squeeze  
     gdcM::ApplicationEntity, [123](#)  
 SS  
     gdcM::VR, [1289](#)  
 ST  
     gdcM::VR, [1289](#)  
 StableSort  
     gdcM::Sorter, [1015](#)  
 StandaloneCurveStorage  
     gdcM::MediaStorage, [680](#)  
 StandaloneCurveStorageRetired  
     gdcM::UIDs, [1169](#)  
 StandaloneModalityLUTStorage  
     gdcM::MediaStorage, [680](#)  
 StandaloneModalityLUTStorageRetired  
     gdcM::UIDs, [1169](#)  
 StandaloneOverlayStorage  
     gdcM::MediaStorage, [680](#)  
 StandaloneOverlayStorageRetired  
     gdcM::UIDs, [1169](#)  
 StandalonePETCurveStorageRetired  
     gdcM::UIDs, [1170](#)  
 StandaloneVOILUTStorage  
     gdcM::MediaStorage, [680](#)  
 StandaloneVOILUTStorageRetired  
     gdcM::UIDs, [1169](#)  
 Start  
     gdcM::network::ARTIMTimer, [130](#)  
 StartAssociation  
     gdcM::ServiceClassUser, [989](#)  
 StartDataElement  
     gdcM::FileStreamer, [497](#)  
 StartElement  
     gdcM::TableReader, [1103](#)  
     gdcM::XMLDictReader, [1427](#)  
     gdcM::XMLPrivateDictReader, [1433](#)  
 StartElementHandler  
     gdcM::Parser, [780](#)  
 StartEncode  
     gdcM::ImageCodec, [559](#)  
     gdcM::JPEG2000Codec, [628](#)  
     gdcM::JPEGCodec, [640](#)  
     gdcM::JPEGLSCodec, [647](#)  
     gdcM::RLECodec, [924](#)  
 StartFilter  
     gdcM::SimpleSubjectWatcher, [1000](#)  
 StartGroupDataElement  
     gdcM::FileStreamer, [497](#)  
 STATES  
     gdcM::Surface, [1062](#)  
 STATES\_END  
     gdcM::Surface, [1062](#)  
 STComp

- gdcM, 60
- StereometricRelationshipStorage
  - gdcM::UIDs, 1170
- Stop
  - gdcM::network::ARTIMTimer, 130
- StopAssociation
  - gdcM::ServiceClassUser, 989
- StopDataElement
  - gdcM::FileStreamer, 498
- StopEncode
  - gdcM::ImageCodec, 559
  - gdcM::JPEG2000Codec, 628
  - gdcM::JPEGCodec, 640
  - gdcM::JPEGLSCodec, 647
  - gdcM::RLECodec, 924
- StopGroupDataElement
  - gdcM::FileStreamer, 498
- StopProtocol
  - gdcM::network::ULConnection, 1234
- StorageCommitmentPullModelSOPClassRetired
  - gdcM::UIDs, 1167
- StorageCommitmentPullModelSOPInstanceRetired
  - gdcM::UIDs, 1167
- StorageCommitmentPushModelSOPClass
  - gdcM::UIDs, 1167
- StorageCommitmentPushModelSOPInstance
  - gdcM::UIDs, 1167
- StorageServiceClass
  - gdcM::UIDs, 1168
- StoredPrintStorageSOPClassRetired
  - gdcM::UIDs, 1168
- StrCaseCmp
  - gdcM::System, 1094
- Stream
  - gdcM::Writer, 1424
- StreamImageReader
  - gdcM::Reader, 909
  - gdcM::StreamImageReader, 1025
- StreamImageWriter
  - gdcM::StreamImageWriter, 1031
  - gdcM::Writer, 1424
- StrictScanner
  - gdcM::StrictScanner, 1039
- String
  - gdcM::String< TDelimiter, TMaxLength, TPadChar >, 1048, 1049
- StringFilter
  - gdcM::StringFilter, 1051
- StrNCaseCmp
  - gdcM::System, 1095
- StrSep
  - gdcM::System, 1095
- StrTokR
  - gdcM::System, 1095
- StructureSetDate
  - vtkRTStructSetProperties, 1414
- StructureSetLabel
  - vtkRTStructSetProperties, 1414
- StructureSetName
  - vtkRTStructSetProperties, 1414
- StructureSetTime
  - vtkRTStructSetProperties, 1414
- Study
  - gdcM::Study, 1055
- StudyComponentManagementSOPClass
  - gdcM::MediaStorage, 680
- StudyComponentManagementSOPClassRetired
  - gdcM::UIDs, 1167
- StudyInstanceUID
  - vtkRTStructSetProperties, 1414
- StudyRootQueryRetrieveInformationModelFIND
  - gdcM::UIDs, 1170
- StudyRootQueryRetrieveInformationModelGET
  - gdcM::UIDs, 1170
- StudyRootQueryRetrieveInformationModelMOVE
  - gdcM::UIDs, 1170
- Subject
  - gdcM::Subject, 1057
- SubjectiveRefractionMeasurementsStorage
  - gdcM::UIDs, 1173
- SubstanceAdministrationLoggingSOPClass
  - gdcM::UIDs, 1167
- SubstanceAdministrationLoggingSOPInstance
  - gdcM::UIDs, 1167
- SubstanceApprovalQuerySOPClass
  - gdcM::UIDs, 1171
- SummerColorPaletteSOPInstance
  - gdcM::UIDs, 1172
- Superclass
  - gdcM::AnonymizeEvent, 108
  - gdcM::DataEvent, 325
  - gdcM::DataSetEvent, 342
  - gdcM::FileNameEvent, 485
  - gdcM::LO, 656
  - gdcM::ProgressEvent, 876
- SURFACE
  - gdcM::Surface, 1062
- Surface
  - gdcM::Surface, 1062
- SurfaceCount
  - gdcM::Segment, 946
- SurfaceReader
  - gdcM::SurfaceReader, 1079
- Surfaces
  - gdcM::Segment, 946
- SurfaceScanMeshStorage
  - gdcM::UIDs, 1173
- SurfaceScanPointCloudStorage

- gdcM::UIDs, [1173](#)
- SurfaceSegmentationStorage
  - gdcM::MediaStorage, [681](#)
  - gdcM::UIDs, [1172](#)
- SurfaceVector
  - gdcM::Segment, [938](#)
- SurfaceWriter
  - gdcM::SurfaceWriter, [1082](#)
- SV
  - gdcM::VR, [1289](#)
- SV10
  - gdcM::CSAHeader, [288](#)
- Swap
  - gdcM::ByteSwap< T >, [219](#)
  - gdcM::SwapperDoOp, [1086](#)
  - gdcM::SwapperNoOp, [1087](#)
- SwapArray
  - gdcM::SwapperDoOp, [1087](#)
  - gdcM::SwapperNoOp, [1088](#)
- SwapCode
  - gdcM::SwapCode, [1085](#)
- SwapCodeType
  - gdcM::SwapCode, [1085](#)
- SwapFromSwapCodeIntoSystem
  - gdcM::ByteSwap< T >, [220](#)
- SwapRange
  - gdcM::ByteSwap< T >, [220](#)
- SwapRangeFromSwapCodeIntoSystem
  - gdcM::ByteSwap< T >, [220](#)
- SyngoDTField
  - gdcM::CSAElement, [286](#)
- SyntaxError
  - gdcM::Parser, [782](#)
- SystemIsBigEndian
  - gdcM::ByteSwap< T >, [220](#)
- SystemIsLittleEndian
  - gdcM::ByteSwap< T >, [221](#)
- T1
  - gdcM::Type, [1144](#)
- T1C
  - gdcM::Type, [1144](#)
- T2
  - gdcM::Type, [1144](#)
- T2C
  - gdcM::Type, [1144](#)
- T3
  - gdcM::Type, [1144](#)
- Table
  - gdcM::Table, [1097](#)
- Table16
  - vtkLookupTable16, [1402](#)
- TableEntry
  - gdcM::TableEntry, [1099](#)
- TableInternal
  - gdcM::Table, [1098](#)
- TableReader
  - gdcM::TableReader, [1101](#)
- TableRow
  - gdcM::network::TableRow, [1105](#)
- Tag
  - gdcM::Tag, [1107](#), [1108](#)
- tag
  - gdcM::Tag, [1116](#)
- TagField
  - gdcM::DataElement, [321](#)
- TagMismatchError
  - gdcM::Parser, [782](#)
- TagPath
  - gdcM::TagPath, [1117](#)
- tags
  - gdcM::Tag, [1116](#)
- TagsToRead
  - gdcM::Sorter, [1016](#)
- TagToValue
  - gdcM::Scanner, [930](#)
  - gdcM::StrictScanner, [1039](#)
- TagToValueValueType
  - gdcM::Scanner, [930](#)
  - gdcM::StrictScanner, [1039](#)
- TalairachBrainAtlasFrameofReference
  - gdcM::UIDs, [1167](#)
- TConstMemberFunctionPointer
  - gdcM::MemberCommand< T >, [689](#)
- TestAbortOff
  - gdcM::SimpleSubjectWatcher, [1000](#)
- TestAbortOn
  - gdcM::SimpleSubjectWatcher, [1000](#)
- Testing
  - gdcM::Testing, [1120](#)
- TestPBKDF2
  - gdcM::ASN1, [132](#)
- TestsList.txt, [1713](#)
- TextSRStorageTrialRetired
  - gdcM::UIDs, [1170](#)
- ThreadedExecute
  - vtkImageRGBToYBR, [1396](#)
  - vtkImageYBRToRGB, [1398](#)
- ThreadedRequestData
  - vtkGDCMThreadedImageReader2, [1361](#)
  - vtkImageMapToColors16, [1385](#)
  - vtkImageMapToWindowLevelColors2, [1390](#)
- TM
  - gdcM::VR, [1289](#)
- TMComp
  - gdcM, [60](#)
- TMemberFunctionPointer
  - gdcM::MemberCommand< T >, [689](#)

- gdcM::SimpleMemberCommand< T >, 994
- ToPyObject
  - gdcM::PythonFilter, 882
- TOSHIBA
  - gdcM::EquipmentManufacturer, 433
- ToshibaPrivateDataStorage
  - gdcM::MediaStorage, 681
- ToString
  - gdcM::StringFilter, 1053
- ToStringPair
  - gdcM::StringFilter, 1054
- ToUnixSlashes
  - gdcM::Filename, 482
- ToWindowsSlashes
  - gdcM::Filename, 482
- Trace
  - gdcM::Trace, 1128
- TractographyResultsStorage
  - gdcM::UIDs, 1173
- TransferSyntax
  - gdcM::TransferSyntax, 1135
- TransferSyntaxArrayType
  - gdcM::PresentationContext, 846
- TransferSyntaxes
  - gdcM::PresentationContext, 848
- TransferSyntaxStringsType
  - gdcM::UIDs, 1165
- TransferSyntaxSub
  - gdcM::network::TransferSyntaxSub, 1139
- Transition
  - gdcM::network::Transition, 1142
- transitions
  - gdcM::network::TableRow, 1105
- TRIANGLE
  - gdcM::MeshPrimitive, 695
- TRIANGLE\_FAN
  - gdcM::MeshPrimitive, 695
- TRIANGLE\_STRIP
  - gdcM::MeshPrimitive, 695
- Trim
  - gdcM::String< TDelimiter, TMaxLength, TPadChar >, 1049, 1050
- TrimInternal
  - gdcM::CodeString, 256
- Truncate
  - gdcM::String< TDelimiter, TMaxLength, TPadChar >, 1050
- TryJPEG2000Codec
  - gdcM::Bitmap, 205
  - gdcM::ImageChangeTransferSyntax, 547
- TryJPEG2000Codec2
  - gdcM::Bitmap, 206
- TryJPEGCodec
  - gdcM::Bitmap, 206
- gdcM::ImageChangeTransferSyntax, 547
- TryJPEGCodec2
  - gdcM::Bitmap, 206
- TryJPEGLSCoDec
  - gdcM::Bitmap, 206
  - gdcM::ImageChangeTransferSyntax, 547
- TryKAKADUCoDec
  - gdcM::Bitmap, 206
- TryPVRGCoDec
  - gdcM::Bitmap, 206
- TryRAWCoDec
  - gdcM::Bitmap, 207
  - gdcM::ImageChangeTransferSyntax, 548
- TryRLECoDec
  - gdcM::Bitmap, 207
  - gdcM::ImageChangeTransferSyntax, 548
- TS
  - gdcM::Bitmap, 209
- TS\_END
  - gdcM::TransferSyntax, 1135
- TSName
  - gdcM::UIDs, 1166
- TSType
  - gdcM::TransferSyntax, 1135
  - gdcM::UIDs, 1175
- Type
  - gdcM::Element< TVR, TVM >, 397
  - gdcM::Element< TVR, VM::VM1\_n >, 404
  - gdcM::EquipmentManufacturer, 433
  - gdcM::Type, 1144
  - gdcM::VL, 1278
- TYPETOENCODING
  - gdcM, 75
  - gdcMVR.h, 1707
- TYPETOLENGTH
  - gdcMVM.h, 1705
- TypeType
  - gdcM::Type, 1144
- UberonOntology
  - gdcM::UIDs, 1172
- UC
  - gdcM::VR, 1289
- UCComp
  - gdcM, 60
- UI
  - gdcM::VR, 1289
- UIComp
  - gdcM, 60
- uid\_1\_2\_840\_10008\_15\_0\_3\_1
  - gdcM::UIDs, 1180
- uid\_1\_2\_840\_10008\_15\_0\_3\_10
  - gdcM::UIDs, 1181
- uid\_1\_2\_840\_10008\_15\_0\_3\_11



gdcn::UIDs, [1181](#)  
uid\_1\_2\_840\_10008\_15\_0\_3\_12  
gdcn::UIDs, [1181](#)  
uid\_1\_2\_840\_10008\_15\_0\_3\_13  
gdcn::UIDs, [1181](#)  
uid\_1\_2\_840\_10008\_15\_0\_3\_14  
gdcn::UIDs, [1181](#)  
uid\_1\_2\_840\_10008\_15\_0\_3\_15  
gdcn::UIDs, [1181](#)  
uid\_1\_2\_840\_10008\_15\_0\_3\_16  
gdcn::UIDs, [1181](#)  
uid\_1\_2\_840\_10008\_15\_0\_3\_17  
gdcn::UIDs, [1181](#)  
uid\_1\_2\_840\_10008\_15\_0\_3\_18  
gdcn::UIDs, [1181](#)  
uid\_1\_2\_840\_10008\_15\_0\_3\_19  
gdcn::UIDs, [1181](#)  
uid\_1\_2\_840\_10008\_15\_0\_3\_2  
gdcn::UIDs, [1180](#)  
uid\_1\_2\_840\_10008\_15\_0\_3\_20  
gdcn::UIDs, [1181](#)  
uid\_1\_2\_840\_10008\_15\_0\_3\_21  
gdcn::UIDs, [1181](#)  
uid\_1\_2\_840\_10008\_15\_0\_3\_22  
gdcn::UIDs, [1181](#)  
uid\_1\_2\_840\_10008\_15\_0\_3\_23  
gdcn::UIDs, [1181](#)  
uid\_1\_2\_840\_10008\_15\_0\_3\_24  
gdcn::UIDs, [1181](#)  
uid\_1\_2\_840\_10008\_15\_0\_3\_25  
gdcn::UIDs, [1181](#)  
uid\_1\_2\_840\_10008\_15\_0\_3\_26  
gdcn::UIDs, [1181](#)  
uid\_1\_2\_840\_10008\_15\_0\_3\_27  
gdcn::UIDs, [1181](#)  
uid\_1\_2\_840\_10008\_15\_0\_3\_28  
gdcn::UIDs, [1181](#)  
uid\_1\_2\_840\_10008\_15\_0\_3\_29  
gdcn::UIDs, [1181](#)  
uid\_1\_2\_840\_10008\_15\_0\_3\_3  
gdcn::UIDs, [1181](#)  
uid\_1\_2\_840\_10008\_15\_0\_3\_30  
gdcn::UIDs, [1181](#)  
uid\_1\_2\_840\_10008\_15\_0\_3\_31  
gdcn::UIDs, [1181](#)  
uid\_1\_2\_840\_10008\_15\_0\_3\_4  
gdcn::UIDs, [1181](#)  
uid\_1\_2\_840\_10008\_15\_0\_3\_5  
gdcn::UIDs, [1181](#)  
uid\_1\_2\_840\_10008\_15\_0\_3\_6  
gdcn::UIDs, [1181](#)  
uid\_1\_2\_840\_10008\_15\_0\_3\_7  
gdcn::UIDs, [1181](#)  
uid\_1\_2\_840\_10008\_15\_0\_3\_8  
gdcn::UIDs, [1181](#)  
uid\_1\_2\_840\_10008\_15\_0\_3\_9  
gdcn::UIDs, [1181](#)  
uid\_1\_2\_840\_10008\_15\_0\_4\_1  
gdcn::UIDs, [1181](#)  
uid\_1\_2\_840\_10008\_15\_0\_4\_2  
gdcn::UIDs, [1181](#)  
uid\_1\_2\_840\_10008\_15\_0\_4\_3  
gdcn::UIDs, [1181](#)  
uid\_1\_2\_840\_10008\_15\_0\_4\_4  
gdcn::UIDs, [1181](#)  
uid\_1\_2\_840\_10008\_15\_0\_4\_5  
gdcn::UIDs, [1181](#)  
uid\_1\_2\_840\_10008\_15\_0\_4\_6  
gdcn::UIDs, [1181](#)  
uid\_1\_2\_840\_10008\_15\_0\_4\_7  
gdcn::UIDs, [1181](#)  
uid\_1\_2\_840\_10008\_15\_0\_4\_8  
gdcn::UIDs, [1181](#)  
uid\_1\_2\_840\_10008\_15\_1\_1  
gdcn::UIDs, [1184](#)  
uid\_1\_2\_840\_10008\_1\_1  
gdcn::UIDs, [1175](#)  
uid\_1\_2\_840\_10008\_1\_2  
gdcn::UIDs, [1175](#)  
uid\_1\_2\_840\_10008\_1\_20  
gdcn::UIDs, [1182](#)  
uid\_1\_2\_840\_10008\_1\_20\_1  
gdcn::UIDs, [1177](#)  
uid\_1\_2\_840\_10008\_1\_20\_1\_1  
gdcn::UIDs, [1177](#)  
uid\_1\_2\_840\_10008\_1\_20\_2  
gdcn::UIDs, [1177](#)  
uid\_1\_2\_840\_10008\_1\_20\_2\_1  
gdcn::UIDs, [1177](#)  
uid\_1\_2\_840\_10008\_1\_2\_1  
gdcn::UIDs, [1175](#)  
uid\_1\_2\_840\_10008\_1\_2\_1\_99  
gdcn::UIDs, [1175](#)  
uid\_1\_2\_840\_10008\_1\_2\_2  
gdcn::UIDs, [1175](#)  
uid\_1\_2\_840\_10008\_1\_2\_4\_100  
gdcn::UIDs, [1176](#)  
uid\_1\_2\_840\_10008\_1\_2\_4\_101  
gdcn::UIDs, [1181](#)  
uid\_1\_2\_840\_10008\_1\_2\_4\_102  
gdcn::UIDs, [1181](#)  
uid\_1\_2\_840\_10008\_1\_2\_4\_103  
gdcn::UIDs, [1182](#)  
uid\_1\_2\_840\_10008\_1\_2\_4\_104  
gdcn::UIDs, [1182](#)  
uid\_1\_2\_840\_10008\_1\_2\_4\_105  
gdcn::UIDs, [1182](#)  
uid\_1\_2\_840\_10008\_1\_2\_4\_106



gdcM::UIDs, [1182](#)  
uid\_1\_2\_840\_10008\_1\_2\_4\_107  
gdcM::UIDs, [1182](#)  
uid\_1\_2\_840\_10008\_1\_2\_4\_108  
gdcM::UIDs, [1182](#)  
uid\_1\_2\_840\_10008\_1\_2\_4\_50  
gdcM::UIDs, [1175](#)  
uid\_1\_2\_840\_10008\_1\_2\_4\_51  
gdcM::UIDs, [1175](#)  
uid\_1\_2\_840\_10008\_1\_2\_4\_52  
gdcM::UIDs, [1176](#)  
uid\_1\_2\_840\_10008\_1\_2\_4\_53  
gdcM::UIDs, [1176](#)  
uid\_1\_2\_840\_10008\_1\_2\_4\_54  
gdcM::UIDs, [1176](#)  
uid\_1\_2\_840\_10008\_1\_2\_4\_55  
gdcM::UIDs, [1176](#)  
uid\_1\_2\_840\_10008\_1\_2\_4\_56  
gdcM::UIDs, [1176](#)  
uid\_1\_2\_840\_10008\_1\_2\_4\_57  
gdcM::UIDs, [1176](#)  
uid\_1\_2\_840\_10008\_1\_2\_4\_58  
gdcM::UIDs, [1176](#)  
uid\_1\_2\_840\_10008\_1\_2\_4\_59  
gdcM::UIDs, [1176](#)  
uid\_1\_2\_840\_10008\_1\_2\_4\_60  
gdcM::UIDs, [1176](#)  
uid\_1\_2\_840\_10008\_1\_2\_4\_61  
gdcM::UIDs, [1176](#)  
uid\_1\_2\_840\_10008\_1\_2\_4\_62  
gdcM::UIDs, [1176](#)  
uid\_1\_2\_840\_10008\_1\_2\_4\_63  
gdcM::UIDs, [1176](#)  
uid\_1\_2\_840\_10008\_1\_2\_4\_64  
gdcM::UIDs, [1176](#)  
uid\_1\_2\_840\_10008\_1\_2\_4\_65  
gdcM::UIDs, [1176](#)  
uid\_1\_2\_840\_10008\_1\_2\_4\_66  
gdcM::UIDs, [1176](#)  
uid\_1\_2\_840\_10008\_1\_2\_4\_70  
gdcM::UIDs, [1176](#)  
uid\_1\_2\_840\_10008\_1\_2\_4\_80  
gdcM::UIDs, [1176](#)  
uid\_1\_2\_840\_10008\_1\_2\_4\_81  
gdcM::UIDs, [1176](#)  
uid\_1\_2\_840\_10008\_1\_2\_4\_90  
gdcM::UIDs, [1176](#)  
uid\_1\_2\_840\_10008\_1\_2\_4\_91  
gdcM::UIDs, [1176](#)  
uid\_1\_2\_840\_10008\_1\_2\_4\_92  
gdcM::UIDs, [1176](#)  
uid\_1\_2\_840\_10008\_1\_2\_4\_93  
gdcM::UIDs, [1176](#)  
uid\_1\_2\_840\_10008\_1\_2\_4\_94  
gdcM::UIDs, [1176](#)  
uid\_1\_2\_840\_10008\_1\_2\_4\_95  
gdcM::UIDs, [1176](#)  
uid\_1\_2\_840\_10008\_1\_2\_5  
gdcM::UIDs, [1176](#)  
uid\_1\_2\_840\_10008\_1\_2\_6\_1  
gdcM::UIDs, [1176](#)  
uid\_1\_2\_840\_10008\_1\_2\_6\_2  
gdcM::UIDs, [1176](#)  
uid\_1\_2\_840\_10008\_1\_3\_10  
gdcM::UIDs, [1176](#)  
uid\_1\_2\_840\_10008\_1\_40  
gdcM::UIDs, [1177](#)  
uid\_1\_2\_840\_10008\_1\_40\_1  
gdcM::UIDs, [1177](#)  
uid\_1\_2\_840\_10008\_1\_42  
gdcM::UIDs, [1177](#)  
uid\_1\_2\_840\_10008\_1\_42\_1  
gdcM::UIDs, [1177](#)  
uid\_1\_2\_840\_10008\_1\_4\_1\_1  
gdcM::UIDs, [1176](#)  
uid\_1\_2\_840\_10008\_1\_4\_1\_10  
gdcM::UIDs, [1176](#)  
uid\_1\_2\_840\_10008\_1\_4\_1\_11  
gdcM::UIDs, [1176](#)  
uid\_1\_2\_840\_10008\_1\_4\_1\_12  
gdcM::UIDs, [1176](#)  
uid\_1\_2\_840\_10008\_1\_4\_1\_13  
gdcM::UIDs, [1176](#)  
uid\_1\_2\_840\_10008\_1\_4\_1\_14  
gdcM::UIDs, [1176](#)  
uid\_1\_2\_840\_10008\_1\_4\_1\_15  
gdcM::UIDs, [1176](#)  
uid\_1\_2\_840\_10008\_1\_4\_1\_16  
gdcM::UIDs, [1176](#)  
uid\_1\_2\_840\_10008\_1\_4\_1\_17  
gdcM::UIDs, [1176](#)  
uid\_1\_2\_840\_10008\_1\_4\_1\_18  
gdcM::UIDs, [1177](#)  
uid\_1\_2\_840\_10008\_1\_4\_1\_2  
gdcM::UIDs, [1176](#)  
uid\_1\_2\_840\_10008\_1\_4\_1\_3  
gdcM::UIDs, [1176](#)  
uid\_1\_2\_840\_10008\_1\_4\_1\_4  
gdcM::UIDs, [1176](#)  
uid\_1\_2\_840\_10008\_1\_4\_1\_5  
gdcM::UIDs, [1176](#)  
uid\_1\_2\_840\_10008\_1\_4\_1\_6  
gdcM::UIDs, [1176](#)  
uid\_1\_2\_840\_10008\_1\_4\_1\_7  
gdcM::UIDs, [1176](#)  
uid\_1\_2\_840\_10008\_1\_4\_1\_8  
gdcM::UIDs, [1176](#)  
uid\_1\_2\_840\_10008\_1\_4\_1\_9

gdcM::UIDs, [1176](#)  
uid\_1\_2\_840\_10008\_1\_4\_2\_1  
gdcM::UIDs, [1177](#)  
uid\_1\_2\_840\_10008\_1\_4\_2\_2  
gdcM::UIDs, [1177](#)  
uid\_1\_2\_840\_10008\_1\_5\_1  
gdcM::UIDs, [1182](#)  
uid\_1\_2\_840\_10008\_1\_5\_2  
gdcM::UIDs, [1182](#)  
uid\_1\_2\_840\_10008\_1\_5\_3  
gdcM::UIDs, [1182](#)  
uid\_1\_2\_840\_10008\_1\_5\_4  
gdcM::UIDs, [1182](#)  
uid\_1\_2\_840\_10008\_1\_5\_5  
gdcM::UIDs, [1182](#)  
uid\_1\_2\_840\_10008\_1\_5\_6  
gdcM::UIDs, [1182](#)  
uid\_1\_2\_840\_10008\_1\_5\_7  
gdcM::UIDs, [1182](#)  
uid\_1\_2\_840\_10008\_1\_5\_8  
gdcM::UIDs, [1182](#)  
uid\_1\_2\_840\_10008\_1\_9  
gdcM::UIDs, [1177](#)  
uid\_1\_2\_840\_10008\_2\_16\_10  
gdcM::UIDs, [1182](#)  
uid\_1\_2\_840\_10008\_2\_16\_11  
gdcM::UIDs, [1182](#)  
uid\_1\_2\_840\_10008\_2\_16\_12  
gdcM::UIDs, [1182](#)  
uid\_1\_2\_840\_10008\_2\_16\_13  
gdcM::UIDs, [1182](#)  
uid\_1\_2\_840\_10008\_2\_16\_14  
gdcM::UIDs, [1182](#)  
uid\_1\_2\_840\_10008\_2\_16\_4  
gdcM::UIDs, [1177](#)  
uid\_1\_2\_840\_10008\_2\_16\_5  
gdcM::UIDs, [1182](#)  
uid\_1\_2\_840\_10008\_2\_16\_6  
gdcM::UIDs, [1182](#)  
uid\_1\_2\_840\_10008\_2\_16\_7  
gdcM::UIDs, [1182](#)  
uid\_1\_2\_840\_10008\_2\_16\_8  
gdcM::UIDs, [1182](#)  
uid\_1\_2\_840\_10008\_2\_16\_9  
gdcM::UIDs, [1182](#)  
uid\_1\_2\_840\_10008\_2\_6\_1  
gdcM::UIDs, [1177](#)  
uid\_1\_2\_840\_10008\_3\_1\_1\_1  
gdcM::UIDs, [1177](#)  
uid\_1\_2\_840\_10008\_3\_1\_2\_1\_1  
gdcM::UIDs, [1177](#)  
uid\_1\_2\_840\_10008\_3\_1\_2\_1\_4  
gdcM::UIDs, [1177](#)  
uid\_1\_2\_840\_10008\_3\_1\_2\_2\_1  
gdcM::UIDs, [1177](#)  
uid\_1\_2\_840\_10008\_3\_1\_2\_3\_1  
gdcM::UIDs, [1177](#)  
uid\_1\_2\_840\_10008\_3\_1\_2\_3\_2  
gdcM::UIDs, [1177](#)  
uid\_1\_2\_840\_10008\_3\_1\_2\_3\_3  
gdcM::UIDs, [1177](#)  
uid\_1\_2\_840\_10008\_3\_1\_2\_3\_4  
gdcM::UIDs, [1177](#)  
uid\_1\_2\_840\_10008\_3\_1\_2\_3\_5  
gdcM::UIDs, [1177](#)  
uid\_1\_2\_840\_10008\_3\_1\_2\_5\_1  
gdcM::UIDs, [1177](#)  
uid\_1\_2\_840\_10008\_3\_1\_2\_5\_4  
gdcM::UIDs, [1177](#)  
uid\_1\_2\_840\_10008\_3\_1\_2\_5\_5  
gdcM::UIDs, [1177](#)  
uid\_1\_2\_840\_10008\_3\_1\_2\_6\_1  
gdcM::UIDs, [1177](#)  
uid\_1\_2\_840\_10008\_4\_2  
gdcM::UIDs, [1177](#)  
uid\_1\_2\_840\_10008\_5\_1\_1\_1  
gdcM::UIDs, [1177](#)  
uid\_1\_2\_840\_10008\_5\_1\_1\_14  
gdcM::UIDs, [1177](#)  
uid\_1\_2\_840\_10008\_5\_1\_1\_15  
gdcM::UIDs, [1177](#)  
uid\_1\_2\_840\_10008\_5\_1\_1\_16  
gdcM::UIDs, [1177](#)  
uid\_1\_2\_840\_10008\_5\_1\_1\_16\_376  
gdcM::UIDs, [1177](#)  
uid\_1\_2\_840\_10008\_5\_1\_1\_17  
gdcM::UIDs, [1177](#)  
uid\_1\_2\_840\_10008\_5\_1\_1\_17\_376  
gdcM::UIDs, [1177](#)  
uid\_1\_2\_840\_10008\_5\_1\_1\_18  
gdcM::UIDs, [1177](#)  
uid\_1\_2\_840\_10008\_5\_1\_1\_18\_1  
gdcM::UIDs, [1177](#)  
uid\_1\_2\_840\_10008\_5\_1\_1\_2  
gdcM::UIDs, [1177](#)  
uid\_1\_2\_840\_10008\_5\_1\_1\_22  
gdcM::UIDs, [1177](#)  
uid\_1\_2\_840\_10008\_5\_1\_1\_23  
gdcM::UIDs, [1177](#)  
uid\_1\_2\_840\_10008\_5\_1\_1\_24  
gdcM::UIDs, [1177](#)  
uid\_1\_2\_840\_10008\_5\_1\_1\_24\_1  
gdcM::UIDs, [1178](#)  
uid\_1\_2\_840\_10008\_5\_1\_1\_25  
gdcM::UIDs, [1178](#)  
uid\_1\_2\_840\_10008\_5\_1\_1\_26  
gdcM::UIDs, [1178](#)  
uid\_1\_2\_840\_10008\_5\_1\_1\_27

gdcM::UIDs, 1178  
uid\_1\_2\_840\_10008\_5\_1\_1\_29  
gdcM::UIDs, 1178  
uid\_1\_2\_840\_10008\_5\_1\_1\_30  
gdcM::UIDs, 1178  
uid\_1\_2\_840\_10008\_5\_1\_1\_31  
gdcM::UIDs, 1178  
uid\_1\_2\_840\_10008\_5\_1\_1\_32  
gdcM::UIDs, 1178  
uid\_1\_2\_840\_10008\_5\_1\_1\_33  
gdcM::UIDs, 1178  
uid\_1\_2\_840\_10008\_5\_1\_1\_4  
gdcM::UIDs, 1177  
uid\_1\_2\_840\_10008\_5\_1\_1\_40  
gdcM::UIDs, 1182  
uid\_1\_2\_840\_10008\_5\_1\_1\_40\_1  
gdcM::UIDs, 1182  
uid\_1\_2\_840\_10008\_5\_1\_1\_4\_1  
gdcM::UIDs, 1177  
uid\_1\_2\_840\_10008\_5\_1\_1\_4\_2  
gdcM::UIDs, 1177  
uid\_1\_2\_840\_10008\_5\_1\_1\_9  
gdcM::UIDs, 1177  
uid\_1\_2\_840\_10008\_5\_1\_1\_9\_1  
gdcM::UIDs, 1177  
uid\_1\_2\_840\_10008\_5\_1\_4\_1\_1\_1  
gdcM::UIDs, 1178  
uid\_1\_2\_840\_10008\_5\_1\_4\_1\_1\_10  
gdcM::UIDs, 1178  
uid\_1\_2\_840\_10008\_5\_1\_4\_1\_1\_104\_1  
gdcM::UIDs, 1179  
uid\_1\_2\_840\_10008\_5\_1\_4\_1\_1\_104\_2  
gdcM::UIDs, 1180  
uid\_1\_2\_840\_10008\_5\_1\_4\_1\_1\_104\_3  
gdcM::UIDs, 1183  
uid\_1\_2\_840\_10008\_5\_1\_4\_1\_1\_11  
gdcM::UIDs, 1178  
uid\_1\_2\_840\_10008\_5\_1\_4\_1\_1\_11\_1  
gdcM::UIDs, 1178  
uid\_1\_2\_840\_10008\_5\_1\_4\_1\_1\_11\_10  
gdcM::UIDs, 1182  
uid\_1\_2\_840\_10008\_5\_1\_4\_1\_1\_11\_11  
gdcM::UIDs, 1182  
uid\_1\_2\_840\_10008\_5\_1\_4\_1\_1\_11\_2  
gdcM::UIDs, 1178  
uid\_1\_2\_840\_10008\_5\_1\_4\_1\_1\_11\_3  
gdcM::UIDs, 1178  
uid\_1\_2\_840\_10008\_5\_1\_4\_1\_1\_11\_4  
gdcM::UIDs, 1178  
uid\_1\_2\_840\_10008\_5\_1\_4\_1\_1\_11\_5  
gdcM::UIDs, 1182  
uid\_1\_2\_840\_10008\_5\_1\_4\_1\_1\_11\_6  
gdcM::UIDs, 1182  
uid\_1\_2\_840\_10008\_5\_1\_4\_1\_1\_11\_7  
gdcM::UIDs, 1182  
uid\_1\_2\_840\_10008\_5\_1\_4\_1\_1\_11\_8  
gdcM::UIDs, 1182  
uid\_1\_2\_840\_10008\_5\_1\_4\_1\_1\_11\_9  
gdcM::UIDs, 1182  
uid\_1\_2\_840\_10008\_5\_1\_4\_1\_1\_128  
gdcM::UIDs, 1180  
uid\_1\_2\_840\_10008\_5\_1\_4\_1\_1\_128\_1  
gdcM::UIDs, 1181  
uid\_1\_2\_840\_10008\_5\_1\_4\_1\_1\_129  
gdcM::UIDs, 1180  
uid\_1\_2\_840\_10008\_5\_1\_4\_1\_1\_12\_1  
gdcM::UIDs, 1179  
uid\_1\_2\_840\_10008\_5\_1\_4\_1\_1\_12\_1\_1  
gdcM::UIDs, 1179  
uid\_1\_2\_840\_10008\_5\_1\_4\_1\_1\_12\_2  
gdcM::UIDs, 1179  
uid\_1\_2\_840\_10008\_5\_1\_4\_1\_1\_12\_2\_1  
gdcM::UIDs, 1179  
uid\_1\_2\_840\_10008\_5\_1\_4\_1\_1\_12\_3  
gdcM::UIDs, 1179  
uid\_1\_2\_840\_10008\_5\_1\_4\_1\_1\_12\_77  
gdcM::UIDs, 1182  
uid\_1\_2\_840\_10008\_5\_1\_4\_1\_1\_130  
gdcM::UIDs, 1183  
uid\_1\_2\_840\_10008\_5\_1\_4\_1\_1\_131  
gdcM::UIDs, 1183  
uid\_1\_2\_840\_10008\_5\_1\_4\_1\_1\_13\_1\_1  
gdcM::UIDs, 1179  
uid\_1\_2\_840\_10008\_5\_1\_4\_1\_1\_13\_1\_2  
gdcM::UIDs, 1179  
uid\_1\_2\_840\_10008\_5\_1\_4\_1\_1\_13\_1\_3  
gdcM::UIDs, 1181  
uid\_1\_2\_840\_10008\_5\_1\_4\_1\_1\_13\_1\_4  
gdcM::UIDs, 1182  
uid\_1\_2\_840\_10008\_5\_1\_4\_1\_1\_13\_1\_5  
gdcM::UIDs, 1182  
uid\_1\_2\_840\_10008\_5\_1\_4\_1\_1\_14\_1  
gdcM::UIDs, 1182  
uid\_1\_2\_840\_10008\_5\_1\_4\_1\_1\_14\_2  
gdcM::UIDs, 1182  
uid\_1\_2\_840\_10008\_5\_1\_4\_1\_1\_1\_1  
gdcM::UIDs, 1178  
uid\_1\_2\_840\_10008\_5\_1\_4\_1\_1\_1\_1\_1  
gdcM::UIDs, 1178  
uid\_1\_2\_840\_10008\_5\_1\_4\_1\_1\_1\_2  
gdcM::UIDs, 1178  
uid\_1\_2\_840\_10008\_5\_1\_4\_1\_1\_1\_2\_1  
gdcM::UIDs, 1178  
uid\_1\_2\_840\_10008\_5\_1\_4\_1\_1\_1\_3  
gdcM::UIDs, 1178  
uid\_1\_2\_840\_10008\_5\_1\_4\_1\_1\_1\_3\_1  
gdcM::UIDs, 1178  
uid\_1\_2\_840\_10008\_5\_1\_4\_1\_1\_2

gdcM::UIDs, 1178  
uid\_1\_2\_840\_10008\_5\_1\_4\_1\_1\_20  
gdcM::UIDs, 1179  
uid\_1\_2\_840\_10008\_5\_1\_4\_1\_1\_200\_1  
gdcM::UIDs, 1183  
uid\_1\_2\_840\_10008\_5\_1\_4\_1\_1\_200\_2  
gdcM::UIDs, 1183  
uid\_1\_2\_840\_10008\_5\_1\_4\_1\_1\_200\_3  
gdcM::UIDs, 1183  
uid\_1\_2\_840\_10008\_5\_1\_4\_1\_1\_200\_4  
gdcM::UIDs, 1183  
uid\_1\_2\_840\_10008\_5\_1\_4\_1\_1\_200\_5  
gdcM::UIDs, 1183  
uid\_1\_2\_840\_10008\_5\_1\_4\_1\_1\_200\_6  
gdcM::UIDs, 1183  
uid\_1\_2\_840\_10008\_5\_1\_4\_1\_1\_2\_1  
gdcM::UIDs, 1178  
uid\_1\_2\_840\_10008\_5\_1\_4\_1\_1\_2\_2  
gdcM::UIDs, 1181  
uid\_1\_2\_840\_10008\_5\_1\_4\_1\_1\_3  
gdcM::UIDs, 1178  
uid\_1\_2\_840\_10008\_5\_1\_4\_1\_1\_30  
gdcM::UIDs, 1182  
uid\_1\_2\_840\_10008\_5\_1\_4\_1\_1\_3\_1  
gdcM::UIDs, 1178  
uid\_1\_2\_840\_10008\_5\_1\_4\_1\_1\_4  
gdcM::UIDs, 1178  
uid\_1\_2\_840\_10008\_5\_1\_4\_1\_1\_40  
gdcM::UIDs, 1182  
uid\_1\_2\_840\_10008\_5\_1\_4\_1\_1\_481\_1  
gdcM::UIDs, 1180  
uid\_1\_2\_840\_10008\_5\_1\_4\_1\_1\_481\_10  
gdcM::UIDs, 1183  
uid\_1\_2\_840\_10008\_5\_1\_4\_1\_1\_481\_11  
gdcM::UIDs, 1183  
uid\_1\_2\_840\_10008\_5\_1\_4\_1\_1\_481\_2  
gdcM::UIDs, 1180  
uid\_1\_2\_840\_10008\_5\_1\_4\_1\_1\_481\_3  
gdcM::UIDs, 1180  
uid\_1\_2\_840\_10008\_5\_1\_4\_1\_1\_481\_4  
gdcM::UIDs, 1180  
uid\_1\_2\_840\_10008\_5\_1\_4\_1\_1\_481\_5  
gdcM::UIDs, 1180  
uid\_1\_2\_840\_10008\_5\_1\_4\_1\_1\_481\_6  
gdcM::UIDs, 1180  
uid\_1\_2\_840\_10008\_5\_1\_4\_1\_1\_481\_7  
gdcM::UIDs, 1180  
uid\_1\_2\_840\_10008\_5\_1\_4\_1\_1\_481\_8  
gdcM::UIDs, 1180  
uid\_1\_2\_840\_10008\_5\_1\_4\_1\_1\_481\_9  
gdcM::UIDs, 1180  
uid\_1\_2\_840\_10008\_5\_1\_4\_1\_1\_4\_1  
gdcM::UIDs, 1178  
uid\_1\_2\_840\_10008\_5\_1\_4\_1\_1\_4\_2

gdcM::UIDs, 1178  
uid\_1\_2\_840\_10008\_5\_1\_4\_1\_1\_4\_3  
gdcM::UIDs, 1184  
uid\_1\_2\_840\_10008\_5\_1\_4\_1\_1\_4\_4  
gdcM::UIDs, 1181  
uid\_1\_2\_840\_10008\_5\_1\_4\_1\_1\_5  
gdcM::UIDs, 1178  
uid\_1\_2\_840\_10008\_5\_1\_4\_1\_1\_501\_1  
gdcM::UIDs, 1183  
uid\_1\_2\_840\_10008\_5\_1\_4\_1\_1\_501\_2\_1  
gdcM::UIDs, 1183  
uid\_1\_2\_840\_10008\_5\_1\_4\_1\_1\_501\_2\_2  
gdcM::UIDs, 1183  
uid\_1\_2\_840\_10008\_5\_1\_4\_1\_1\_501\_3  
gdcM::UIDs, 1183  
uid\_1\_2\_840\_10008\_5\_1\_4\_1\_1\_501\_4  
gdcM::UIDs, 1184  
uid\_1\_2\_840\_10008\_5\_1\_4\_1\_1\_501\_5  
gdcM::UIDs, 1184  
uid\_1\_2\_840\_10008\_5\_1\_4\_1\_1\_501\_6  
gdcM::UIDs, 1184  
uid\_1\_2\_840\_10008\_5\_1\_4\_1\_1\_6  
gdcM::UIDs, 1178  
uid\_1\_2\_840\_10008\_5\_1\_4\_1\_1\_601\_1  
gdcM::UIDs, 1184  
uid\_1\_2\_840\_10008\_5\_1\_4\_1\_1\_601\_2  
gdcM::UIDs, 1184  
uid\_1\_2\_840\_10008\_5\_1\_4\_1\_1\_66  
gdcM::UIDs, 1179  
uid\_1\_2\_840\_10008\_5\_1\_4\_1\_1\_66\_1  
gdcM::UIDs, 1179  
uid\_1\_2\_840\_10008\_5\_1\_4\_1\_1\_66\_2  
gdcM::UIDs, 1179  
uid\_1\_2\_840\_10008\_5\_1\_4\_1\_1\_66\_3  
gdcM::UIDs, 1179  
uid\_1\_2\_840\_10008\_5\_1\_4\_1\_1\_66\_4  
gdcM::UIDs, 1179  
uid\_1\_2\_840\_10008\_5\_1\_4\_1\_1\_66\_5  
gdcM::UIDs, 1181  
uid\_1\_2\_840\_10008\_5\_1\_4\_1\_1\_66\_6  
gdcM::UIDs, 1182  
uid\_1\_2\_840\_10008\_5\_1\_4\_1\_1\_67  
gdcM::UIDs, 1179  
uid\_1\_2\_840\_10008\_5\_1\_4\_1\_1\_68\_1  
gdcM::UIDs, 1182  
uid\_1\_2\_840\_10008\_5\_1\_4\_1\_1\_68\_2  
gdcM::UIDs, 1183  
uid\_1\_2\_840\_10008\_5\_1\_4\_1\_1\_6\_1  
gdcM::UIDs, 1178  
uid\_1\_2\_840\_10008\_5\_1\_4\_1\_1\_6\_2  
gdcM::UIDs, 1181  
uid\_1\_2\_840\_10008\_5\_1\_4\_1\_1\_7  
gdcM::UIDs, 1178  
uid\_1\_2\_840\_10008\_5\_1\_4\_1\_1\_77\_1

gdcM::UIDs, 1179  
uid\_1\_2\_840\_10008\_5\_1\_4\_1\_1\_77\_1\_1  
gdcM::UIDs, 1179  
uid\_1\_2\_840\_10008\_5\_1\_4\_1\_1\_77\_1\_1\_1  
gdcM::UIDs, 1179  
uid\_1\_2\_840\_10008\_5\_1\_4\_1\_1\_77\_1\_2  
gdcM::UIDs, 1179  
uid\_1\_2\_840\_10008\_5\_1\_4\_1\_1\_77\_1\_2\_1  
gdcM::UIDs, 1179  
uid\_1\_2\_840\_10008\_5\_1\_4\_1\_1\_77\_1\_3  
gdcM::UIDs, 1179  
uid\_1\_2\_840\_10008\_5\_1\_4\_1\_1\_77\_1\_4  
gdcM::UIDs, 1179  
uid\_1\_2\_840\_10008\_5\_1\_4\_1\_1\_77\_1\_4\_1  
gdcM::UIDs, 1179  
uid\_1\_2\_840\_10008\_5\_1\_4\_1\_1\_77\_1\_5\_1  
gdcM::UIDs, 1179  
uid\_1\_2\_840\_10008\_5\_1\_4\_1\_1\_77\_1\_5\_2  
gdcM::UIDs, 1179  
uid\_1\_2\_840\_10008\_5\_1\_4\_1\_1\_77\_1\_5\_3  
gdcM::UIDs, 1179  
uid\_1\_2\_840\_10008\_5\_1\_4\_1\_1\_77\_1\_5\_4  
gdcM::UIDs, 1179  
uid\_1\_2\_840\_10008\_5\_1\_4\_1\_1\_77\_1\_5\_5  
gdcM::UIDs, 1183  
uid\_1\_2\_840\_10008\_5\_1\_4\_1\_1\_77\_1\_5\_6  
gdcM::UIDs, 1183  
uid\_1\_2\_840\_10008\_5\_1\_4\_1\_1\_77\_1\_5\_7  
gdcM::UIDs, 1183  
uid\_1\_2\_840\_10008\_5\_1\_4\_1\_1\_77\_1\_5\_8  
gdcM::UIDs, 1183  
uid\_1\_2\_840\_10008\_5\_1\_4\_1\_1\_77\_1\_6  
gdcM::UIDs, 1181  
uid\_1\_2\_840\_10008\_5\_1\_4\_1\_1\_77\_2  
gdcM::UIDs, 1179  
uid\_1\_2\_840\_10008\_5\_1\_4\_1\_1\_78\_1  
gdcM::UIDs, 1183  
uid\_1\_2\_840\_10008\_5\_1\_4\_1\_1\_78\_2  
gdcM::UIDs, 1183  
uid\_1\_2\_840\_10008\_5\_1\_4\_1\_1\_78\_3  
gdcM::UIDs, 1183  
uid\_1\_2\_840\_10008\_5\_1\_4\_1\_1\_78\_4  
gdcM::UIDs, 1183  
uid\_1\_2\_840\_10008\_5\_1\_4\_1\_1\_78\_5  
gdcM::UIDs, 1183  
uid\_1\_2\_840\_10008\_5\_1\_4\_1\_1\_78\_6  
gdcM::UIDs, 1183  
uid\_1\_2\_840\_10008\_5\_1\_4\_1\_1\_78\_7  
gdcM::UIDs, 1183  
uid\_1\_2\_840\_10008\_5\_1\_4\_1\_1\_78\_8  
gdcM::UIDs, 1183  
uid\_1\_2\_840\_10008\_5\_1\_4\_1\_1\_79\_1  
gdcM::UIDs, 1183  
uid\_1\_2\_840\_10008\_5\_1\_4\_1\_1\_7\_1  
gdcM::UIDs, 1178  
uid\_1\_2\_840\_10008\_5\_1\_4\_1\_1\_7\_2  
gdcM::UIDs, 1178  
uid\_1\_2\_840\_10008\_5\_1\_4\_1\_1\_7\_3  
gdcM::UIDs, 1178  
uid\_1\_2\_840\_10008\_5\_1\_4\_1\_1\_7\_4  
gdcM::UIDs, 1178  
uid\_1\_2\_840\_10008\_5\_1\_4\_1\_1\_8  
gdcM::UIDs, 1178  
uid\_1\_2\_840\_10008\_5\_1\_4\_1\_1\_80\_1  
gdcM::UIDs, 1183  
uid\_1\_2\_840\_10008\_5\_1\_4\_1\_1\_81\_1  
gdcM::UIDs, 1183  
uid\_1\_2\_840\_10008\_5\_1\_4\_1\_1\_82\_1  
gdcM::UIDs, 1183  
uid\_1\_2\_840\_10008\_5\_1\_4\_1\_1\_88\_1  
gdcM::UIDs, 1179  
uid\_1\_2\_840\_10008\_5\_1\_4\_1\_1\_88\_11  
gdcM::UIDs, 1179  
uid\_1\_2\_840\_10008\_5\_1\_4\_1\_1\_88\_2  
gdcM::UIDs, 1179  
uid\_1\_2\_840\_10008\_5\_1\_4\_1\_1\_88\_22  
gdcM::UIDs, 1179  
uid\_1\_2\_840\_10008\_5\_1\_4\_1\_1\_88\_3  
gdcM::UIDs, 1179  
uid\_1\_2\_840\_10008\_5\_1\_4\_1\_1\_88\_33  
gdcM::UIDs, 1179  
uid\_1\_2\_840\_10008\_5\_1\_4\_1\_1\_88\_34  
gdcM::UIDs, 1183  
uid\_1\_2\_840\_10008\_5\_1\_4\_1\_1\_88\_35  
gdcM::UIDs, 1183  
uid\_1\_2\_840\_10008\_5\_1\_4\_1\_1\_88\_4  
gdcM::UIDs, 1179  
uid\_1\_2\_840\_10008\_5\_1\_4\_1\_1\_88\_40  
gdcM::UIDs, 1179  
uid\_1\_2\_840\_10008\_5\_1\_4\_1\_1\_88\_50  
gdcM::UIDs, 1179  
uid\_1\_2\_840\_10008\_5\_1\_4\_1\_1\_88\_59  
gdcM::UIDs, 1179  
uid\_1\_2\_840\_10008\_5\_1\_4\_1\_1\_88\_65  
gdcM::UIDs, 1179  
uid\_1\_2\_840\_10008\_5\_1\_4\_1\_1\_88\_67  
gdcM::UIDs, 1179  
uid\_1\_2\_840\_10008\_5\_1\_4\_1\_1\_88\_68  
gdcM::UIDs, 1183  
uid\_1\_2\_840\_10008\_5\_1\_4\_1\_1\_88\_69  
gdcM::UIDs, 1183  
uid\_1\_2\_840\_10008\_5\_1\_4\_1\_1\_88\_70  
gdcM::UIDs, 1183  
uid\_1\_2\_840\_10008\_5\_1\_4\_1\_1\_88\_71  
gdcM::UIDs, 1183  
uid\_1\_2\_840\_10008\_5\_1\_4\_1\_1\_88\_72  
gdcM::UIDs, 1183  
uid\_1\_2\_840\_10008\_5\_1\_4\_1\_1\_88\_73

gdcM::UIDs, 1183  
uid\_1\_2\_840\_10008\_5\_1\_4\_1\_1\_88\_74  
gdcM::UIDs, 1183  
uid\_1\_2\_840\_10008\_5\_1\_4\_1\_1\_88\_75  
gdcM::UIDs, 1183  
uid\_1\_2\_840\_10008\_5\_1\_4\_1\_1\_9  
gdcM::UIDs, 1178  
uid\_1\_2\_840\_10008\_5\_1\_4\_1\_1\_90\_1  
gdcM::UIDs, 1183  
uid\_1\_2\_840\_10008\_5\_1\_4\_1\_1\_9\_1  
gdcM::UIDs, 1178  
uid\_1\_2\_840\_10008\_5\_1\_4\_1\_1\_9\_1\_1  
gdcM::UIDs, 1178  
uid\_1\_2\_840\_10008\_5\_1\_4\_1\_1\_9\_1\_2  
gdcM::UIDs, 1178  
uid\_1\_2\_840\_10008\_5\_1\_4\_1\_1\_9\_1\_3  
gdcM::UIDs, 1178  
uid\_1\_2\_840\_10008\_5\_1\_4\_1\_1\_9\_2\_1  
gdcM::UIDs, 1178  
uid\_1\_2\_840\_10008\_5\_1\_4\_1\_1\_9\_3\_1  
gdcM::UIDs, 1178  
uid\_1\_2\_840\_10008\_5\_1\_4\_1\_1\_9\_4\_1  
gdcM::UIDs, 1178  
uid\_1\_2\_840\_10008\_5\_1\_4\_1\_1\_9\_4\_2  
gdcM::UIDs, 1182  
uid\_1\_2\_840\_10008\_5\_1\_4\_1\_1\_9\_5\_1  
gdcM::UIDs, 1182  
uid\_1\_2\_840\_10008\_5\_1\_4\_1\_1\_9\_6\_1  
gdcM::UIDs, 1182  
uid\_1\_2\_840\_10008\_5\_1\_4\_1\_2\_1\_1  
gdcM::UIDs, 1180  
uid\_1\_2\_840\_10008\_5\_1\_4\_1\_2\_1\_2  
gdcM::UIDs, 1180  
uid\_1\_2\_840\_10008\_5\_1\_4\_1\_2\_1\_3  
gdcM::UIDs, 1180  
uid\_1\_2\_840\_10008\_5\_1\_4\_1\_2\_2\_1  
gdcM::UIDs, 1180  
uid\_1\_2\_840\_10008\_5\_1\_4\_1\_2\_2\_2  
gdcM::UIDs, 1180  
uid\_1\_2\_840\_10008\_5\_1\_4\_1\_2\_2\_3  
gdcM::UIDs, 1180  
uid\_1\_2\_840\_10008\_5\_1\_4\_1\_2\_3\_1  
gdcM::UIDs, 1180  
uid\_1\_2\_840\_10008\_5\_1\_4\_1\_2\_3\_2  
gdcM::UIDs, 1180  
uid\_1\_2\_840\_10008\_5\_1\_4\_1\_2\_3\_3  
gdcM::UIDs, 1180  
uid\_1\_2\_840\_10008\_5\_1\_4\_1\_2\_4\_2  
gdcM::UIDs, 1184  
uid\_1\_2\_840\_10008\_5\_1\_4\_1\_2\_4\_3  
gdcM::UIDs, 1184  
uid\_1\_2\_840\_10008\_5\_1\_4\_1\_2\_5\_3  
gdcM::UIDs, 1184  
uid\_1\_2\_840\_10008\_5\_1\_4\_20\_1  
gdcM::UIDs, 1184  
uid\_1\_2\_840\_10008\_5\_1\_4\_20\_2  
gdcM::UIDs, 1184  
uid\_1\_2\_840\_10008\_5\_1\_4\_20\_3  
gdcM::UIDs, 1184  
uid\_1\_2\_840\_10008\_5\_1\_4\_31  
gdcM::UIDs, 1180  
uid\_1\_2\_840\_10008\_5\_1\_4\_32  
gdcM::UIDs, 1180  
uid\_1\_2\_840\_10008\_5\_1\_4\_32\_1  
gdcM::UIDs, 1180  
uid\_1\_2\_840\_10008\_5\_1\_4\_32\_2  
gdcM::UIDs, 1180  
uid\_1\_2\_840\_10008\_5\_1\_4\_32\_3  
gdcM::UIDs, 1180  
uid\_1\_2\_840\_10008\_5\_1\_4\_33  
gdcM::UIDs, 1180  
uid\_1\_2\_840\_10008\_5\_1\_4\_34\_1  
gdcM::UIDs, 1180  
uid\_1\_2\_840\_10008\_5\_1\_4\_34\_10  
gdcM::UIDs, 1184  
uid\_1\_2\_840\_10008\_5\_1\_4\_34\_2  
gdcM::UIDs, 1180  
uid\_1\_2\_840\_10008\_5\_1\_4\_34\_3  
gdcM::UIDs, 1180  
uid\_1\_2\_840\_10008\_5\_1\_4\_34\_4  
gdcM::UIDs, 1180  
uid\_1\_2\_840\_10008\_5\_1\_4\_34\_4\_1  
gdcM::UIDs, 1180  
uid\_1\_2\_840\_10008\_5\_1\_4\_34\_4\_2  
gdcM::UIDs, 1180  
uid\_1\_2\_840\_10008\_5\_1\_4\_34\_4\_3  
gdcM::UIDs, 1180  
uid\_1\_2\_840\_10008\_5\_1\_4\_34\_4\_4  
gdcM::UIDs, 1180  
uid\_1\_2\_840\_10008\_5\_1\_4\_34\_5  
gdcM::UIDs, 1180  
uid\_1\_2\_840\_10008\_5\_1\_4\_34\_5\_1  
gdcM::UIDs, 1184  
uid\_1\_2\_840\_10008\_5\_1\_4\_34\_6  
gdcM::UIDs, 1184  
uid\_1\_2\_840\_10008\_5\_1\_4\_34\_6\_1  
gdcM::UIDs, 1184  
uid\_1\_2\_840\_10008\_5\_1\_4\_34\_6\_2  
gdcM::UIDs, 1184  
uid\_1\_2\_840\_10008\_5\_1\_4\_34\_6\_3  
gdcM::UIDs, 1184  
uid\_1\_2\_840\_10008\_5\_1\_4\_34\_6\_4  
gdcM::UIDs, 1184  
uid\_1\_2\_840\_10008\_5\_1\_4\_34\_7  
gdcM::UIDs, 1184  
uid\_1\_2\_840\_10008\_5\_1\_4\_34\_8  
gdcM::UIDs, 1184  
uid\_1\_2\_840\_10008\_5\_1\_4\_34\_9

- gdcM::UIDs, [1184](#)
- uid\_1\_2\_840\_10008\_5\_1\_4\_37\_1
  - gdcM::UIDs, [1180](#)
- uid\_1\_2\_840\_10008\_5\_1\_4\_37\_2
  - gdcM::UIDs, [1180](#)
- uid\_1\_2\_840\_10008\_5\_1\_4\_37\_3
  - gdcM::UIDs, [1180](#)
- uid\_1\_2\_840\_10008\_5\_1\_4\_38\_1
  - gdcM::UIDs, [1180](#)
- uid\_1\_2\_840\_10008\_5\_1\_4\_38\_2
  - gdcM::UIDs, [1180](#)
- uid\_1\_2\_840\_10008\_5\_1\_4\_38\_3
  - gdcM::UIDs, [1180](#)
- uid\_1\_2\_840\_10008\_5\_1\_4\_38\_4
  - gdcM::UIDs, [1184](#)
- uid\_1\_2\_840\_10008\_5\_1\_4\_39\_1
  - gdcM::UIDs, [1184](#)
- uid\_1\_2\_840\_10008\_5\_1\_4\_39\_2
  - gdcM::UIDs, [1184](#)
- uid\_1\_2\_840\_10008\_5\_1\_4\_39\_3
  - gdcM::UIDs, [1184](#)
- uid\_1\_2\_840\_10008\_5\_1\_4\_39\_4
  - gdcM::UIDs, [1184](#)
- uid\_1\_2\_840\_10008\_5\_1\_4\_41
  - gdcM::UIDs, [1180](#)
- uid\_1\_2\_840\_10008\_5\_1\_4\_42
  - gdcM::UIDs, [1180](#)
- uid\_1\_2\_840\_10008\_5\_1\_4\_43\_1
  - gdcM::UIDs, [1184](#)
- uid\_1\_2\_840\_10008\_5\_1\_4\_43\_2
  - gdcM::UIDs, [1184](#)
- uid\_1\_2\_840\_10008\_5\_1\_4\_43\_3
  - gdcM::UIDs, [1184](#)
- uid\_1\_2\_840\_10008\_5\_1\_4\_43\_4
  - gdcM::UIDs, [1184](#)
- uid\_1\_2\_840\_10008\_5\_1\_4\_44\_1
  - gdcM::UIDs, [1184](#)
- uid\_1\_2\_840\_10008\_5\_1\_4\_44\_2
  - gdcM::UIDs, [1184](#)
- uid\_1\_2\_840\_10008\_5\_1\_4\_44\_3
  - gdcM::UIDs, [1184](#)
- uid\_1\_2\_840\_10008\_5\_1\_4\_44\_4
  - gdcM::UIDs, [1184](#)
- uid\_1\_2\_840\_10008\_5\_1\_4\_45\_1
  - gdcM::UIDs, [1184](#)
- uid\_1\_2\_840\_10008\_5\_1\_4\_45\_2
  - gdcM::UIDs, [1184](#)
- uid\_1\_2\_840\_10008\_5\_1\_4\_45\_3
  - gdcM::UIDs, [1184](#)
- uid\_1\_2\_840\_10008\_5\_1\_4\_45\_4
  - gdcM::UIDs, [1184](#)
- uid\_1\_2\_840\_10008\_7\_1\_1
  - gdcM::UIDs, [1184](#)
- uid\_1\_2\_840\_10008\_7\_1\_2
  - gdcM::UIDs, [1184](#)
- uid\_1\_2\_840\_10008\_8\_1\_1
  - gdcM::UIDs, [1184](#)
- UIDGenerator
  - gdcM::UIDGenerator, [1147](#)
- UINT12
  - gdcM::PixelFormat, [812](#)
- UINT16
  - gdcM::PixelFormat, [812](#)
- UINT32
  - gdcM::PixelFormat, [812](#)
- UINT64
  - gdcM::PixelFormat, [812](#)
- UINT8
  - gdcM::PixelFormat, [812](#)
- UL
  - gdcM::VR, [1289](#)
- ULAction
  - gdcM::network::ULAction, [1188](#), [1189](#)
- ULActionAE6
  - gdcM::network::ULConnection, [1235](#)
- ULBasicCallback
  - gdcM::network::ULBasicCallback, [1228](#)
- ULConnection
  - gdcM::network::ULConnection, [1231](#)
- ULConnectionCallback
  - gdcM::network::ULConnectionCallback, [1236](#)
- ULConnectionInfo
  - gdcM::network::ULConnectionInfo, [1238](#)
- ULConnectionManager
  - gdcM::network::ULConnection, [1235](#)
  - gdcM::network::ULConnectionManager, [1242](#)
- ULEvent
  - gdcM::network::ULEvent, [1248](#), [1249](#)
- ULTransitionTable
  - gdcM::network::ULTransitionTable, [1251](#)
- UltrasoundImageStorage
  - gdcM::MediaStorage, [679](#)
  - gdcM::UIDs, [1169](#)
- UltrasoundImageStorageRetired
  - gdcM::MediaStorage, [679](#)
  - gdcM::UIDs, [1169](#)
- UltrasoundMultiFrameImageStorage
  - gdcM::MediaStorage, [679](#)
- UltrasoundMultiframeImageStorage
  - gdcM::UIDs, [1168](#)
- UltrasoundMultiFrameImageStorageRetired
  - gdcM::MediaStorage, [679](#)
- UltrasoundMultiframeImageStorageRetired
  - gdcM::UIDs, [1168](#)
- ULWritingCallback
  - gdcM::network::ULWritingCallback, [1253](#)
- UN
  - gdcM::VR, [1289](#)

- UndefinedEntityError
  - gdcM::Parser, 782
- underline
  - gdcM::terminal, 85
- UnexpectedStateError
  - gdcM::Parser, 782
- UnifiedProcedureStepEventSOPClass
  - gdcM::UIDs, 1171
- UnifiedProcedureStepEventSOPClass1
  - gdcM::UIDs, 1175
- UnifiedProcedureStepPullSOPClass
  - gdcM::UIDs, 1171
- UnifiedProcedureStepPullSOPClass1
  - gdcM::UIDs, 1174
- UnifiedProcedureStepPushSOPClass
  - gdcM::UIDs, 1171
- UnifiedProcedureStepPushSOPClass1
  - gdcM::UIDs, 1174
- UnifiedProcedureStepWatchSOPClass
  - gdcM::UIDs, 1171
- UnifiedProcedureStepWatchSOPClass1
  - gdcM::UIDs, 1174
- UnifiedWorklistandProcedureStepServiceClass
  - gdcM::UIDs, 1171
- UnifiedWorklistandProcedureStepServiceClass1
  - gdcM::UIDs, 1174
- UnifiedWorklistandProcedureStepSOPInstance
  - gdcM::UIDs, 1171
- UnInstallPipeline
  - vtkImageColorViewer, 1377
- UniversalCoordinatedTime
  - gdcM::UIDs, 1175
- UNKNOWN
  - gdcM::CSAHeader, 288
  - gdcM::EquipmentManufacturer, 433
  - gdcM::LookupTable, 660
  - gdcM::Orientation, 764
  - gdcM::PhotometricInterpretation, 808
  - gdcM::PixelFormat, 812
  - gdcM::Spacing, 1018
  - gdcM::Surface, 1062
  - gdcM::Type, 1144
- Unknown
  - gdcM::SwapCode, 1085
  - gdcM::TransferSyntax, 1134
- Unpack
  - gdcM::Unpacker12Bits, 1260
- UnRegister
  - gdcM::Object, 752
- UnusedBitsPresentInPixelData
  - gdcM::Bitmap, 207
  - gdcM::Pixmap, 824
- Update
  - gdcM::Curve, 308
  - gdcM::Overlay, 776
- UpdateDisplayExtent
  - vtkImageColorViewer, 1377
- UpdateOrientation
  - vtkImageColorViewer, 1377
- UpdatePosition
  - gdcM::ByteBuffer, 218
- UPSFilteredGlobalSubscriptionSOPInstance
  - gdcM::UIDs, 1174
- UR
  - gdcM::VR, 1289
- URComp
  - gdcM, 60
- URI
  - gdcM::MediaStorage, 682
- US
  - gdcM::VR, 1289
- US\_OW
  - gdcM::VR, 1289
- US\_SS
  - gdcM::VR, 1289
- US\_SS\_OW
  - gdcM::VR, 1289
- Usage
  - gdcM::Usage, 1262
- UsageType
  - gdcM::Usage, 1261
- UseDictAlways
  - gdcM::PythonFilter, 883
  - gdcM::StringFilter, 1054
- UseGrayscaleSecondaryImageStorage
  - gdcM::EmptyMaskGenerator, 425
- UseOriginalSOPClassUID
  - gdcM::EmptyMaskGenerator, 425
- UserInformation
  - gdcM::network::UserInformation, 1264
- UserOption
  - gdcM::Usage, 1261
- UserOrdering
  - gdcM::SerieHelper, 978
- UT
  - gdcM::VR, 1289
- UTComp
  - gdcM, 60
- UV
  - gdcM::VR, 1289
- V
  - gdcM::Validate, 1269
- Valid
  - gdcM::Preamble, 844
- Validate
  - gdcM::PixelFormat, 818
  - gdcM::Validate, 1268



- ValidateQuery
  - gdcM::BaseQuery, [181](#)
  - gdcM::BaseRootQuery, [186](#)
  - gdcM::FindPatientRootQuery, [503](#)
  - gdcM::FindStudyRootQuery, [506](#)
  - gdcM::ModalityPerformedProcedureStepCreateQuery, [700](#)
  - gdcM::ModalityPerformedProcedureStepSetQuery, [703](#)
  - gdcM::MovePatientRootQuery, [717](#)
  - gdcM::MoveStudyRootQuery, [720](#)
  - gdcM::WLMFindQuery, [1417](#)
- Validation
  - gdcM::Validate, [1269](#)
- ValidDataSet
  - gdcM::BaseQuery, [181](#)
- Value
  - gdcM::Value, [1271](#)
- value
  - gdcM::SerieHelper, [979](#)
  - gdcM::STATIC\_ASSERTION\_FAILURE< true >, [1024](#)
- value\_type
  - gdcM::CodeString, [254](#)
  - gdcM::LO, [656](#)
  - gdcM::String< TDelimiter, TMaxLength, TPadChar >, [1048](#)
- ValueField
  - gdcM::DataElement, [322](#)
  - gdcM::PDBElement, [791](#)
- ValueLengthField
  - gdcM::DataElement, [322](#)
- ValueMultiplicityField
  - gdcM::CSAElement, [286](#)
- ValuePtr
  - gdcM::DataElement, [312](#)
- ValuesType
  - gdcM::Scanner, [930](#)
  - gdcM::StrictScanner, [1039](#)
- VERBOSE\_STYLE
  - gdcM::Printer, [865](#)
- VerificationSOPClass
  - gdcM::UIDs, [1166](#)
- Verify
  - gdcM::Defs, [351](#)
  - gdcM::Macro, [669](#)
  - gdcM::Module, [707](#)
- Version
  - gdcM::Version, [1275](#)
- VERTEX
  - gdcM::MeshPrimitive, [695](#)
- Video
  - gdcM::MediaStorage, [682](#)
- VideoEndoscopicImageStorage
  - gdcM::MediaStorage, [681](#)
  - gdcM::UIDs, [1169](#)
- VideoMicroscopicImageStorage
  - gdcM::MediaStorage, [681](#)
  - gdcM::UIDs, [1169](#)
- VideoPhotographicImageStorage
  - gdcM::MediaStorage, [681](#)
  - gdcM::UIDs, [1170](#)
- VIEWType
  - gdcM::Surface, [1062](#)
- VIEWType\_END
  - gdcM::Surface, [1062](#)
- VisualAcuityMeasurementsStorage
  - gdcM::UIDs, [1173](#)
- VL
  - gdcM::VL, [1278](#)
- VL16
  - gdcM::VR, [1289](#)
- VL32
  - gdcM::VR, [1289](#)
- VLEndoscopicImageStorage
  - gdcM::MediaStorage, [681](#)
  - gdcM::UIDs, [1169](#)
- VLImageStorageTrialRetired
  - gdcM::UIDs, [1169](#)
- VLMicroscopicImageStorage
  - gdcM::MediaStorage, [681](#)
  - gdcM::UIDs, [1169](#)
- VLMultiframeImageStorageTrialRetired
  - gdcM::UIDs, [1169](#)
- VLPhotographicImageStorage
  - gdcM::MediaStorage, [681](#)
  - gdcM::UIDs, [1170](#)
- VLSlideCoordinatesMicroscopicImageStorage
  - gdcM::UIDs, [1170](#)
- VLWholeSlideMicroscopyImageStorage
  - gdcM::MediaStorage, [681](#)
  - gdcM::UIDs, [1172](#)
- VM
  - gdcM::VM, [1284](#)
- VM0
  - gdcM::VM, [1283](#)
- VM1
  - gdcM::VM, [1283](#)
- VM10
  - gdcM::VM, [1283](#)
- VM12
  - gdcM::VM, [1283](#)
- VM16
  - gdcM::VM, [1283](#)
- VM18
  - gdcM::VM, [1283](#)
- VM1\_2
  - gdcM::VM, [1283](#)

- VM1\_3
  - gdcm::VM, [1283](#)
- VM1\_32
  - gdcm::VM, [1283](#)
- VM1\_4
  - gdcm::VM, [1283](#)
- VM1\_5
  - gdcm::VM, [1283](#)
- VM1\_8
  - gdcm::VM, [1283](#)
- VM1\_99
  - gdcm::VM, [1283](#)
- VM1\_n
  - gdcm::VM, [1283](#)
- VM2
  - gdcm::VM, [1283](#)
- VM24
  - gdcm::VM, [1283](#)
- VM256
  - gdcm::VM, [1283](#)
- VM28
  - gdcm::VM, [1283](#)
- VM2\_2n
  - gdcm::VM, [1283](#)
- VM2\_n
  - gdcm::VM, [1283](#)
- VM3
  - gdcm::VM, [1283](#)
- VM30\_30n
  - gdcm::VM, [1283](#)
- VM32
  - gdcm::VM, [1283](#)
- VM35
  - gdcm::VM, [1283](#)
- VM3\_3n
  - gdcm::VM, [1283](#)
- VM3\_4
  - gdcm::VM, [1283](#)
- VM3\_n
  - gdcm::VM, [1283](#)
- VM4
  - gdcm::VM, [1283](#)
- VM47\_47n
  - gdcm::VM, [1283](#)
- VM4\_4n
  - gdcm::VM, [1283](#)
- VM5
  - gdcm::VM, [1283](#)
- VM6
  - gdcm::VM, [1283](#)
- VM6\_6n
  - gdcm::VM, [1283](#)
- VM6\_n
  - gdcm::VM, [1283](#)
- VM7\_7n
  - gdcm::VM, [1283](#)
- VM8
  - gdcm::VM, [1283](#)
- VM9
  - gdcm::VM, [1283](#)
- VM99
  - gdcm::VM, [1283](#)
- VM\_END
  - gdcm::VM, [1283](#)
- VMType
  - gdcm::Attribute< Group, Element, TVR, TVM >, [137](#)
  - gdcm::Attribute< Group, Element, TVR, VM::VM1 >, [146](#)
  - gdcm::VM, [1283](#)
- VOILUTBoxSOPClass
  - gdcm::UIDs, [1168](#)
- VolumeRenderingVolumetricPresentationStateStorage
  - gdcm::UIDs, [1173](#)
- VR
  - gdcm::VR, [1289](#)
- VR\_END
  - gdcm::VR, [1289](#)
- VR\_VM1
  - gdcm::VR, [1289](#)
- VRALL
  - gdcm::VR, [1289](#)
- VRASCII
  - gdcm::VR, [1289](#)
- VRBINARY
  - gdcm, [76](#)
  - gdcm::VR, [1289](#)
- VRField
  - gdcm::CSAElement, [286](#)
  - gdcm::DataElement, [322](#)
- VRType
  - gdcm::VR, [1288](#)
- VRTypeTemplateCase
  - gdcmVR.h, [1707](#)
- VT100
  - gdcm::terminal, [86](#)
- VTK\_CMYK
  - vtkGDCMImageReader.h, [1714](#)
  - vtkGDCMImageReader2.h, [1715](#)
- VTK\_INVERSE\_LUMINANCE
  - vtkGDCMImageReader.h, [1714](#)
  - vtkGDCMImageReader2.h, [1715](#)
- VTK\_LEGACY
  - vtkImageColorViewer, [1377](#), [1378](#)
- VTK\_LOOKUP\_TABLE
  - vtkGDCMImageReader.h, [1714](#)
  - vtkGDCMImageReader2.h, [1716](#)
- VTK\_YBR
  - vtkGDCMImageReader.h, [1714](#)

- vtkGDCMImageReader2.h, 1716
- vtkBooleanMacro
  - vtkGDCMImageReader, 1304, 1305
  - vtkGDCMImageReader2, 1319, 1320
  - vtkGDCMImageWriter, 1332
  - vtkGDCMThreadedImageReader, 1357
  - vtkGDCMThreadedImageReader2, 1362
  - vtkImageColorViewer, 1378
  - vtkImageMapToColors16, 1385
- vtkGDCMImageReader, 1298
  - ~vtkGDCMImageReader, 1301
  - ApplyInverseVideo, 1309
  - ApplyLookupTable, 1310
  - ApplyPlanarConfiguration, 1310
  - ApplyShiftScale, 1310
  - ApplyYBRToRGB, 1310
  - CanReadFile, 1301
  - Curve, 1310
  - DirectionCosines, 1310
  - ExecuteData, 1301
  - ExecuteInformation, 1302
  - FileNames, 1310
  - FillMedicalImageInformation, 1302
  - ForceRescale, 1311
  - GetDescriptiveName, 1302
  - GetFileExtensions, 1302
  - GetIconImage, 1302
  - GetOverlay, 1302
  - IconDataScalarType, 1311
  - IconImageDataExtent, 1311
  - IconNumberOfScalarComponents, 1311
  - ImageFormat, 1311
  - ImageOrientationPatient, 1311
  - ImagePositionPatient, 1311
  - LoadIconImage, 1312
  - LoadOverlays, 1312
  - LoadSingleFile, 1302
  - LossyFlag, 1312
  - MedicalImageProperties, 1312
  - New, 1303
  - NumberOfIconImages, 1312
  - NumberOfOverlays, 1312
  - PlanarConfiguration, 1312
  - PrintSelf, 1303
  - RequestDataCompat, 1303
  - RequestInformationCompat, 1303
  - Scale, 1313
  - SetCurve, 1303
  - SetFileNames, 1304
  - SetFilePattern, 1304
  - SetFilePrefix, 1304
  - SetMedicalImageProperties, 1304
  - Shift, 1313
  - vtkBooleanMacro, 1304, 1305
  - vtkGDCMImageReader, 1301
  - vtkGDCMMedicalImageProperties, 1339
  - vtkGetMacro, 1305–1307
  - vtkGetObjectMacro, 1307
  - vtkGetStringMacro, 1308
  - vtkGetVector3Macro, 1308
  - vtkGetVector6Macro, 1308
  - vtkSetMacro, 1308, 1309
  - vtkSetVector6Macro, 1309
  - vtkTypeMacro, 1309
- vtkGDCMImageReader.h, 1713
  - VTK\_CMYK, 1714
  - VTK\_INVERSE\_LUMINANCE, 1714
  - VTK\_LOOKUP\_TABLE, 1714
  - VTK\_YBR, 1714
- vtkGDCMImageReader2, 1313
  - ~vtkGDCMImageReader2, 1316
  - ApplyInverseVideo, 1324
  - ApplyLookupTable, 1324
  - ApplyPlanarConfiguration, 1324
  - ApplyShiftScale, 1325
  - ApplyYBRToRGB, 1325
  - CanReadFile, 1316
  - Curve, 1325
  - DirectionCosines, 1325
  - FillMedicalImageInformation, 1316
  - ForceRescale, 1325
  - GetDescriptiveName, 1316
  - GetFileExtensions, 1316
  - GetIconImage, 1317
  - GetIconImagePort, 1317
  - GetOverlay, 1317
  - GetOverlayPort, 1317
  - IconDataScalarType, 1325
  - IconImageDataExtent, 1325
  - IconNumberOfScalarComponents, 1326
  - ImageFormat, 1326
  - ImageOrientationPatient, 1326
  - ImagePositionPatient, 1326
  - LoadIconImage, 1326
  - LoadOverlays, 1326
  - LoadSingleFile, 1317
  - LossyFlag, 1326
  - New, 1317
  - NumberOfIconImages, 1327
  - NumberOfOverlays, 1327
  - PlanarConfiguration, 1327
  - PrintSelf, 1318
  - ProcessRequest, 1318
  - RequestData, 1318
  - RequestDataCompat, 1318
  - RequestInformation, 1318
  - RequestInformationCompat, 1319
  - Scale, 1327

- SetCurve, 1319
- SetFilePattern, 1319
- SetFilePrefix, 1319
- SetMedicalImageProperties, 1319
- Shift, 1327
- vtkBooleanMacro, 1319, 1320
- vtkGDCMImageReader2, 1316
- vtkGDCMMedicalImageProperties, 1340
- vtkGetMacro, 1320–1322
- vtkGetObjectMacro, 1322
- vtkGetStringMacro, 1322, 1323
- vtkGetVector3Macro, 1323
- vtkGetVector6Macro, 1323
- vtkSetMacro, 1323, 1324
- vtkSetVector6Macro, 1324
- vtkTypeMacro, 1324
- vtkGDCMImageReader2.h, 1715
  - VTK\_CMYK, 1715
  - VTK\_INVERSE\_LUMINANCE, 1715
  - VTK\_LOOKUP\_TABLE, 1716
  - VTK\_YBR, 1716
- vtkGDCMImageWriter, 1328
  - ~vtkGDCMImageWriter, 1330
  - CompressionTypes, 1330
  - GetDescriptiveName, 1330
  - GetFileExtensions, 1331
  - GetFileName, 1331
  - JPEG2000\_COMPRESSION, 1330
  - JPEG\_COMPRESSION, 1330
  - JPEGLS\_COMPRESSION, 1330
  - New, 1331
  - NO\_COMPRESSION, 1330
  - PrintSelf, 1331
  - RLE\_COMPRESSION, 1330
  - SetDirectionCosines, 1331
  - SetDirectionCosinesFromImageOrientationPatient, 1331
  - SetFileNames, 1332
  - SetMedicalImageProperties, 1332
  - vtkBooleanMacro, 1332
  - vtkGDCMImageWriter, 1330
  - vtkGDCMMedicalImageProperties, 1340
  - vtkGetMacro, 1332, 1333
  - vtkGetObjectMacro, 1334
  - vtkGetStringMacro, 1334
  - vtkSetMacro, 1334, 1335
  - vtkSetStringMacro, 1336
  - vtkTypeMacro, 1336
  - Write, 1336
  - WriteGDCMData, 1336
  - WriteSlice, 1337
- vtkGDCMImageWriter.h, 1716
- vtkGDCMMedicalImageProperties, 1337
  - ~vtkGDCMMedicalImageProperties, 1338
  - Clear, 1338
  - GetFile, 1339
  - New, 1339
  - PrintSelf, 1339
  - PushBackFile, 1339
  - vtkGDCMImageReader, 1339
  - vtkGDCMImageReader2, 1340
  - vtkGDCMImageWriter, 1340
  - vtkGDCMMedicalImageProperties, 1338
  - vtkTypeMacro, 1339
- vtkGDCMMedicalImageProperties.h, 1717
- vtkGDCMPolyDataReader, 1340
  - ~vtkGDCMPolyDataReader, 1342
  - FileName, 1345
  - FillMedicalImageInformation, 1342
  - MedicalImageProperties, 1345
  - New, 1342
  - PrintSelf, 1342
  - RequestData, 1343
  - RequestData\_HemodynamicWaveformStorage, 1343
  - RequestData\_RTStructureSetStorage, 1343
  - RequestInformation, 1343
  - RequestInformation\_HemodynamicWaveformStorage, 1343
  - RequestInformation\_RTStructureSetStorage, 1343
  - RTStructSetProperties, 1345
  - vtkGDCMPolyDataReader, 1342
  - vtkGetObjectMacro, 1344
  - vtkGetStringMacro, 1344
  - vtkSetStringMacro, 1344
  - vtkTypeMacro, 1344
- vtkGDCMPolyDataReader.h, 1717
- vtkGDCMPolyDataWriter, 1345
  - ~vtkGDCMPolyDataWriter, 1347
  - InitializeRTStructSet, 1347
  - MedicalImageProperties, 1349
  - New, 1347
  - PrintSelf, 1348
  - RTStructSetProperties, 1350
  - SetMedicalImageProperties, 1348
  - SetNumberOfInputPorts, 1348
  - SetRTStructSetProperties, 1348
  - vtkGDCMPolyDataWriter, 1347
  - vtkTypeMacro, 1349
  - WriteData, 1349
  - WriteRTSTRUCTData, 1349
  - WriteRTSTRUCTInfo, 1349
- vtkGDCMPolyDataWriter.h, 1718
- vtkGDCMTesting, 1350
  - ~vtkGDCMTesting, 1352
  - GetGDCMDataRoot, 1352
  - GetMD5MetaImage, 1352
  - GetMHDMD5FromFile, 1352

- GetNumberOfMD5MetalImages, [1352](#)
- GetRAWMD5FromFile, [1353](#)
- GetVTKDataRoot, [1353](#)
- MD5MetalImagesType, [1351](#)
- New, [1353](#)
- PrintSelf, [1353](#)
- vtkGDCMTesting, [1351](#)
- vtkTypeMacro, [1353](#)
- vtkGDCMTesting.h, [1719](#)
- vtkGDCMThreadedImageReader, [1354](#)
  - ~vtkGDCMThreadedImageReader, [1356](#)
  - ExecuteData, [1356](#)
  - ExecuteInformation, [1356](#)
  - New, [1356](#)
  - PrintSelf, [1356](#)
  - ReadFiles, [1356](#)
  - RequestDataCompat, [1357](#)
  - vtkBooleanMacro, [1357](#)
  - vtkGDCMThreadedImageReader, [1355](#)
  - vtkGetMacro, [1357](#)
  - vtkSetMacro, [1357](#)
  - vtkTypeMacro, [1358](#)
- vtkGDCMThreadedImageReader.h, [1719](#)
- vtkGDCMThreadedImageReader2, [1358](#)
  - ~vtkGDCMThreadedImageReader2, [1360](#)
  - GetFileName, [1360](#)
  - New, [1360](#)
  - PrintSelf, [1360](#)
  - RequestInformation, [1361](#)
  - SetFileName, [1361](#)
  - SetFileNames, [1361](#)
  - SplitExtent, [1361](#)
  - ThreadedRequestData, [1361](#)
  - vtkBooleanMacro, [1362](#)
  - vtkGDCMThreadedImageReader2, [1360](#)
  - vtkGetMacro, [1362](#), [1363](#)
  - vtkGetObjectMacro, [1364](#)
  - vtkGetVector3Macro, [1364](#)
  - vtkGetVector6Macro, [1364](#)
  - vtkSetMacro, [1364](#), [1365](#)
  - vtkSetVector3Macro, [1365](#), [1366](#)
  - vtkSetVector6Macro, [1366](#)
  - vtkTypeMacro, [1366](#)
- vtkGDCMThreadedImageReader2.h, [1720](#)
- vtkGetMacro
  - vtkGDCMImageReader, [1305–1307](#)
  - vtkGDCMImageReader2, [1320–1322](#)
  - vtkGDCMImageWriter, [1332](#), [1333](#)
  - vtkGDCMThreadedImageReader, [1357](#)
  - vtkGDCMThreadedImageReader2, [1362](#), [1363](#)
  - vtkImageColorViewer, [1378](#)
  - vtkImageMapToColors16, [1386](#)
  - vtkImageMapToWindowLevelColors2, [1390](#), [1391](#)
- vtkGetObjectMacro
  - vtkGDCMImageReader, [1307](#)
  - vtkGDCMImageReader2, [1322](#)
  - vtkGDCMImageWriter, [1334](#)
  - vtkGDCMPolyDataReader, [1344](#)
  - vtkGDCMThreadedImageReader2, [1364](#)
  - vtkImageColorViewer, [1378](#), [1379](#)
  - vtkImageMapToColors16, [1386](#)
- vtkGetStringMacro
  - vtkGDCMImageReader, [1308](#)
  - vtkGDCMImageReader2, [1322](#), [1323](#)
  - vtkGDCMImageWriter, [1334](#)
  - vtkGDCMPolyDataReader, [1344](#)
  - vtkRTStructSetProperties, [1410](#), [1411](#)
- vtkGetVector3Macro
  - vtkGDCMImageReader, [1308](#)
  - vtkGDCMImageReader2, [1323](#)
  - vtkGDCMThreadedImageReader2, [1364](#)
- vtkGetVector6Macro
  - vtkGDCMImageReader, [1308](#)
  - vtkGDCMImageReader2, [1323](#)
  - vtkGDCMThreadedImageReader2, [1364](#)
- vtkImageColorViewer, [1367](#)
  - ~vtkImageColorViewer, [1370](#)
  - AddInput, [1370](#)
  - AddInputConnection, [1370](#)
  - FirstRender, [1380](#)
  - GetColorLevel, [1370](#)
  - GetColorWindow, [1371](#)
  - GetInput, [1371](#)
  - GetOffScreenRendering, [1371](#)
  - GetOverlayVisibility, [1371](#)
  - GetPosition, [1371](#)
  - GetSize, [1371](#)
  - GetSliceMax, [1371](#)
  - GetSliceMin, [1372](#)
  - GetSliceRange, [1372](#)
  - GetWindowName, [1372](#)
  - ImageActor, [1380](#)
  - InstallPipeline, [1372](#)
  - Interactor, [1380](#)
  - InteractorStyle, [1380](#)
  - New, [1372](#)
  - OverlayImageActor, [1380](#)
  - PrintSelf, [1373](#)
  - Render, [1373](#)
  - Renderer, [1380](#)
  - RenderWindow, [1381](#)
  - SetColorLevel, [1373](#)
  - SetColorWindow, [1373](#)
  - SetDisplayId, [1373](#)
  - SetInput, [1374](#)
  - SetInputConnection, [1374](#)
  - SetOffScreenRendering, [1374](#)
  - SetOverlayVisibility, [1374](#)

- SetParentId, [1374](#)
- SetPosition, [1374](#), [1375](#)
- SetRenderer, [1375](#)
- SetRenderWindow, [1375](#)
- SetSize, [1375](#)
- SetSlice, [1376](#)
- SetSliceOrientation, [1376](#)
- SetSliceOrientationToXY, [1376](#)
- SetSliceOrientationToXZ, [1376](#)
- SetSliceOrientationToYZ, [1376](#)
- SetupInteractor, [1376](#)
- SetWindowId, [1377](#)
- Slice, [1381](#)
- SLICE\_ORIENTATION\_XY, [1370](#)
- SLICE\_ORIENTATION\_XZ, [1370](#)
- SLICE\_ORIENTATION\_YZ, [1370](#)
- SliceOrientation, [1381](#)
- UnInstallPipeline, [1377](#)
- UpdateDisplayExtent, [1377](#)
- UpdateOrientation, [1377](#)
- VTK\_LEGACY, [1377](#), [1378](#)
- vtkBooleanMacro, [1378](#)
- vtkGetMacro, [1378](#)
- vtkGetObjectMacro, [1378](#), [1379](#)
- vtkImageColorViewer, [1370](#)
- vtkImageColorViewerCallback, [1380](#)
- vtkTypeMacro, [1379](#)
- WindowLevel, [1381](#)
- vtkImageColorViewer.h, [1720](#)
- vtkImageColorViewerCallback
  - vtkImageColorViewer, [1380](#)
- vtkImageMapToColors16, [1382](#)
  - ~vtkImageMapToColors16, [1383](#)
  - ActiveComponent, [1387](#)
  - DataWasPassed, [1387](#)
  - GetMTime, [1384](#)
  - LookupTable, [1387](#)
  - New, [1384](#)
  - OutputFormat, [1387](#)
  - PassAlphaToOutput, [1388](#)
  - PrintSelf, [1384](#)
  - RequestData, [1384](#)
  - RequestInformation, [1384](#)
  - SetLookupTable, [1384](#)
  - SetOutputFormatToLuminance, [1385](#)
  - SetOutputFormatToLuminanceAlpha, [1385](#)
  - SetOutputFormatToRGB, [1385](#)
  - SetOutputFormatToRGBA, [1385](#)
  - ThreadedRequestData, [1385](#)
  - vtkBooleanMacro, [1385](#)
  - vtkGetMacro, [1386](#)
  - vtkGetObjectMacro, [1386](#)
  - vtkImageMapToColors16, [1383](#)
  - vtkSetMacro, [1386](#), [1387](#)
  - vtkTypeMacro, [1387](#)
- vtkImageMapToColors16.h, [1721](#)
- vtkImageMapToWindowLevelColors2, [1388](#)
  - ~vtkImageMapToWindowLevelColors2, [1389](#)
  - Level, [1391](#)
  - New, [1390](#)
  - PrintSelf, [1390](#)
  - RequestData, [1390](#)
  - RequestInformation, [1390](#)
  - ThreadedRequestData, [1390](#)
  - vtkGetMacro, [1390](#), [1391](#)
  - vtkImageMapToWindowLevelColors2, [1389](#)
  - vtkSetMacro, [1391](#)
  - vtkTypeMacro, [1391](#)
  - Window, [1392](#)
- vtkImageMapToWindowLevelColors2.h, [1721](#)
- vtkImagePlanarComponentsToComponents, [1392](#)
  - ~vtkImagePlanarComponentsToComponents, [1393](#)
  - New, [1393](#)
  - PrintSelf, [1393](#)
  - RequestData, [1394](#)
  - vtkImagePlanarComponentsToComponents, [1393](#)
  - vtkTypeMacro, [1394](#)
- vtkImagePlanarComponentsToComponents.h, [1722](#)
- vtkImageRGBToYBR, [1394](#)
  - ~vtkImageRGBToYBR, [1395](#)
  - New, [1396](#)
  - PrintSelf, [1396](#)
  - ThreadedExecute, [1396](#)
  - vtkImageRGBToYBR, [1395](#)
  - vtkTypeMacro, [1396](#)
- vtkImageRGBToYBR.h, [1722](#)
- vtkImageYBRToRGB, [1397](#)
  - ~vtkImageYBRToRGB, [1398](#)
  - New, [1398](#)
  - PrintSelf, [1398](#)
  - ThreadedExecute, [1398](#)
  - vtkImageYBRToRGB, [1398](#)
  - vtkTypeMacro, [1399](#)
- vtkImageYBRToRGB.h, [1723](#)
- vtkLookupTable16, [1399](#)
  - ~vtkLookupTable16, [1401](#)
  - Build, [1401](#)
  - GetPointer, [1401](#)
  - MapScalarsThroughTable2, [1401](#)
  - New, [1401](#)
  - PrintSelf, [1402](#)
  - SetNumberOfTableValues, [1402](#)
  - Table16, [1402](#)
  - vtkLookupTable16, [1400](#)
  - vtkTypeMacro, [1402](#)
  - WritePointer, [1402](#)
- vtkLookupTable16.h, [1723](#)
- vtkRTStructSetProperties, [1403](#)



- ~vtkRTStructSetProperties, [1405](#)
- AddContourReferencedFrameOfReference, [1405](#)
- AddReferencedFrameOfReference, [1406](#)
- AddStructureSetROI, [1406](#)
- AddStructureSetROIObservation, [1406](#)
- Clear, [1406](#)
- DeepCopy, [1406](#)
- GetContourReferencedFrameOfReferenceClassUID, [1407](#)
- GetContourReferencedFrameOfReferenceInstanceUID, [1407](#)
- GetNumberOfContourReferencedFrameOfReferences, [1407](#)
- GetNumberOfReferencedFrameOfReferences, [1407](#)
- GetNumberOfStructureSetROIs, [1407](#)
- GetReferencedFrameOfReferenceClassUID, [1408](#)
- GetReferencedFrameOfReferenceInstanceUID, [1408](#)
- GetStructureSetObservationNumber, [1408](#)
- GetStructureSetROIDescription, [1408](#)
- GetStructureSetROIGenerationAlgorithm, [1408](#)
- GetStructureSetROIName, [1408](#)
- GetStructureSetROINumber, [1409](#)
- GetStructureSetROIObservationLabel, [1409](#)
- GetStructureSetROIRefFrameRefUID, [1409](#)
- GetStructureSetRTROIInterpretedType, [1409](#)
- Internals, [1413](#)
- New, [1409](#)
- PrintSelf, [1409](#)
- ReferenceFrameOfReferenceUID, [1413](#)
- ReferenceSeriesInstanceUID, [1413](#)
- SeriesInstanceUID, [1413](#)
- SOPInstanceUID, [1413](#)
- StructureSetDate, [1414](#)
- StructureSetLabel, [1414](#)
- StructureSetName, [1414](#)
- StructureSetTime, [1414](#)
- StudyInstanceUID, [1414](#)
- vtkGetStringMacro, [1410](#), [1411](#)
- vtkRTStructSetProperties, [1405](#)
- vtkSetStringMacro, [1411](#), [1412](#)
- vtkTypeMacro, [1413](#)
- vtkRTStructSetProperties.h, [1724](#)
- vtkSetMacro
  - vtkGDCMImageReader, [1308](#), [1309](#)
  - vtkGDCMImageReader2, [1323](#), [1324](#)
  - vtkGDCMImageWriter, [1334](#), [1335](#)
  - vtkGDCMThreadedImageReader, [1357](#)
  - vtkGDCMThreadedImageReader2, [1364](#), [1365](#)
  - vtkImageMapToColors16, [1386](#), [1387](#)
  - vtkImageMapToWindowLevelColors2, [1391](#)
- vtkSetStringMacro
  - vtkGDCMImageWriter, [1336](#)
  - vtkGDCMPolyDataReader, [1344](#)
  - vtkRTStructSetProperties, [1411](#), [1412](#)
- vtkSetVector3Macro
  - vtkGDCMThreadedImageReader2, [1365](#), [1366](#)
- vtkSetVector6Macro
  - vtkGDCMImageReader, [1309](#)
  - vtkGDCMImageReader2, [1324](#)
  - vtkGDCMThreadedImageReader2, [1366](#)
- vtkTypeMacro
  - vtkGDCMImageReader, [1309](#)
  - vtkGDCMImageReader2, [1324](#)
  - vtkGDCMImageWriter, [1336](#)
  - vtkGDCMMedicalImageProperties, [1339](#)
  - vtkGDCMPolyDataReader, [1344](#)
  - vtkGDCMPolyDataWriter, [1349](#)
  - vtkGDCMTesting, [1353](#)
  - vtkGDCMThreadedImageReader, [1358](#)
  - vtkGDCMThreadedImageReader2, [1366](#)
  - vtkImageColorViewer, [1379](#)
  - vtkImageMapToColors16, [1387](#)
  - vtkImageMapToWindowLevelColors2, [1391](#)
  - vtkImagePlanarComponentsToComponents, [1394](#)
  - vtkImageRGBToYBR, [1396](#)
  - vtkImageYBRToRGB, [1399](#)
  - vtkLookupTable16, [1402](#)
  - vtkRTStructSetProperties, [1413](#)
- WarningOff
  - gdcm::Trace, [1132](#)
- WarningOn
  - gdcm::Trace, [1132](#)
- Waveform
  - gdcm::MediaStorage, [682](#)
  - gdcm::Waveform, [1415](#)
- WaveformStorageTrialRetired
  - gdcm::UIDs, [1169](#)
- WeirdPapryus
  - gdcm::TransferSyntax, [1135](#)
- what
  - gdcm::Exception, [439](#)
- white
  - gdcm::terminal, [85](#)
- WideFieldOphthalmicPhotography3DCoordinatesImageStorage
  - gdcm::UIDs, [1173](#)
- WideFieldOphthalmicPhotographyStereographicProjectionImageStorage
  - gdcm::UIDs, [1173](#)
- Window
  - vtkImageMapToWindowLevelColors2, [1392](#)
- WindowLevel
  - vtkImageColorViewer, [1381](#)
- WinterColorPaletteSOPInstance
  - gdcm::UIDs, [1172](#)
- WIREFRAME
  - gdcm::Surface, [1062](#)
- WLMFindQuery
  - gdcm::WLMFindQuery, [1416](#)

## Write

- gdcm::ByteValue, [231](#)
- gdcm::CommandDataSet, [262](#)
- gdcm::DataElement, [321](#)
- gdcm::DataSet, [339](#)
- gdcm::Element< TVR, TVM >, [400](#)
- gdcm::Element< TVR, VM::VM1\_n >, [407](#)
- gdcm::EncodingImplementation< VR::VRASCII >, [429](#)
- gdcm::EncodingImplementation< VR::VRBINARY >, [430](#)
- gdcm::ExplicitDataElement, [443](#)
- gdcm::File, [451](#)
- gdcm::FileAnonymizer, [456](#)
- gdcm::FileMetaInformation, [478](#)
- gdcm::Fragment, [510](#)
- gdcm::ImageWriter, [588](#)
- gdcm::ImplicitDataElement, [595](#)
- gdcm::Item, [614](#)
- gdcm::network::AAbortPDU, [89](#)
- gdcm::network::AAssociateACPDU, [93](#)
- gdcm::network::AAssociateRJPDU, [96](#)
- gdcm::network::AAssociateRQPDU, [102](#)
- gdcm::network::AbstractSyntax, [106](#)
- gdcm::network::ApplicationContext, [121](#)
- gdcm::network::AReleaseRPPDU, [126](#)
- gdcm::network::AReleaseRQPDU, [128](#)
- gdcm::network::AsynchronousOperationsWindowSub, [134](#)
- gdcm::network::BasePDU, [177](#)
- gdcm::network::ImplementationClassUIDSub, [590](#)
- gdcm::network::ImplementationUIDSub, [591](#)
- gdcm::network::ImplementationVersionNameSub, [592](#)
- gdcm::network::MaximumLengthSub, [674](#)
- gdcm::network::PDataTFPDU, [788](#)
- gdcm::network::PresentationContextAC, [851](#)
- gdcm::network::PresentationContextRQ, [859](#)
- gdcm::network::PresentationDataValue, [863](#)
- gdcm::network::RoleSelectionSub, [926](#)
- gdcm::network::ServiceClassApplicationInformation, [981](#)
- gdcm::network::SOPClassExtendedNegotiationSub, [1008](#)
- gdcm::network::TransferSyntaxSub, [1141](#)
- gdcm::network::UserInformation, [1266](#)
- gdcm::PGXCodec, [806](#)
- gdcm::PixmapWriter, [836](#)
- gdcm::PNMCodec, [840](#)
- gdcm::Preamble, [844](#)
- gdcm::SegmentWriter, [956](#)
- gdcm::SequenceOfFragments, [963](#)
- gdcm::SequenceOfItems, [972](#)
- gdcm::StreamImageWriter, [1032](#)
- gdcm::SurfaceWriter, [1083](#)
- gdcm::Tag, [1115](#)
- gdcm::ValueIO< TDE, TSwap, TType >, [1273](#)
- gdcm::VL, [1280](#)
- gdcm::VR, [1293](#)
- gdcm::VRVLSIZE< 0 >, [1297](#)
- gdcm::VRVLSIZE< 1 >, [1298](#)
- gdcm::Writer, [1423](#)
- vtkGDCMImageWriter, [1336](#)
- Write16
  - gdcm::VL, [1280](#)
- WriteASCII
  - gdcm::Element< TVR, VM::VM1\_n >, [408](#)
- WriteBuffer
  - gdcm::ByteValue, [231](#)
  - gdcm::SequenceOfFragments, [964](#)
- WriteBufferAsRGBA
  - gdcm::LookupTable, [665](#)
- WriteData
  - vtkGDCMPolyDataWriter, [1349](#)
- WriteFooter
  - gdcm::DictConverter, [368](#)
- WriteGDCMData
  - vtkGDCMImageWriter, [1336](#)
- WriteHeader
  - gdcm::DictConverter, [368](#)
- WriteHelpFile
  - gdcm::BaseQuery, [182](#)
- WriteImageInformation
  - gdcm::StreamImageWriter, [1033](#)
- WriteImageSubregionRAW
  - gdcm::StreamImageWriter, [1033](#)
- WritePointer
  - vtkLookupTable16, [1402](#)
- WriteQuery
  - gdcm::BaseQuery, [182](#)
- Writer
  - gdcm::Writer, [1421](#)
- WriteRawHeader
  - gdcm::StreamImageWriter, [1033](#)
- WriteRTSTRUCTData
  - vtkGDCMPolyDataWriter, [1349](#)
- WriteRTSTRUCTInfo
  - vtkGDCMPolyDataWriter, [1349](#)
- WriteSlice
  - vtkGDCMImageWriter, [1337](#)
- x16printf
  - gdcm, [76](#)
- XAXRFGrayscaleSoftcopyPresentationStateStorage
  - gdcm::UIDs, [1173](#)
- XML
  - gdcm::Printer, [865](#)
- XMLDictReader



- gdcM::XMLDictReader, [1425](#)
- XMLEncoding
  - gdcM::UIDs, [1166](#)
- XMLPrinter
  - gdcM::XMLPrinter, [1429](#)
- XMLPrivateDictReader
  - gdcM::XMLPrivateDictReader, [1432](#)
- XRay3DAngiographicImageStorage
  - gdcM::MediaStorage, [681](#)
  - gdcM::UIDs, [1169](#)
- XRay3DCraniofacialImageStorage
  - gdcM::MediaStorage, [681](#)
  - gdcM::UIDs, [1169](#)
- XRayAngiographicBiPlaneImageStorageRetired
  - gdcM::MediaStorage, [680](#)
  - gdcM::UIDs, [1169](#)
- XRayAngiographicImageStorage
  - gdcM::MediaStorage, [680](#)
  - gdcM::UIDs, [1169](#)
- XRayRadiationDoseSR
  - gdcM::MediaStorage, [681](#)
- XRayRadiationDoseSRStorage
  - gdcM::UIDs, [1170](#)
- XRayRadiofluoroscopicImageStorage
  - gdcM::UIDs, [1169](#)
- XRayRadiofluoroscopicImageStorage
  - gdcM::MediaStorage, [680](#)
- YBR2RGB
  - gdcM::ImageChangePhotometricInterpretation, [539](#)
- YBR\_FULL
  - gdcM::PhotometricInterpretation, [808](#)
- YBR\_FULL\_422
  - gdcM::PhotometricInterpretation, [808](#)
- YBR\_ICT
  - gdcM::PhotometricInterpretation, [808](#)
- YBR\_PARTIAL\_420
  - gdcM::PhotometricInterpretation, [808](#)
- YBR\_PARTIAL\_422
  - gdcM::PhotometricInterpretation, [808](#)
- YBR\_RCT
  - gdcM::PhotometricInterpretation, [808](#)
- yellow
  - gdcM::terminal, [85](#)
- YES
  - gdcM::Surface, [1062](#)
- ZEROED\_OUT
  - gdcM::CSAHeader, [288](#)
- ZSpacing
  - gdcM::IPPSorter, [610](#)
- ZTolerance
  - gdcM::IPPSorter, [610](#)